

SR5150 THRU SR5200

List

List..... 1

Package outline..... 2

Features..... 2

Mechanical data..... 2

Maximum ratings2

Rating and characteristic curves..... 3

Pinning information.....4

Marking..... 4

Taping & bulk specifications for AXIAL devices..... 4

Suggested thermal profiles for soldering processes..... 5

High reliability test capabilities.....6

SR5150 THRU SR5200

5.0A Axial Leaded Schottky Barrier Rectifiers - 150V-200V

Features

- Axial lead type devices for through hole design
- Low power loss, high efficiency.
- High current capability, low forward voltage drop.
- High surge capability.
- Guardring for overvoltage protection.
- Ultra high-speed switching.
- Silicon epitaxial planar chip, metal silicon junction.
- Lead-free parts meet environmental standards of MIL-STD-19500 /228
- Suffix "-H" for Halogen-free part, ex. SR5150-H

Mechanical data

- Epoxy : UL94-V0 rated flame retardant
- Case : Molded plastic, DO-201AD
- Lead : Axial leads, solderable per MIL-STD-202, Method 208 guaranteed
- Polarity: Color band denotes cathode end
- Mounting Position : Any
- Weight : Approximated 1.10 gram

Package outline

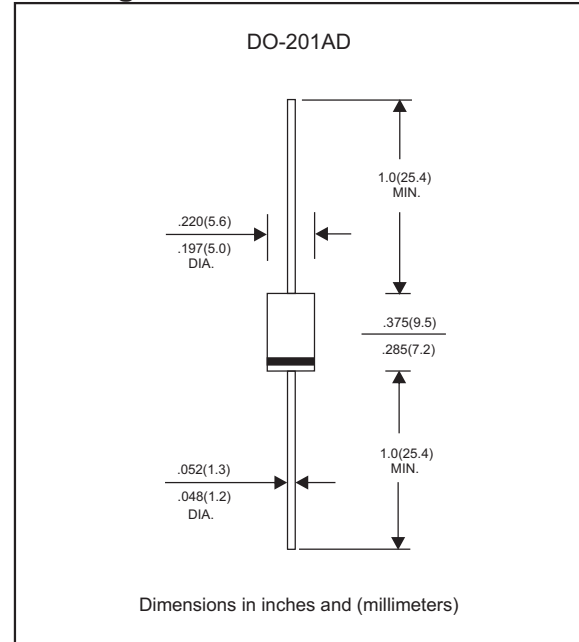

Maximum ratings and Electrical Characteristics (AT $T_A=25^\circ\text{C}$ unless otherwise noted)

PARAMETER	CONDITIONS	Symbol	MIN.	TYP.	MAX.	UNIT
Forward rectified current	See Fig.2	I_o			5.0	A
Forward surge current	8.3ms single half sine-wave (JEDEC method)	I_{FSM}			150	A
Reverse current	$V_R = V_{RRM}$ $T_J = 25^\circ\text{C}$	I_R			0.1	mA
	$V_R = V_{RRM}$ $T_J = 100^\circ\text{C}$				50	
Thermal resistance	Junction to ambient	$R_{\theta JA}$		10		$^\circ\text{C}/\text{W}$
Diode junction capacitance	$f=1\text{MHz}$ and applied 4V DC reverse voltage	C_J		150		pF
Storage temperature		T_{STG}	-65		+175	$^\circ\text{C}$

SYMBOLS	V_{RRM}^{*1} (V)	V_{RMS}^{*2} (V)	V_R^{*3} (V)	V_F^{*4} (V)	Operating temperature T_J , ($^\circ\text{C}$)
SR5150	150	105	150	0.90	
SR5200	200	140	200	0.92	

*1 Repetitive peak reverse voltage

*2 RMS voltage

*3 Continuous reverse voltage

*4 Maximum forward voltage@ $I_F=5.0\text{A}$

Rating and characteristic curves (SR5150 THRU SR5200)

FIG.1-TYPICAL FORWARD CURRENT DERATING CURVE

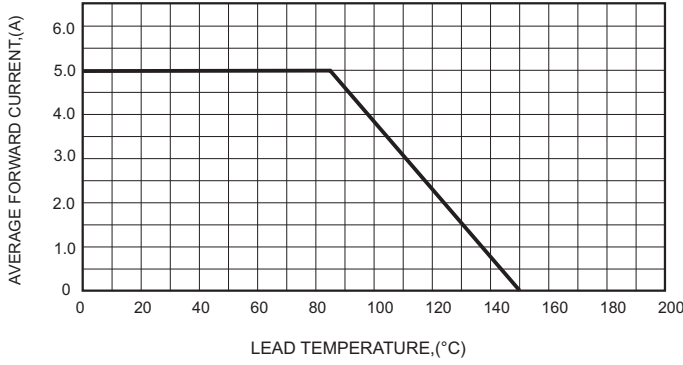

FIG.2-TYPICAL FORWARD CHARACTERISTICS

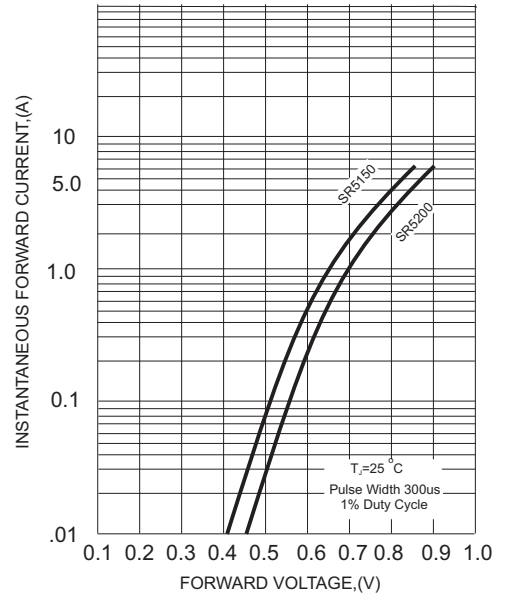

FIG.3-MAXIMUM NON-REPETITIVE FORWARD SURGE CURRENT

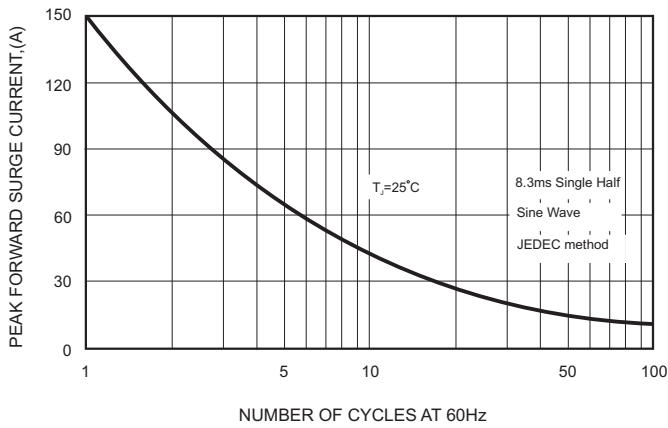

FIG.5 - TYPICAL REVERSE CHARACTERISTICS

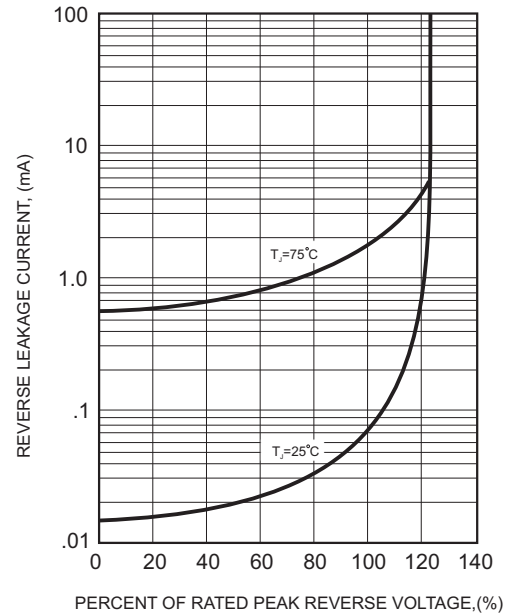
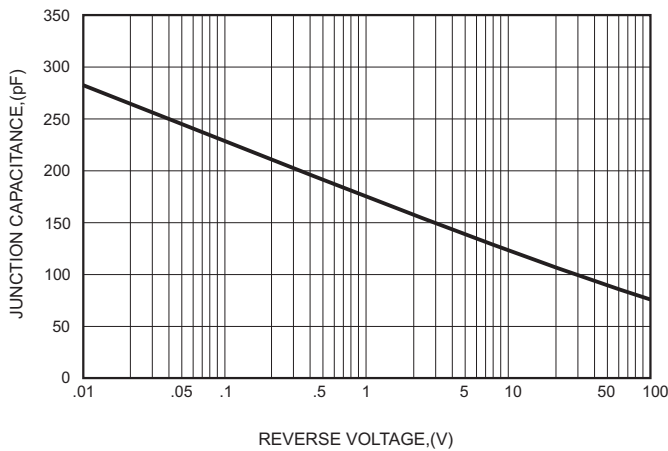



FIG.4-TYPICAL JUNCTION CAPACITANCE



SR5150 THRU SR5200

Pinning information

Pin	Simplified outline	Symbol
Pin1 cathode Pin2 anode		

Marking

Type number	Marking code
SR5150	SR5150
SR5200	SR5200

Taping & bulk specifications for AXIAL devices

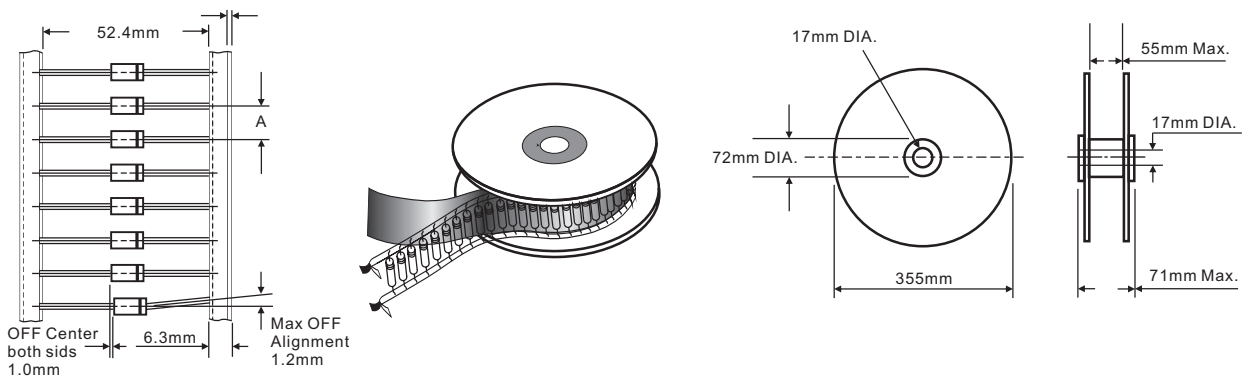

REEL PACKING

DEVICE CASE TYPE	Q'TY 1 (PCS / REEL)	COMPONENT SPACING "A" in FIG. A	CARTON SIZE (m/m)	Q'TY 2 (PCS / CARTON)	APPROX. CROSS WEIGHT(kg)
DO-201AD	1,200	10 mm	380 * 340 * 370	4,800	9.1

AMMO PACKING

DEVICE CASE TYPE	Q'TY 1 (PCS / BOX)	INNER BOX SIZE (m/m)	CARTON SIZE (m/m)	Q'TY 2 (PCS / CARTON)	APPROX. CROSS WEIGHT(kg)
DO-201AD	1,200	260 * 83 * 160	440 * 270 * 340	12,000	17.0

SR5150 THRU SR5200

BULK PACKING

DEVICE CASE TYPE	Q'TY 1 (PCS / BOX)	INNER BOX SIZE (m/m)	CARTON SIZE (m/m)	Q'TY 2 (PCS / CARTON)	APPROX. CROSS WEIGHT(kg)
DO-201AD	500	305 * 73 * 40	347 * 320 * 271	12,000	16.4

Suggested thermal profiles for soldering processes

1. Lead free temperature profile wave-soldering

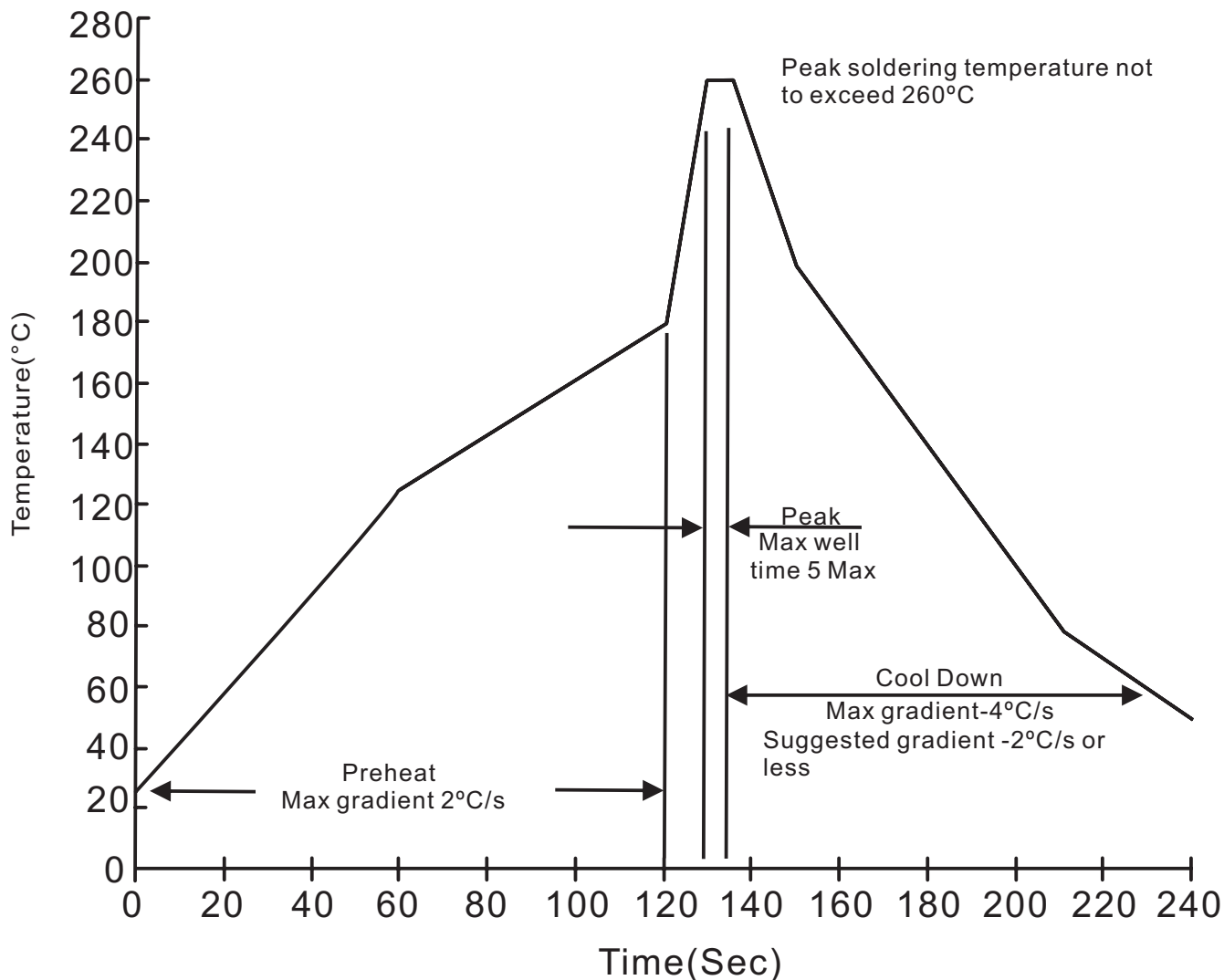

SR5150 THRU SR5200**High reliability test capabilities**

Item Test	Conditions	Reference
1. Solder Resistance	at 260±5°C for 10±2sec. immerse body into solder 1/16"±1/32"	MIL-STD-750D METHOD-2031
2. Solderability	at 245±5°C for 5 sec.	MIL-STD-202F METHOD-208
3. Pull Test	2.0kg in axial lead direction for 10 sec. $I_F = I_O$	MIL-STD-202F METHOD-211A
4. Bend Lead	2.0kg weight applied to each lead bending arc 90°±5° for 3 times	MIL-STD-202F METHOD-211A
5. High Temperature Reverse Bias	$V_R = 80\%$ rate at $T_J = 150^\circ\text{C}$ for 168 hrs.	MIL-STD-750D METHOD-1038
6. Forward Operation Life	Rated average rectifier current at $T_A = 25^\circ\text{C}$ for 500hrs. $T_A = 25^\circ\text{C}$, $I_F = I_O$	MIL-STD-750D METHOD-1027
7. Intermittent Operation Life	On state: power on for 5 min. off state: power off for 5 min, on and off for 500 cycles.	MIL-STD-750D METHOD-1036
8. Pressure Cooker	15P _{sig} at $T_A = 121^\circ\text{C}$ for 4 hrs.	JESD22-A102
9. Temperature Cycling	-55°C to +125°C dwelled for 30 min. and transferred for 5min. total 10 cycles.	MIL-STD-750D METHOD-1051
10. Forward Surge	8.3ms single half sine-wave one surge.	MIL-STD-750D METHOD-4066-2
11. Humidity	at $T_A = 85^\circ\text{C}$, RH=85% for 1000hrs.	MIL-STD-750D METHOD-1021
12. High Temperature Storage Life	at 175°C for 1000 hrs.	MIL-STD-750D METHOD-1031