

[Document Title](#)

2M x 16 bit Pseudo SRAM Specification

[Revision History](#)

Revision No.	History	Date	Remark
0.0	- Initial Draft	May. 21 2008	Preliminary
0.1	Revised tBA (70ns to 25ns)	Jun. 11 2008	
1.0	- EM7164SU16BLP, EM7164SU16BMP, EM7164SU16BNP, EM7164SU16BPP, EM7164SU16BRP & EM7164SU16BSP are unified to EM7164SU16BxP. - I _{CC1P} changed to I _{CCP} . - I _{CC1} (Cycle time=Min.) changed to I _{CC2} (Cycle time=Min.). - I _{CC1} (Cycle time=1us) added to DC AND OPERATING CHARACTERISTICS table in page 5.	Dec. 15 2008	Release
1.1	- Part name changed from EM7324SU16xP-70LF to EM7324SU16xP-70LFx - FEATURES & PRODUCT FAMILY updated in page 2. - ABSOLUTE MAXIMUM RATINGS table updated in page 4. - RECOMMENDED DC OPERATING CONDITIONS & DC AND OPERATING CHARACTERISTICS updated in page 5. - AC CHARACTERISTICS updated in page 6. - Note corrected in page 3 and 12. - PACKAGE DIMENSION modified in page 13. - MEMORY FUNCTION GUIDE updated in page 14.	Mar. 3 2009	
1.2	- Operating voltage changed to 2.6V~3.6V(typ:3.3V)	Mar. 25 2010	

2Mb x16 Pseudo Static RAM Specification

GENERAL DESCRIPTION

The EM7324SU16xP is 33,554,432 bits of Pseudo SRAM which uses DRAM type memory cells, but this device has refresh-free operation and extreme low power consumption technology. Furthermore the interface is compatible to a low power Asynchronous type SRAM. The EM7324SU16xP is organized as 2,097,152 Words x 16 bit.

FEATURES

- Organization :2M x16
- Power Supply Voltage : 2.6 ~ 3.6V
- Separated I/O power(VccQ) & Core power(Vcc)
- Three state outputs
- Byte read/write control by UB# / LB#
- Auto-TCSR for power saving
- Package type : 48-FPBGA 6.0x7.0
- Operating Temperature
 - . Extended : -25°C ~ 85°C
 - . Wireless : -30°C ~ 85°C
 - . Industrial : -40°C ~ 85°C
- EM7324SU16LP support 8 page mode & DPD
- EM7324SU16MP support 8 page mode & Non-DPD
- EM7324SU16NP support 16 page mode & DPD
- EM7324SU16PP support 16 page mode & Non-DPD
- EM7324SU16RP support Non-page mode & DPD
- EM7324SU16SP support Non-page mode & Non-DPD

PRODUCT FAMILY

Part Number	Operating Temp.	Power Supply	Speed (t _{RC})	Power Dissipation		
				Standby (I _{SB} , Max.)	Operating I _{CC} (Max.)	
					I _{CC1} (f = 1MHz)	I _{CC2} (f = f _{max})
EM7324SU16xP-70LF	-25°C to 85°C	2.6V to 3.6V	70ns	120uA	5mA	25mA
EM7324SU16xP-70LFW	-30°C to 85°C	2.6V to 3.6V	70ns	120uA	5mA	25mA
EM7324SU16xP-70LFI	-40°C to 85°C	2.6V to 3.6V	70ns	120uA	5mA	25mA

FUNCTION BLOCK DIAGRAM

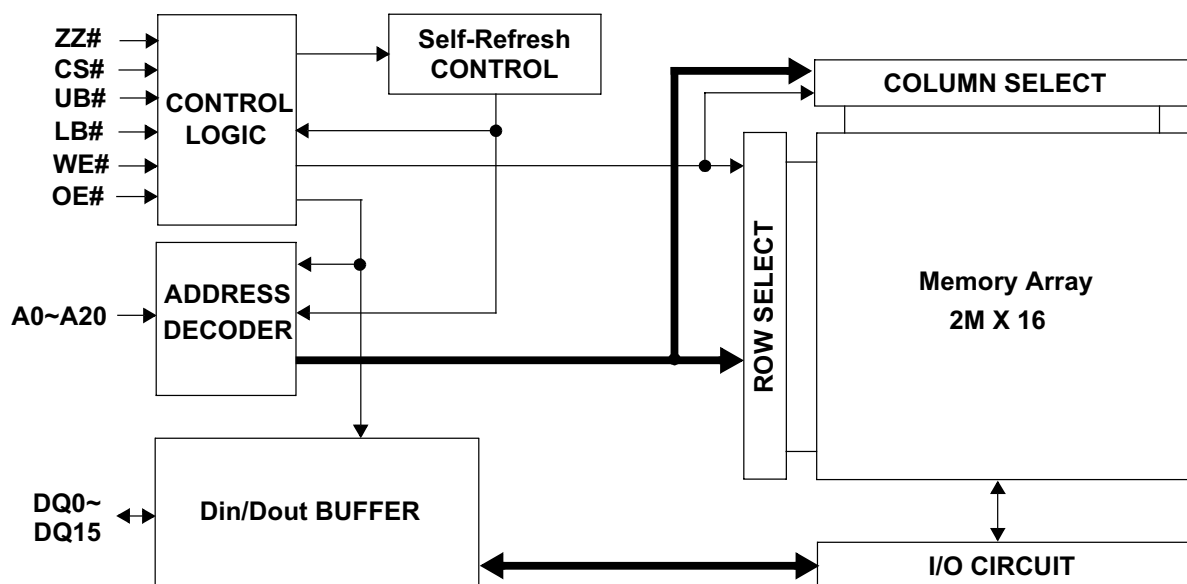

PIN DESCRIPTION (48-FBGA-6.00x7.00)

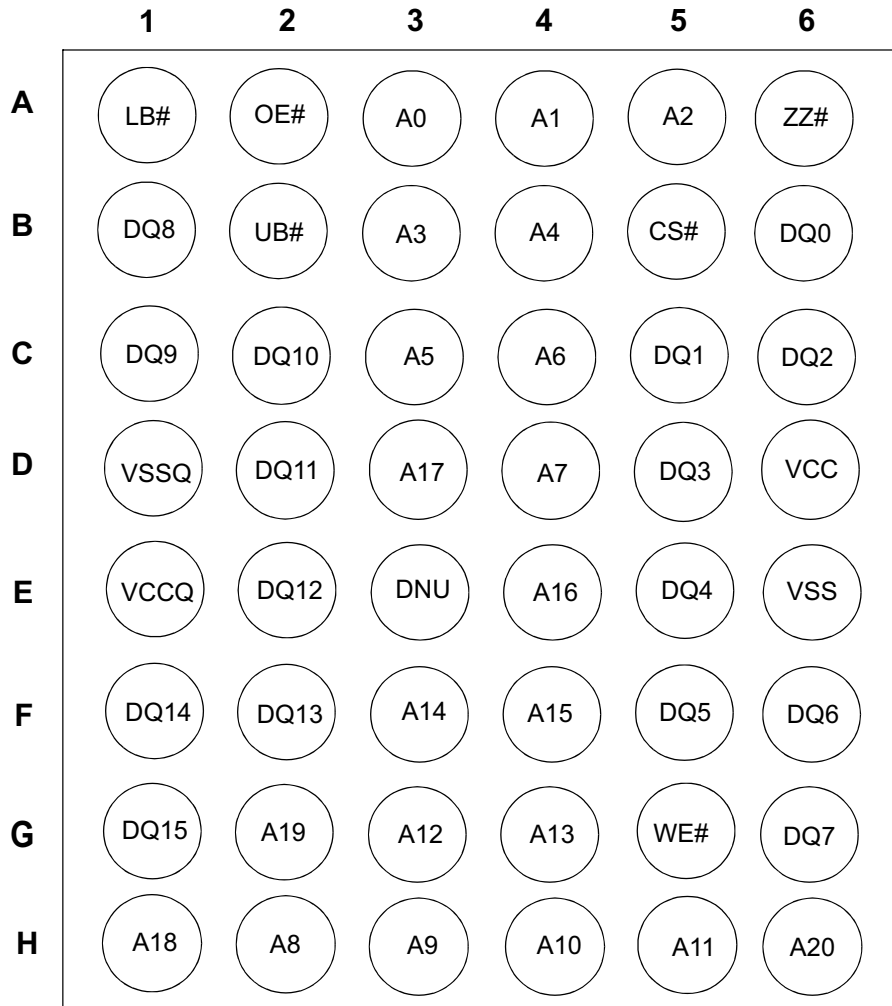

TOP VIEW (Ball Down)

Name	Function	Name	Function
CS#	Chip select input	LB#	Lower byte (DQ ₀₋₇)
OE#	Output enable input	UB#	Upper byte (DQ ₈₋₁₅)
WE#	Write enable input	VCC	Power supply
ZZ#	Low power control	VCCQ	I/O power supply
DQ ₀₋₁₅	Data in-out	VSS(Q)	Ground
A ₀₋₂₀	Address inputs	NC	No connection
DNU	Do not use		

Note : ZZ# pin is replaced to NC pin in EM7324SU16MP, EM7324SU16PP, EM7324SU16SP.

ABSOLUTE MAXIMUM RATINGS ¹⁾

Parameter		Symbol	Ratings	Unit
Voltage on Any Pin Relative to Vss		V_{IN}, V_{OUT}	-0.2 to $V_{CCQ}+0.3V$	V
Voltage on Vcc supply relative to Vss		V_{CC}, V_{CCQ}	-0.2 ²⁾ to 4.0V	V
Power Dissipation		P_D	1.0	W
Storage Temperature		T_{STG}	-65 to 150	°C
Operating Temperature	Extended	T_A	-25 to 85	°C
	Wireless		-30 to 85	°C
	Industrial		-40 to 85	°C

- Stresses greater than those listed above "Absolute Maximum Ratings" may cause permanent damage to the device. Functional operation should be restricted to recommended operating condition. Exposure to absolute maximum rating conditions for extended periods may affect reliability.
- Undershoot at power-off : -1.0V in case of pulse width $\leq 20ns$

FUNCTIONAL DESCRIPTION

CS#	ZZ#	OE#	WE#	LB#	UB#	DQ _{0~7}	DQ _{8~15}	Mode	Power
H	H	X	X	X	X	High-Z	High-Z	Deselected	Stand by
X	L	X	X	X	X	High-Z	High-Z	Deselected	Low Power Mode* ²⁾
L	H	H	H	L	X	High-Z	High-Z	Output Disabled	Active
L	H	H	H	X	L	High-Z	High-Z	Output Disabled	Active
L	H	L	H	L	H	Data Out	High-Z	Lower Byte Read	Active
L	H	L	H	H	L	High-Z	Data Out	Upper Byte Read	Active
L	H	L	H	L	L	Data Out	Data Out	Word Read	Active
L	H	X	L	L	H	Data In	High-Z	Lower Byte Write	Active
L	H	X	L	H	L	High-Z	Data In	Upper Byte Write	Active
L	H	X	L	L	L	Data In	Data In	Word Write	Active

Note:

- X means don't care. (Must be low or high state)
- This Low Power mode is supported in EM7324SU16LP, EM7324SU16NP & EM7324SU16RP.

RECOMMENDED DC OPERATING CONDITIONS

Parameter	Symbol	Min	Typ	Max	Unit
Supply voltage	V_{CC}	2.6	3.3	3.6	V
	V_{CCQ}	2.6	3.3	3.6	V
Ground	V_{SS}, V_{SSQ}	0	0	0	V
Input high voltage	V_{IH}	$0.8 * V_{CCQ}$	-	$V_{CCQ} + 0.2^1)$	V
Input low voltage	V_{IL}	$-0.2^2)$	-	$0.2 * V_{CCQ}$	V

1. Overshoot: $V_{CC} + 1.0$ V in case of pulse width ≤ 20 ns
2. Undershoot: -1.0 V in case of pulse width ≤ 20 ns
3. Overshoot and undershoot are sampled, not 100% tested.

CAPACITANCE¹⁾ ($f=1$ MHz, $T_A=25^\circ$ C)

Item	Symbol	Test Condition	Min	Max	Unit
Input capacitance	C_{IN}	$V_{IN}=0V$	-	8	pF
Input/Output capacitance	C_{IO}	$V_{IO}=0V$	-	8	pF

1. Capacitance is sampled, not 100% tested

DC AND OPERATING CHARACTERISTICS

Parameter	Symbol	Test Conditions	Min	Typ	Max	Unit
Input leakage current	I_{LI}	$V_{IN}=V_{SS}$ to V_{CCQ} , $V_{CC}=V_{CCmax}$	-1	-	1	μ A
Output leakage current	I_{LO}	$CS\#=V_{IH}$, $ZZ\#=V_{IH}$, $OE\#=V_{IH}$ or $WE\#=V_{IL}$, $V_{IO}=V_{SS}$ to V_{CCQ} , $V_{CC}=V_{CCmax}$	-1	-	1	μ A
Average operating current	I_{CC1}	Cycle time = 1 μ s, $I_{IO}=0$ mA, 100% duty, $CS\#\leq 0.2V$, $ZZ\#\geq V_{CCQ}-0.2V$, $V_{IN}\leq 0.2V$ or $V_{IN}\geq V_{CCQ}-0.2V$	-	-	5	mA
	I_{CC2}	Cycle time = Min, $I_{IO}=0$ mA, 100% duty, $CS\#=V_{IL}$, $ZZ\#=V_{IH}$, $V_{IN}=V_{IL}$ or V_{IH}	-	-	25	mA
Page access operating current	I_{CCP}	$t_{PC} = \text{Min}$, $CS\#=V_{IL}$, $ZZ\#=V_{IH}$, $I_{IO}=0$ mA, Page add. cycling.	-	-	15	mA
Output low voltage	V_{OL}	$I_{OL} = 0.5$ mA, $V_{CC}=V_{CCmin}$	-	-	$0.2 * V_{CCQ}$	V
Output high voltage	V_{OH}	$I_{OH} = -0.5$ mA, $V_{CC}=V_{CCmin}$	$0.8 * V_{CCQ}$	-	-	V
Standby current (CMOS)	I_{SB}	$CS\#, ZZ\#\geq V_{CCQ}-0.2V$, Other inputs = 0 ~ V_{CCQ} (Typ. condition : $V_{CC}=3.3V$ @ 25° C) (Max. condition : $V_{CC}=3.6V$ @ 85° C)	-	-	120	μ A

1. Maximum I_{CC} specifications are tested with $V_{CC} = V_{CCmax}$.

AC OPERATING CONDITIONS

Test Conditions (Test Load and Test Input/Output Reference)

Input Pulse Level : 0.2V to $V_{CCQ}-0.2V$

Input Rise and Fall Time : 5ns

Input and Output reference Voltage : $V_{CCQ}/2$

Output Load (See right) : $CL^{(1)} = 30pF$

1. Including scope and Jig capacitance

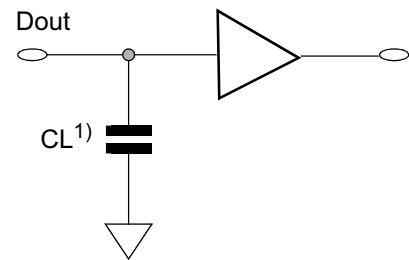

AC CHARACTERISTICS

Parameter List		Symbol	Speed		Unit
			Min	Max	
Read	Read Cycle Time	t_{RC}	70	10k	ns
	Address access time	t_{AA}	-	70	ns
	Chip enable to data output	t_{CO}	-	70	ns
	Output enable to valid output	t_{OE}	-	25	ns
	UB#, LB# enable to data output	t_{BA}	-	25	ns
	Chip enable to low-Z output	t_{LZ}	10	-	ns
	UB#, LB# enable to low-Z output	t_{BLZ}	0	-	ns
	Output enable to low-Z output	t_{OLZ}	0	-	ns
	Chip disable to high-Z output	t_{HZ}	0	20	ns
	UB#, LB# disable to high-Z output	t_{BHZ}	0	20	ns
	Output disable to high-Z output	t_{OHZ}	0	20	ns
	Output hold from Address change	t_{OH}	5	-	ns
Write	Write Cycle Time	t_{WC}	70	10k	ns
	Chip enable to end of write	t_{CW}	60	-	ns
	Address setup time	t_{AS}	0	-	ns
	Address valid to end of write	t_{AW}	60	-	ns
	UB#, LB# valid to end of write	t_{BW}	60	-	ns
	Write pulse width	t_{WP}	50	-	ns
	Write recovery time	t_{WR}	0	-	ns
	Write to output high-Z	t_{WHZ}	0	20	ns
	Data to write time overlap	t_{DW}	20	-	ns
	Data hold from write time	t_{DH}	0	-	ns
	End write to output low-Z	t_{OW}	5	-	ns
Page	Maximum cycle time	$t_{MRC}^{*1)}$	-	10k	ns
	Page mode cycle time	$t_{PC}^{*1)}$	25	-	ns
	Page mode address access time	$t_{PAA}^{*1)}$	-	25	ns

NOTES

1. These parameters are not supported in EM7324SU16RP & EM7324SU16SP.

TIMING DIAGRAMS

READ CYCLE (1) (Address controlled, CS#=OE#=V_{IL}, ZZ#=WE#=V_{IH}, UB# or/and LB#=V_{IL})

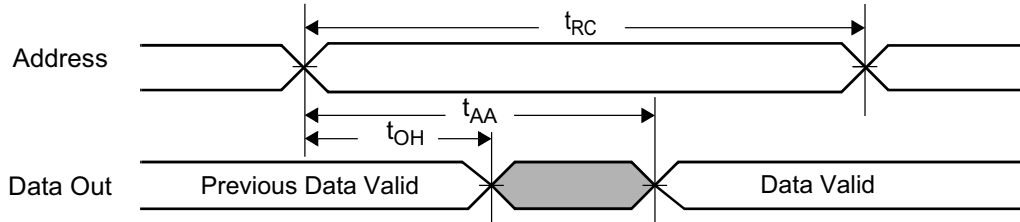

READ CYCLE (2) (ZZ#=WE#=V_{IH})

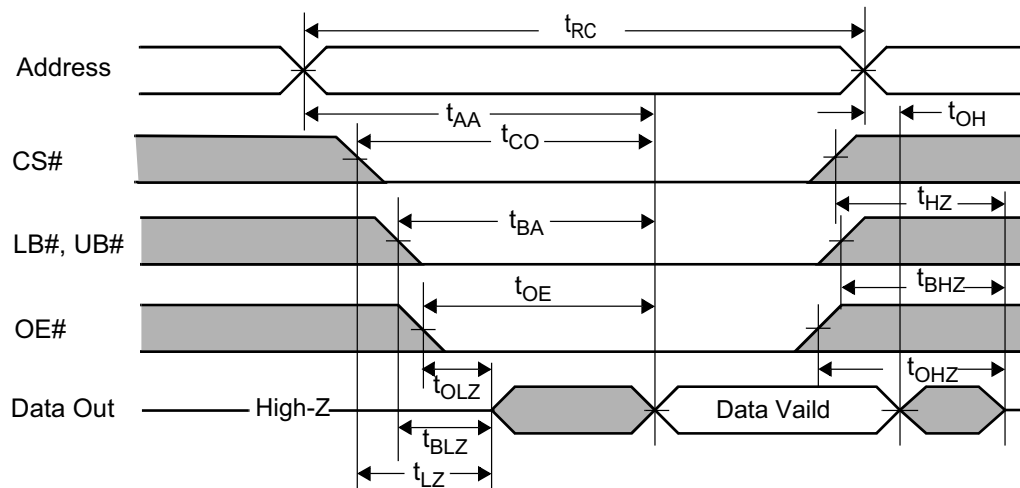

NOTES (READ CYCLE)

1. t_{HZ} , t_{BHZ} and t_{OHZ} are defined as the time at which the outputs achieve the open circuit conditions and are not referenced to output voltage levels.
2. Do not Access device with cycle timing shorter than t_{RC} for continuous periods > 10us.

PAGE READ CYCLE (1) (ZZ#=WE#=V_{IH}, 8 Words access)

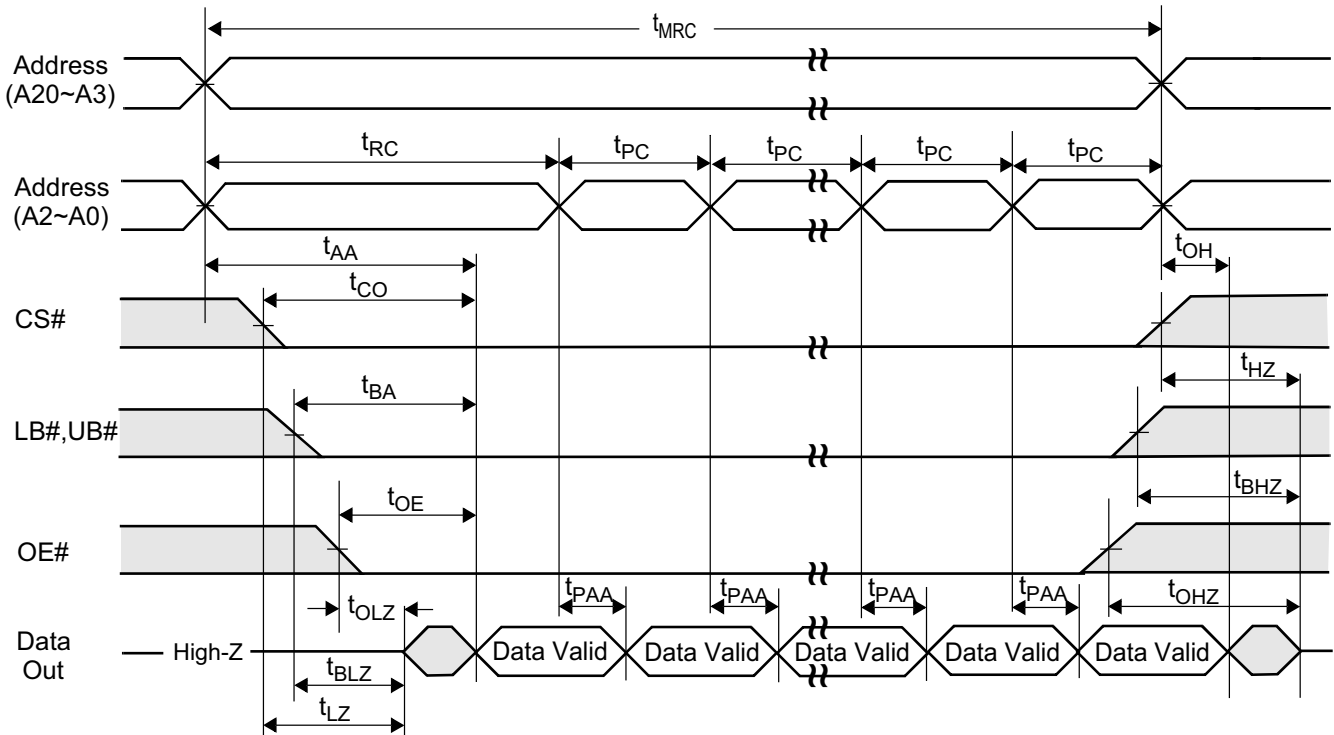

NOTES (READ CYCLE)

1. t_{HZ}, t_{BHZ} and t_{OHZ} are defined as the time at which the outputs achieve the open circuit conditions and are not referenced to output voltage levels.
2. Do not Access device with cycle timing shorter than t_{RC} for continuous periods > 10us.
3. This page read cycle(8 page mode) is supported in EM7324SU16LP & EM7324SU16MP.

PAGE READ CYCLE (2) (ZZ#=WE#=V_{IH}, 16 Words access)

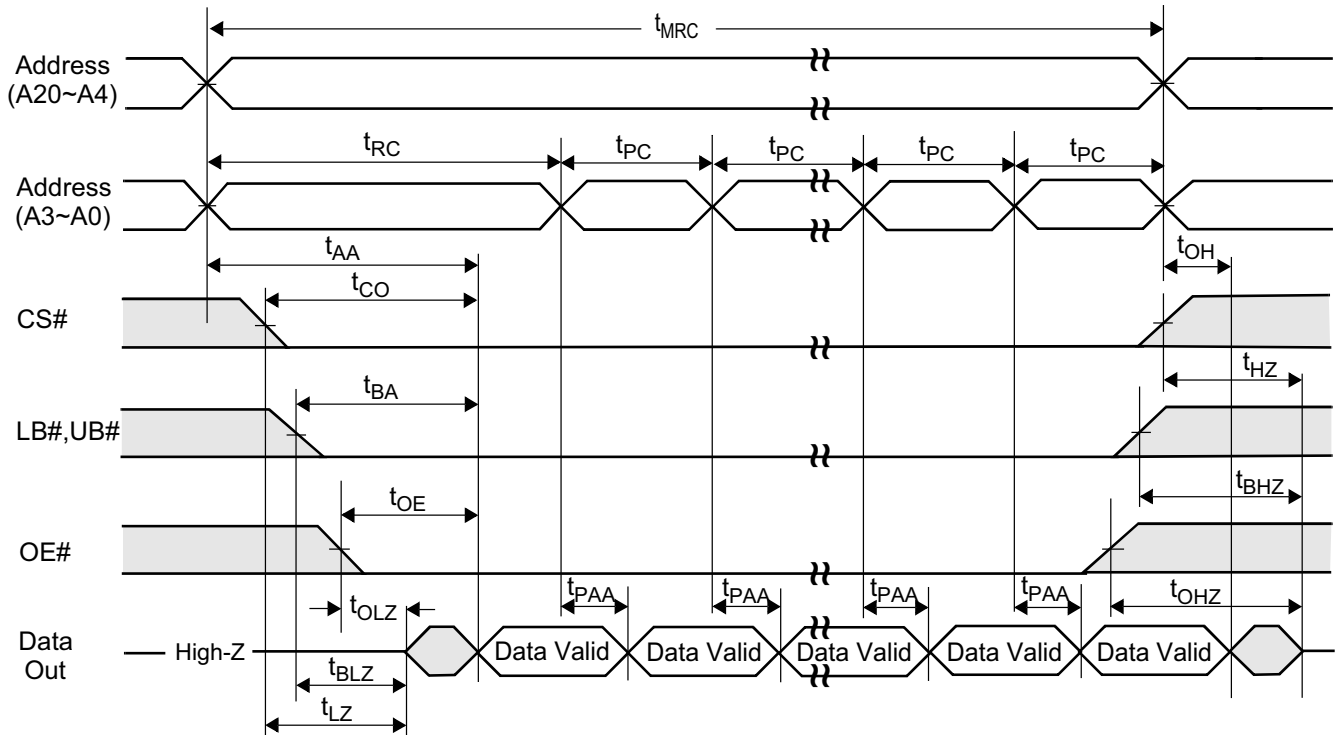

NOTES (READ CYCLE)

1. t_{HZ} , t_{BHZ} and t_{OHZ} are defined as the time at which the outputs achieve the open circuit conditions and are not referenced to output voltage levels.
2. Do not Access device with cycle timing shorter than t_{RC} for continuous periods > 10us.
3. This page read cycle(16 page mode) is supported in EM7324SU16NP & EM7324SU16PP.

WRITE CYCLE (1) (WE# controlled, ZZ#=V_{IH})

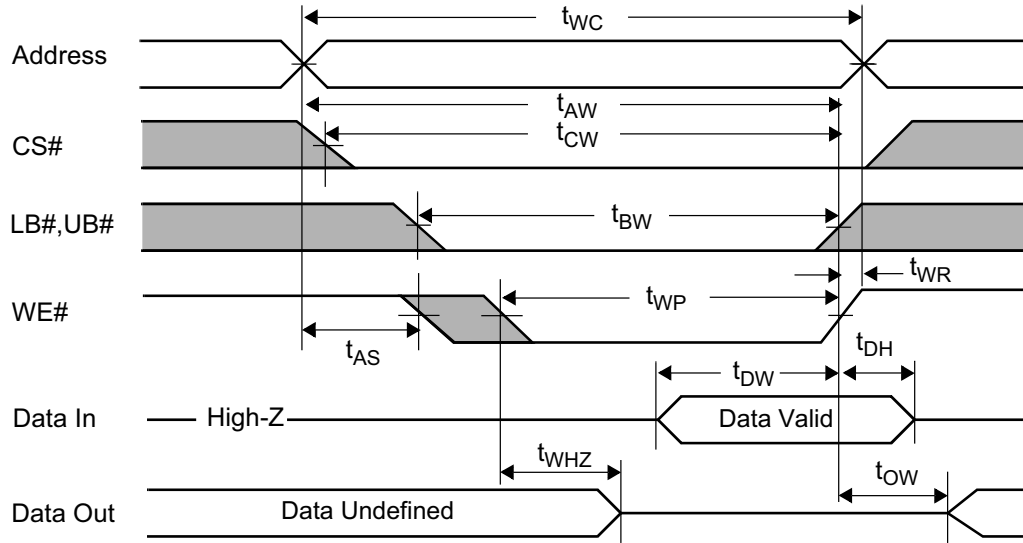

WRITE CYCLE (2) (CS# controlled, ZZ#=V_{IH})

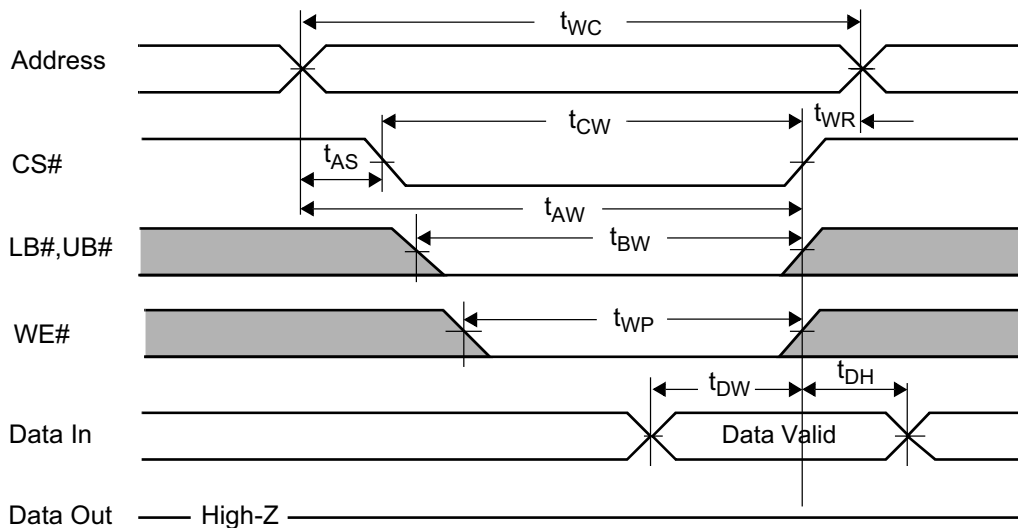

WRITE CYCLE (3) (UB#/LB# controlled, ZZ#=V_{IH})

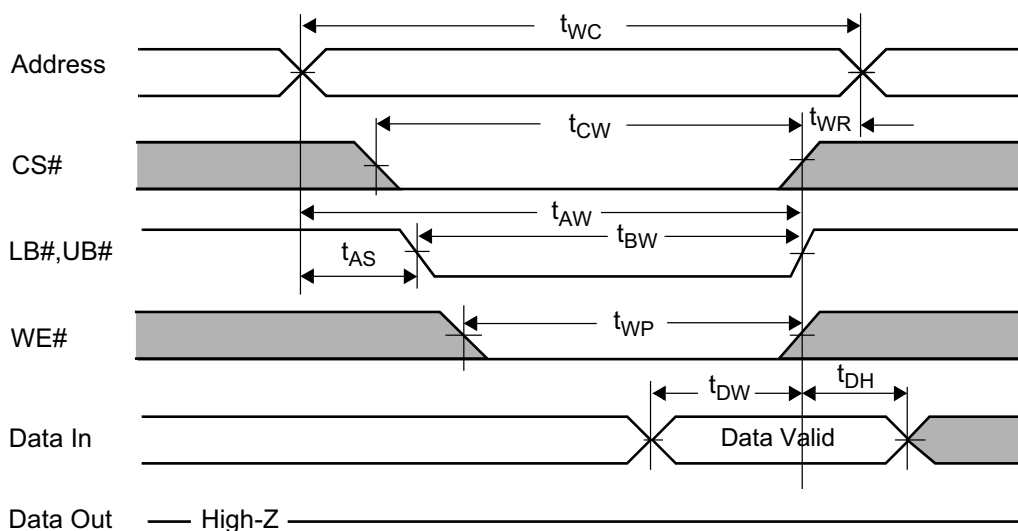

NOTES (WRITE CYCLE)

1. A write occurs during the overlap (t_{WP}) of low CS#, low WE# and low UB# or LB#. A write begins at the last transition among low CS# and low WE# with asserting UB# or LB# low for single byte operation or simultaneously asserting UB# and LB# low for word operation. A write ends at the earliest transition among high CS# and high WE#. The t_{WP} is measured from the beginning of write to the end of write.
2. t_{CW} is measured from CS# going low to end of write.
3. t_{AS} is measured from the address valid to the beginning of write.
4. t_{WR} is measured from the end of write to the address change. t_{WR} applied in case a write ends as CS# or WE# going high.
5. Do not access device with cycle timing shorter than t_{WC} for continuous periods > 10us.

LOW POWER MODES

Deep Power Down Mode Entry/Exit

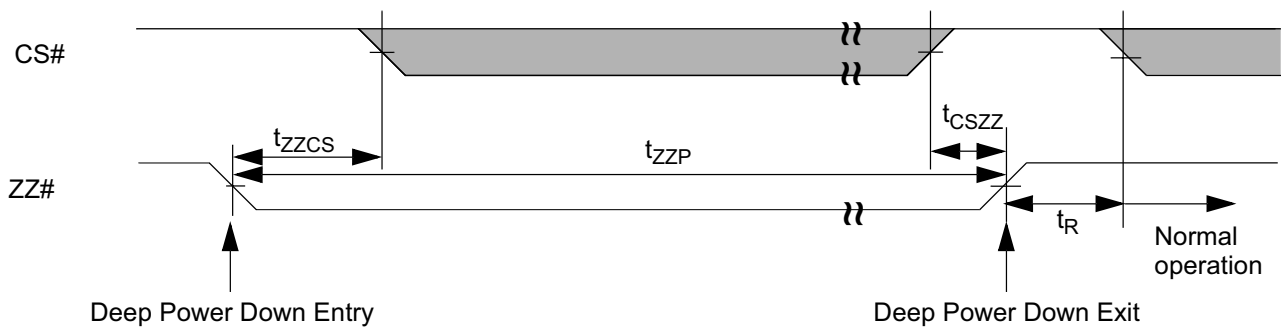

NOTES (DEEP POWER DOWN)

1. During Deep Power Down mode, all refresh related activity are disabled.
2. This DPD mode is supported in EM7324SU16LP, EM7324SU16NP & EM7324SU16RP.

Parameter	Description	Min.	Max.	Units
t_{ZZCS}	ZZ# low to CS# low	0	-	ns
t_{CSZZ}	CS# high to ZZ# high	0	-	ns
t_R	Operation Recovery Time	200	-	us
t_{ZZP}	ZZ# pulse width	20	-	ns

Low Power Mode Characteristics

Parameter	Symbol	Test Conditions	Min	Typ	Max	Unit
Deep Power Down Current	I_{ZZ}	ZZ# $\leq 0.2V$, Other inputs = 0 ~ V_{CCQ} (Max. condition : $V_{CC}=3.6V @ 85^\circ C$)	-	-	10	μA

TIMING WAVEFORM OF POWER UP

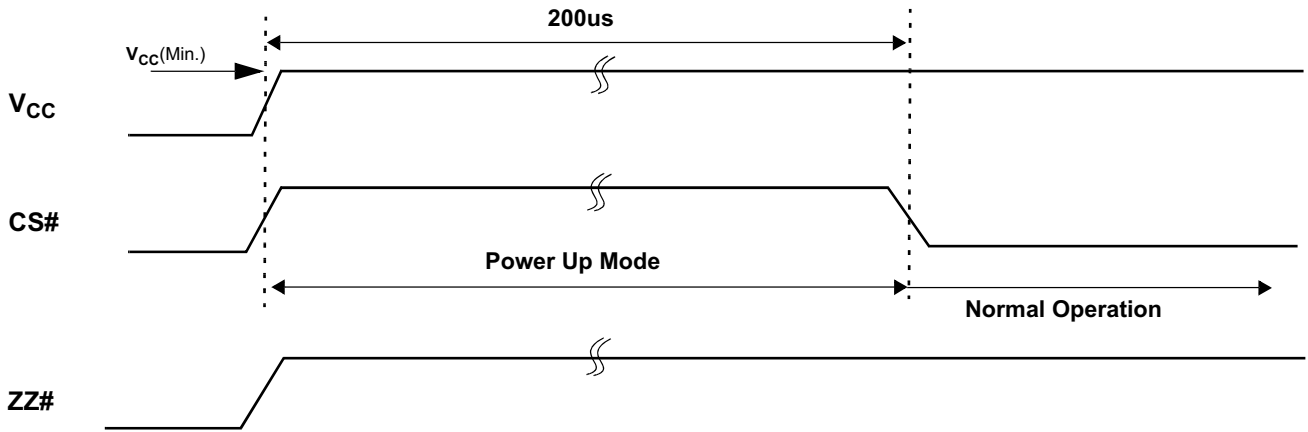

NOTE (POWER UP)

1. After V_{CC} reaches $V_{CC(Min.)}$, wait 200us with $CS\#$ high. Then you get into the normal operation.
2. $ZZ\#$ pin is replaced to NC pin in EM7324SU16MP, EM7324SU16PP, EM7324SU16SP.

PACKAGE DIMENSION

48 Ball Fine Pitch BGA (0.75mm ball pitch)

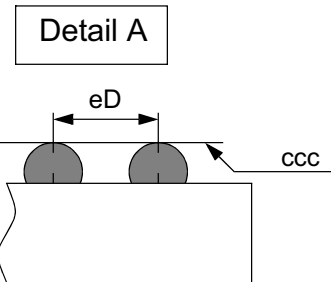
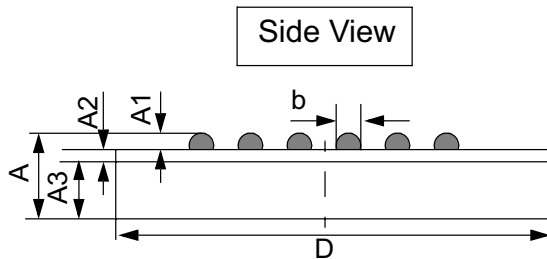
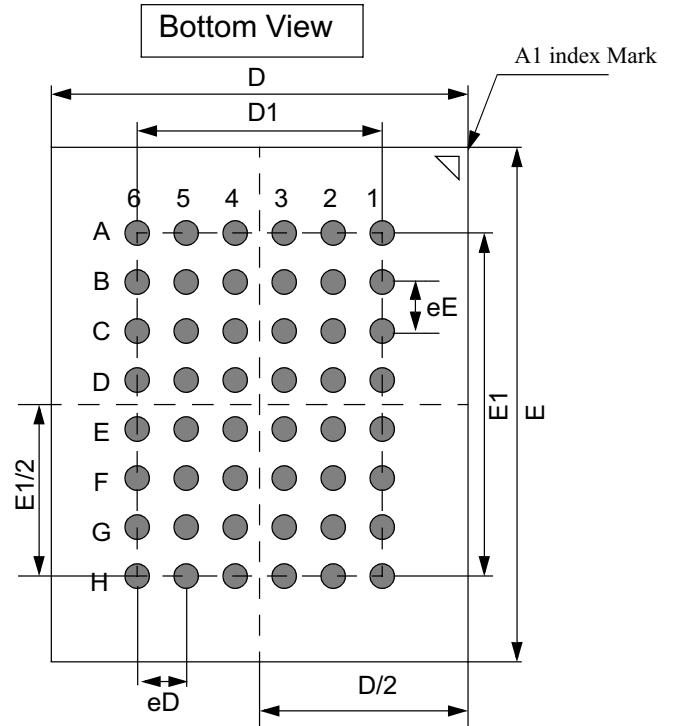
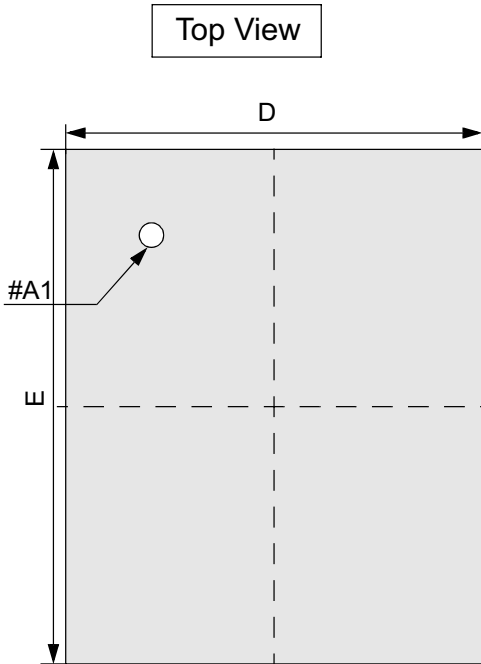

	Min	Typ	Max
A	-	-	1.00
A1	0.22	-	0.32
A2	-	0.21	-
A3	-	0.45	-
b	0.32	-	0.42
D	5.90	6.00	6.10
E	6.90	7.00	7.10
D1	-	3.75	-
E1	-	5.25	-
eE	-	0.75	-
eD	-	0.75	-
ccc	-	-	0.08

NOTES.

1. Bump counts : 48(8row x 6column)
2. Bump pitch : (x,y)=(0.75x0.75) (typ.)
3. All tolerance are +/-0.050 unless otherwise specified.
4. Typ : Typical
5. ccc is coplanarity : 0.08(Max)

MEMORY FUNCTION GUIDE

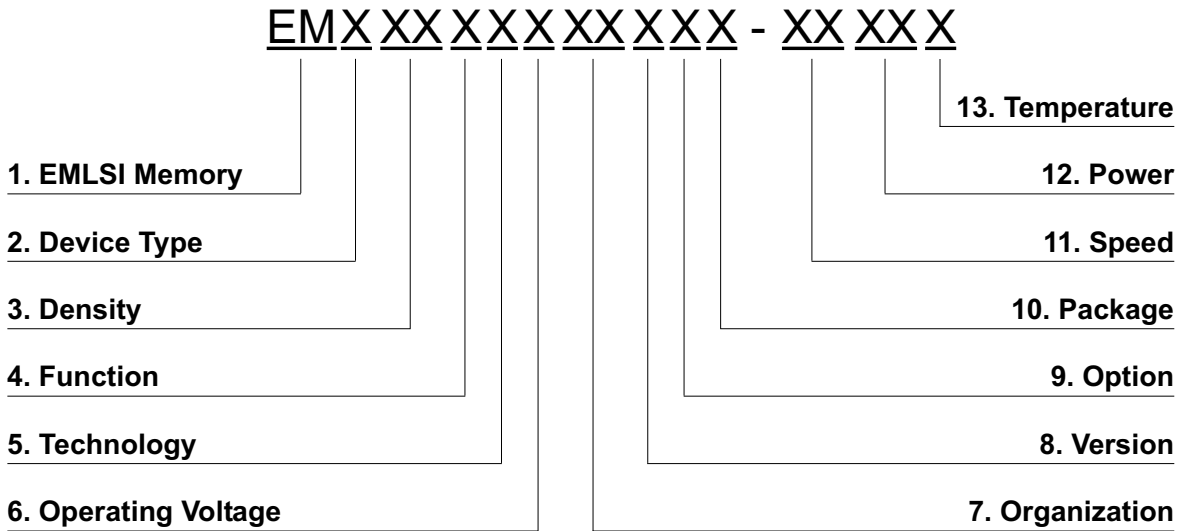

- 1. Memory Component
- 2. Device Type
 - 6 ----- Low Power SRAM
 - 7 ----- STRAM
 - C ----- CellularRAM
- 3. Density
 - 4 ----- 4M
 - 8 ----- 8M
 - 16 ----- 16M
 - 32 ----- 32M
 - 64 ----- 64M
 - 28 ----- 128M
- 4. Function
 - 2 ----- Multiplexed async.
 - 3 ----- Multiplexed sync.
 - 4 ----- Demultiplexed async.
 - 5 ----- Multiplexed sync.
 - 6 ----- Demultiplexed sync.
- 5. Technology
 - S ----- Single Transistor
- 6. Operating Voltage
 - V ----- 3.3V
 - U ----- 3.0V
 - S ----- 2.5V
 - R ----- 2.0V
 - P ----- 1.8V
 - L ----- 1.5V
- 7. Organization
 - 8 ----- X8 bit
 - 16 ----- X16 bit
 - 32 ----- X32 bit
- 8. Version
 - Blank ----- Mother die
 - A ----- 2 nd generation
 - B ----- 3 rd generation
 - C ----- 4 th generation
 - D ----- 5 th generation

- 9. Option
 - Blank ----- No optional mode
 - J ----- Non-RBC
 - K ----- RBC
 - L ----- 8 page mode / DPD
 - M ----- 8 page mode / Non-DPD
 - N ----- 16 page mode / DPD
 - P ----- 16 page mode / Non-DPD
 - R ----- Non-page mode / DPD
 - S ----- Non-page mode / Non-DPD
- 10. Package
 - Blank ----- Wafer
 - S ----- 32 sTSOP1
 - T ----- 32 TSOP1
 - U ----- 44 TSOP2
 - P ----- 48 FPBGA
 - Z ----- 52 FPBGA
 - Y ----- 54 FPBGA
 - W ----- 60 FPBGA
 - V ----- 90 FPBGA
- 11. Speed(@async.)
 - 45 ----- 45ns
 - 55 ----- 55ns
 - 60 ----- 60ns
 - 70 ----- 70ns
 - 85 ----- 85ns
 - 90 ----- 90ns
 - 10 ----- 100ns
 - 12 ----- 120ns
- 12. Power
 - LL ----- Low Low Power
 - LF ----- Low Low Power(Pb-free & Green)
 - L ----- Low Power
 - S ----- Standard Power
- 13. Temperature
 - Blank ----- Extended (-25℃ ~ 85℃)
 - W ----- Wireless (-30℃ ~ 85℃)
 - I ----- Industrial (-40℃ ~ 85℃)