



**Lead-Free Current Sensing Resistors
RLM Series
(Halogen-Free)**

Document No	TRLM-250S147D
Issued date	2013/07/02
Page	1/6

1. Scope :

This specification applied to the products of Lead-Free current sensing resistor of metal foil for Lead-Free RLM series manufactured by TA-I TECHNOLOGY CO.,LTD.

2. Type Designation :

<u>RLM</u> Item	<u>25</u> Series No.	<u>F</u> Resistance tolerance	<u>E</u> Packaging	<u>C</u> Power rating	<u>R010</u> Resistance
	25:2512 (6432)	F:±1% G:±2% J:±5%	E: Embossed Tape	C=1W D=1.5W E=2W	e.g : R003=3mΩ R010=10mΩ

3. Construction and Dimension :

3.1 Construction:

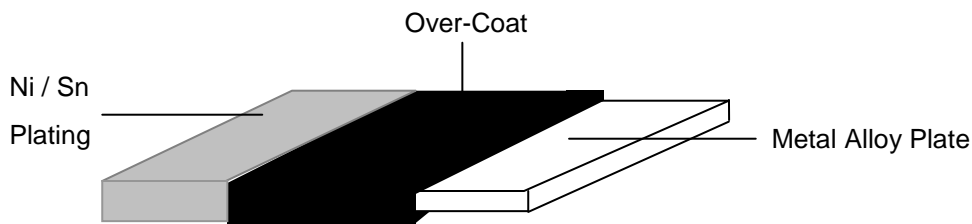

3.2 Dimension:

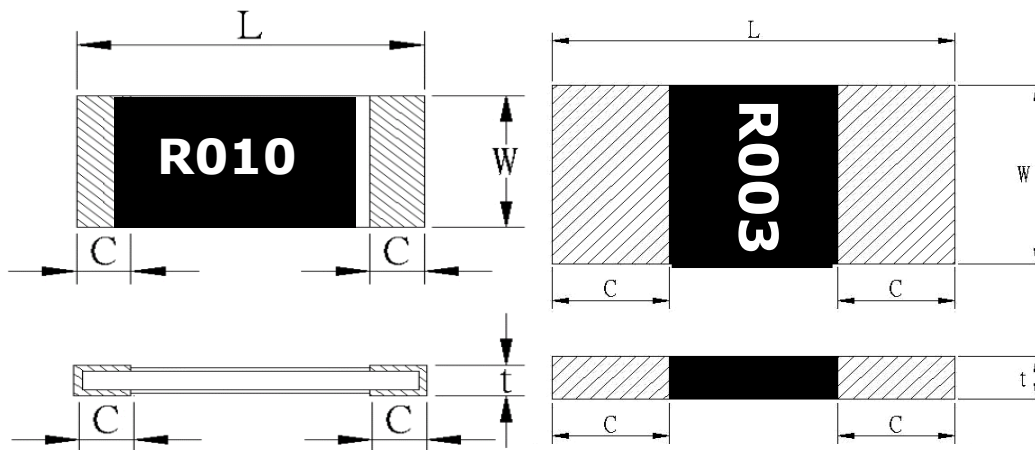

UNIT: mm

Style	L	W	C	t	Material
RLM25	6.4±0.2	3.2±0.2	2.0±0.2(R ≤ 3mΩ)	0.6 ±0.20	Strip : Alloy Over Coating : molding Compound UL-94 grade
			0.9±0.2(R > 3mΩ)		



Lead-Free Current Sensing Resistors
RLM Series
(Halogen-Free)

Document No	TRLM-250S147D
Issued date	2013/07/02
Page	2/6

4. Features:

Type	RLM	
Power Rating	(1W:R=1mΩ~50mΩ) (1.5W:R≤15 mΩ) (2W:R≤10mΩ)	
Resistance Value	1mΩ~50mΩ	
Operation Temperature Range	-55℃~+170℃	
Temperature Coefficient of Resistance	±275ppm/℃	R≤1mΩ
	±100ppm/℃	1mΩ<R≤10mΩ
	±75ppm/℃	R>10mΩ
Tolerance	±1%,±2%,±5%	
Insulation Resistance	Over 100MΩ	
Maximum Working Voltage(V)	(P*R) ^{1/2}	

5. Reliability Tests :

Test Items	Reference standard	Condition of Test	Test Limits
Temperature Coefficient of Resistance	IEC60115-1 4.8 JIS C 5201-1 4.8	+25℃ ~ +125℃	Refer 4.0
Load Life	IEC60115-1 4.25.1 JIS C 5201-1 4.25.1	1000hours at rated power, 70℃, 1.5hours "ON", 0.5hour "OFF"	< ±1%
Short Time Overload	IEC60115-1 4.13 JIS C 5201-1 4.13	5 X rated power for 5s	< ±0.5%
Moisture no Load	IEC60115-1 4.24.2.1a) JIS C 5201-1 4.24.2.1a)	85℃, 85%RH, 1000hrs	< ±1%
Temperature cycle	IEC60115-1 4.19 JIS C 5201-1 4.19	-55℃ & +155℃, 300cycle, 15min per extreme condition	< ±0.5%
Resistance to Soldering Heat	IEC60115-1 4.18 JIS C 5201-1 4.18	260±5℃ for20±1 sec	< ±0.5%
Solderability	IEC60115-1 4.17 JIS C 5201-1 4.17	245±5℃, 2±0.5sec	At least 95% of surface area of electrode shall be covered with new solder
High Temperature Exposure	IEC60115-1 4.23.2 JIS C 5201-1 4.23.2	170℃, 1000hrs	< ±1%
Low Temperature Storage	IEC60115-1 4.23.4 JIS C 5201-1 4.23.4	-55℃, 1000hrs	<±0.5%
Substrate Bending	IEC60115-1 4.33 JIS C 5201-1 4.33	Bending width 2mm	< ±0.5%
Insulation Resistance	IEC60115-1 4.6 JIS C 5201-1 4.6	100V DC for 1 minute	>100 MΩ



**Lead-Free Current Sensing Resistors
RLM Series
(Halogen-Free)**

Document No	TRLM-250S147D
Issued date	2013/07/02
Page	3/6

5.1 Derating Curve

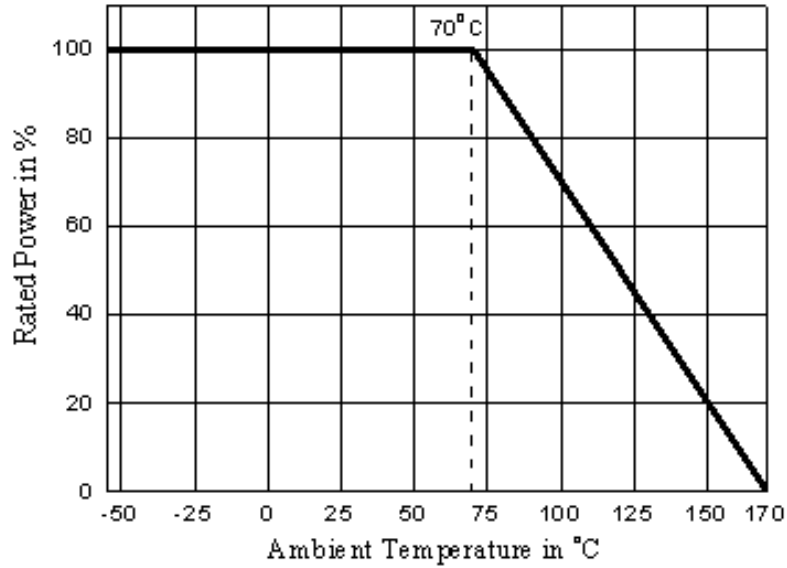

5.2 Rated Voltage

The rated voltage is calculated by the following fomula:

$$V = \sqrt{P \times R}$$

V:Rated Voltage(V)

P:Rated Power(W)

R:Resistance Value(Ω)

6. Recommended Solder Pad Dimension

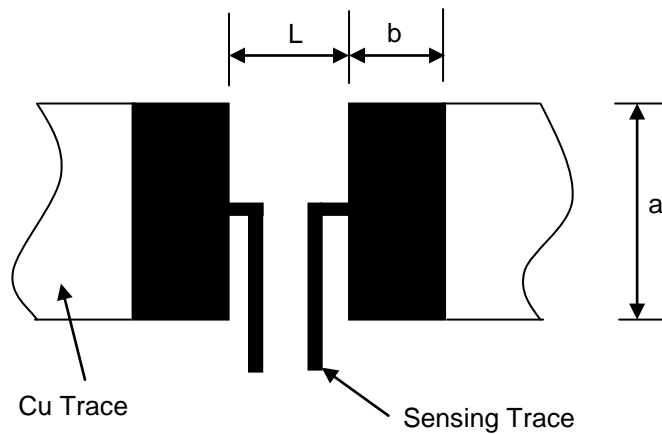

Resistance Range (Ω)	a	b	L
0.001-0.003	4.0	3.1	1.3
0.004-0.050	4.0	2.1	4.1

Unit: mm



**Lead-Free Current Sensing Resistors
RLM Series
(Halogen-Free)**

Document No	TRLM-250S147D
Issued date	2013/07/02
Page	4/6

7. Number of Package:

4000 Pieces / package

8. Label:

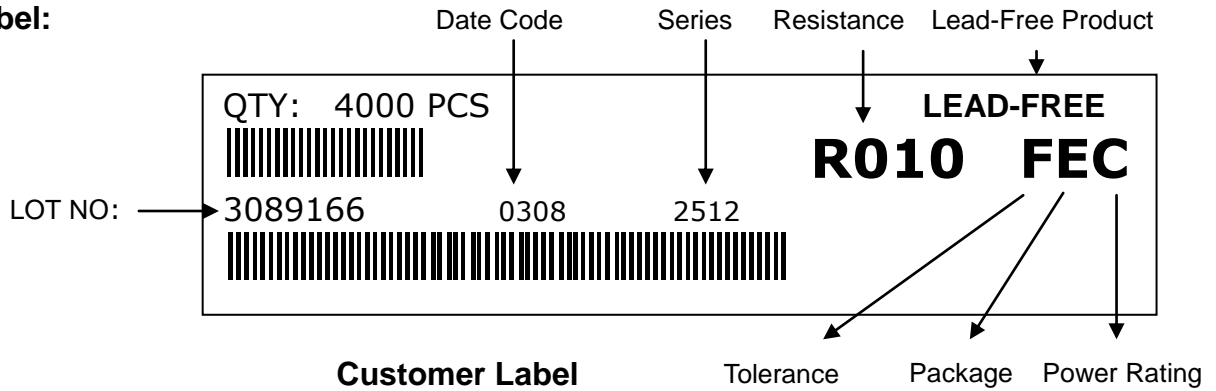

9. Taping



Packing	Type	A	B	W	F	E	P ₁	P ₂	P ₀	D ₀	T
Emboss	RLM25	3.6 ^{+0.2} _{-0.18}	6.9±0.2	12.±0.2	5.5±0.05	1.75±0.1	4.0±0.1	2.0±0.05	4.0±0.05	φ 1.5 (+0.1/-0)	0.85±0.15



Lead-Free Current Sensing Resistors
RLM Series
(Halogen-Free)

Document No	TRLM-250S147D
Issued date	2013/07/02
Page	5/6

10. Reel Specification

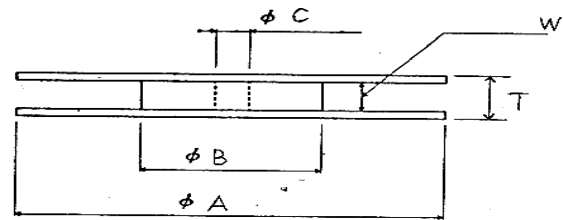

Series	ϕA	ϕB	ϕC	W	T
RLM 25	180 ⁺⁰ ₋₃	60 ±1.0	13.0±1.0	13.0±1.0	15.4±2.0

11. Peeling Strength of Top Cover Tape

Test Condition: 0.1 to 0.7 N at a peel-off speed of 300 mm / min.

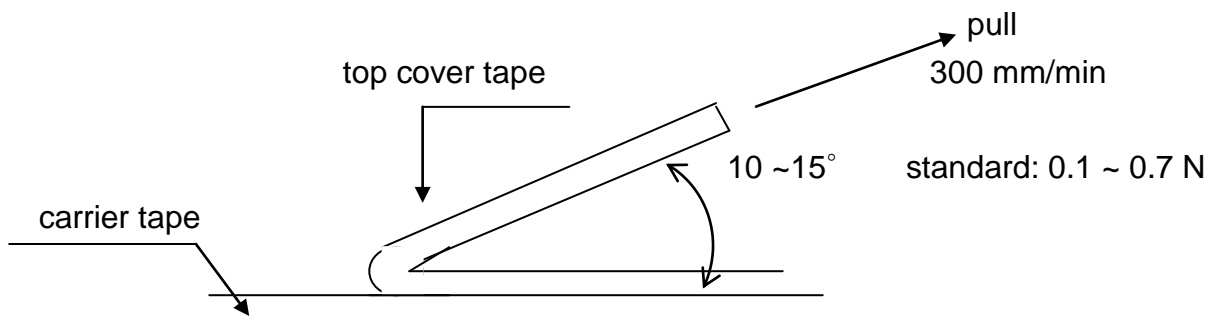

12. Storage Conditions:

Temperature: 5°C ~35°C, Humidity: 40%~75%

13. Shelf Life:

2 years from manufacturing date.



Lead-Free Current Sensing Resistors
RLM Series
(Halogen-Free)

Document No	TRLM-250S147D
Issued date	2013/07/02
Page	6/6

14. Recommend IR – Reflow profile : (solder : Sn96.5 / Ag3 / Cu0.5)

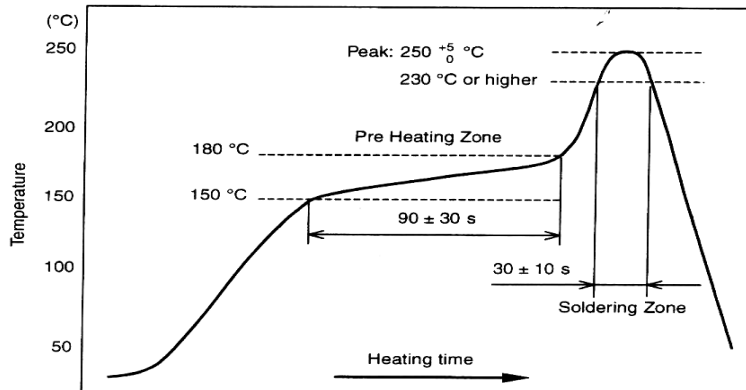

Peak : 260 $\begin{matrix} +5 \\ -0 \end{matrix}$ °C , 5 sec

Pre – heat Zone : 150 to 180 °C, 90±30 sec

Soldering Zone : 230°C or higher , 30±10 sec

Iron Solder: 350±10°C , 3+1/-0 sec

15. ECN

Engineering Change Notice: The customer will be informed with ECN if there is significant modification on the characteristics and materials described in Approval Sheet.