

# KUKDONG Electronic Precision Co., Ltd.

## MIL-DTL-5015 SERIES CONNECTOR



[www.kdep.co.kr](http://www.kdep.co.kr)

KD connectors are designed, manufactured and tested to MIL-DTL-5015, the military detailed specification. The connectors used in wide ranges of both military and general industrial applications.

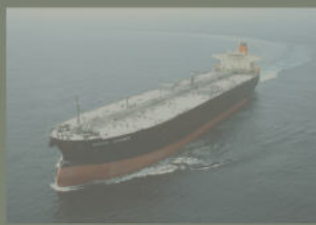

극동전자정밀주식회사

KUKDONG

KUKDONG Electronic Precision Co., Ltd.

# KD / MIL-DTL-5015 Series

---

## Contents

<b>Introduction</b>	<b>2</b>
<b>Connector Design</b>	<b>2</b>
<b>Technical Data</b>	<b>3</b>
<b>Matching Guide</b>	<b>5</b>
<b>Pin / Socket Inserts</b>	<b>5</b>
<b>How to Order</b>	<b>6</b>
<b>Connector Arrangements</b>	<b>7</b>
<b>Connector Dimensions</b>	<b>20</b>
KD3100	20
KD3102	21
KD3101	22
KD3106	24
KD3108	25
KD3103	27
KD25183	27
<b>Exploded View</b>	<b>28</b>
KD3102B	28
KD3106B	29
KD3108B	29
<b>Accessories</b>	<b>30</b>
<b>Components</b>	<b>34</b>

# KD / MIL-DTL-5015 Series

---

## Introduction

KD MIL-DTL-5015 series Connectors were designed for the connection of electric and electronic device and KD connectors are used in wide ranges of both military and general industrial applications. With advantages of high quality, intermatability, reliability and low price, KD5015 connectors are designed, manufactured and tested to MIL-DTL-5015, the Military Detailed Specification.

## Applications

- Railroad Equipment
- Industrial Machinery
- Engines
- Battery Systems
- Motion Control
- Power Generators
- Mobile Equipments
- Earth Moving Equipment

## Connector design

MIL-DTL-5015 series applies to the circular threaded electrical solder-contact connectors. Shell is made through aluminum alloy diecasting with zinc plating and olive drab chromate finish protecting the shell against environmental influences. These connectors operate in temperatures of  $-55^{\circ}\text{C}$  to  $+125^{\circ}\text{C}$  ( $-67^{\circ}\text{F}$  to  $+257^{\circ}\text{F}$ ) under the harshest possible conditions.

The various classes and types of KD connectors are intended for application as follows.

- a. KD3100 : Receptacle intended for wall or bulkhead mounting and for use with conduit or cable clamp.
- b. KD3101 : Plug intended for use at the end of a cable where mounting provisions are not required.
- c. KD3102 : Receptacle intended for mounting on shielding boxes and equipment cases. They have no fittings and are for use with open wiring. They are nonenvironmental and are intended for use on boxes where environmental seal is achieved by some other means.
- d. KD3106 : Plug intended for use at the end of a cable to be mated with a receptacle.
- e. KD3108 :  $90^{\circ}$  plug intended for use at the end of a cable where space does not permit the use of a straight plug.
- f. KD25183 : Plug intended for use in applications where a potted seal around wires is required.
- g. Class A connectors are solid shell connectors intended for nonenvironmental applications.
- h. Class B connectors have split shell connectors intended for nonenvironmental applications. The split shell provides greater accessibility to solder connections, as may be needed if the cable is contained in conduit.
- i. If air leakage requirements are critical, a resilient insert receptable should be used or the connector should be potted.

# KD / MIL-DTL-5015 Series

## Technical Data

### Electrical Data Contact rating

(Assembled in insulator)

Contact size	Current [A]
16	13
12	23
8	46
4	80
0	150

### Insulation resistance

The insulation resistance to be tested per EIA364.21 and MIL-DTL-5015 3.18 test condition B; DC500V/5000M $\Omega$  min

### Operating & Test voltage

The dielectric withstanding voltage to be tested per EIA364.20 and MIL-DTL-5015 3.11

Service rating	Test Voltage AC(rms)		Operating Voltage	
	sea level	70,000ft	DC	AC(rms)
Inst	1000	260	250	200
A	2000	360	700	500
D	2800	400	1250	900
E	3500	440	1750	1250
B	4500	480	2450	1750
C	7000	560	4200	3000

### Contact resistance

Voltage drops to be tested with the coupling ring removed per EIA364.06 and MIL-DTL-5015 3.15

Contact size	Test current [A]	Potential drop max.mV	Contact resistance max.m $\Omega$
16	13	49	6
12	23	42	3
8	46	26	1
4	80	23	0.5
0	150	21	0.2

### Mechanical Features Ambient temperature

-55°C/+125°C

### Humidity

14-day 71°C $\pm$ 2°C to 95% $\pm$ 3% humidity testing per EIA364.31 Method II and MIL-DTL-5015 3.14

### Durability

Test mating / unmating 100 times at the speed of max 60 times / hour.  
Per EIA364.09 and MIL-DTL-5015 3.16

### Salt spray

Unmated connectors and contacts meet 48hour exposure per EIA364.26 test condition letter B and MIL-DTL-5015 3.17

### Sine vibration

10 $\mu$ s max at 10 to 500Hz(15g) discontinuity per EIA364.28 test condition II and MIL-DTL-5015 3.12.1

### Shock

50g's/11ms duration, three major axes 10 $\mu$ s max discontinuity per EIA364.27 test condition A and MIL-DTL-5015 3.13

### Contact retention

The contact retention to be tested per EIA364.29 and MIL-DTL-5015 3.10

Contact size	Test force N (lbs)
16	44.5 (10)
12	66.7 (15)
8	89.0 (20)
4	89.0 (20)
0	111.2 (25)

# KD / MIL-DTL-5015 Series

## Contact engagement and separation forces

The Contact engagement and separation forces to be tested per EIA364.37 and MIL-DTL 5015 3.25

Contact mating end size	Contact engagement and separation force		
	Min N (lbs)	Average N (lbs)	MAX N (lbs)
16	0.6 (0.13)	2.06(0.46)	13.3 (3)
12	0.8 (0.18)	3.50(0.79)	22.2 (5)
8	1.4 (0.31)	-	44.5 (10)
4	2.8 (0.63)	-	66.7 (15)
0	4.2 (0.94)	-	89.0 (20)

## Contact size

Contact size	Pin O.D [mm]	Solder pot [mm]
16	1.6	2.0
12	2.4	3.0
8	3.6	5.4
4	5.7	8.5
0	9.1	12.0

## Wire sealing range

Contact size	Wire range accommodations			
	Insulation O.D limit	Wire size	Metric [mm <sup>2</sup> ]	Conductor [mm]
16	1.6~3.3	16~20	1.3max	1.25~1.7
12	2.9~4.3	12~14	3.5max	1.95~2.4
8	4.2~6.5	8~10	8.0max	4.3~4.8
4	6.9~9.4	4~6	22.0max	5.2~6.0
0	10.5~14.0	0~2	50.0max	9.6~10.7

## Materials

### Shell

Material	Aluminum alloy Die Castings & Aluminum alloy
Finish	Olive drab chromate coating over zinc plating
Alternative finish	Black coating over zinc plating(RoHS) Electroless nickel

### Insulator and grommet

Insulator	Synthetic rubber & polychloroprene Synthetic plastic
Grommet	Synthetic rubber & polychloroprene

### Contact

Material	Copper alloy
Finish	Silver plating Gold plating

# KD / MIL-DTL-5015 Series

## Matching Guide

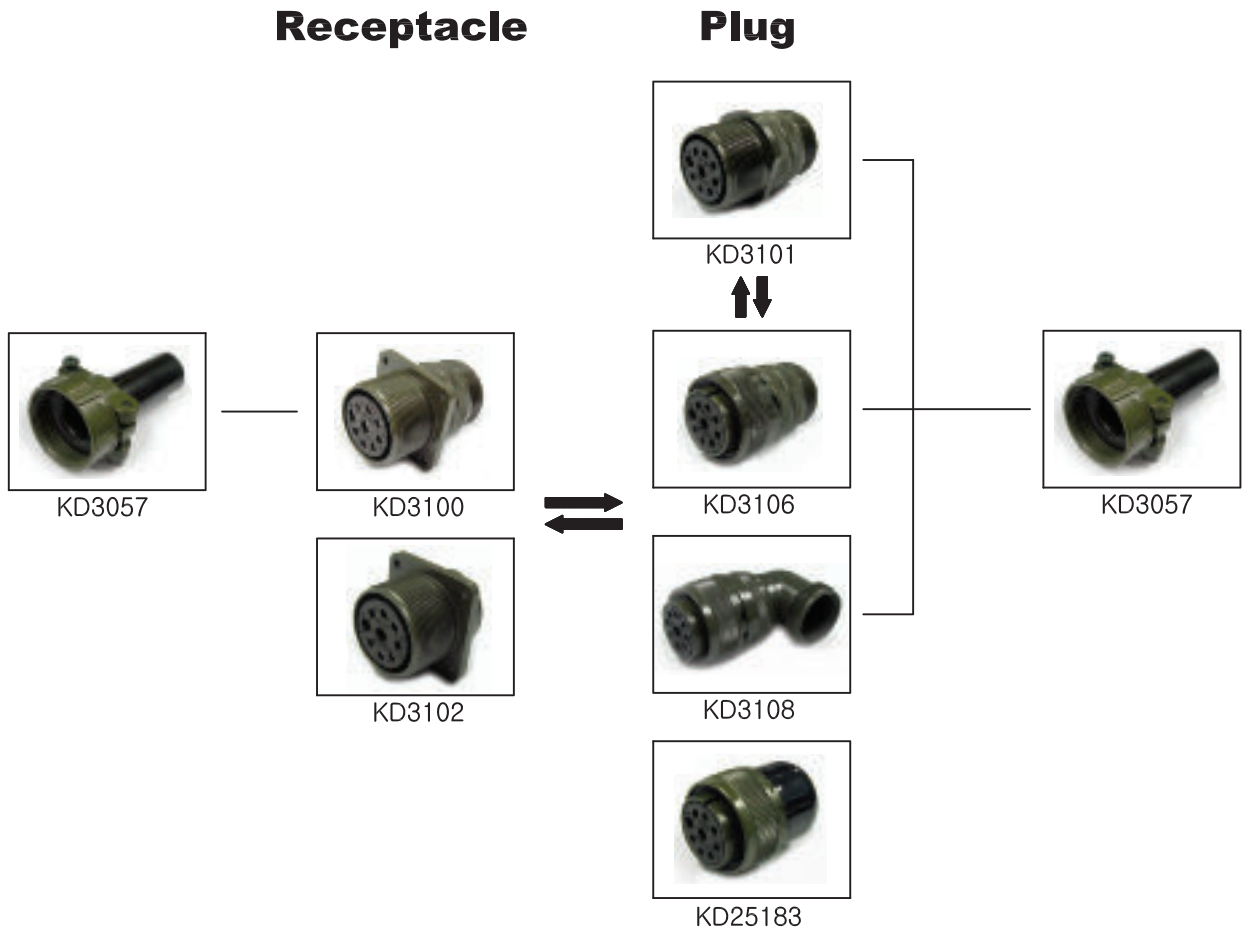

## Pin or Socket Inserts

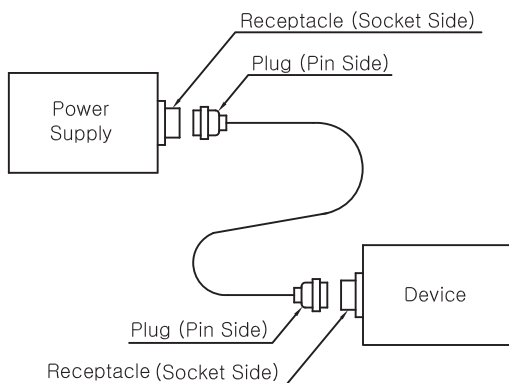

Connector combinations are formed with plugs and receptacles that are connected with pin and socket contacts.

Either the receptacle or the plug can be provided with pin inserts or socket inserts.

However, if one side is a pin insert, the mating side should be a socket insert.

The type to use will be determined by the state of the equipment but it is generally recommended to use the socket on the output side of the equipment and pin on the input side.

# KD / MIL-DTL-5015 Series

## How to order

### KD Order Reference

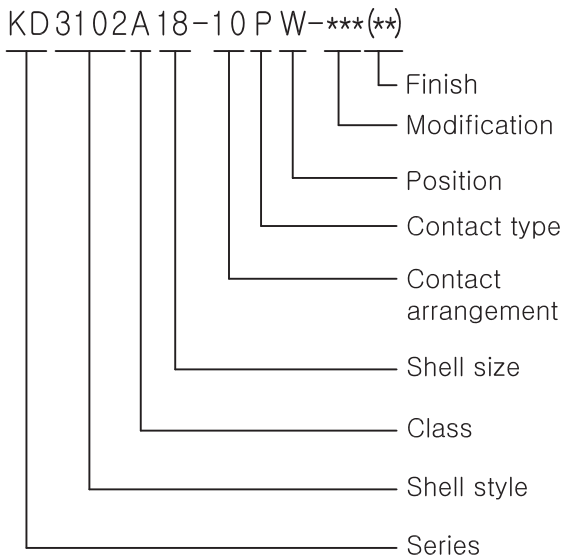

### MS Order Reference

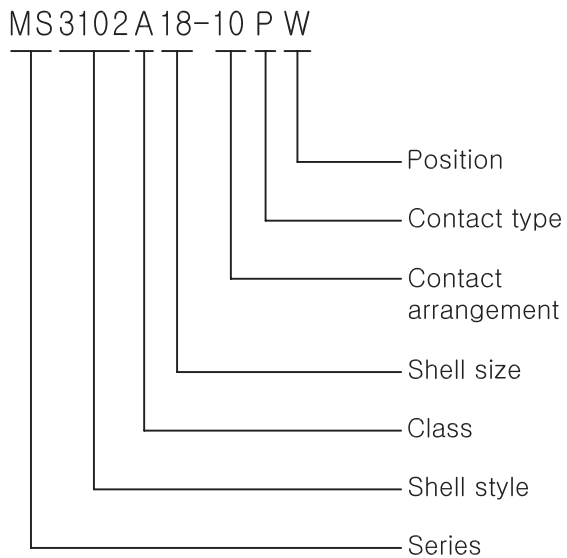

### Series

- KD Kukdong circular connectors with threaded coupling
- MS Military Standard to latest MIL-DTL-5015 revision

### Shell style

- 3100 Wall mounting receptacle
- 3101 Cable connecting plug
- 3102 Box mounting receptacle
- 3106 Straight plug
- 3108 90° plug
- 25183 Potting seal plug

### Class

- A Solid shell solder contact connectors.
- B Split shell solder contact connectors.
- E/F Environmental with resilient insulators and integral cable clamp.
- P Environment resistant potted solder contact connectors.
- R Environmental with resilient insulators and shortened lightweight endbell.

### Shell size

- 10SL, 12s, 12, 14s, 16s, 16, 18
- 20, 22, 24, 28, 32, 36, 40

### Contact arrangement

See page 7~19

### Contact type

- P - Pin contact
- S - Socket contact

### Position

Alternate insert position(W,X,Y or Z)  
Leave Blank for Normal position  
See page 7~9

### Modification

- No code Threaded Coupling Nut (with Solder contacts)
- B Bayonet Coupling Nut (with Solder contacts)
- F80 Threaded Coupling Nut (with Crimp AWG contacts)
- B-F80 Bayonet Coupling Nut (with Crimp AWG contacts)

### Finish

- No code Olive drab over zinc plating (standard)
- D1 Electro-deposition coating, olive drab (RoHS)
- D2 Electro-deposition coating, black (RoHS)
- B4 Cadmium chromate over zinc plating
- R Electroless nickel plating
- N Nickel plating
- Z2 Black over zinc plating
- Z21 Black trivalent chromate over zinc plating (RoHS)
- Z3 iridescent yellow over zinc plating

# KD / MIL-DTL-5015 Serie

## Contact Arrangements [ For Class A, E/F, P, R ]

### Alternate Insert Positions

※ View shows pin front side or socket rear side

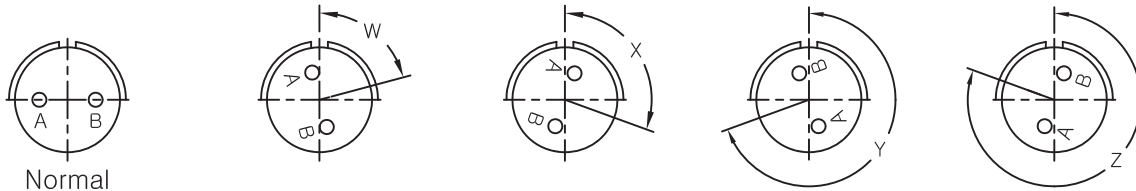

Shell Size	Insert Number	Contacts							Alternate pos.			
		Tot	20	16	12	8	4	0	W	X	Y	Z
10SL	10SL-3	3		3								
	10SL-4	2		2								
12s	12s-3	2		2				70	145	215	290	
	12s-4	1		1								
	12SA10	4		4								
12	12-5	1			1							
14s	14s-1	3		3								
	14s-2	4		4					120	240		
	14s-4	1		1								
	14s-5	5		5						110		
	14s-6	6		6								
	14s-7	3		3				90	180	270		
	14s-9	2		2				70	145	215	290	
	14SA7	7		7								
	14SA10	10	10									
14	14-3	1				1						
16s	16s-1	7		7				80			280	
	16s-4	2		2				35	110	250	325	
	16s-5	3		3				70	145	215	290	
	16s-8	5		5					170	265		
	16s-01	8	8									
16	16-9	4		2	2			35	110	250	325	
	16-10	3			3			90	180	270		
	16-11	2			2			35	110	250	325	
18	18-1	10		10				70	145	215	290	
	18-3	2			2			35	110	250	325	
	18-4	4		4				35	110	250	325	
	18-5	3		1	2			80	110	250	280	
	18-8	8		7	1			70			290	
18-9	7		5	2			80	110	250	280		

Shell Size	Insert Number	Contacts							Alternate pos.			
		Tot	20	16	12	8	4	0	W	X	Y	Z
18	18-10	4			4					120	240	
	18-11	5			5					170	265	
	18-12	6		6				80			280	
	18-19	10		10					120	240		
	18-20	5		5				90	180	270		
	18-21	3			3							
	18-22	3		3					70	145	215	290
20	20-2	1						1				
	20-3	3			3			70	145	215	290	
	20-4	4			4			45	110	250		
	20-7	8		8				80	110	250	280	
	20-11	13		13								
	20-15	7			7			80			280	
	20-16	9		7	2			80	110	250	280	
	20-17	6		1	5			90	180	270		
	20-18	9		6	3			35	110	250	325	
	20-19	3				3		90	180	270		
	20-22	6		3		3		80	110	250	280	
	20-23	2					2	35	110	250	325	
	20-24	4		2		2		35	110	250	325	
	20-27	14		14				35	110	250	325	
	20-29	17		17				80			280	
20-33	11		11									
20-01	10		10									
20A24	24	24										
20A48	19		19						80	280		
22	22-1	2				2		35	110	250	325	
	22-2	3				3		70	145	215	290	
	22-5	6		4	2			35	110	250	325	
	22-7	1									1	



# KD / MIL-DTL-5015 Series

## Contact Arrangements [ For Class A, E/F, P, R ]

### Alternate Insert Positions

※ View shows pin front side or socket rear side

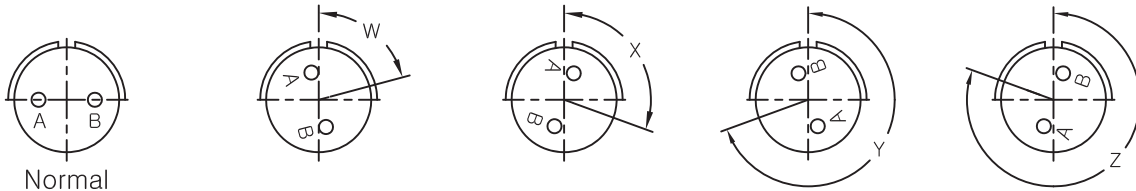

Shell Size	Insert Number	Contacts						Alternate pos.				
		Tot	20	16	12	8	4	0	W	X	Y	Z
22	22-8	2			2				35	110	250	325
	22-9	3			3				70	145	215	290
	22-10	4		4					35	110	250	325
	22-14	19		19					80	110	250	280
	22-19	14		14					80	110	250	280
	22-22	4					4			110	250	
	22-23	8			8				35		250	
24	24-2	7			7				80			280
	24-5	16		16					80	110	250	280
	24-7	16		14	2				80	110	250	280
	24-9	2					2		35	110	250	325
	24-10	7				7			80			280
	24-11	9			6	3			35	110	250	325
	24-12	5			3		2		80	110	250	280
	24-20	11		9	2				80	110	250	280
	24-21	10		9		1			80	110	250	280
	24-22	4				4			45	110	250	
	24-28	24		24					80	110	250	280
	24-67	19			19				80			335
	24B24	12			12							
	28	28-2	14		12	2				35	110	250
28-3		3				3			70	145	215	290
28-5		5		2	1		2		35	110	250	325
28-6		3					3		70	145	215	290
28-9		12		6	6				80	110	250	280
28-10		7			3	2	2		80	110	250	280
28-11		22		18	4				80	110	250	280
28-12		26		26					90	180	270	
28-15		35		35					80	110	250	280
28-16		20		20					80	110	250	280

Shell Size	Insert Number	Contacts						Alternate pos.					
		Tot	20	16	12	8	4	0	W	X	Y	Z	
28	28-17	15		15					80	110	250	280	
	28-19	10		6	4				80	110	250	280	
	28-20	14		4	10				80	110	250	280	
	28-21	37		37					80	110	250	280	
	28-22	6		3			3		70	145	215	290	
	28-51	12			12				80	135	195		
	28-72	72	72						72	144	216	288	
	28A16	9		5			4						
32	32-1	5			3			2	80	110	250	280	
	32-3	9		4	2		2	1	80	110	250	280	
	32-5	2						2	35	110	250	325	
	32-6	23		16	2	3	2		80	110	250	280	
	32-7	35		28	7				80	125	235	280	
	32-8	30		24	6				80	125	235	280	
	32-15	8			6			2	35	110	250	280	
	32-17	4						4	45	110	250		
	32-59	42		40		2							
	32-63	5						5					
	32-101	101	101						30	142			
	32A10	54		54									
	36	36-1	22		18	4				80	110	250	280
		36-3	6			3			3	70	145	215	290
36-4		3						3	70	145	215	290	
36-5		4						4		120	240		
36-8		47		46	1				80	110	250	280	
36-9		31		14	14	2	1		80	125	235	280	
36-10		48		48					80	125	235	280	
36-77		7						7					
36-78		14		2		12			35	106	254	325	
40	40-56	85		85					72	144	216	288	

# KD / MIL-DTL-5015 Series

## Contact Arrangements [ For Class B ]

### Alternate Insert Positions

※ View shows pin front side or socket rear side

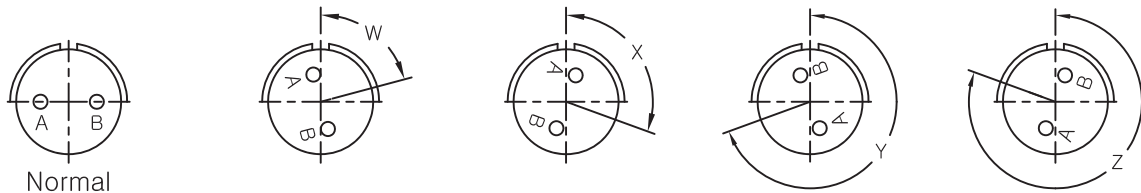

Shell Size	Insert Number	Contacts							Alternate pos.			
		Tot	20	16	12	8	4	0	W	X	Y	Z
14s	14s-2	4	4						120	240		
	14s-5	5	5						110			
	14s-6	6	6									
16	16-10	3		3				90	180	270		
18	18-1	10	10					70	145	215	290	
	18-8	8	7	1				70			290	
	18-10	4		4				120	240			
	18-12	6	6					80			280	
	18-19	10	10					120	240			
20	20-4	4		4				45	110	250		
	20-7	8	8					80	110	250	280	
	20-15	7		7				80			280	
	20-16	9	7	2				80	110	250	280	
	20-18	9	6	3				35	110	250	325	
	20-27	14	14					35	110	250	325	
	20-29	17	17					80			280	

Shell Size	Insert Number	Contacts							Alternate pos.			
		Tot	20	16	12	8	4	0	W	X	Y	Z
22	22-14	19		19					80	110	250	280
	22-19	14		14					80	110	250	280
	22-22	4				4			110	250		
	22-23	8			8				35		250	
24	24-2	7			7				80			280
	24-5	16		16					80	110	250	280
	24-10	7				7			80			280
	24-11	9			6	3			35	110	250	325
	24-28	24		24					80	110	250	280
28	28-2	14		12	2				35	110	250	325
	28-11	22		18	4				80	110	250	280
	28-15	35		35					80	110	250	280
	28-16	20		20					80	110	250	280
	28-20	14		4	10				80	110	250	280
	28-21	37		37					80	110	250	280
32	32-7	35		28	7				80	125	235	280
	32-17	4				4			45	110	250	
	32-22	54		54								
36	36-10	48		48					80	125	235	280

**NOTE : class B of Split type**

KD3102B 18-10 PW

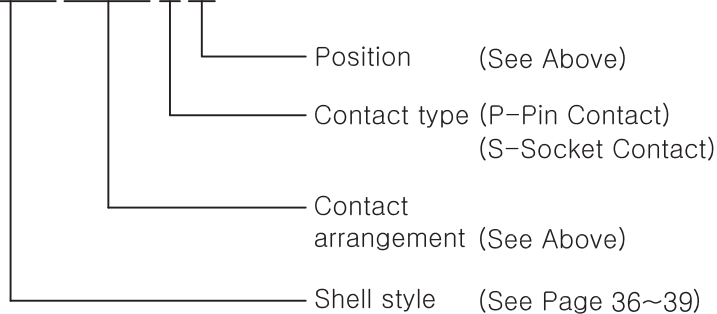

# KD / MIL-DTL-5015 Series

## Contact Arrangements

### Contact Size



### 1 CONTACT



Insert number	12S-4	12-5	14-3	14S-4
No. of contacts	1	1	1	1
Contact size	16	12	8	16
Service rating	D	D	A	D



Insert number	16-12	20-2	22-7
No. of contacts	1	1	1
Contact size	4	0	0
Service rating	A	D	E

### 2 CONTACT



Insert number	10SL-4	12S-3	14S-9	16S-4
No. of contacts	2	2	2	2
Contact size	16	16	16	16
Service rating	A	A	A	D

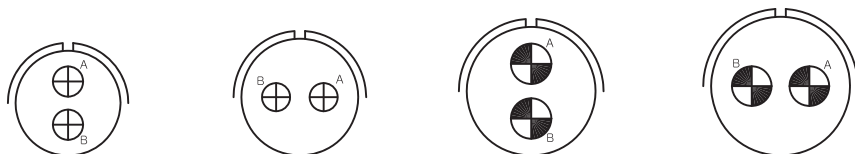

Insert number	16-11	18-3	20-23	22-1
No. of contacts	2	2	2	2
Contact size	12	12	8	8
Service rating	A	D	A	D

# KD / MIL-DTL-5015 Series

## Contact Size

20 ○ 16 ● 12 ⊕ 8 ⊕ 4 ⊕ 0 ⊕

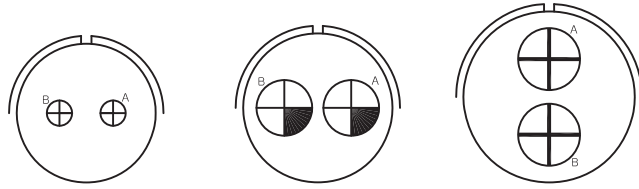

Insert number	22-8	24-9	32-5
No. of contacts	2	2	2
Contact size	12	4	0
Service rating	E	A	D

## 3 CONTACT



Insert number	10SL-3	14S-1	16S-5	16-10
No. of contacts	3	3	3	3
Contact size	16	16	16	12
Service rating	A	A	A	A



Insert number	18-21	18-22	20-3	20-19
No. of contacts	3	3	3	3
Contact size	12	16	12	8
Service rating	A	D	D	A

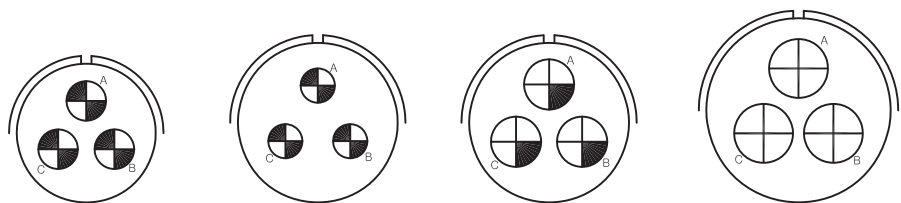

Insert number	22-2	28-3	28-6	36-4
No. of contacts	3	3	3	3
Contact size	8	8	4	0
Service rating	D	E	D	D(A) A(B,C)

# KD / MIL-DTL-5015 Serise

## Contact Size

20 ○ 16 ● 12 ⊕ 8 ⊗ 4 ⊕ 0 ⊕

### 4 CONTACT

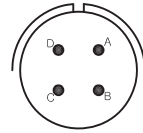
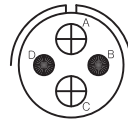
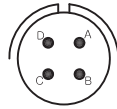
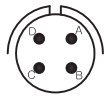

Insert number	12SA10	14S-2	16-9	18-4
No. of contacts	4	4	4	4
Contact size	16	16	2-16, 2-12	16
Service rating	INST	INST	A	D

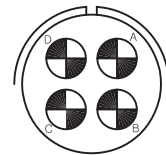
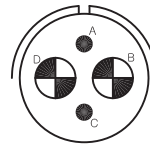
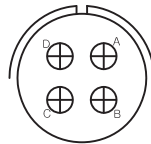
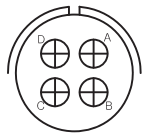

Insert number	18-10	20-4	20-24	22-22
No. of contacts	4	4	4	4
Contact size	12	12	2-16, 2-8	8
Service rating	A	D	A	A

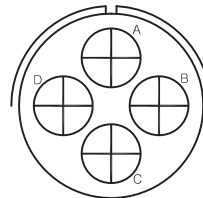
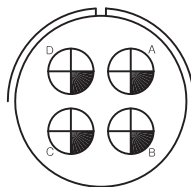
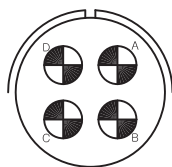

Insert number	24-22	32-17	36-5
No. of contacts	4	4	4
Contact size	8	4	0
Service rating	D	D	A

### 5 CONTACT

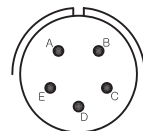
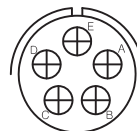
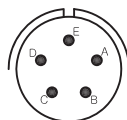
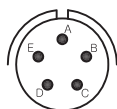

Insert number	14s-5	16s-8	18-11	18-20
No. of contacts	5	5	5	5
Contact size	16	16	12	16
Service rating	INST	A	A	A

# KD / MIL-DTL-5015 Series

## Contact Size

20 ○ 16 ● 12 ⊕ 8 ⊕ 4 ⊕ 0 ⊕

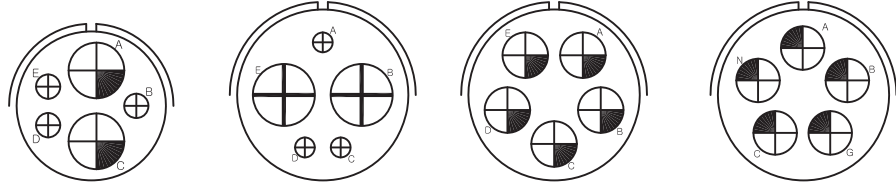

Insert number	24-12	32-1	32-63	32A5
No. of contacts	5	5	5	5
Contact size	3-12, 2-4	3-12, 2-0	4	4
Service rating	A	E(A) D(B,C,D,E)	D	D

## 6 CONTACT



Insert number	14S-6	18-12	20-8	20-17
No. of contacts	6	6	6	6
Contact size	16	16	4-16, 2-8	1-16, 5-12
Service rating	INST	A	INST	A

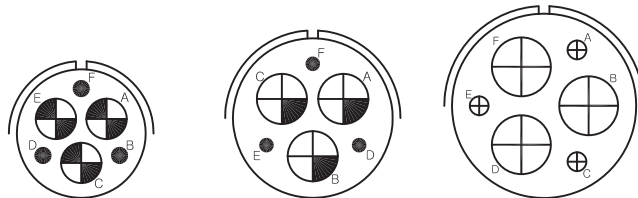

Insert number	20-22	28-22	36-3
No. of contacts	6	6	6
Contact size	3-16, 3-8	3-16, 3-4	12-3, 3-0
Service rating	A	D	D

## 7 CONTACT



Insert number	14SA7	16s-1	18-9	20-15
No. of contacts	7	7	7	7
Contact size	16	16	5-16, 2-12	12
Service rating	INST	A	INST	A

# KD / MIL-DTL-5015 Series

## Contact Size

20 ○ 16 ● 12 ⊕ 8 ⊗ 4 ⊕ 0 ⊕

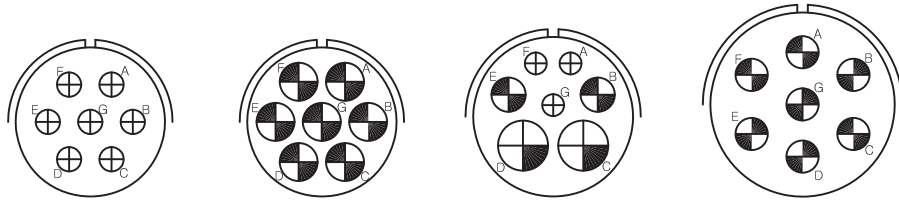

Insert number	24-2	24-10	28-10	36-77
No. of contacts	7	7	7	7
Contact size	12	8	3-12, 2-8, 2-4	4
Service rating	D	A	D(G) A(A,B,C,D,E,F)	D

## 8 CONTACT



Insert number	16s-01	18-8	20-7	22-18
No. of contacts	8	8	8	8
Contact size	16	7-16, 1-12	16	16
Service rating	A	A	D(A,B,G,H) A(All others)	D(All others) A(C,D,E)

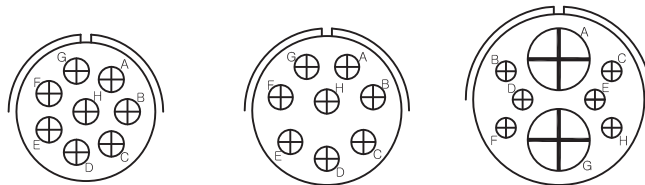

Insert number	22-23	24-6	32-15
No. of contacts	8	8	8
Contact size	12	12	6-12, 2-0
Service rating	D(H) A(All others)	D(A,G,H) A(All others)	D

## 9 CONTACT

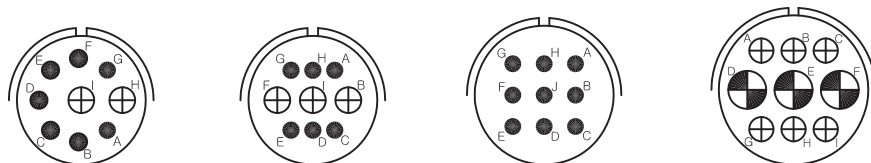

Insert number	20-16	20-18	22-20	24-11
No. of contacts	9	9	9	9
Contact size	7-16, 2-12	6-16, 3-12	16	6-12, 3-8
Service rating	A	A	A	A

# KD / MIL-DTL-5015 Series

## Contact Size

20 ○ 16 ● 12 ⊕ 8 ⊕ 4 ⊕ 0 ⊕

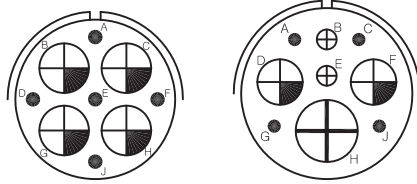

Insert number	28A16	32-3
No. of contacts	9	9
Contact size	5-16, 4-4	4-16, 2-12, 2-4, 1-0
Service rating	A(E) INST(All others)	D

## 10 CONTACT

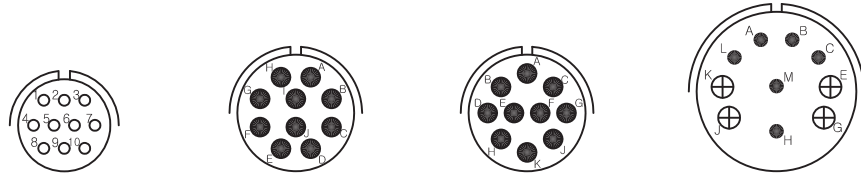

Insert number	14SA10	18-1	18-19	28-19
No. of contacts	10	10	10	10
Contact size	20	16	16	6-16, 4-12
Service rating	INST	A(B,C,F,G) INST(All others)	A	D(A,B) B(H,M) A(All others)

## 11 CONTACT

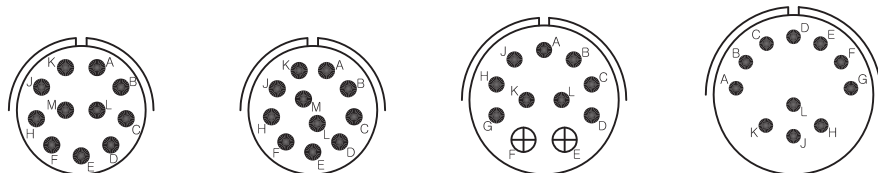

Insert number	20-31	20-33	24-20	28-14
No. of contacts	11	11	11	6
Contact size	16	16	9-16, 2-12	16
Service rating	A	A	D	D

## 12 CONTACT

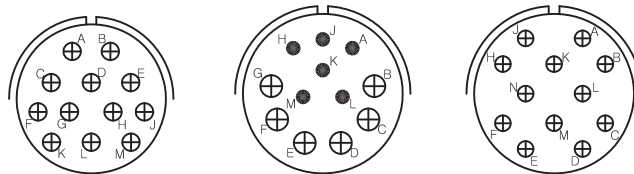

Insert number	24B24	28-9	28-51
No. of contacts	12	12	12
Contact size	12	6-16, 6-12	12
Service rating	A	D	D



# KD / MIL-DTL-5015 Series

## Contact Size

20 ○ 16 ● 12 ⊕ 8 ⊗ 4 ⊕ 0 ⊕

### 13 CONTACT

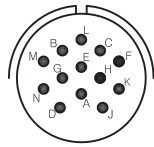

Insert number	20-11	20-27	22-19
No. of contacts	13	14	14
Contact size	16	16	16
Service rating	INST	A	A

### 14 CONTACT

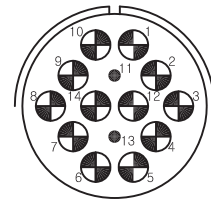
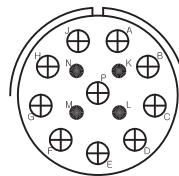
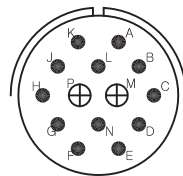
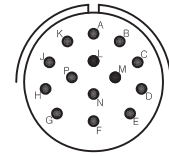
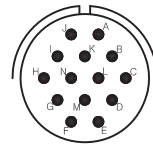

Insert number	28-2	28-20	36-78
No. of contacts	14	14	14
Contact size	12-16, 2-12	4-16, 10-12	2-16, 12-8
Service rating	D	A	D

### 15 CONTACT

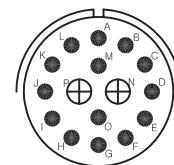
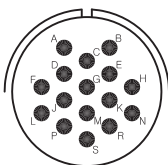
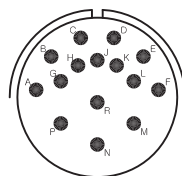

Insert number	28-17	24-5	24-7
No. of contacts	15	16	16
Contact size	16	16	14-16, 2-12
Service rating	B(R) D(M,N,P) A(All others)	A	A

# KD / MIL-DTL-5015 Series

## Contact Size

20 ○ 16 ● 12 ⊕ 8 ⊕ 4 ⊕ 0 ⊕

### 17 CONTACT

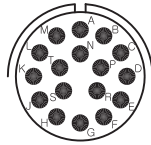

Insert number	20-29	22-14	28-16
No. of contacts	17	19	20
Contact size	16	16	16
Service rating	A	A	A

### 19 CONTACT

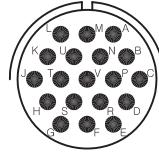

### 20 CONTACT

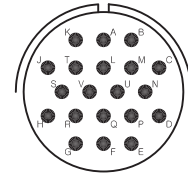

### 22 CONTACT

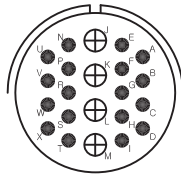

Insert number	28-11	36-1	32-6
No. of contacts	22	22	23
Contact size	18-16, 4-12	18-16, 4-12	16-16, 2-12, 3-8, 2-4
Service rating	A	D	A

### 23 CONTACT

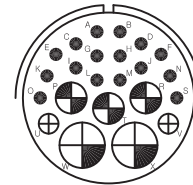
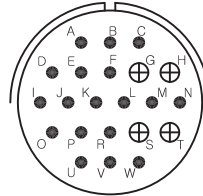

### 24 CONTACT

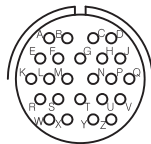

Insert number	20A24	24-28	28-12
No. of contacts	24	24	26
Contact size	20	16	16
Service rating	INST	INST	A

### 26 CONTACT

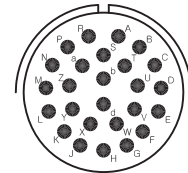
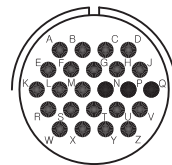

# KD / MIL-DTL-5015 Series

## Contact Size

20 ○ 16 ● 12 ⊕ 8 ⊕ 4 ⊕ 0 ⊕

### 28 CONTACT

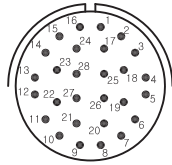

Insert number	24A28	32-8	36-9
No. of contacts	28	30	31
Contact size	16	24-16, 6-12	14-16, 14-12, 2-8, 1-4
Service rating	INST	A	A

### 30 CONTACT

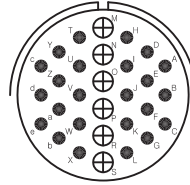

### 31 CONTACT

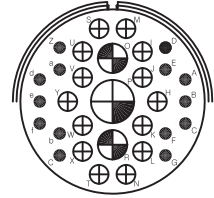

### 35 CONTACT

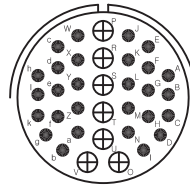
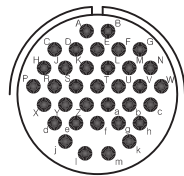

### 37 CONTACT

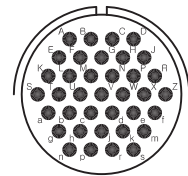

Insert number	28-15	32-7	28-21
No. of contacts	35	35	37
Contact size	16	28-16, 7-12	16
Service rating	A	A(all others) INST(A,B,h,j)	A

### 43 CONTACT

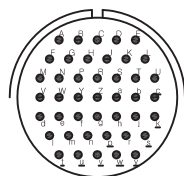

### 46 CONTACT

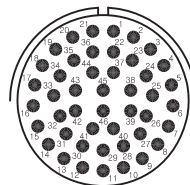

### 47 CONTACT

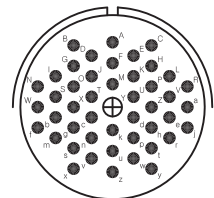

Insert number	28A51	32-73	36-8
No. of contacts	43	46	47
Contact size	16	16	46-16, 1-12
Service rating	A	A	A

# KD / MIL-DTL-5015 Series

## Contact Size

20 ○ 16 ● 12 ⊕ 8 ⊕ 4 ⊕ 0 ⊕

### 48 CONTACT

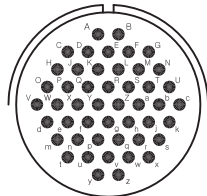

### 52 CONTACT

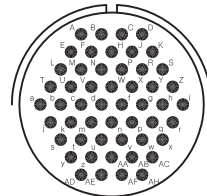

Insert number	36-10	36-52
No. of contacts	48	52
Contact size	16	16
Service rating	A	A

### 54 CONTACT

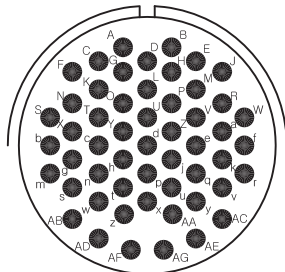

### 72 CONTACT

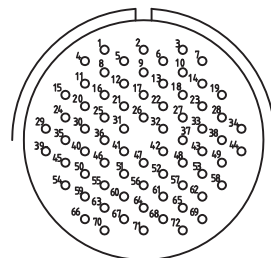

Insert number	32A10 & 32-22	28-72
No. of contacts	54	72
Contact size	16	20
Service rating	A	INST

### 85 CONTACT

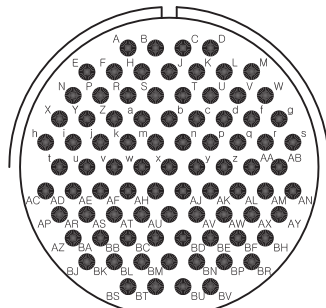

### 101 CONTACT

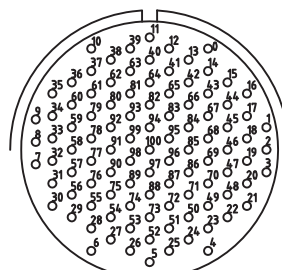

Insert number	40-56	32-101
No. of contacts	16	101
Contact size	85	20
Service rating	A	INST

# KD / MIL-DTL-5015 Series

## Connector Dimensions

KD3100 Class A  
MS3100 Class A  
Wall mounting receptacle

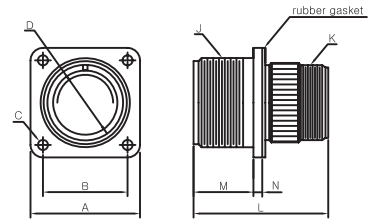

Shell size	□A	□B	∅C	∅D	J	K	L	M	N	
	±0.79	±0.13	+0.25 -0.13	+0.38	THD-2A	THD-2A	max	+0.79	max	min
10s / 10SL	25.40	18.26	3.05	11.38	5/8-24UNEF	5/8-24UNEF	38.89	14.27	3.96	1.57
12s	27.79	20.62	3.05	14.15	3/4-20UNEF	5/8-24UNEF	42.88	14.27	3.96	1.57
12	27.79	20.62	3.05	14.15	3/4-20UNEF	5/8-24UNEF	52.37	19.05	3.96	1.57
14s	30.18	23.01	3.05	17.32	7/8-20UNEF	3/4-20UNEF	42.88	14.27	3.96	1.57
14	30.18	23.01	3.05	17.32	7/8-20UNEF	3/4-20UNEF	52.37	19.05	3.96	1.57
16s	32.54	24.61	3.05	20.50	1 -20UNEF	7/8-20UNEF	42.88	14.27	3.96	1.57
16	32.54	24.61	3.05	20.50	1 -20UNEF	7/8-20UNEF	52.37	19.05	3.96	1.57
18	34.93	26.97	3.05	23.67	1 1/8-18UNEF	1 -20UNEF	52.37	19.05	5.16	2.39
20	38.10	29.36	3.05	26.87	1 1/4-18UNEF	1 3/16-18UNEF	55.58	19.05	5.16	2.39
22	41.28	31.75	3.05	30.02	1 3/8-18UNEF	1 3/16-18UNEF	55.58	19.05	5.16	2.39
24	44.45	34.93	3.73	33.20	1 1/2-18UNEF	1 7/16-18UNEF	58.72	20.62	5.16	2.39
28	50.80	39.67	3.73	38.76	1 3/4-18UNS	1 7/16-18UNEF	58.72	20.62	5.16	2.39
32	57.15	44.45	4.39	45.11	2 -18UNS	1 3/4-18UNS	61.93	22.23	9.12	3.18
36	63.50	49.23	4.39	50.67	2 1/4-16UN	2 -18UNS	61.93	22.23	9.12	3.18
40	69.85	55.58	4.39	57.02	2 1/2-16UN	2 1/4-16UN	61.93	22.23	9.12	3.18

KD3100 Class E, F  
MS3100 Class E, F  
Wall mounting receptacle  
with integral cable clamp  
(grommet included)

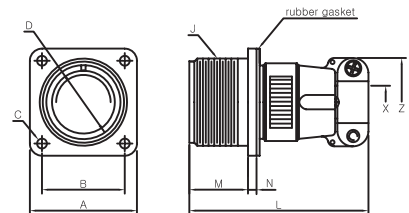

Used to carry wire thru walls  
or bulkheads or to provide  
a means of disconnection at a bulkhead

Shell size	□A	□B	∅C	∅D	J	L	M	N		X	Z
	±0.79	±0.13	+0.25 -0.13	+0.38	THD-2A	max	+0.79	max	min	min	±0.79
10s / 10SL	25.40	18.26	3.05	11.38	5/8-24UNEF	57.15	14.27	3.96	1.98	7.14	22.23
12s	27.79	20.62	3.05	14.15	3/4-20UNEF	57.15	14.27	3.96	1.98	7.14	22.23
12	27.79	20.62	3.05	14.15	3/4-20UNEF	66.68	19.05	3.96	1.98	7.14	22.23
14s	30.18	23.01	3.05	17.32	7/8-20UNEF	57.15	14.27	3.96	1.98	10.31	26.97
14	30.18	23.01	3.05	17.32	7/8-20UNEF	66.68	19.05	3.96	1.98	10.31	26.97
16s	32.54	24.61	3.05	20.50	1 -20UNEF	57.15	14.27	3.96	1.98	12.70	29.36
16	32.54	24.61	3.05	20.50	1 -20UNEF	66.68	19.05	3.96	1.98	12.70	29.36
18	34.93	26.97	3.05	23.67	1 1/8-18UNEF	68.28	19.05	5.16	2.39	13.49	31.75
20	38.10	29.36	3.05	26.87	1 1/4-18UNEF	69.85	19.05	5.16	2.39	16.66	37.31
22	41.28	31.75	3.05	30.02	1 3/8-18UNEF	69.85	19.05	5.16	2.39	19.05	37.31
24	44.45	34.93	3.73	33.20	1 1/2-18UNEF	75.41	20.62	5.16	2.39	19.84	42.88
28	50.80	39.67	3.73	38.76	1 3/4-18UNS	76.99	20.62	5.16	2.39	23.42	42.88
32	57.15	44.45	4.39	45.11	2 -18UNS	76.99	22.23	9.12	3.18	29.36	51.59
36	63.50	49.23	4.39	50.67	2 1/4-16UN	83.34	22.23	9.12	3.18	31.75	57.94

# KD / MIL-DTL-5015 Series

## Connector Dimensions

KD3100 Class R  
MS3100 Class R  
Wall mounting receptacle  
(grommet included)

R type has a shorter and  
lightweight endbell than E, F type

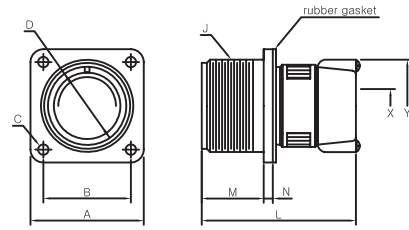

Shell size	□A	□B	φC	φD	J	L	M	N		X	Y
	±0.79	±0.13	+0.25 -0.13	+0.38	THD-2A	max	+0.79	max	min	min	±0.25
10s/10SL	25.40	18.26	3.05	11.38	5/8-24UNEF	46.69	14.27	3.96	1.98	7.14	23.83
12s	27.79	20.62	3.05	14.15	3/4-20UNEF	46.69	14.27	3.96	1.98	7.14	23.83
12	27.79	20.62	3.05	14.15	3/4-20UNEF	55.40	19.05	3.96	1.98	7.14	23.83
14s	30.18	23.01	3.05	17.32	7/8-20UNEF	46.69	14.27	3.96	1.98	10.31	28.58
14	30.18	23.01	3.05	17.32	7/8-20UNEF	55.40	19.05	3.96	1.98	10.31	28.58
16s	32.54	24.61	3.05	20.50	1 -20UNEF	46.69	14.27	3.96	1.98	12.70	30.96
16	32.54	24.61	3.05	20.50	1 -20UNEF	55.40	19.05	3.96	1.98	12.70	30.96
18	34.93	26.97	3.05	23.67	1 1/8-18UNEF	57.94	19.05	5.16	2.39	13.49	35.71
20	38.10	29.36	3.05	26.87	1 1/4-18UNEF	57.94	19.05	5.16	2.39	16.66	38.10
22	41.28	31.75	3.05	30.02	1 3/8-18UNEF	57.94	19.05	5.16	2.39	19.05	39.67
24	44.45	34.93	3.73	33.20	1 1/2-18UNEF	57.94	20.62	5.16	2.39	19.84	46.84
28	50.80	39.67	3.73	38.76	1 3/4-18UNS	57.94	20.62	5.16	2.39	23.42	46.84
32	57.15	44.45	4.39	45.11	2 -18UNS	58.98	22.23	9.12	3.18	29.36	53.98
36	63.50	49.23	4.39	50.67	2 1/4-16UN	58.98	22.23	9.12	3.18	31.75	58.72

KD3102 Class A  
MS3102 Class A  
Box mounting receptacle

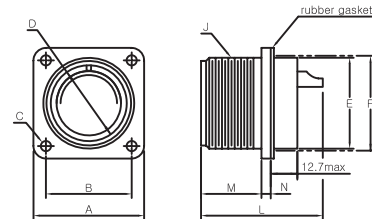

Shell size	□A	□B	φC	φD	φE	φF	J	L	M	N	
	±0.79	±0.13	+0.25 -0.13	+0.38	-4.78	Mounting Hole max	THD-2A	max	+0.79	max	min
10s/10SL	25.40	18.26	3.05	11.38	19.86	20.62	5/8-24UNEF	30.25	14.27	3.96	1.98
12s	27.79	20.62	3.05	14.15	19.86	20.62	3/4-20UNEF	30.25	14.27	3.96	1.98
12	27.79	20.62	3.05	14.15	19.86	20.62	3/4-20UNEF	43.51	19.05	3.96	1.98
14s	30.18	23.01	3.05	17.32	23.01	23.83	7/8-20UNEF	30.25	14.27	3.96	1.98
14	30.18	23.01	3.05	17.32	23.01	23.83	7/8-20UNEF	43.51	19.05	3.96	1.98
16s	32.54	24.61	3.05	20.50	26.21	26.97	1 -20UNEF	30.25	14.27	3.96	1.98
16	32.54	24.61	3.05	20.50	26.21	26.97	1 -20UNEF	44.45	19.05	3.96	1.98
18	34.93	26.97	3.05	23.67	29.36	30.18	1 1/8-18UNEF	49.23	19.05	5.16	2.39
20	38.10	29.36	3.05	26.87	32.56	33.32	1 1/4-18UNEF	49.23	19.05	5.16	2.39
22	41.28	31.75	3.05	30.02	35.71	36.53	1 3/8-18UNEF	49.23	19.05	5.16	2.39
24	44.45	34.93	3.73	33.20	38.91	39.97	1 1/2-18UNEF	49.23	20.62	5.16	2.39
28	50.80	39.67	3.73	38.76	45.26	46.02	1 3/4-18UNS	49.23	20.62	5.16	2.39
32	57.15	44.45	4.39	45.11	51.61	52.37	2 -18UNS	49.23	22.23	9.12	3.18
36	63.50	49.23	4.39	50.67	57.96	58.72	2 1/4-16UN	49.23	22.23	9.12	3.18
40	69.85	55.58	4.39	57.02	64.31	65.07	2 1/2-16UN	49.23	22.23	9.12	3.18

# KD / MIL-DTL-5015 Series

## Connector Dimensions

KD3102 Class R  
MS3102 Class R  
Box mounting receptacle

Used in junction boxes or as  
an integral part of equipment

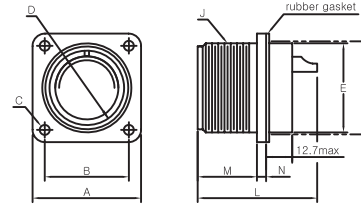

Shell size	□A	□B	∅C	∅D	∅E	∅F	J	L	M	N	
	±0.79	±0.13	+0.25 -0.13	+0.38	-4.78	Mounting Hole max				THD-2A	max
10s /10SL	25.40	18.26	3.05	11.38	19.86	20.62	5/8-24UNEF	30.18	14.27	3.96	1.98
12s	27.79	20.62	3.05	14.15	19.86	20.62	3/4-20UNEF	30.18	14.27	3.96	1.98
12	27.79	20.62	3.05	14.15	19.86	20.62	3/4-20UNEF	41.28	19.05	3.96	1.98
14s	30.18	23.01	3.05	17.32	23.01	23.83	7/8-20UNEF	30.18	14.27	3.96	1.98
14	30.18	23.01	3.05	17.32	23.01	23.83	7/8-20UNEF	41.28	19.05	3.96	1.98
16s	32.54	24.61	3.05	20.50	26.21	26.97	1 -20UNEF	30.18	14.27	3.96	1.98
16	32.54	24.61	3.05	20.50	26.21	26.97	1 -20UNEF	41.28	19.05	3.96	1.98
18	34.93	26.97	3.05	23.67	29.36	30.18	1 1/8-18UNEF	49.23	19.05	5.16	2.39
20	38.10	29.36	3.05	26.87	32.56	33.32	1 1/4-18UNEF	49.23	19.05	5.16	2.39
22	41.28	31.75	3.05	30.02	35.71	36.53	1 3/8-18UNEF	49.23	19.05	5.16	2.39
24	44.45	34.93	3.73	33.20	38.91	39.97	1 1/2-18UNEF	49.23	20.62	5.16	2.39
28	50.80	39.67	3.73	38.76	45.26	46.02	1 3/4-18UNS	49.23	20.62	5.16	2.39
32	57.15	44.45	4.39	45.11	51.61	52.37	2 -18UNS	49.23	22.23	9.12	3.18
36	63.50	49.23	4.39	50.67	57.96	58.72	2 1/4-16UN	49.23	22.23	9.12	3.18

KD3101 Class A  
MS3101 Class A  
Cable connecting plug

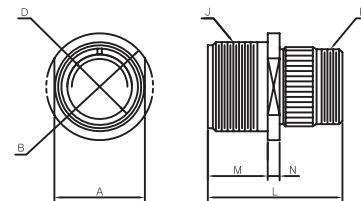

Shell size	A	∅B	∅D	J	K	L	M	N	
	max	max	+0.38	THD-2A	THD-2A	max	+0.79	max	min
10s /10SL	16.26	24.61	11.38	5/8-24UNEF	5/8-24UNEF	38.89	14.27	3.96	1.98
12s	19.43	26.97	14.15	3/4-20UNEF	5/8-24UNEF	42.88	14.27	3.96	1.98
12	19.43	26.97	14.15	3/4-20UNEF	5/8-24UNEF	52.37	19.05	3.96	1.98
14s	22.61	29.36	17.32	7/8-20UNEF	3/4-20UNEF	42.88	14.27	3.96	1.98
14	22.61	29.36	17.32	7/8-20UNEF	3/4-20UNEF	52.37	19.05	3.96	1.98
16s	25.78	31.75	20.50	1 -20UNEF	7/8-20UNEF	42.88	14.27	3.96	1.98
16	25.78	31.75	20.50	1 -20UNEF	7/8-20UNEF	52.37	19.05	3.96	1.98
18	28.96	34.14	23.67	1 1/8-18UNEF	1 -20UNEF	52.37	19.05	5.16	2.39
20	32.13	37.31	26.87	1 1/4-18UNEF	1 3/16-18UNEF	55.58	19.05	5.16	2.39
22	35.31	40.49	30.02	1 3/8-18UNEF	1 3/16-18UNEF	55.58	19.05	5.16	2.39
24	38.48	43.66	33.20	1 1/2-18UNEF	1 7/16-18UNEF	58.72	20.62	5.16	2.39
28	44.83	50.01	38.76	1 3/4-18UNS	1 7/16-18UNEF	58.72	20.62	5.16	2.39
32	51.18	56.36	45.11	2 -18UNS	1 3/4-18UNS	61.93	22.23	9.12	3.18
36	57.53	62.71	50.67	2 1/4-16UN	2 -18UNS	61.93	22.23	9.12	3.18
40	63.88	69.06	57.02	2 1/2-16UN	2 1/4-18UN	61.93	22.23	9.12	3.18

# KD / MIL-DTL-5015 Series

## Connector Dimensions

KD3101 Class E, F  
MS3101 Class E, F  
Cable connecting plug  
(grommet included)

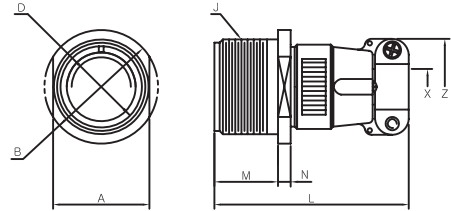

Used for cable extension requirements,  
where mounting provisions are unnecessary

Shell size	A max	ØB max	ØD +0.38	J THD-2A	L max	M +0.79	N		X min	Z ±0.79
							max	min		
10s/10SL	16.26	26.97	11.38	5/8-24UNEF	57.15	14.27	3.96	1.57	7.14	22.23
12s	19.43	26.97	14.15	3/4-20UNEF	57.15	14.27	3.96	1.57	7.14	22.23
12	19.43	26.97	14.15	3/4-20UNEF	66.68	19.05	3.96	1.57	7.14	22.23
14s	22.61	29.36	17.32	7/8-20UNEF	57.15	14.27	3.96	1.57	10.31	26.97
14	22.61	29.36	17.32	7/8-20UNEF	66.68	19.05	3.96	1.57	10.31	26.97
16s	25.78	32.54	20.50	1 -20UNEF	57.15	14.27	3.96	1.57	12.70	29.36
16	25.78	32.54	20.50	1 -20UNEF	66.68	19.05	3.96	1.57	12.70	29.36
18	28.96	34.14	23.67	1 1/8-18UNEF	68.28	19.05	5.16	2.39	13.49	31.75
20	32.13	38.10	26.87	1 1/4-18UNEF	69.85	19.05	5.16	2.39	16.66	37.31
22	35.31	41.28	30.02	1 3/8-18UNEF	69.85	19.05	5.16	2.39	19.05	37.31
24	38.48	44.45	33.20	1 1/2-18UNEF	75.41	20.62	5.16	2.39	19.84	42.88
28	44.83	50.80	38.76	1 3/4-18UNS	76.99	20.62	5.16	2.39	23.42	42.88
32	51.18	57.15	45.11	2 -18UNS	76.99	22.23	9.12	3.18	29.36	51.59
36	57.53	63.50	50.67	2 1/4-16UN	83.34	22.23	9.12	3.18	31.75	57.94

KD3101 Class R  
MS3101 Class R  
Cable connecting plug  
(grommet included)

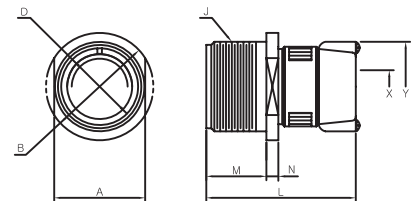

R type has a shorter and lightweight  
endbell than E, F type

Shell size	A max	ØB max	ØD +0.38	J THD-2A	L max	M +0.79	N		X min	Y ±0.25
							max	min		
10s/10SL	16.26	26.97	11.38	5/8-24UNEF	46.69	14.27	3.96	1.57	7.14	23.83
12s	19.43	26.97	14.15	3/4-20UNEF	46.69	14.27	3.96	1.57	7.14	23.83
12	19.43	26.97	14.15	3/4-20UNEF	55.40	19.05	3.96	1.57	7.14	23.83
14s	22.61	29.36	17.32	7/8-20UNEF	46.69	14.27	3.96	1.57	10.31	28.58
14	22.61	29.36	17.32	7/8-20UNEF	55.40	19.05	3.96	1.57	10.31	28.58
16s	25.78	32.54	20.50	1 -20UNEF	46.69	14.27	3.96	1.57	12.70	30.96
16	25.78	32.54	20.50	1 -20UNEF	55.40	19.05	3.96	1.57	12.70	30.96
18	28.96	34.14	23.67	1 1/8-18UNEF	57.94	19.05	5.16	2.39	13.49	35.71
20	32.13	38.10	26.87	1 1/4-18UNEF	57.94	19.05	5.16	2.39	16.66	38.10
22	35.31	41.28	30.02	1 3/8-18UNEF	57.94	19.05	5.16	2.39	19.05	39.67
24	38.48	44.45	33.20	1 1/2-18UNEF	57.94	20.62	5.16	2.39	19.84	46.84
28	44.83	50.80	38.76	1 3/4-18UNS	57.94	20.62	5.16	2.39	23.42	46.84
32	51.18	57.15	45.11	2 -18UNS	58.98	22.23	9.12	3.18	29.36	53.98
36	57.53	63.50	50.67	2 1/4-16UN	58.98	22.23	9.12	3.18	31.75	58.72



# KD / MIL-DTL-5015 Series

## Connector Dimensions

KD3106 Class A  
MS3106 Class A  
Straight plug

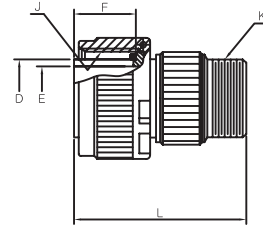

Shell size	$\phi A$ max	$\phi D$ -0.38	$\phi E$ min	F $\pm 0.13$	J THD-2B	K THD-2A	L max
10s/10SL	24.61	11.33	10.20	13.49	5/8-24UNEF	5/8-24UNEF	38.89
12s	26.97	14.10	11.43	13.49	3/4-20UNEF	5/8-24UNEF	42.88
12	26.97	14.10	11.43	18.26	3/4-20UNEF	5/8-24UNEF	52.37
14s	29.36	17.15	13.36	13.49	7/8-20UNEF	3/4-20UNEF	42.88
14	29.36	17.15	13.36	18.26	7/8-20UNEF	3/4-20UNEF	52.37
16s	31.75	20.45	16.54	13.49	1 -20UNEF	7/8-20UNEF	42.88
16	31.75	20.45	16.54	18.26	1 -20UNEF	7/8-20UNEF	52.37
18	34.14	23.62	19.71	18.26	1 1/8-18UNEF	1 -20UNEF	52.37
20	37.31	26.67	23.67	18.26	1 1/4-18UNEF	1 3/16-18UNEF	55.58
22	40.49	29.85	26.06	18.26	1 3/8-18UNEF	1 3/16-18UNEF	55.58
24	43.66	33.02	29.24	18.26	1 1/2-18UNEF	1 7/16-18UNEF	58.72
28	50.01	38.61	34.80	18.26	1 3/4-18UNS	1 7/16-18UNEF	58.72
32	56.36	44.96	41.15	18.26	2 -18UNS	1 3/4-18UNS	61.93
36	62.71	50.29	46.69	18.26	2 1/4-16UN	2 -18UNS	61.93
40	69.06	56.64	52.25	18.26	2 1/2-16UN	2 1/4-18UN	61.93

KD3106 Class E, F  
MS3106 Class E, F  
Straight plug with Integral  
cable clamp and grommet

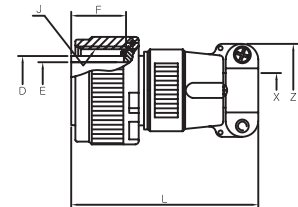

Shell size	$\phi A$ max	$\phi D$ -0.38	$\phi E$ min	F $\pm 0.13$	J THD-2B	L max	X min	Z $\pm 0.79$
10s/10SL	24.61	11.33	10.20	13.49	5/8-24UNEF	57.15	7.14	22.23
12s	26.97	14.10	11.43	13.49	3/4-20UNEF	57.15	7.14	22.23
12	26.97	14.10	11.43	18.26	3/4-20UNEF	66.68	7.14	22.23
14s	29.36	17.15	13.36	13.49	7/8-20UNEF	57.15	10.31	26.97
14	29.36	17.15	13.36	18.26	7/8-20UNEF	66.68	10.31	26.97
16s	31.75	20.45	16.54	13.49	1 -20UNEF	57.15	12.70	29.36
16	31.75	20.45	16.54	18.26	1 -20UNEF	66.68	12.70	29.36
18	34.14	23.62	19.71	18.26	1 1/8-18UNEF	68.28	13.49	31.75
20	37.31	26.67	23.67	18.26	1 1/4-18UNEF	69.85	16.66	37.31
22	40.49	29.85	26.06	18.26	1 3/8-18UNEF	69.85	19.05	37.31
24	43.66	33.02	29.24	18.26	1 1/2-18UNEF	75.41	19.84	42.88
28	50.01	38.61	34.80	18.26	1 3/4-18UNS	76.99	23.42	42.88
32	56.36	44.96	41.15	18.26	2 -18UNS	76.99	29.36	51.59
36	62.71	50.29	46.69	18.26	2 1/4-16UN	83.34	31.75	57.94

# KD / MIL-DTL-5015 Series

## Connector Dimensions

KD3106 Class R  
MS3106 Class R  
Straight plug with grommet

Identical in purpose to the  
MS3106F

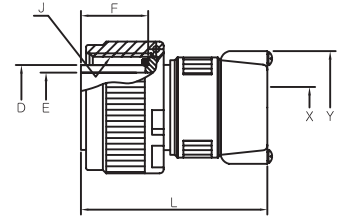
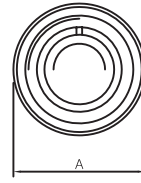

Shell size	$\phi A$ max	$\phi D$ -0.38	$\phi E$ min	F $\pm 0.13$	J THD-2B	L max	X min	Y $\pm 0.25$
10s/10SL	24.61	11.33	10.20	13.49	5/8-24UNEF	46.69	7.14	23.83
12s	26.97	14.10	11.43	13.49	3/4-20UNEF	46.69	7.14	23.83
12	26.97	14.10	11.43	18.26	3/4-20UNEF	55.40	7.14	23.83
14s	29.36	17.15	13.36	13.49	7/8-20UNEF	46.69	10.31	28.58
14	29.36	17.15	13.36	18.26	7/8-20UNEF	55.40	10.31	28.58
16s	31.75	20.45	16.54	13.49	1 -20UNEF	46.69	12.70	30.96
16	31.75	20.45	16.54	18.26	1 -20UNEF	55.40	12.70	30.96
18	34.14	23.62	19.71	18.26	1 1/8-18UNEF	57.94	13.49	35.71
20	37.31	26.67	23.67	18.26	1 1/4-18UNEF	57.94	16.66	38.10
22	40.49	29.85	26.06	18.26	1 3/8-18UNEF	57.94	19.05	39.67
24	43.66	33.02	29.24	18.26	1 1/2-18UNEF	57.94	19.84	46.84
28	50.01	38.61	34.80	18.26	1 3/4-18UNS	57.94	23.42	46.84
32	56.36	44.96	41.15	18.26	2 -18UNS	58.98	29.36	53.98
36	62.71	50.29	46.69	18.26	2 1/4-16UN	58.98	31.75	58.72

KD3108 Class A  
MS3108 Class A  
90° Angle plug

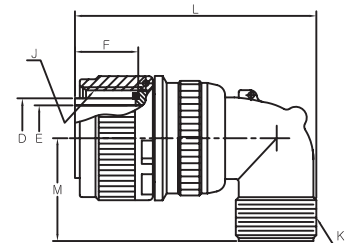
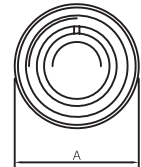

Shell size	$\phi A$ max	$\phi D$ -0.38	$\phi E$ min	F $\pm 0.13$	J THD-2B	K THD-2A	L max	M max
10s/10SL	24.61	11.33	10.20	13.49	5/8-24UNEF	5/8-24UNEF	46.02	25.40
12s	26.97	14.10	11.43	13.49	3/4-20UNEF	5/8-24UNEF	50.80	26.97
12	26.97	14.10	11.43	18.26	3/4-20UNEF	5/8-24UNEF	57.15	26.97
14s	29.36	17.15	13.36	13.49	7/8-20UNEF	3/4-20UNEF	53.98	28.58
14	29.36	17.15	13.36	18.26	7/8-20UNEF	3/4-20UNEF	58.72	28.58
16s	31.75	20.45	16.54	13.49	1 -20UNEF	7/8-20UNEF	60.33	30.18
16	31.75	20.45	16.54	18.26	1 -20UNEF	7/8-20UNEF	65.07	30.18
18	34.14	23.62	19.71	18.26	1 1/8-18UNEF	1 -20UNEF	68.28	33.32
20	37.31	26.67	23.67	18.26	1 1/4-18UNEF	1 3/16-18UNEF	76.99	34.93
22	40.49	29.85	26.06	18.26	1 3/8-18UNEF	1 3/16-18UNEF	76.99	34.93
24	43.66	33.02	29.24	18.26	1 1/2-18UNEF	1 7/16-18UNEF	86.51	39.67
28	50.01	38.61	34.80	18.26	1 3/4-18UNS	1 7/16-18UNEF	86.51	39.67
32	56.36	44.96	41.15	18.26	2 -18UNS	1 3/4-18UNS	95.25	47.63
36	62.71	50.29	46.69	18.26	2 1/4-16UN	2 -18UNS	100.03	52.37

# KD / MIL-DTL-5015 Series

## Connector Dimensions

KD3108 Class E, R  
MS3108 Class E, R  
90° Angle plug  
(grommet included)

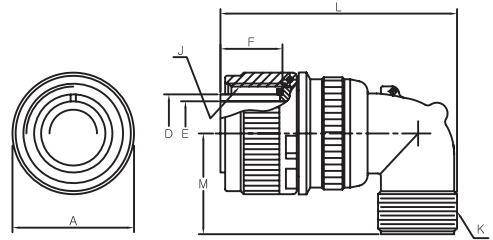

Shell size	$\phi A$	$\phi D$	$\phi E$	F	J	K	L	M
	max	-0.38	min	$\pm 0.13$	THD-2B	THD-2A	max	max
10s / 10SL	24.61	11.33	10.20	13.49	5/8-24UNEF	5/8-24UNEF	46.02	25.40
12s	26.97	14.10	11.43	13.49	3/4-20UNEF	5/8-24UNEF	50.80	26.97
12	26.97	14.10	11.43	18.26	3/4-20UNEF	5/8-24UNEF	57.15	26.97
14s	29.36	17.15	13.36	13.49	7/8-20UNEF	3/4-20UNEF	53.98	28.58
14	29.36	17.15	13.36	18.26	7/8-20UNEF	3/4-20UNEF	58.72	28.58
16s	31.75	20.45	16.54	13.49	1 -20UNEF	7/8-20UNEF	60.33	30.18
16	31.75	20.45	16.54	18.26	1 -20UNEF	7/8-20UNEF	65.07	30.18
18	34.14	23.62	19.71	18.26	1 1/8-18UNEF	1 -20UNEF	68.28	33.32
20	37.31	26.67	23.67	18.26	1 1/4-18UNEF	1 3/16-18UNEF	76.99	34.93
22	40.49	29.85	26.06	18.26	1 3/8-18UNEF	1 3/16-18UNEF	76.99	34.93
24	43.66	33.02	29.24	18.26	1 1/2-18UNEF	1 7/16-18UNEF	86.51	39.67
28	50.01	38.61	34.80	18.26	1 3/4-18UNS	1 7/16-18UNEF	86.51	39.67
32	56.36	44.96	41.15	18.26	2 -18UNS	1 3/4-18UNS	95.25	47.63
36	62.71	50.29	46.69	18.26	2 1/4-16UN	2 -18UNS	100.03	52.37

KD3108 Class F  
MS3108 Class F  
90° Angle plug with  
M85049/41 cable clamp  
and grommet

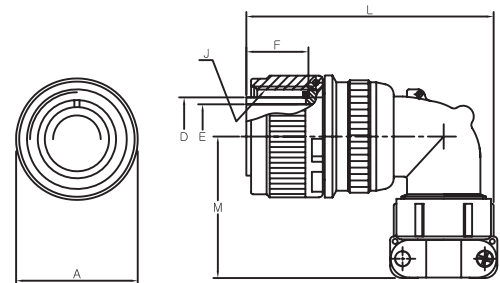

Shell size	$\phi A$	$\phi D$	$\phi E$	F	J	L	M
	max	-0.38	min	$\pm 0.13$	THD-2B	max	max
10s / 10SL	24.61	11.33	10.20	13.49	5/8-24UNEF	55.58	38.10
12s	26.97	14.10	11.43	13.49	3/4-20UNEF	55.58	38.10
12	26.97	14.10	11.43	18.26	3/4-20UNEF	64.29	38.10
14s	29.36	17.15	13.36	13.49	7/8-20UNEF	58.72	40.49
14	29.36	17.15	13.36	18.26	7/8-20UNEF	68.28	40.49
16s	31.75	20.45	16.54	13.49	1 -20UNEF	61.11	42.88
16	31.75	20.45	16.54	18.26	1 -20UNEF	70.64	42.88
18	34.14	23.62	19.71	18.26	1 1/8-18UNEF	72.24	45.24
20	37.31	26.67	23.67	18.26	1 1/4-18UNEF	82.55	50.01
22	40.49	29.85	26.06	18.26	1 3/8-18UNEF	82.55	50.80
24	43.66	33.02	29.24	18.26	1 1/2-18UNEF	94.46	53.98
28	50.01	38.61	34.80	18.26	1 3/4-18UNS	94.46	55.58
32	56.36	44.96	41.15	18.26	2 -18UNS	106.38	65.89
36	62.71	50.29	46.69	18.26	2 1/4-16UN	109.14	69.06

# KD / MIL-DTL-5015 Series

## Connector Dimensions

KD3103  
MS3103  
Potting seal box mounting receptacle

Supplied with a resilient insulator and nylon potting cup with a threaded attachment ring

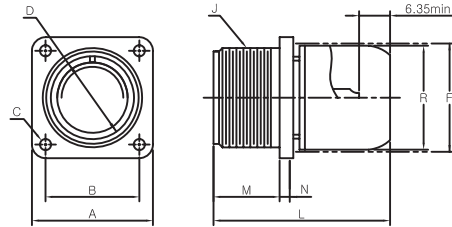

Shell size	□A	□B	φC	φD	R	φF	J	L	M	N	
	±0.79	±0.13	+0.25 -0.13	+0.38	max	Mounting Hole				max	min
10s/10SL	25.40	18.26	3.05	11.38	21.92	20.62	5/8-24UNEF	38.89	14.27	3.96	1.65
12S	27.79	20.62	3.05	14.15	21.92	20.62	3/4-20UNEF	38.89	14.27	3.96	1.65
12	27.79	20.62	3.05	14.15	21.92	20.62	3/4-20UNEF	49.99	19.05	3.96	3.58
14S	30.18	23.01	3.05	17.32	23.90	23.83	7/8-20UNEF	38.89	14.27	3.96	1.65
14	30.18	23.01	3.05	17.32	23.90	23.83	7/8-20UNEF	49.99	19.05	3.96	3.58
16S	32.54	24.61	3.05	20.50	27.08	26.97	1 -20UNEF	38.89	14.27	3.96	1.65
16	32.54	24.61	3.05	20.50	27.08	26.97	1 -20UNEF	49.99	19.05	3.96	3.58
18	34.93	26.97	3.05	23.67	30.66	30.18	1 1/8-18UNEF	49.99	19.05	5.16	3.58
20	38.10	29.36	3.05	26.87	33.83	33.32	1 1/4-18UNEF	55.58	19.05	5.16	3.58
22	41.28	31.75	3.05	30.02	37.01	36.53	1 3/8-18UNEF	55.58	19.05	5.16	3.58
24	44.45	34.93	3.73	33.20	40.18	39.97	1 1/2-18UNEF	55.58	20.62	5.16	5.74
28	50.80	39.67	3.73	38.76	46.53	46.02	1 3/4-18UNS	55.58	20.62	5.16	5.74
32	57.15	44.45	4.39	45.11	52.88	52.37	2 -18UNS	55.58	22.23	9.12	5.74
36	63.50	49.23	4.39	50.67	60.83	58.72	2 1/4-16UN	55.58	22.23	9.12	5.74
40	69.85	55.58	4.39	57.02	65.89	65.07	2 1/2-16UN	55.58	22.23	9.12	5.74

KD25183  
MS25183  
Potting seal plug

Supplied with a resilient insulator and nylon potting cup with a threaded attachment ring

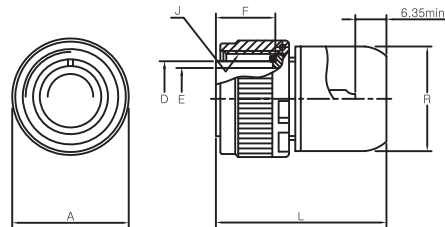

Shell size	φA	φD	φE	F	J	L	R
	max	-0.38	min	±0.13			
10s/10SL	24.61	11.33	10.20	13.49	5/8-24UNEF	38.10	21.92
12S	26.97	14.10	11.43	13.49	3/4-20UNEF	38.10	21.92
12	26.97	14.10	11.43	18.26	3/4-20UNEF	48.41	21.92
14S	29.36	17.15	13.36	13.49	7/8-20UNEF	38.10	23.90
14	29.36	17.15	13.36	18.26	7/8-20UNEF	48.41	23.90
16S	31.75	20.45	16.54	13.49	1 -20UNEF	38.10	27.08
16	31.75	20.45	16.54	18.26	1 -20UNEF	48.41	27.08
18	34.14	23.62	19.71	18.26	1 1/8-18UNEF	48.41	30.66
20	37.31	26.67	23.67	18.26	1 1/4-18UNEF	55.58	33.83
22	40.49	29.85	26.06	18.26	1 3/8-18UNEF	55.58	37.01
24	43.66	33.02	29.24	18.26	1 1/2-18UNEF	55.58	40.18
28	50.01	38.61	34.80	18.26	1 3/4-18UNS	55.58	46.53
32	56.36	44.96	41.15	18.26	2 -18UNS	55.58	52.88
36	62.71	50.29	46.69	18.26	2 1/4-16UN	55.58	60.83
40	69.06	56.64	52.25	18.26	2 1/2-16UN	55.58	65.89

# KD / MIL-DTL-5015 Series

## Exploded view

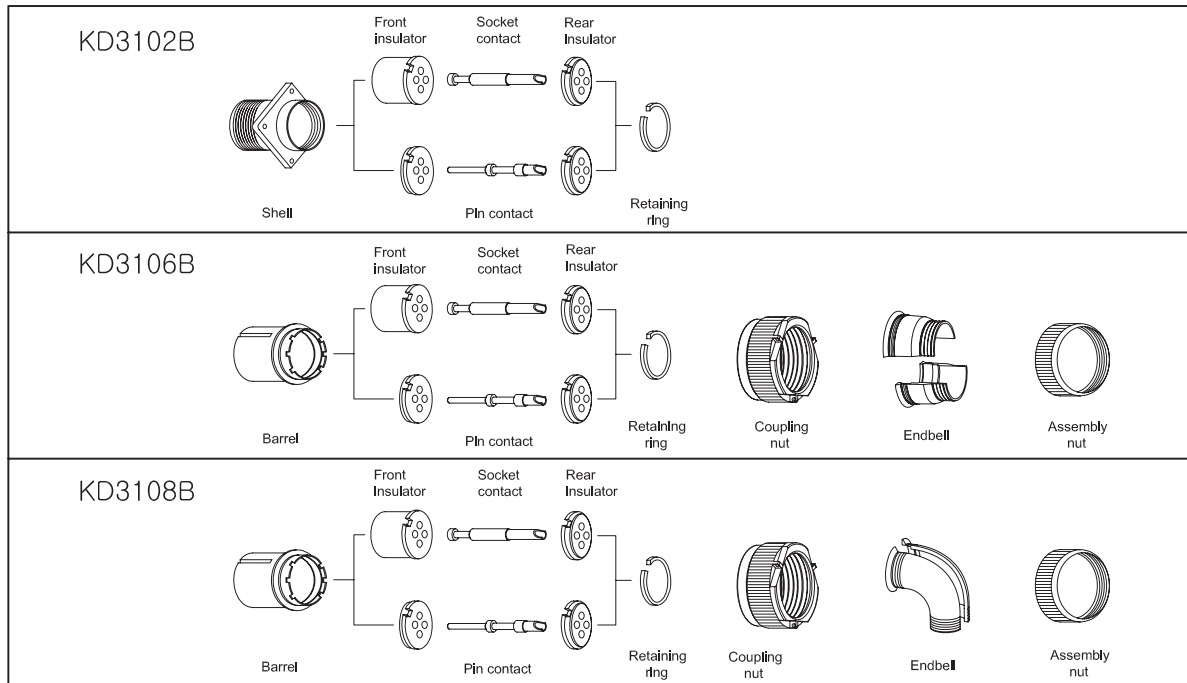

KD3102B  
MS3102B  
Box mounting receptacle

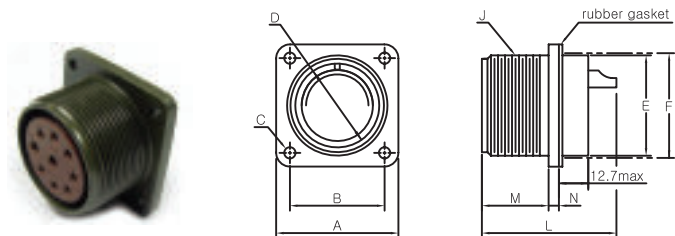

Shell size	□A ±0.79	□B ±0.13	∅C +0.25 -0.13	∅D +0.38	∅E -0.78	∅F Mounting Hole	J THD-2B	L max	M +0.79	N	
										max	min
14s	30.18	23.01	3.05	17.32	23.01	23.83	7/8-20UNEF	30.25	14.27	3.96	1.57
16	32.54	24.61	3.05	20.50	26.21	26.97	1 -20UNEF	44.45	19.05	3.96	1.98
18	34.93	26.97	3.05	23.67	29.36	30.18	1 1/8-18UNEF	49.23	19.05	5.16	2.39
20	38.10	29.36	3.05	26.87	32.56	33.32	1 1/4-18UNEF	49.23	19.05	5.16	2.39
22	41.28	31.75	3.05	30.02	35.71	36.53	1 3/8-18UNEF	49.23	19.05	5.16	2.39
24	44.45	34.93	3.73	33.20	38.91	39.97	1 1/2-18UNEF	49.23	20.62	5.16	2.39
28	50.80	39.67	3.73	38.76	45.26	46.02	1 3/4-18UNS	49.23	20.62	5.16	2.39
32	57.15	44.45	4.39	45.11	51.61	52.37	2 -18UNS	49.23	22.23	5.16	2.39
36	63.50	49.23	4.39	50.67	57.96	58.72	2 1/4-16UN	49.23	22.23	5.16	2.39

# KD / MIL-DTL-5015 Series

## Connector Dimensions

KD3106B  
MS3106B  
Straight plug and split endbell

Wire soldering and maintenance  
simplified with a split type endbell

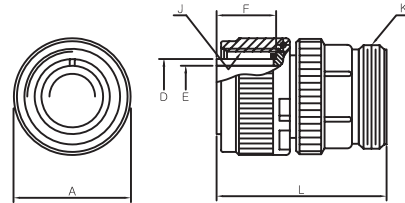

Shell size	$\phi A$ max	$\phi D$ -0.38	$\phi E$ min	F $\pm 0.13$	L max	J THD-2B	K THD-2A
14s	29.36	17.15	13.36	13.49	42.88	7/8-20UNEF	3/4-20UNEF
16	31.75	20.45	16.54	18.26	52.37	1 -20UNEF	7/8-20UNEF
18	34.14	23.62	19.71	18.26	52.37	1 1/8-18UNEF	1 -20UNEF
20	37.31	26.67	23.67	18.26	55.58	1 1/4-18UNEF	1 3/16-18UNEF
22	40.49	29.85	26.06	18.26	55.58	1 3/8-18UNEF	1 3/16-18UNEF
24	43.66	33.02	29.24	18.26	58.72	1 1/2-18UNEF	1 7/16-18UNEF
28	50.01	38.61	34.80	18.26	58.72	1 3/4-18UNS	1 7/16-18UNEF
32	56.36	44.96	41.15	18.26	61.93	2 -18UNS	1 3/4-18UNS
36	62.71	50.29	46.69	18.26	61.93	2 1/4-16UN	2 -18UNS

KD3108B  
MS3108B  
90° Angle plug and split endbell

Convenient for use in  
narrow places

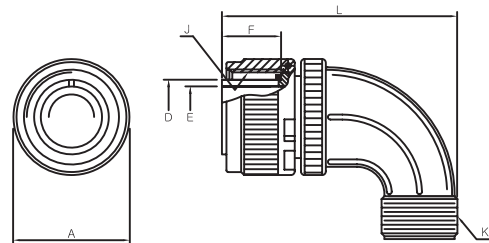

Shell size	$\phi A$ max	$\phi D$ -0.38	$\phi E$ min	F $\pm 0.13$	L max	J THD-2B	K THD-2A
14s	29.36	17.15	13.36	13.49	53.98	7/8-20UNEF	3/4-20UNEF
16	31.75	20.45	16.54	18.26	65.07	1 -20UNEF	7/8-20UNEF
18	34.14	23.62	19.71	18.26	68.28	1 1/8-18UNEF	1 -20UNEF
20	37.31	26.67	23.67	18.26	76.99	1 1/4-18UNEF	1 3/16-18UNEF
22	40.49	29.85	26.06	18.26	76.99	1 3/8-18UNEF	1 3/16-18UNEF
24	43.66	33.02	29.24	18.26	86.51	1 1/2-18UNEF	1 7/16-18UNEF
28	50.01	38.61	34.80	18.26	86.51	1 3/4-18UNS	1 7/16-18UNEF
32	56.36	44.96	41.15	18.26	95.25	2 -18UNS	1 3/4-18UNS
36	62.71	50.29	46.69	18.26	100.03	2 1/4-16UN	2 -18UNS

# KD / MIL-DTL-5015 Series

## Accessories

KD3105  
MS3105  
Dummy stowage receptacle

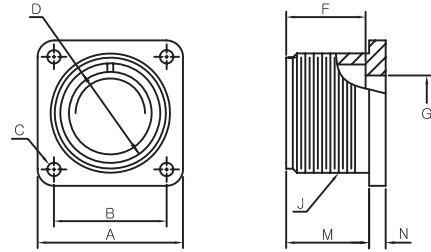

Shell size	□A	□B	∅C	∅D	F	G	J	M	N	
	±0.79	±0.13	+0.25 -0.13	+0.38	+0.79	±0.79	THD-2A	+0.79	max	min
10SL	25.40	18.26	3.05	11.38	14.28	11.43	5/8-24UNEF	14.27	3.96	1.98
12S	27.79	20.62	3.05	14.15	14.28	11.43	3/4-20UNEF	14.27	3.96	1.98
12	27.79	20.62	3.05	14.15	19.05	11.43	3/4-20UNEF	19.05	3.96	1.98
14S	30.18	23.01	3.05	17.32	14.28	13.36	7/8-20UNEF	14.27	3.96	1.98
14	30.18	23.01	3.05	17.32	19.05	13.36	7/8-20UNEF	19.05	3.96	1.98
16S	32.54	24.61	3.05	20.50	14.28	16.41	1 -20UNEF	14.27	3.96	1.98
16	32.54	24.61	3.05	20.50	19.05	16.41	1 -20UNEF	19.05	3.96	1.98
18	34.93	26.97	3.05	23.67	19.05	19.58	1 1/8-18UNEF	19.05	5.16	2.39
20	38.10	29.36	3.05	26.87	19.05	23.55	1 1/4-18UNEF	19.05	5.16	2.39
22	41.28	31.75	3.05	30.02	19.05	25.93	1 3/8-18UNEF	19.05	5.16	2.39
24	44.45	34.93	3.73	33.20	19.05	29.21	1 1/2-18UNEF	20.62	5.16	2.39
28	50.80	39.67	3.73	38.76	19.05	34.67	1 3/4-18UNS	20.62	5.16	2.39
32	57.15	44.45	4.39	45.11	19.05	41.15	2 -18UNS	22.23	9.12	3.18
36	63.50	49.23	4.39	50.67	19.05	46.56	2 1/4-16UN	22.23	9.12	3.18
40	69.85	55.58	4.39	57.02	19.05	52.12	2 1/2-16UN	22.23	9.12	3.18

KD2120

Junction shell

Attached to the panel on the  
rearside to protect the cable

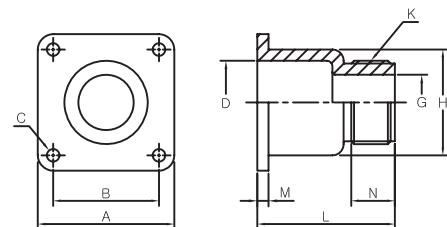

Shell size	□A	□B	∅C	∅D	∅G	∅H	K	L	M	N
	±0.79	±0.13	+0.25 -0.13	±0.41	±0.41	±0.41	THD-2A	max	±0.41	min
10SL	25.40	18.26	3.05	16.31	11.10	19.00	5/8-24UNEF	21.01	1.70	9.50
12S	27.79	20.62	3.05	16.31	11.10	19.00	5/8-24UNEF	21.01	1.70	9.50
12	27.79	20.62	3.05	16.31	11.10	19.00	5/8-24UNEF	21.01	1.70	9.50
14S	30.18	23.01	3.05	19.20	14.30	21.79	3/4-20UNEF	21.01	1.70	9.50
14	30.18	23.01	3.05	19.20	14.30	21.79	3/4-20UNEF	21.01	1.70	9.50
16S	32.54	24.61	3.05	22.40	17.50	24.99	7/8-20UNEF	23.01	1.70	9.50
16	32.54	24.61	3.05	22.40	17.50	24.99	7/8-20UNEF	23.01	1.70	9.50
18	34.93	26.97	3.05	25.10	20.19	28.40	1 -20UNEF	29.01	2.21	9.50
20	38.10	29.36	3.05	29.79	23.01	32.51	1 3/16-18UNEF	32.99	2.21	9.50
22	41.28	31.75	3.05	32.31	23.19	35.71	1 3/16-18UNEF	32.00	2.21	9.50
24	44.45	34.93	3.73	35.51	29.49	38.89	1 7/16-18UNEF	35.00	2.21	9.50
28	50.80	39.67	3.73	42.09	29.79	45.11	1 7/16-18UNEF	34.01	2.21	9.50
32	57.15	44.45	4.39	48.11	37.49	51.51	1 3/4-18UNS	35.00	3.20	11.10
36	63.50	49.23	4.39	54.51	43.79	57.81	2 -18UNS	35.00	3.20	12.70

# KD / MIL-DTL-5015 Series

KD25042  
MS25042  
Dust protective caps for plug  
Used with MS3106  
and MS3108 plugs

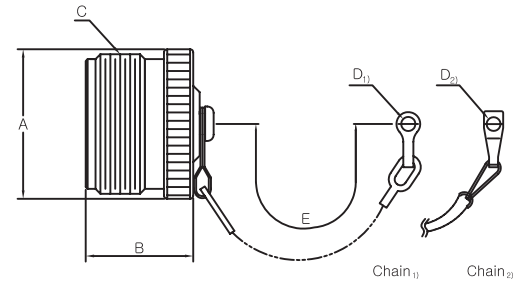

Order No.	Shell size	$\phi A$ max	B max	C THD-2B	$\phi D_1$ +0.15 -0.05	$E_1$ $\pm 10.0$	$\phi D_2$ +0.25 -0.13	$\phi E_2$ $\pm ONE$ LINK
KD25042-10D	10SL	17.45	16.66	5/8-24UNEF	3.80	125.0	3.96	101.6
KD25042-12D	12s & 12	20.62	21.44	3/4-20UNEF	3.80	125.0	3.96	114.3
KD25042-14D	14s & 14	23.80	21.44	7/8-20UNEF	3.80	125.0	3.96	114.3
KD25042-16D	16s & 16	26.97	21.44	1 -20UNEF	3.80	125.0	3.96	114.3
KD25042-18D	18	30.15	21.44	1 1/8-18UNEF	3.80	125.0	3.96	114.3
KD25042-20D	20	33.32	21.44	1 1/4-18UNEF	3.80	125.0	4.75	127.0
KD25042-22D	22	36.50	21.44	1 3/8-18UNEF	3.80	125.0	4.75	139.7
KD25042-24D	24	39.67	21.44	1 1/2-18UNEF	3.80	125.0	4.75	196.9
KD25042-28D	28	46.02	21.44	1 3/4-18UNS	3.80	173.0	4.75	196.9
KD25042-32D	32	52.37	21.44	2 -18UNS	3.80	173.0	5.54	196.9
KD25042-36D	36	58.72	21.44	2 1/4-18UNS	3.80	173.0	5.54	196.9
KD25042-40D	40	65.07	21.44	2 1/2-16UN	3.80	173.0	5.54	196.9

KD25043  
MS25043  
Dust protective caps for receptacle  
Used with MS3100, MS3101  
and MS3102 receptacles

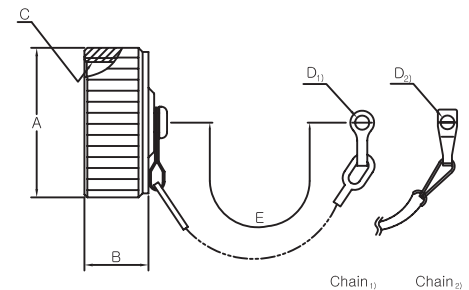

Order No.	Shell size	$\phi A$ max	B max	C THD-2B	$\phi D_1$ +0.15 -0.05	$E_1$ $\pm 10.0$	$\phi D_2$ +0.25 -0.13	$\phi E_2$ $\pm ONE$ LINK
KD25043-10D	10SL	20.70	11.91	5/8-24UNEF	3.80	125.0	3.56	101.6
KD25043-12D	12s & 12	25.40	11.91	3/4-20UNEF	3.80	125.0	3.56	114.3
KD25043-14D	14s & 14	28.58	11.91	7/8-20UNEF	3.80	125.0	3.56	114.3
KD25043-16D	16s & 16	30.18	11.91	1 -20UNEF	3.80	125.0	3.56	114.3
KD25043-18D	18	34.14	11.91	1 1/8-18UNEF	3.80	125.0	3.56	114.3
KD25043-20D	20	37.31	11.91	1 1/4-18UNEF	3.80	125.0	3.56	127.0
KD25043-22D	22	40.49	11.91	1 3/8-18UNEF	3.80	125.0	3.56	139.7
KD25043-24D	24	43.66	11.91	1 1/2-18UNEF	3.80	125.0	4.34	196.9
KD25043-28D	28	50.01	13.49	1 3/4-18UNS	3.80	173.0	4.34	196.9
KD25043-32D	32	56.36	13.49	2 -18UNS	3.80	173.0	4.75	196.9
KD25043-36D	36	62.71	13.49	2 1/4-18UNS	3.80	173.0	4.75	196.9
KD25043-40D	40	69.06	13.49	2 1/2-16UN	3.80	173.0	4.75	196.9

Note : Chain 1) - Kukdong standard (material - copper alloy)  
Chain 2) - Customer's option (material - stainless steel)



# KD / MIL-DTL-5015 Series

KD85049 / 41  
M85049 / 41  
Cable clamp

For plugs and receptacles  
that have an endbell with  
external conduit threads

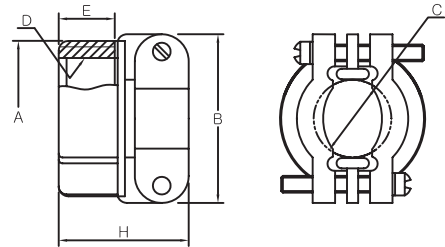

Order No.	Shell size	A ±0.79	B ±0.79	φC max	D THD-2B	E ±0.41	H ±0.79
KD85049 / 41-4A	10SL, 12s & 12	20.62	22.23	7.92	5/8-24UNEF	10.31	20.62
KD85049 / 41-6A	14s & 14	24.61	26.97	11.13	3/4-20UNEF	10.31	22.23
KD85049 / 41-8A	16s & 16	27.79	29.36	14.27	7/8-20UNEF	10.31	23.83
KD85049 / 41-10A	18	30.18	31.75	15.88	1 -20UNEF	10.31	23.83
KD85049 / 41-12A	20, 22	34.93	37.31	19.05	1 3/16-18UNEF	10.31	23.83
KD85049 / 41-16A	24, 28	42.06	42.88	23.83	1 7/16-18UNEF	10.31	26.19
KD85049 / 41-20A	32	51.59	51.59	31.75	1 3/4-18UNS	11.91	27.79
KD85049 / 41-24A	36	56.36	57.94	34.93	2 -18UNS	13.49	29.36

KD3420  
MS3420  
Bushing for cable clamps

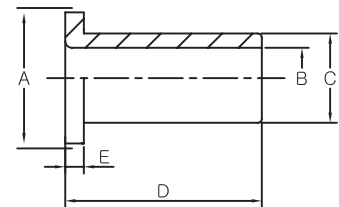
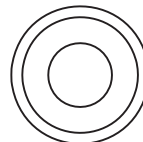

Order No.	Shell size	φA <sub>1</sub> ±0.41	φA <sub>2</sub> ±0.41	φB ±0.41	φC ±0.41	D ±0.79	E <sub>1</sub> ±0.41	E <sub>2</sub> ±0.41
KD3420-4	10SL, 12s & 12	14.66	12.83	5.59	7.67	69.85	1.60	1.57
KD3420-6	14s & 14	17.76	15.72	7.92	10.85	66.68	1.60	1.57
KD3420-8	16s & 16	20.96	18.90	11.10	14.02	63.50	1.60	1.57
KD3420-10	18	24.09	22.58	14.27	15.62	60.33	1.60	1.57
KD3420-12	20, 22	27.75	27.53	15.88	18.80	57.15	1.60	1.57
KD3420-16	24, 28	34.79	33.38	19.05	23.55	53.98	1.60	1.57
KD3420-20	32	42.93	40.59	23.80	31.50	50.80	1.60	1.57
KD3420-24	36	49.26	46.91	31.75	34.67	47.63	1.60	1.57

Note : 1) – Kukdong standard  
2) – Customer's option

# KD / MIL-DTL-5015 Series

KD3057  
MS3057  
Cable clamp

For plugs and receptacles that have an endbell with external conduit threads

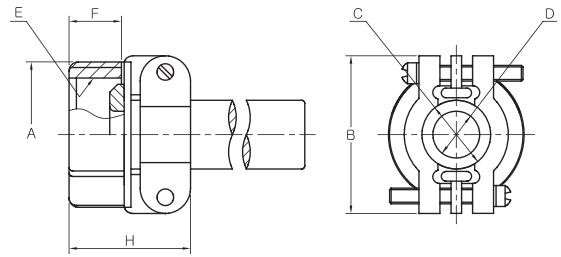

Order No.	Shell size	A ±0.79	B ±0.79	φC ±0.41	φD ±0.41	E THD-2B	F ±0.41	H ±0.79
KD3057-4A	10SL, 12s & 12	20.62	22.23	7.67	5.59	5/8-24UNEF	10.31	20.62
KD3057-6A	14s & 14	24.61	26.97	10.85	7.92	3/4-20UNEF	10.31	22.23
KD3057-8A	16s & 16	27.79	29.36	14.02	11.10	7/8-20UNEF	10.31	23.83
KD3057-10A	18	30.18	31.75	15.62	14.27	1 -20UNEF	10.31	23.83
KD3057-12A	20, 22	34.93	37.31	18.80	15.88	1 3/16-18UNEF	10.31	23.83
KD3057-16A	24, 28	42.06	42.88	23.55	19.05	1 7/16-18UNEF	10.31	26.19
KD3057-20A	32	51.59	51.59	31.50	23.80	1 3/4-18UNS	11.91	27.79
KD3057-24A	36	56.36	57.94	34.67	31.75	2 -18UNS	13.49	29.36

KD90376  
MS90376  
The polyethylene dust cap

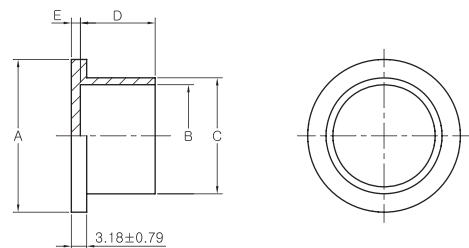

Order No.	Shell size	A ±0.79	B ±0.25	C ±0.25	D ±0.79	E ±0.25
KD90376-10	10SL	21.34	15.37	16.89	12.70	1.02
KD90376-12	12s & 12	24.64	18.29	19.69	12.70	1.02
KD90376-14	14s & 14	28.58	21.59	22.99	12.70	1.14
KD90376-16	16s & 16	30.99	24.71	26.29	12.70	1.14
KD90376-18	18	33.78	27.76	29.34	14.27	1.14
KD90376-20	20	37.21	31.27	33.05	14.27	1.27
KD90376-22	22	40.39	34.03	35.81	14.27	1.27
KD90376-24	24	43.18	37.16	38.94	14.27	1.27
KD90376-28	28	49.53	43.56	45.47	14.27	1.40
KD90376-32	32	56.39	49.91	51.82	14.27	1.40
KD90376-36	36	61.85	56.26	58.17	15.24	1.40

# KD / MIL-DTL-5015 Series

## Components

	KD3106R Straight Plug	KD3106E/F Straight Plug	KD3108E/R 90° Plug	KD3108F 90° Plug	KD25183
Endbell					
Ferrule					
Grommet					
Coupling Nut					
Pin Contacts					
Insulator					
Barrel					
O-Ring		★ 		★ 	

★ O-Ring is also applied in KD3106E/F & KD3108F











**극동전자정밀주식회사**

**KUKDONG Electronic Precision Co., Ltd.**

제 품문의(Customer Inquiry) : [webmaster@kdep.co.kr](mailto:webmaster@kdep.co.kr)

---

**본사 및 제1공장**

인천광역시 서구 원창동 382-81번지  
TEL : 032-582-0071 (내선 0번)  
FAX : 032-582-0076

**Head Office & 1st Factory**

#382-81, Wonchang-Dong, Seo-Gu, Incheon, Korea  
TEL : +82-(0)32-582-0071 (Ext. 0)  
FAX : +82-(0)32-582-0076

---

**제2공장**

인천광역시 서구 원창동 382-73번지  
TEL : 032-582-0071 (내선 0번)  
FAX : 032-582-0075

**2nd Factory**

#382-73, Wonchang-Dong, Seo-Gu, Incheon, Korea  
TEL : +82-(0)32. 582. 0071 (내선 0번)  
FAX : +82-(0)32. 582. 0075

※ 본 카탈로그의 내용은 제품향상을 위해 예고없이 일부 수정 및 변경될 수 있습니다.  
※ 제품의 색상은 인쇄과정으로 인해 실제와 약간 다를수 있습니다.