

Bearing specification tables

Contents

Standard bearings

Deep groove ball bearings	B 4
Single-row	
Open type.....	B 8
Shielded/sealed type	B 20
Snap ring groove/locating snap ring type	B 32
Extra-small, miniature ball bearings	
Open/shielded/sealed type.....	B 38
Flanged type (open/shielded type)	B 44
Double-row	B 50
Angular contact ball bearings	B 52
Single-row	B 60
Matched pair	B 92
Double-row	B 124
Four-point contact ball bearings	B 130
Self-aligning ball bearings	B 134
Open type	B 136
Sealed type	B 144
Extended inner ring type	B 148
Adapter assemblies for self-aligning ball bearings ...	B 150
Cylindrical roller bearings	B 154
Single-row	B 158
Thrust collars	B 184
Double-row	B 194
Tapered roller bearings	B 200
Single-row	
Metric series	B 204
Inch series	B 236
Double-row	
TDO type	B 280
TDI type.....	B 296

Spherical roller bearings	B 302
Spherical roller bearings	B 306
Adapter assemblies for spherical roller bearings	B 330
Withdrawal sleeves for spherical roller bearings	B 338
Thrust ball bearings	B 348
Single direction	B 350
Double direction	B 360
Spherical thrust roller bearings	B 366
Needle roller bearings	B 374
Needle roller and cage assemblies ...	B 388
Drawn cup type	B 402
Machined ring type	B 424
Thrust	B 440
Stud type track rollers (cam followers)	B 450
Yoke type track rollers (roller followers)	B 454
(Miniature one-way clutches)	B 458
Ball bearing units	B 462
Pillow block type	
With set screws	B 470
With adapter	B 476
Thick section	B 480
Light duty	B 482
“Compact” series	B 484
Stainless-series	B 486
Pressed steel.....	B 488
Square-flanged type	B 490
Square-flanged type with spigot joint	B 496
Rhombic-flanged type	B 500
Light duty	B 504
“Compact” series	B 506
Stainless-series	B 508

(Ball bearing units)

Round-flanged type with spigot joint	B 510
Pressed steel round-flanged type	B 514
Pressed steel rhombic-flanged type	B 516
Take-up type	B 518
Cartridge type	B 524
Ball bearings for units	
Cylindrical bore type (with set screws)	B 528
Tapered bore type (with adapter) ...	B 534
Cylindrical bore type (with eccentric locking collar)...	B 538

Plummer blocks

Split type	
Standard	B 544
Flat bottom	B 552
Flat bottom (different/large bore type)	B 558
Large size	B 564
One-piece type	B 570

Special purpose bearings

Ceramic & EXSEV bearing series	C 1
Vacuum environment.....	C 9
Clean environment	C 13
Ceramic bearings	C 17
Hybrid ceramic bearings.....	C 21
Linear ball bearings for vacuum	C 25
K-series super thin section ball bearings	C 27
Deep groove type	}
Angular contact type	
Four-point contact type	
Sealed type	

Bearings for machine tool spindles (for support of axial loading)

Double direction	
angular contact thrust ball bearings	C 53
Matched pair angular contact ball bearings	C 59

Precision ball screw support bearings

and bearing units	C 65
Support bearings.....	C 67
Support bearing units.....	C 69

Full complement type cylindrical roller bearings for crane sheaves

Shielded type	C 73
Open type	C 77

Rolling mill roll neck bearings

Four-row cylindrical roller bearings.....	C 85
Four-row tapered roller bearings.....	C 103
Sealed type four-row tapered roller bearings...	C 127

Bearings for railway

rolling stock axle journals	C 139
Cylindrical roller bearings	C 143
Sealed type cylindrical roller bearings	C 145
Sealed type tapered roller bearings	
(ABU bearing)	C 147

Linear ball bearings

Linear ball bearings	C 153
Flanged type	C 159

Accessories

Locknuts	C 165
Lockwashers	C 171
Lock plates	C 173

Deep groove ball bearings

Deep groove ball bearings are available in a variety of sizes, and are the most popular of all rolling bearings. This type of bearing supports radial load and a certain degree of axial load in both directions simultaneously.

- Shielded / sealed type
 - Simplifies sealing structure of applications.
 - Greasing is not necessary because bearings are pre-lubricated.
 - Table 1 on the next page lists major shielded and sealed bearing types and compares their performance.
- With locating snap ring
 - Bearings with a locating snap ring can be fit to the housing easily, as the locating snap ring facilitates axial positioning.
- Extra-small ball bearings and miniature ball bearings
 - The open type is widely used. Also available are the shielded/sealed type and the flanged type; the latter is easily positioned in the axial direction.



Single-row deep groove ball bearings



Open type

Bore diameter 10 – 500 mm



Shielded/sealed type

Bore diameter 10 – 220 mm



With snap ring groove With locating snap ring

Bore diameter 10 – 130 mm

Extra-small ball bearings and miniature ball bearings



Bore diameter 1 – 9 mm



Flanged type

Bore diameter 1 – 9 mm

Double-row deep groove ball bearings



(with filling slot)

Bore diameter 10 – 75 mm

Table 1 Comparison of shielded and sealed bearing performance

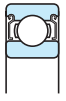
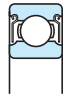
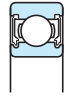
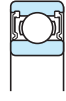
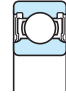
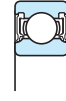
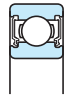
Type	Shielded		Sealed				
	Non-contact type		Non-contact type	Contact type		Extremely light contact type	
	ZZ type	2RU type	2RS type	2RK type	2RD type		
Characteristics	 (a) ¹⁾	 (b)	 (c)	 (d) ²⁾	 (e)	 (f)	 (g)
Friction torque	Small	Small	Large	Large	Small		
High speed performance	Good	Good	Limited because of contact		Good		
Grease sealing property	Good	Better than ZZ type	Better than 2RU type for low-speed applications	Excellent	Excellent		
Dirt resistance	Good	Better than ZZ type	Better than 2RU type	Excellent	Excellent		
Water resistance	Economical	Better than ZZ type but inferior to 2RS, 2RK and 2RD types	Good	Excellent	Better than ZZ and 2RU types		
Operating temperature ³⁾	- 30 to +110°C		- 30 to +100°C		- 30 to +110°C		

[Notes] 1) Illustration (a) of the ZZ type shows the relatively small size bearing.
 2) Illustration (d) of the 2RS type shows the relatively small size bearing.
 3) The operating temperature range listed is for the standard type. It can be widened by using a different type of grease or sealing material. Consult with JTEKT for details.

■ Handling instructions

- 1) The shielded/sealed type deep groove ball bearing and the deep groove ball bearing with a locating snap ring are designed for use with the inner ring rotating. Consult with JTEKT on use with the outer ring rotating.
- 2) When the axial load is large, make the shaft shoulder and housing shoulder larger than usual. (Referring to the specification table, make the mounting dimension d_a larger and make D_a smaller.)

Boundary dimensions	The dimensions of standard series are as specified in JIS B 1512. For extra-small and miniature ball bearings, special series (ML) are specified together with those described above.																																																																			
Tolerances	As specified in JIS B 1514-1. (refer to Table 7-3 on pp. A 54 – A 57.)																																																																			
Radial internal clearance	<ul style="list-style-type: none"> ■ Deep groove ball bearings (except extra-small ball bearings and miniature ball bearings) as specified in JIS B 1520 (refer to Table 10-2 on p. A 96.) ■ Extra-small ball bearings and miniature ball bearings (refer to Table 10-3 on p. A 96.) ■ Deep groove ball bearings for motors (refer to Table 10-7 on p. A 99.) 																																																																			
Recommended fits	<ul style="list-style-type: none"> ■ Bearings of classes 0 and 6 (refer to Table 9-4 on pp. A 85, 86.) ■ Precision extra-small ball bearings and miniature ball bearings (refer to Table 9-5 on p. A 87.) 																																																																			
Standard cages	<ul style="list-style-type: none"> ● Polyamide molded cage (supplementary code : FG, MG) ● Pressed steel cage (supplementary code : //) ● Copper alloy machined cage (supplementary code : FY) <p>[Remark] For certain applications, stainless steel sheet pressed cages (YS) may also be used.</p>	<table border="1"> <thead> <tr> <th colspan="4">Application of standard cages</th> </tr> <tr> <th>Bearing series</th> <th>Molded cage</th> <th>Pressed cage</th> <th>Machined cage</th> </tr> </thead> <tbody> <tr> <td>68</td> <td>683 – 689</td> <td>-</td> <td>-</td> </tr> <tr> <td>69</td> <td>693 – 699</td> <td>-</td> <td>-</td> </tr> <tr> <td>60</td> <td>603 – 609</td> <td>-</td> <td>-</td> </tr> <tr> <td>62</td> <td>623 – 629</td> <td>-</td> <td>-</td> </tr> <tr> <td>63</td> <td>633 – 639</td> <td>-</td> <td>-</td> </tr> <tr> <td>68</td> <td>-</td> <td>6800 – 6838</td> <td>6840 – 68/600</td> </tr> <tr> <td>69</td> <td>-</td> <td>6900 – 6918</td> <td>6920 – 6980</td> </tr> <tr> <td>160</td> <td>-</td> <td>16001 – 16028</td> <td>16030 – 16072</td> </tr> <tr> <td>60</td> <td>6000 – 6009</td> <td>6010 – 6034</td> <td>6036 – 6084</td> </tr> <tr> <td>62</td> <td>6200 – 6208</td> <td>6209 – 6230</td> <td>6232 – 6248</td> </tr> <tr> <td>63</td> <td>6300 – 6306</td> <td>6307 – 6328</td> <td>6330 – 6340</td> </tr> <tr> <td>64</td> <td>-</td> <td>6403 – 6418</td> <td>-</td> </tr> <tr> <td>42</td> <td>-</td> <td>4200 – 4215</td> <td>-</td> </tr> <tr> <td>43</td> <td>-</td> <td>4302 – 4315</td> <td>-</td> </tr> </tbody> </table>			Application of standard cages				Bearing series	Molded cage	Pressed cage	Machined cage	68	683 – 689	-	-	69	693 – 699	-	-	60	603 – 609	-	-	62	623 – 629	-	-	63	633 – 639	-	-	68	-	6800 – 6838	6840 – 68/600	69	-	6900 – 6918	6920 – 6980	160	-	16001 – 16028	16030 – 16072	60	6000 – 6009	6010 – 6034	6036 – 6084	62	6200 – 6208	6209 – 6230	6232 – 6248	63	6300 – 6306	6307 – 6328	6330 – 6340	64	-	6403 – 6418	-	42	-	4200 – 4215	-	43	-	4302 – 4315	-
Application of standard cages																																																																				
Bearing series	Molded cage	Pressed cage	Machined cage																																																																	
68	683 – 689	-	-																																																																	
69	693 – 699	-	-																																																																	
60	603 – 609	-	-																																																																	
62	623 – 629	-	-																																																																	
63	633 – 639	-	-																																																																	
68	-	6800 – 6838	6840 – 68/600																																																																	
69	-	6900 – 6918	6920 – 6980																																																																	
160	-	16001 – 16028	16030 – 16072																																																																	
60	6000 – 6009	6010 – 6034	6036 – 6084																																																																	
62	6200 – 6208	6209 – 6230	6232 – 6248																																																																	
63	6300 – 6306	6307 – 6328	6330 – 6340																																																																	
64	-	6403 – 6418	-																																																																	
42	-	4200 – 4215	-																																																																	
43	-	4302 – 4315	-																																																																	
Allowable misalignment	0.002 3 – 0.003 4 rad (8' – 12')																																																																			
Equivalent radial load (Single/double-row)	<p>Dynamic equivalent radial load</p> $P_r = XF_r + YF_a$ <p>(refer to the table on the right for values X and Y.)</p> <p>Static equivalent radial load</p> $P_{0r} = 0.6F_r + 0.5F_a$ <p>(when the value of $P_{0r} < F_r$, $P_{0r} = F_r$)</p>	<table border="1"> <thead> <tr> <th rowspan="2">$\frac{if_0F_a}{C_{0r}}$</th> <th rowspan="2">e</th> <th colspan="2">$\frac{F_a}{F_r} \leq e$</th> <th colspan="2">$\frac{F_a}{F_r} > e$</th> </tr> <tr> <th>X</th> <th>Y</th> <th>X</th> <th>Y</th> </tr> </thead> <tbody> <tr> <td>0.172</td> <td>0.19</td> <td rowspan="3">1</td> <td rowspan="3">0</td> <td rowspan="3">0.56</td> <td>2.30</td> </tr> <tr> <td>0.345</td> <td>0.22</td> <td>1.99</td> </tr> <tr> <td>0.689</td> <td>0.26</td> <td>1.71</td> </tr> <tr> <td>1.03</td> <td>0.28</td> <td rowspan="4">0.56</td> <td rowspan="4">0</td> <td rowspan="4">0.56</td> <td>1.55</td> </tr> <tr> <td>1.38</td> <td>0.30</td> <td>1.45</td> </tr> <tr> <td>2.07</td> <td>0.34</td> <td>1.31</td> </tr> <tr> <td>3.45</td> <td>0.38</td> <td>1.15</td> </tr> <tr> <td>5.17</td> <td>0.42</td> <td rowspan="2">0.44</td> <td rowspan="2">0</td> <td rowspan="2">0.44</td> <td>1.04</td> </tr> <tr> <td>6.89</td> <td>0.44</td> <td>1.00</td> </tr> </tbody> </table>	$\frac{if_0F_a}{C_{0r}}$	e	$\frac{F_a}{F_r} \leq e$		$\frac{F_a}{F_r} > e$		X	Y	X	Y	0.172	0.19	1	0	0.56	2.30	0.345	0.22	1.99	0.689	0.26	1.71	1.03	0.28	0.56	0	0.56	1.55	1.38	0.30	1.45	2.07	0.34	1.31	3.45	0.38	1.15	5.17	0.42	0.44	0	0.44	1.04	6.89	0.44	1.00																				
$\frac{if_0F_a}{C_{0r}}$	e	$\frac{F_a}{F_r} \leq e$			$\frac{F_a}{F_r} > e$																																																															
		X	Y	X	Y																																																															
0.172	0.19	1	0	0.56	2.30																																																															
0.345	0.22				1.99																																																															
0.689	0.26				1.71																																																															
1.03	0.28	0.56	0	0.56	1.55																																																															
1.38	0.30				1.45																																																															
2.07	0.34				1.31																																																															
3.45	0.38				1.15																																																															
5.17	0.42	0.44	0	0.44	1.04																																																															
6.89	0.44				1.00																																																															
	Factor f_0 is shown in the bearing dimension table.																																																																			

Single-row deep groove ball bearings
open type

d 10 ~ (20) mm

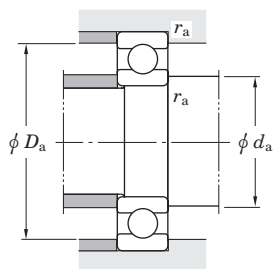
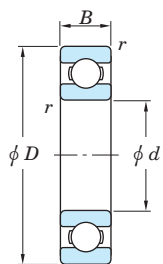

d (20) ~ (30) mm

Boundary dimensions (mm)				Basic load ratings (kN)		Factor f_0	Limiting speeds (min^{-1})		Bearing No.	Mounting dimensions (mm)			(Refer.) Mass (kg)
d	D	B	r_{min}	C_r	C_{0r}		Grease lub.	Oil lub.		d_a min.	D_a max.	r_a max.	
10	19	5	0.3	1.70	0.84	14.8	37 000	43 000	6800	12	17	0.3	0.005
	22	6	0.3	2.70	1.25	14.0	34 000	41 000	6900	12	20	0.3	0.010
	26	8	0.3	4.55	1.95	12.3	31 000	36 000	6000	12	24	0.3	0.019
	30	9	0.6	5.10	2.40	13.2	24 000	29 000	6200	14	26	0.6	0.032
	35	11	0.6	8.10	3.45	11.2	22 000	27 000	6300	14	31	0.6	0.053
12	21	5	0.3	1.90	1.05	15.3	33 000	39 000	6801	14	19	0.3	0.006
	24	6	0.3	2.90	1.45	14.5	31 000	36 000	6901	14	22	0.3	0.011
	28	7	0.3	5.10	2.40	13.2	27 000	32 000	16001	14	26	0.3	0.024
	28	8	0.3	5.10	2.40	13.2	27 000	32 000	6001	14	26	0.3	0.022
	32	10	0.6	6.80	3.05	12.3	22 000	27 000	6201	16	28	0.6	0.037
	37	12	1	9.70	4.20	11.1	20 000	25 000	6301	17	32	1	0.060
15	24	5	0.3	2.10	1.25	15.8	28 000	33 000	6802	17	22	0.3	0.007
	28	7	0.3	4.30	2.25	14.3	26 000	30 000	6902	17	26	0.3	0.017
	32	8	0.3	5.60	2.85	13.9	23 000	28 000	16002	17	30	0.3	0.025
	32	9	0.3	5.60	2.85	13.9	23 000	27 000	6002	17	30	0.3	0.030
	35	11	0.6	7.65	3.75	13.2	20 000	24 000	6202	19	31	0.6	0.045
	42	13	1	11.4	5.45	12.3	17 000	20 000	6302	20	37	1	0.082
17	26	5	0.3	2.60	1.55	15.7	26 000	30 000	6803	19	24	0.3	0.008
	30	7	0.3	4.60	2.55	14.7	23 000	28 000	6903	19	28	0.3	0.018
	35	8	0.3	6.00	3.25	14.4	21 000	25 000	16003	19	33	0.3	0.032
	35	10	0.3	6.00	3.25	14.4	21 000	25 000	6003	19	33	0.3	0.039
	40	12	0.6	9.55	4.80	13.2	17 000	21 000	6203	21	36	0.6	0.065
	47	14	1	13.6	6.65	12.4	15 000	18 000	6303	22	42	1	0.115
	47	14	1	15.6	7.60	12.0	15 000	18 000	6303R	22	42	1	0.121
	62	17	1.1	20.7	9.85	11.6	13 000	15 000	6403	23.5	55.5	1	0.270
20	32	7	0.3	4.00	2.45	15.5	21 000	25 000	6804	22	30	0.3	0.018
	37	9	0.3	6.35	3.70	14.7	19 000	23 000	6904	22	35	0.3	0.036
	42	8	0.3	7.95	4.50	14.4	17 000	21 000	16004	22	40	0.3	0.050

[Remark] Standard cage types used for the above bearings are described earlier in this section.

Boundary dimensions (mm)				Basic load ratings (kN)		Factor f_0	Limiting speeds (min^{-1})		Bearing No.	Mounting dimensions (mm)			(Refer.) Mass (kg)
d	D	B	r_{min}	C_r	C_{0r}		Grease lub.	Oil lub.		d_a min.	D_a max.	r_a max.	
20	42	12	0.6	9.40	5.05	13.9	17 000	21 000	6004	24	38	0.6	0.069
	42	12	0.6	11.5	5.85	13.0	18 000	21 000	6004R	24	38	0.6	0.073
	47	14	1	12.8	6.65	13.2	15 000	17 000	6204	25	42	1	0.106
	47	14	1	15.6	7.60	12.0	15 000	18 000	6204R	25	42	1	0.114
	52	15	1.1	15.9	7.85	12.3	14 000	17 000	6304	26.5	45.5	1	0.144
	52	15	1.1	18.1	8.95	12.0	14 000	16 000	6304R	26.5	45.5	1	0.151
	72	19	1.1	31.0	15.2	11.1	11 000	13 000	6404	26.5	65.5	1	0.400
	22	44	12	0.6	9.40	5.15	14.1	17 000	20 000	60/22	26	40	0.6
50		14	1	12.8	6.65	13.2	15 000	17 000	62/22	27	45	1	0.118
56		16	1.1	18.5	9.40	12.6	13 000	15 000	63/22	28.5	49.5	1	0.201
25	37	7	0.3	4.30	2.95	16.0	18 000	21 000	6805	27	35	0.3	0.022
	42	9	0.3	7.00	4.55	15.4	16 000	19 000	6905	27	40	0.3	0.041
	47	8	0.3	8.85	5.60	15.1	15 000	18 000	16005	27	45	0.3	0.060
	47	12	0.6	10.1	5.85	14.5	15 000	18 000	6005	29	43	0.6	0.080
	52	15	1	14.0	7.85	13.9	13 000	15 000	6205	30	47	1	0.128
	52	15	1	17.6	9.30	12.8	13 000	16 000	6205R	30	47	1	0.138
	62	17	1.1	20.6	11.3	13.2	11 000	13 000	6305	31.5	55.5	1	0.232
	62	17	1.1	26.2	13.4	11.9	11 000	14 000	6305R	31.5	55.5	1	0.255
80	21	1.5	36.1	19.4	12.2	9 100	11 000	6405	33	72	1.5	0.530	
28	52	12	0.6	12.4	7.40	14.5	14 000	16 000	60/28	32	48	0.6	0.097
	58	16	1	17.9	9.75	13.4	12 000	14 000	62/28	33	53	1	0.173
	68	18	1.1	23.5	13.1	13.3	10 000	12 000	63/28	34.5	61.5	1	0.328
30	42	7	0.3	4.55	3.40	16.4	15 000	18 000	6806	32	40	0.3	0.026
	47	9	0.3	7.25	5.00	15.8	14 000	17 000	6906	32	45	0.3	0.045
	55	9	0.3	11.2	7.35	15.2	13 000	15 000	16006	32	53	0.3	0.085
	55	13	1	13.2	8.25	14.7	13 000	15 000	6006	35	50	1	0.116
	62	16	1	19.5	11.3	13.9	11 000	13 000	6206	35	57	1	0.199
	62	16	1	23.4	12.8	13.0	11 000	13 000	6206R	35	57	1	0.212

Single-row deep groove ball bearings
open type

d (30) ~ (45) mm

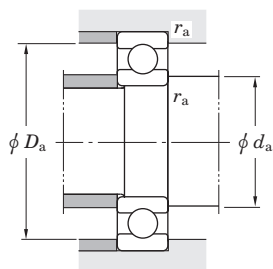
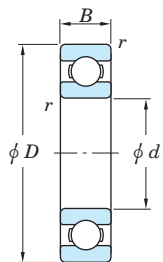

d (45) ~ (65) mm

Boundary dimensions (mm)				Basic load ratings (kN)		Factor f_0	Limiting speeds (min^{-1})		Bearing No.	Mounting dimensions (mm)			(Refer.) Mass (kg)
d	D	B	r_{min}	C_r	C_{0r}		Grease lub.	Oil lub.		d_a min.	D_a max.	r_a max.	
30	72	19	1.1	26.7	15.0	13.3	9 600	12 000	6306	36.5	65.5	1	0.346
	72	19	1.1	33.4	17.7	12.0	9 800	12 000	6306R	36.5	65.5	1	0.379
	90	23	1.5	43.4	23.9	12.3	8 100	9 700	6406	38	82	1.5	0.735
32	58	13	1	15.0	9.15	14.5	12 000	14 000	60/32	37	53	1	0.127
	65	17	1	23.5	13.1	13.3	10 000	12 000	62/32	37	60	1	0.228
	75	20	1.1	30.1	16.2	12.7	9 300	11 000	63/32	38.5	68.5	1	0.437
35	47	7	0.3	4.75	3.85	16.5	13 000	16 000	6807	37	45	0.3	0.030
	55	10	0.6	10.9	7.75	15.7	12 000	14 000	6907	39	51	0.6	0.073
	62	9	0.3	12.2	8.85	15.7	11 000	13 000	16007	37	60	0.3	0.110
	62	14	1	15.9	10.3	14.9	11 000	13 000	6007	40	58	1	0.155
	72	17	1.1	25.7	15.4	13.9	9 200	11 000	6207	41.5	65.5	1	0.288
	72	17	1.1	31.0	17.5	12.9	9 300	11 000	6207R	41.5	65.5	1	0.309
	80	21	1.5	33.4	19.3	13.2	8 500	10 000	6307	43	72	1.5	0.457
	80	21	1.5	40.0	21.7	12.1	8 700	10 000	6307R	43	72	1.5	0.494
	100	25	1.5	55.0	31.0	12.2	7 200	8 600	6407	43	92	1.5	0.952
	40	52	7	0.3	4.95	4.20	16.3	12 000	14 000	6808	42	50	0.3
62		12	0.6	13.7	9.95	15.6	11 000	13 000	6908	44	58	0.6	0.112
68		9	0.3	12.6	9.65	16.0	9 800	12 000	16008	42	66	0.3	0.125
68		15	1	16.7	11.5	15.2	10 000	12 000	6008	45	63	1	0.192
80		18	1.1	29.1	17.8	14.0	8 300	10 000	6208	46.5	73.5	1	0.366
90		23	1.5	40.7	24.0	13.2	7 700	9 200	6308	48	82	1.5	0.633
110		27	2	63.7	36.6	12.3	6 600	7 900	6408	49	101	2	1.23
45		58	7	0.3	6.20	5.40	16.3	11 000	13 000	6809	47	56	0.3
	68	12	0.6	14.1	10.9	15.9	9 700	11 000	6909	49	64	0.6	0.132
	75	10	0.6	15.5	12.3	16.0	8 900	10 000	16009	49	71	0.6	0.170
	75	16	1	21.0	15.1	15.3	9 200	11 000	6009	50	70	1	0.245
	85	19	1.1	32.7	20.3	14.0	7 700	9 200	6209	51.5	78.5	1	0.407
	100	25	1.5	48.9	29.5	13.3	6 800	8 100	6309	53	92	1.5	0.833

[Remark] Standard cage types used for the above bearings are described earlier in this section.

Boundary dimensions (mm)				Basic load ratings (kN)		Factor f_0	Limiting speeds (min^{-1})		Bearing No.	Mounting dimensions (mm)			(Refer.) Mass (kg)
d	D	B	r_{min}	C_r	C_{0r}		Grease lub.	Oil lub.		d_a min.	D_a max.	r_a max.	
45	120	29	2	77.2	45.1	12.2	6 000	7 200	6409	54	111	2	1.53
50	65	7	0.3	6.60	6.10	16.1	9 600	11 000	6810	52	63	0.3	0.052
	72	12	0.6	14.5	11.7	16.1	9 000	11 000	6910	54	68	0.6	0.133
	80	10	0.6	16.0	13.3	16.2	8 200	9 700	16010	54	76	0.6	0.180
	80	16	1	21.8	16.6	15.6	8 400	9 900	6010	55	75	1	0.261
	90	20	1.1	35.1	23.3	14.4	7 100	8 500	6210	56.5	83.5	1	0.463
	90	20	1.1	40.4	25.5	13.9	7 100	8 600	6210R	56.5	83.5	1	0.487
	110	27	2	62.0	38.3	13.2	6 100	7 300	6310	59	101	2	1.07
130	31	2.1	83.0	49.5	12.5	5 500	6 600	6410	61	119	2	1.88	
55	72	9	0.3	8.80	8.10	16.2	8 700	10 000	6811	57	70	0.3	0.083
	80	13	1	16.6	14.1	16.2	8 100	9 600	6911	60	75	1	0.185
	90	11	0.6	19.3	16.3	16.2	7 400	8 800	16011	59	86	0.6	0.260
	90	18	1.1	28.3	21.2	15.3	7 600	8 900	6011	61.5	83.5	1	0.385
	100	21	1.5	43.4	29.4	14.4	6 300	7 600	6211	63	92	1.5	0.607
	120	29	2	71.6	45.0	13.2	5 600	6 700	6311	64	111	2	1.37
140	33	2.1	100	62.3	12.2	5 000	6 000	6411	66	129	2	2.29	
60	78	10	0.3	11.5	10.6	16.3	8 000	9 400	6812	62	76	0.3	0.104
	85	13	1	20.2	17.3	16.2	7 500	8 900	6912	65	80	1	0.192
	95	11	0.6	19.8	17.6	16.4	6 900	8 100	16012	64	91	0.6	0.280
	95	18	1.1	29.4	23.2	15.6	7 100	8 400	6012	66.5	88.5	1	0.415
	110	22	1.5	52.4	36.2	14.4	5 700	6 900	6212	68	102	1.5	0.783
	130	31	2.1	81.9	52.2	13.2	5 200	6 200	6312	71	119	2	1.70
150	35	2.1	110	70.8	12.4	4 600	5 500	6412	71	139	2	2.77	
65	85	10	0.6	11.9	11.5	16.2	7 300	8 600	6813	69	81	0.6	0.126
	90	13	1	17.4	16.1	16.6	7 100	8 400	6913	70	85	1	0.211
	100	11	0.6	17.1	16.0	16.5	6 600	7 800	16013	69	96	0.6	0.300
	100	18	1.1	30.5	25.2	15.8	6 600	7 800	6013	71.5	93.5	1	0.435

Single-row deep groove ball bearings
open type

d (65) ~ (85) mm

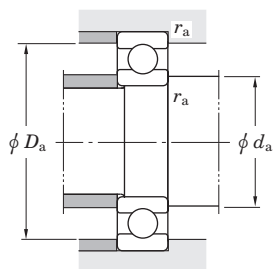
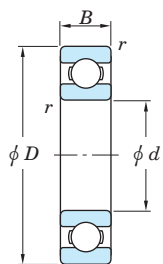

d (85) ~ 105 mm

Boundary dimensions (mm)				Basic load ratings (kN)		Factor f_0	Limiting speeds (min^{-1})		Bearing No.	Mounting dimensions (mm)			(Refer.) Mass (kg)
d	D	B	r_{min}	C_r	C_{0r}		Grease lub.	Oil lub.		d_a min.	D_a max.	r_a max.	
65	120	23	1.5	57.2	40.1	14.4	5 400	6 400	6213	73	112	1.5	0.990
	140	33	2.1	92.7	59.9	13.2	4 800	5 800	6313	76	129	2	2.08
	160	37	2.1	118	79.2	12.4	4 300	5 200	6413	76	149	2	3.30
70	90	10	0.6	12.1	11.9	16.1	6 800	8 100	6814	74	86	0.6	0.134
	100	16	1	23.7	21.2	16.3	6 400	7 600	6914	75	95	1	0.342
	110	13	0.6	30.1	25.6	16.0	6 100	7 200	16014	74	106	0.6	0.433
	110	20	1.1	38.1	30.9	15.6	6 100	7 200	6014	76.5	103.5	1	0.602
	125	24	1.5	62.2	44.1	14.5	5 100	6 100	6214	78	117	1.5	1.07
	150	35	2.1	104	68.2	13.2	4 500	5 400	6314	81	139	2	2.52
	180	42	3	144	104	12.2	3 900	4 600	6414	83	167	2.5	4.83
75	95	10	0.6	12.5	12.9	16.0	6 400	7 600	6815	79	91	0.6	0.142
	105	16	1	24.4	22.6	16.5	6 100	7 200	6915	80	100	1	0.363
	115	13	0.6	27.5	25.3	16.4	5 700	6 700	16015	79	111	0.6	0.457
	115	20	1.1	39.6	33.5	15.8	5 700	6 800	6015	81.5	108.5	1	0.638
	130	25	1.5	67.4	48.3	14.5	4 800	5 800	6215	83	122	1.5	1.18
	160	37	2.1	113	77.2	13.2	4 200	5 000	6315	86	149	2	3.02
	190	45	3	154	115	12.3	3 600	4 400	6415	88	177	2.5	5.87
	80	100	10	0.6	12.7	13.3	16.0	6 100	7 200	6816	84	96	0.6
110		16	1	25.0	24.0	16.6	5 700	6 800	6916	85	105	1	0.382
125		14	0.6	31.7	29.7	16.4	5 200	6 100	16016	84	121	0.6	0.597
125		22	1.1	47.6	39.8	15.6	5 300	6 300	6016	86.5	118.5	1	0.850
140		26	2	72.7	53.0	14.6	4 500	5 400	6216	89	131	2	1.40
170		39	2.1	123	86.7	13.3	3 900	4 700	6316	91	159	2	3.59
200		48	3	164	125	12.3	3 400	4 100	6416	93	187	2.5	6.84
85	110	13	1	18.7	19.0	16.2	5 600	6 600	6817	90	105	1	0.266
	120	18	1.1	31.9	29.6	16.4	5 300	6 300	6917	91.5	113.5	1	0.535
	130	14	0.6	32.6	31.7	16.5	4 900	5 800	16017	89	126	0.6	0.626

[Remark] Standard cage types used for the above bearings are described earlier in this section.

Boundary dimensions (mm)				Basic load ratings (kN)		Factor f_0	Limiting speeds (min^{-1})		Bearing No.	Mounting dimensions (mm)			(Refer.) Mass (kg)
d	D	B	r_{min}	C_r	C_{0r}		Grease lub.	Oil lub.		d_a min.	D_a max.	r_a max.	
85	130	22	1.1	49.5	43.1	15.8	5 000	5 900	6017	91.5	123.5	1	0.890
	150	28	2	84.0	61.9	14.5	4 200	5 000	6217	94	141	2	1.79
	180	41	3	133	96.8	13.3	3 700	4 400	6317	98	167	2.5	4.23
	210	52	4	173	136	12.3	3 300	3 900	6417	101	194	3	8.07
90	115	13	1	19.0	19.7	16.1	5 300	6 300	6818	95	110	1	0.279
	125	18	1.1	32.8	31.6	16.5	5 100	6 000	6918	96.5	118.5	1	0.565
	140	16	1	39.9	37.0	16.3	4 700	5 600	16018	95	135	1	0.848
	140	24	1.5	58.2	49.7	15.6	4 700	5 600	6018	98	132	1.5	1.16
	160	30	2	96.1	71.5	14.5	3 900	4 700	6218	99	151	2	2.15
	190	43	3	143	107	13.3	3 500	4 200	6318	103	177	2.5	4.91
	225	54	4	184	149	12.5	3 100	3 700	6418	106	209	3	9.78
95	130	18	1.1	33.7	33.5	16.6	4 800	5 700	6919	101.5	123.5	1	0.705
	145	16	1	41.2	39.6	16.4	4 500	5 300	16019	100	140	1	0.885
	145	24	1.5	60.4	53.9	15.8	4 400	5 200	6019	103	137	1.5	1.21
	170	32	2.1	109	81.9	14.4	3 700	4 400	6219	106	159	2	2.62
	200	45	3	153	119	13.3	3 300	4 000	6319	108	187	2.5	5.67
100	125	13	1	19.6	21.2	16.0	4 800	5 700	6820	105	120	1	0.309
	140	20	1.1	45.0	41.9	16.2	4 500	5 300	6920	106.5	133.5	1	0.960
	150	16	1	42.4	42.1	16.5	4 300	5 100	16020	105	145	1	0.910
	150	24	1.5	60.2	54.2	15.9	4 300	5 100	6020	108	142	1.5	1.25
	180	34	2.1	122	93.1	14.4	3 500	4 200	6220	111	169	2	3.14
	215	47	3	173	141	13.2	3 000	3 600	6320	113	202	2.5	7.00
	105	145	20	1.1	46.5	44.8	16.4	4 300	5 100	6921	111.5	138.5	1
160		18	1	41.9	42.2	16.5	4 100	4 800	16021	110	155	1	1.20
160		26	2	72.3	65.8	15.8	4 000	4 700	6021	114	151	2	1.59
190		36	2.1	133	105	14.4	3 300	3 900	6221	116	179	2	3.70
225		49	3	184	153	13.2	2 900	3 500	6321	118	212	2.5	8.05

Single-row deep groove ball bearings
open type

d 110 ~ (150) mm

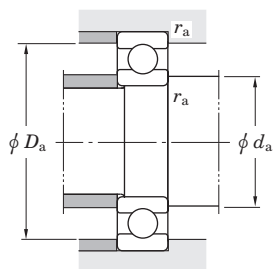
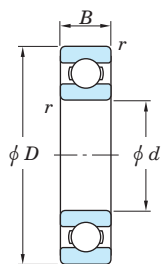

d (150) ~ (200) mm

Boundary dimensions (mm)				Basic load ratings (kN)		Factor f_0	Limiting speeds (min^{-1})		Bearing No.	Mounting dimensions (mm)			(Refer.) Mass (kg)
d	D	B	r_{min}	C_r	C_{0r}		Grease lub.	Oil lub.		d_a min.	D_a max.	r_a max.	
110	140	16	1	28.1	30.7	16.1	4 300	5 100	6822	115	135	1	0.606
	150	20	1.1	47.9	47.8	16.4	4 100	4 900	6922	116.5	143.5	1	1.04
	170	19	1	57.5	56.7	16.3	3 800	4 500	16022	115	165	1	1.46
	170	28	2	82.0	73.0	15.6	3 800	4 500	6022	119	161	2	1.96
	200	38	2.1	144	117	14.4	3 100	3 700	6222	121	189	2	4.36
	240	50	3	205	180	13.2	2 700	3 200	6322	123	227	2.5	9.54
120	150	16	1	29.0	33.0	16.0	4 000	4 700	6824	125	145	1	0.655
	165	22	1.1	57.2	56.9	16.4	3 800	4 400	6924	126.5	158.5	1	1.41
	180	19	1	63.2	63.3	16.4	3 600	4 200	16024	125	175	1	1.80
	180	28	2	85.0	79.3	15.9	3 600	4 200	6024	129	171	2	2.07
	215	40	2.1	155	131	14.4	2 900	3 400	6224	131	204	2	5.15
	260	55	3	207	185	13.5	2 500	3 000	6324	133	247	2.5	12.5
130	165	18	1.1	36.9	41.2	16.1	3 600	4 300	6826	136.5	158.5	1	0.939
	180	24	1.5	65.2	67.4	16.3	3 400	4 100	6926	138	172	1.5	1.86
	200	22	1.1	71.3	74.8	11.2	3 000	3 600	16026	136.5	193.5	1	2.69
	200	33	2	106	101	15.8	3 200	3 800	6026	139	191	2	3.16
	230	40	3	167	146	14.5	2 700	3 200	6226	143	217	2.5	5.82
	280	58	4	229	214	13.6	2 300	2 700	6326	146	264	3	15.1
140	175	18	1.1	38.2	44.4	16.0	3 400	4 000	6828	146.5	168.5	1	1.00
	190	24	1.5	71.3	74.8	16.5	3 200	3 800	6928	148	182	1.5	1.98
	210	22	1.1	65.8	71.1	16.5	2 900	3 400	16028	146.5	203.5	1	2.86
	210	33	2	110	109	15.9	3 000	3 600	6028	149	201	2	3.55
	250	42	3	166	150	14.8	2 400	2 900	6228	153	237	2.5	7.45
	300	62	4	253	246	13.6	2 100	2 500	6328	156	284	3	19.4
150	190	20	1.1	47.8	54.9	16.1	3 100	3 700	6830	156.5	183.5	1	1.40
	210	28	2	93.4	94.3	16.2	2 900	3 400	6930	159	201	2	3.05
	225	24	1.1	91.2	99.3	16.6	2 700	3 100	16030	156.5	218.5	1	3.58
	225	35	2.1	125	126	16.0	2 800	3 300	6030	161	214	2	4.22

[Remark] Standard cage types used for the above bearings are described earlier in this section.

Boundary dimensions (mm)				Basic load ratings (kN)		Factor f_0	Limiting speeds (min^{-1})		Bearing No.	Mounting dimensions (mm)			(Refer.) Mass (kg)
d	D	B	r_{min}	C_r	C_{0r}		Grease lub.	Oil lub.		d_a min.	D_a max.	r_a max.	
150	270	45	3	176	168	15.1	2 200	2 700	6230	163	257	2.5	9.41
	320	65	4	275	284	13.9	1 900	2 300	6330	166	304	3	26.2
160	200	20	1.1	48.4	56.9	16.1	2 900	3 400	6832	166.5	193.5	1	1.45
	220	28	2	96.1	101	16.4	2 700	3 200	6932	169	211	2	3.20
	240	25	1.5	98.8	108	16.5	2 600	3 100	16032	168	232	1.5	4.25
	240	38	2.1	136	135	15.9	2 600	3 000	6032	171	229	2	5.22
	290	48	3	185	186	15.4	2 100	2 500	6232	173	277	2.5	14.3
	340	68	4	278	286	13.9	1 800	2 200	6332	176	324	3	29.0
170	215	22	1.1	59.8	70.5	16.1	2 700	3 200	6834	176.5	208.5	1	1.90
	230	28	2	98.8	108	16.5	2 600	3 100	6934	179	221	2	3.35
	260	28	1.5	114	127	16.5	2 300	2 700	16034	178	252	1.5	5.75
	260	42	2.1	161	161	15.8	2 400	2 800	6034	181	249	2	6.80
	310	52	4	212	223	15.3	1 900	2 300	6234	186	294	3	17.5
	360	72	4	326	355	13.6	1 700	2 000	6334	186	344	3	38.6
180	225	22	1.1	60.7	73.1	16.1	2 600	3 000	6836	186.5	218.5	1	2.00
	250	33	2	123	129	16.3	2 400	2 800	6936	189	241	2	4.90
	280	31	2	135	148	16.4	2 100	2 500	16036	189	271	2	7.55
	280	46	2.1	182	194	15.8	2 200	2 600	6036	191	269	2	10.3
	320	52	4	227	241	15.1	1 800	2 200	6236	196	304	3	18.3
	380	75	4	354	407	13.9	1 600	1 900	6336	196	364	3	44.7
190	240	24	1.5	73.1	88.1	16.1	2 400	2 800	6838	198	232	1.5	2.60
	260	33	2	126	138	16.4	2 300	2 700	6938	199	251	2	5.20
	290	31	2	139	158	16.6	2 000	2 400	16038	199	281	2	7.85
	290	46	2.1	188	201	15.8	2 100	2 500	6038	201	279	2	10.8
	340	55	4	255	281	15.0	1 700	2 000	6238	206	324	3	23.0
	400	78	5	355	415	14.1	1 500	1 800	6338	210	380	4	51.5
200	250	24	1.5	78.0	93.6	16.1	2 300	2 700	6840	208	242	1.5	2.70

Single-row deep groove ball bearings open type

d (200) ~ (280) mm

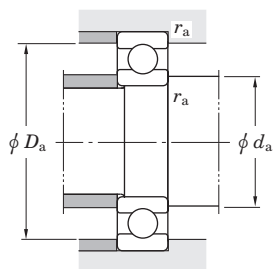
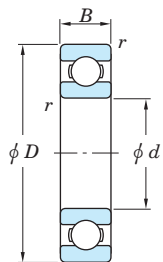

d (280) ~ (380) mm

Boundary dimensions (mm)	Basic load ratings (kN)		Factor f_0	Limiting speeds (min ⁻¹)		Bearing No.	Mounting dimensions (mm)			(Refer.) Mass (kg)			
	d	D		C_r	C_{0r}		Grease lub.	Oil lub.	d_a min.		D_a max.	r_a max.	
200	280	38	2.1	157	168	16.2	2 100	2 500	6940	211	269	2	7.30
	310	34	2	161	180	16.4	1 900	2 300	16040	209	301	2	10.1
	310	51	2.1	217	243	15.6	1 900	2 300	6040	211	299	2	14.0
	360	58	4	269	311	15.2	1 600	1 900	6240	216	344	3	28.2
	420	80	5	411	506	14.0	1 300	1 600	6340	220	400	4	58.0
220	270	24	1.5	80.7	101	16.0	2 000	2 400	6844	228	262	1.5	3.00
	300	38	2.1	160	180	16.4	1 900	2 200	6944	231	289	2	7.90
	340	37	2.1	180	217	16.5	1 700	2 000	16044	231	329	2	13.2
	340	56	3	235	271	15.6	1 700	2 000	6044	233	327	2.5	18.3
	400	65	4	311	376	15.1	1 400	1 700	6244	236	384	3	37.0
	460	88	5	433	539	13.8	1 200	1 500	6344	240	440	4	71.6
240	300	28	2	108	135	16.1	1 800	2 100	6848	249	291	2	4.50
	320	38	2.1	164	192	16.5	1 700	2 000	6948	251	309	2	8.50
	360	37	2.1	184	228	16.5	1 600	1 800	16048	251	349	2	14.1
	360	56	3	244	296	15.9	1 600	1 900	6048	253	347	2.5	19.7
	440	72	4	340	431	15.2	1 200	1 500	6248	256	424	3	51.0
	500	95	5	470	624	14.2	1 100	1 300	6348	260	480	4	93.3
260	320	28	2	112	146	16.0	1 700	2 000	6852	269	311	2	4.80
	360	46	2.1	213	263	16.3	1 500	1 800	6952	271	349	2	14.4
	400	44	3	236	310	16.4	1 400	1 600	16052	273	387	2.5	21.6
	400	65	4	291	377	15.8	1 400	1 700	6052	276	384	3	29.3
	480	80	5	402	541	15.1	1 100	1 300	6252	280	460	4	68.2
	540	102	6	531	741	14.2	990	1 200	6352	284	516	5	116
280	350	33	2	143	183	16.1	1 500	1 800	6856	289	341	2	7.40
	380	46	2.1	219	283	16.5	1 400	1 700	6956	291	369	2	15.1
	420	44	3	242	331	14.7	1 300	1 500	16056	293	407	2.5	22.9
	420	65	4	302	408	16.0	1 300	1 500	6056	296	404	3	31.0
	500	80	5	423	599	15.3	1 000	1 200	6256	300	480	4	71.8

[Remark] Standard cage types used for the above bearings are described earlier in this section.

Boundary dimensions (mm)	Basic load ratings (kN)		Factor f_0	Limiting speeds (min ⁻¹)		Bearing No.	Mounting dimensions (mm)			(Refer.) Mass (kg)			
	d	D		C_r	C_{0r}		Grease lub.	Oil lub.	d_a min.		D_a max.	r_a max.	
280	580	108	6	568	845	14.5	880	1 100	6356	304	556	5	145
300	380	38	2.1	179	230	16.2	1 400	1 600	6860	311	369	2	10.5
	420	56	3	276	377	16.2	1 300	1 500	6960	313	407	2.5	24.1
	460	50	4	284	405	16.4	1 100	1 400	16060	316	447	3	32.2
	460	74	4	355	482	15.6	1 200	1 400	6060	316	444	3	44.0
	540	85	5	441	663	15.6	880	1 100	6260	320	520	4	89.5
	620	109	7.5	593	886	14.4	810	970	6360	332	588	6	169
320	400	38	2.1	182	239	16.1	1 300	1 500	6864	331	389	2	11.0
	440	56	3	285	404	16.4	1 200	1 400	6964	333	427	2.5	25.5
	480	50	4	292	432	16.5	1 100	1 300	16064	336	467	3	33.9
	480	74	4	352	487	15.7	1 100	1 300	6064	336	464	3	46.0
	580	92	5	489	744	15.4	840	1 000	6264	340	560	4	113
	670	112	7.5	634	1 010	14.8	720	870	6364	352	638	6	207
340	420	38	2.1	185	249	16.1	1 200	1 400	6868	351	409	2	11.5
	460	56	3	282	407	16.5	1 100	1 300	6968	353	447	2.5	26.8
	520	57	4	335	512	16.4	980	1 200	16068	356	507	3	46.8
	520	82	5	441	661	15.6	980	1 200	6068	360	500	4	61.8
	620	92	6	511	817	15.6	760	910	6268	364	596	5	131
	710	118	7.5	704	1 160	14.7	660	790	6368	372	678	6	238
360	440	38	2.1	192	268	16.0	1 100	1 300	6872	371	429	2	12.0
	480	56	3	289	432	16.5	1 000	1 200	6972	373	467	2.5	28.2
	540	57	4	345	546	16.5	900	1 100	16072	376	527	3	49.0
	540	82	5	438	668	15.7	920	1 100	6072	380	520	4	64.7
	650	95	6	557	904	15.4	700	840	6272	384	626	5	144
	380	480	46	2.1	244	359	16.2	980	1 200	6876	391	469	2
520		65	4	352	552	16.4	920	1 100	6976	396	504	3	40.8
560		82	5	457	725	15.9	860	1 000	6076	400	540	4	67.6

Single-row deep groove ball bearings open type

d (380) ~ 500 mm

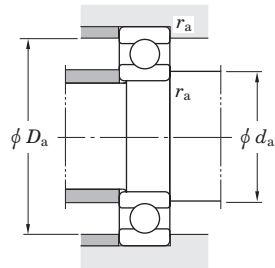
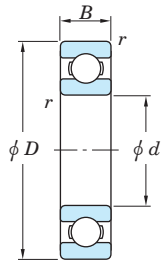

Boundary dimensions (mm)				Basic load ratings (kN)		Factor f_0	Limiting speeds (min^{-1})		Bearing No.	Mounting dimensions (mm)			(Refer.) Mass (kg)
d	D	B	r_{min}	C_r	C_{0r}		Grease lub.	Oil lub.		d_a min.	D_a max.	r_a max.	
380	680	95	6	584	990	15.6	650	780	6276	404	656	5	162
400	500	46	2.1	249	374	16.1	920	1 100	6880	411	489	2	20.5
	540	65	4	362	588	16.5	860	1 000	6980	416	524	3	42.7
	600	63	5	358	587	16.5	780	920	16080	420	580	4	65.0
	600	90	5	508	824	15.7	780	920	6080	420	580	4	87.7
420	720	103	6	628	1 080	15.5	590	710	6280	424	696	5	197
	520	46	2.1	253	389	16.1	860	1 000	6884	431	509	2	21.5
	560	65	4	359	588	16.5	810	950	6984	436	544	3	43.5
	620	63	5	367	617	16.4	740	870	16084	440	600	4	69.9
440	620	90	5	530	894	15.8	740	870	6084	440	600	4	91.2
	540	46	2.1	257	404	16.0	810	950	6888	451	529	2	22.5
	600	74	4	396	676	16.4	740	870	6988	456	584	3	61.3
	650	67	5	407	710	16.5	680	810	16088	460	630	4	81.7
460	580	56	3	314	517	16.2	740	870	6892	473	567	2.5	35.0
	620	74	4	407	711	16.5	690	820	6992	476	604	3	61.7
	680	71	5	431	767	16.5	630	750	16092	480	660	4	91.2
480	600	56	3	321	539	16.1	690	820	6896	493	587	2.5	36.5
	650	78	5	432	768	16.5	640	760	6996	500	630	4	72.5
	700	71	5	444	807	16.5	600	710	16096	500	680	4	98.5
500	620	56	3	327	561	16.1	650	770	68/500	513	607	2.5	37.5
	670	78	5	444	807	16.5	610	720	69/500	520	650	4	75.2
	720	71	5	455	846	16.4	560	660	160/500	520	700	4	102
	720	100	6	600	1 100	16.0	570	670	60/500	524	696	5	128

[Remark] Standard cage types used for the above bearings are described earlier in this section.

Single-row deep groove ball bearings
shielded type
sealed type

d 10 ~ (22) mm

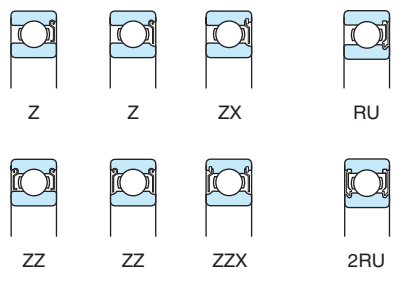
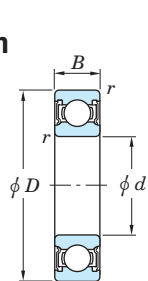

Shielded Non-contact sealed

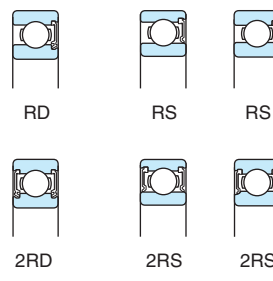

Extremely light contact sealed Contact sealed

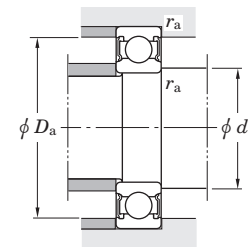

Boundary dimensions (mm)				Basic load ratings (kN)		Factor f_0	Limiting speeds (min^{-1})				Bearing No.				Mounting dimensions (mm)				(Refer.) Mass Open type (kg)
d	D	B	r min.	C_r	C_{0r}		Grease lub.		Oil lub.	Shielded	Non-contact sealed	Extremely light contact sealed	Contact sealed	d_a min.	d_a max.	D_a max.	r_a max.		
							{ Z, ZZ } { RU, 2RU }	(RD, 2RD)	(RS, 2RS)	(Z)									
10	19	5	0.3	1.70	0.84	14.8	37 000	—	22 000	43 000	6800 ZZ	6800 2RU	—	6800 2RS	12	12	17	0.3	0.005
	22	6	0.3	2.70	1.25	14.0	34 000	—	21 000	41 000	6900 ZZ	6900 2RU	—	6900 2RS	12	12.5	20	0.3	0.010
	26	8	0.3	4.55	1.95	12.3	31 000	28 000	19 000	36 000	6000 ZZ	6000 2RU	6000 2RD	6000 2RS	12	13	24	0.3	0.019
	30	9	0.6	5.10	2.40	13.2	24 000	22 000	16 000	29 000	6200 ZZ	6200 2RU	6200 2RD	6200 2RS	14	15	26	0.6	0.032
	35	11	0.6	8.10	3.45	11.2	22 000	20 000	16 000	27 000	6300 ZZ	6300 2RU	6300 2RD	6300 2RS	14	16	31	0.6	0.053
12	21	5	0.3	1.90	1.05	15.3	33 000	30 000	20 000	39 000	6801 ZZ	6801 2RU	6801 2RD	6801 2RS	14	14	19	0.3	0.006
	24	6	0.3	2.90	1.45	14.5	31 000	28 000	18 000	36 000	6901 ZZ	6901 2RU	6901 2RD	6901 2RS	14	14	22	0.3	0.011
	28	8	0.3	5.10	2.40	13.2	27 000	24 000	17 000	32 000	6001 ZZ	6001 2RU	6001 2RD	6001 2RS	14	15	26	0.3	0.022
	32	10	0.6	6.80	3.05	12.3	22 000	20 000	15 000	27 000	6201 ZZ	6201 2RU	6201 2RD	6201 2RS	16	16.5	28	0.6	0.037
	37	12	1	9.70	4.20	11.1	20 000	18 000	15 000	25 000	6301 ZZ	6301 2RU	6301 2RD	6301 2RS	17	17.5	32	1	0.060
15	24	5	0.3	2.10	1.25	15.8	28 000	—	16 000	33 000	6802 ZZ	6802 2RU	—	6802 2RS	17	17	22	0.3	0.007
	28	7	0.3	4.30	2.25	14.3	26 000	23 000	15 000	30 000	6902 ZZ	6902 2RU	6902 2RD	6902 2RS	17	18	26	0.3	0.017
	32	9	0.3	5.60	2.85	13.9	23 000	21 000	14 000	27 000	6002 ZZ	6002 2RU	6002 2RD	6002 2RS	17	18.5	30	0.3	0.030
	35	11	0.6	7.65	3.75	13.2	20 000	18 000	13 000	24 000	6202 ZZ	6202 2RU	6202 2RD	6202 2RS	19	19.5	31	0.6	0.045
	42	13	1	11.4	5.45	12.3	17 000	15 000	12 000	20 000	6302 ZZ	6302 2RU	6302 2RD	6302 2RS	20	21.5	37	1	0.082
17	26	5	0.3	2.60	1.55	15.7	26 000	—	14 000	30 000	6803 ZZ	6803 2RU	—	6803 2RS	19	19	24	0.3	0.008
	30	7	0.3	4.60	2.55	14.7	23 000	21 000	13 000	28 000	6903 ZZ	6903 2RU	6903 2RD	6903 2RS	19	19.5	28	0.3	0.018
	35	10	0.3	6.00	3.25	14.4	21 000	19 000	12 000	25 000	6003 ZZ	6003 2RU	6003 2RD	6003 2RS	19	21	33	0.3	0.039
	40	12	0.6	9.55	4.80	13.2	17 000	15 000	12 000	21 000	6203 ZZ	6203 2RU	6203 2RD	6203 2RS	21	22	36	0.6	0.065
	47	14	1	13.6	6.65	12.4	15 000	14 000	10 000	18 000	6303 ZZ	6303 2RU	6303 2RD	6303 2RS	22	24.3	42	1	0.115
20	32	7	0.3	4.00	2.45	15.5	21 000	—	12 000	25 000	6804 ZZ	6804 2RU	—	6804 2RS	22	22.5	30	0.3	0.018
	37	9	0.3	6.35	3.70	14.7	19 000	17 000	11 000	23 000	6904 ZZ	6904 2RU	6904 2RD	6904 2RS	22	23.5	35	0.3	0.036
	42	12	0.6	9.40	5.05	13.9	17 000	15 000	10 000	21 000	6004 ZZ	6004 2RU	6004 2RD	6004 2RS	24	25	38	0.6	0.069
	47	14	1	12.8	6.65	13.2	15 000	14 000	9 700	17 000	6204 ZZ	6204 2RU	6204 2RD	6204 2RS	25	26.5	42	1	0.106
	52	15	1.1	15.9	7.85	12.3	14 000	13 000	9 500	17 000	6304 ZZ	6304 2RU	6304 2RD	6304 2RS	26.5	27	45.5	1	0.144
22	44	12	0.6	9.40	5.15	14.1	17 000	15 000	9 900	20 000	60/22 ZZ	60/22 2RU	60/22 2RD	60/22 2RS	26	26.5	40	0.6	0.073
	50	14	1	12.8	6.65	13.2	15 000	14 000	9 700	17 000	62/22 ZZ	62/22 2RU	62/22 2RD	62/22 2RS	27	27	45	1	0.118

[Remark] Standard cage types used for the above bearings are described earlier in this section.

Single-row deep groove ball bearings
shielded type
sealed type

d (22) ~ 40 mm

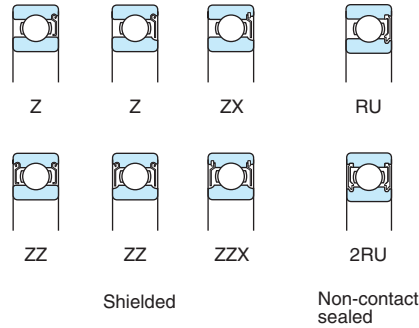
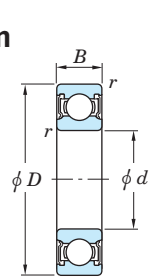

Shielded

Non-contact sealed

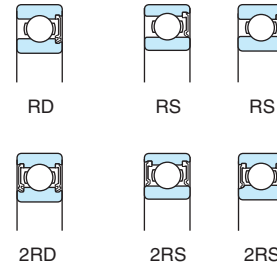

Extremely light contact sealed

Contact sealed

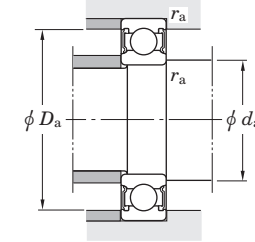

Boundary dimensions (mm)				Basic load ratings (kN)		Factor f_0	Limiting speeds (min^{-1})				Bearing No.				Mounting dimensions (mm)				(Refer.) Mass Open type (kg)		
d	D	B	r_{min}	C_r	C_{0r}		Grease lub.		Oil lub.		Shielded		Non-contact sealed		Extremely light contact sealed		Contact sealed			d_a min.	d_a max.
22	56	16	1.1	18.5	9.40	12.6	13 000	12 000	8 600	15 000	63/22 ZZ	63/22 2RU	63/22 2RD	63/22 2RS	28.5	29	49.5	1	0.201		
25	37	7	0.3	4.30	2.95	16.0	18 000	—	10 000	21 000	6805 ZZ	6805 2RU	—	6805 2RS	27	27.5	35	0.3	0.022		
	42	9	0.3	7.00	4.55	15.4	16 000	14 000	9 300	19 000	6905 ZZ	6905 2RU	6905 2RD	6905 2RS	27	29	40	0.3	0.041		
	47	12	0.6	10.1	5.85	14.5	15 000	14 000	9 000	18 000	6005 ZZ	6005 2RU	6005 2RD	6005 2RS	29	29.5	43	0.6	0.080		
	52	15	1	14.0	7.85	13.9	13 000	12 000	8 400	15 000	6205 ZZ	6205 2RU	6205 2RD	6205 2RS	30	31.5	47	1	0.128		
	62	17	1.1	20.6	11.3	13.2	11 000	9 900	7 500	13 000	6305 ZZ	6305 2RU	6305 2RD	6305 2RS	31.5	34	55.5	1	0.232		
28	52	12	0.6	12.4	7.40	14.5	14 000	13 000	8 100	16 000	60/28 ZZ	60/28 2RU	60/28 2RD	60/28 2RS1	32	33	48	0.6	0.097		
	58	16	1	17.9	9.75	13.4	12 000	11 000	7 600	14 000	62/28 ZZ	62/28 2RU	62/28 2RD	62/28 2RS	33	35	53	1	0.173		
	68	18	1.1	23.5	13.1	13.3	10 000	9 000	6 900	12 000	63/28 ZZ	63/28 2RU	63/28 2RD	63/28 2RS	34.5	37.5	61.5	1	0.328		
30	42	7	0.3	4.55	3.40	16.4	15 000	—	8 600	18 000	6806 ZZ	6806 2RU	—	6806 2RS	32	32.5	40	0.3	0.026		
	47	9	0.3	7.25	5.00	15.8	14 000	13 000	8 200	17 000	6906 ZZ	6906 2RU	6906 2RD	6906 2RS	32	33	45	0.3	0.045		
	55	13	1	13.2	8.25	14.7	13 000	12 000	7 500	15 000	6006 ZZ	6006 2RU	6006 2RD	6006 2RS	35	36	50	1	0.116		
	62	16	1	19.5	11.3	13.9	11 000	9 900	7 000	13 000	6206 ZZ	6206 2RU	6206 2RD	6206 2RS	35	37.5	57	1	0.199		
	72	19	1.1	26.7	15.0	13.3	9 600	8 600	6 400	12 000	6306 ZZ	6306 2RU	6306 2RD	6306 2RS	36.5	40	65.5	1	0.346		
32	58	13	1	15.0	9.15	14.5	12 000	11 000	7 200	14 000	60/32 ZZ	60/32 2RU	60/32 2RD	60/32 2RS	37	38	53	1	0.127		
	65	17	1	23.5	13.1	13.3	10 000	9 000	6 900	12 000	62/32 ZZ	62/32 2RU	62/32 2RD	62/32 2RS	37	38.5	60	1	0.228		
	75	20	1.1	30.1	16.2	12.7	9 300	8 400	6 400	11 000	63/32 ZZ	63/32 2RU	63/32 2RD	63/32 2RS	38.5	41	68.5	1	0.437		
35	47	7	0.3	4.75	3.85	16.5	13 000	—	7 400	16 000	6807 ZZ	6807 2RU	—	6807 2RS	37	37.5	45	0.3	0.030		
	55	10	0.6	10.9	7.75	15.7	12 000	11 000	6 800	14 000	6907 ZZ	6907 2RU	6907 2RD	6907 2RS	39	40	51	0.6	0.073		
	62	14	1	15.9	10.3	14.9	11 000	9 900	6 500	13 000	6007 ZZ	6007 2RU	6007 2RD	6007 2RS	40	42	58	1	0.155		
	72	17	1.1	25.7	15.4	13.9	9 200	8 300	6 000	11 000	6207 ZZ	6207 2RU	6207 2RD	6207 2RS	41.5	43.5	65.5	1	0.288		
	80	21	1.5	33.4	19.3	13.2	8 500	7 700	5 700	10 000	6307 ZZ	6307 2RU	6307 2RD	6307 2RS	43	46	72	1.5	0.457		
40	52	7	0.3	4.95	4.20	16.3	12 000	11 000	6 700	14 000	6808 ZZ	6808 2RU	6808 2RD	6808 2RS	42	42	50	0.3	0.033		
	62	12	0.6	13.7	9.95	15.6	11 000	9 900	6 100	13 000	6908 ZZ	6908 2RU	6908 2RD	6908 2RS	44	44.5	58	0.6	0.112		
	68	15	1	16.7	11.5	15.2	10 000	9 000	5 800	12 000	6008 ZZ	6008 2RU	6008 2RD	6008 2RS	45	46.5	63	1	0.192		
	80	18	1.1	29.1	17.8	14.0	8 300	7 500	5 400	10 000	6208 ZZ	6208 2RU	6208 2RD	6208 2RS	46.5	49	73.5	1	0.366		
	90	23	1.5	40.7	24.0	13.2	7 700	6 900	5 100	9 200	6308 ZZ	6308 2RU	6308 2RD	6308 2RS	48	51.5	82	1.5	0.633		

[Remark] Standard cage types used for the above bearings are described earlier in this section.

Single-row deep groove ball bearings
shielded type
sealed type

d 45 ~ (70) mm



Boundary dimensions (mm)				Basic load ratings (kN)		Factor f_0	Limiting speeds (min^{-1})				Bearing No.				Mounting dimensions (mm)				(Refer.) Mass Open type (kg)
d	D	B	r_{min}	C_r	C_{0r}		Grease lub.		Oil lub.	Shielded		Non-contact sealed	Extremely light contact sealed	Contact sealed	d_a min.	d_a max.	D_a max.	r_a max.	
							[Z, ZZ RU, 2RU]	(RD, 2RD)	(RS, 2RS)	(Z)									
45	58	7	0.3	6.20	5.40	16.3	11 000	9 900	5 900	13 000	6809 ZZ	6809 2RU	6809 2RD	6809 2RS	47	47	56	0.3	0.040
	68	12	0.6	14.1	10.9	15.9	9 700	8 700	5 500	11 000	6909 ZZ	6909 2RU	6909 2RD	6909 2RS	49	50	64	0.6	0.132
	75	16	1	21.0	15.1	15.3	9 200	8 300	5 300	11 000	6009 ZZ	6009 2RU	6009 2RD	6009 2RS	50	51.5	70	1	0.245
	85	19	1.1	32.7	20.3	14.0	7 700	6 900	5 100	9 200	6209 ZZ	6209 2RU	6209 2RD	6209 2RS	51.5	53.5	78.5	1	0.407
	100	25	1.5	48.9	29.5	13.3	6 800	6 100	4 500	8 100	6309 ZZ	6309 2RU	6309 2RD	6309 2RS	53	59.5	92	1.5	0.833
50	65	7	0.3	6.60	6.10	16.1	9 600	8 600	5 200	11 000	6810 ZZ	6810 2RU	6810 2RD	6810 2RS	52	53	63	0.3	0.052
	72	12	0.6	14.5	11.7	16.1	9 000	—	5 000	11 000	6910 ZZ	6910 2RU	—	—	54	55.5	68	0.6	0.133
	80	16	1	21.8	16.6	15.6	8 400	7 600	4 800	9 900	6010 ZZ	6010 2RU	6010 2RD	6010 2RS	55	57	75	1	0.261
	90	20	1.1	35.1	23.3	14.4	7 100	6 400	4 600	8 500	6210 ZZ	6210 2RU	6210 2RD	6210 2RS	56.5	59	83.5	1	0.463
	110	27	2	62.0	38.3	13.2	6 100	5 500	4 100	7 300	6310 ZZ	6310 2RU	6310 2RD	6310 2RS	59	66.5	101	2	1.07
55	72	9	0.3	8.80	8.10	16.2	8 700	7 800	—	10 000	6811 ZZ	6811 2RU	6811 2RD	—	57	58.5	70	0.3	0.083
	80	13	1	16.6	14.1	16.2	8 100	7 300	4 500	9 600	6911 ZZ	6911 2RU	6911 2RD	6911 2RS	60	60.5	75	1	0.185
	90	18	1.1	28.3	21.2	15.3	7 600	6 800	4 300	8 900	6011 ZZ	6011 2RU	6011 2RD	6011 2RS	61.5	62	83.5	1	0.385
	100	21	1.5	43.4	29.4	14.4	6 300	5 700	4 100	7 600	6211 ZZ	6211 2RU	6211 2RD	6211 2RS	63	66	92	1.5	0.607
	120	29	2	71.6	45.0	13.2	5 600	—	3 700	6 700	6311 ZZ	6311 2RU	—	6311 2RS	64	74.5	111	2	1.37
60	78	10	0.3	11.5	10.6	16.3	8 000	7 200	—	9 400	6812 ZZ	6812 2RU	6812 2RD	—	62	63	76	0.3	0.104
	85	13	1	20.2	17.3	16.2	7 500	—	—	8 900	6912 ZZ	6912 2RU	—	—	65	66	80	1	0.192
	95	18	1.1	29.4	23.2	15.6	7 100	—	4 000	8 400	6012 ZZ	6012 2RU	—	6012 2RS	66.5	68.5	88.5	1	0.415
	110	22	1.5	52.4	36.2	14.4	5 700	5 100	3 700	6 900	6212 ZZ	6212 2RU	6212 2RD	6212 2RS	68	72.5	102	1.5	0.783
	130	31	2.1	81.9	52.2	13.2	5 200	—	3 500	6 200	6312 ZZ	6312 2RU	—	6312 2RS	71	80	119	2	1.70
65	85	10	0.6	11.9	11.5	16.2	7 300	6 600	—	8 600	6813 ZZ	6813 2RU	6813 2RD	—	69	69	81	0.6	0.126
	90	13	1	17.4	16.1	16.6	7 100	6 400	3 900	8 400	6913 ZZ	6913 2RU	6913 2RD	6913 2RS	70	71	85	1	0.211
	100	18	1.1	30.5	25.2	15.8	6 600	—	3 700	7 800	6013 ZZ	6013 2RU	—	6013 2RS	71.5	74.5	93.5	1	0.435
	120	23	1.5	57.2	40.1	14.4	5 400	—	3 500	6 400	6213 ZZ	6213 2RU	—	6213 2RS	73	79	112	1.5	0.990
	140	33	2.1	92.7	59.9	13.2	4 800	—	3 200	5 800	6313 ZZ	6313 2RU	—	6313 2RS	76	86	129	2	2.08
70	90	10	0.6	12.1	11.9	16.1	6 800	6 100	—	8 100	6814 ZZ	6814 2RU	6814 2RD	—	74	74	86	0.6	0.134
	100	16	1	23.7	21.2	16.3	6 400	5 800	3 600	7 600	6914 ZZ	6914 2RU	6914 2RD	6914 2RS	75	76.5	95	1	0.342

[Remark] Standard cage types used for the above bearings are described earlier in this section.

Single-row deep groove ball bearings
shielded type
sealed type

d (70) ~ 95 mm

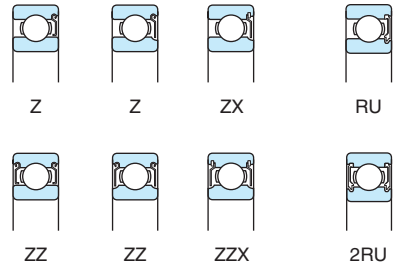
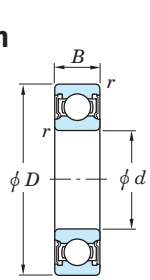

Shielded Non-contact sealed

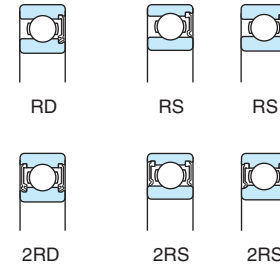

Extremely light contact sealed Contact sealed

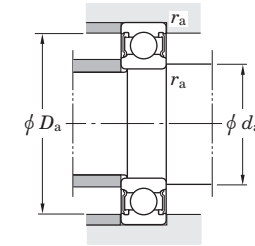

Boundary dimensions (mm)				Basic load ratings (kN)		Factor f_0	Limiting speeds (min^{-1})				Bearing No.				Mounting dimensions (mm)				(Refer.) Mass Open type (kg)
d	D	B	r_{min}	C_r	C_{0r}		Grease lub.		Oil lub.	Shielded		Non-contact sealed	Extremely light contact sealed	Contact sealed	d_a min.	d_a max.	D_a max.	r_a max.	
							$\left\{ \begin{matrix} Z, ZZ \\ RU, 2RU \end{matrix} \right\}$	(RD, 2RD)	(RS, 2RS)	(Z)									
70	110	20	1.1	38.1	30.9	15.6	6 100	—	3 500	7 200	6014 ZZ	—	—	6014 2RS	76.5	79.5	103.5	1	0.602
	125	24	1.5	62.2	44.1	14.5	5 100	—	3 300	6 100	6214 ZZ	—	—	6214 2RS	78	84	117	1.5	1.07
	150	35	2.1	104	68.2	13.2	4 500	—	3 000	5 400	6314 ZZ	—	—	6314 2RS	81	92	139	2	2.52
75	95	10	0.6	12.5	12.9	16.0	6 400	5 800	—	7 600	6815 ZZ	6815 2RU	6815 2RD	—	79	79	91	0.6	0.142
	105	16	1	24.4	22.6	16.5	6 100	—	—	7 200	6915 ZZ	6915 2RU	—	—	80	82.5	100	1	0.363
	115	20	1.1	39.6	33.5	15.8	5 700	—	3 300	6 800	6015 ZZ	6015 2RU	—	6015 2RS	81.5	84.5	108.5	1	0.638
	130	25	1.5	67.4	48.3	14.5	4 800	—	3 100	5 800	6215 ZZ	6215 2RU	—	6215 2RS	83	88.5	122	1.5	1.18
	160	37	2.1	113	77.2	13.2	4 200	—	2 800	5 000	6315 ZZ	6315 2RU	—	6315 2RS	86	97.5	149	2	3.02
80	100	10	0.6	12.7	13.3	16.0	6 100	5 500	—	7 200	6816 ZZ	6816 2RU	6816 2RD	—	84	84	96	0.6	0.150
	110	16	1	25.0	24.0	16.6	5 700	5 100	3 200	6 800	6916 ZZ	6916 2RU	6916 2RD	6916 2RS	85	86.5	105	1	0.382
	125	22	1.1	47.6	39.8	15.6	5 300	—	3 100	6 300	6016 ZZ	6016 2RU	—	6016 2RS	86.5	90	118.5	1	0.850
	140	26	2	72.7	53.0	14.6	4 500	—	2 900	5 400	6216 ZZ	6216 2RU	—	6216 2RS	89	93	131	2	1.40
	170	39	2.1	123	86.7	13.3	3 900	—	2 700	4 700	6316 ZZ	6316 2RU	—	6316 2RS	91	105	159	2	3.59
85	110	13	1	18.7	19.0	16.2	5 600	5 000	—	6 600	6817 ZZ	6817 2RU	6817 2RD	—	90	90.5	105	1	0.266
	120	18	1.1	31.9	29.6	16.4	5 300	4 800	3 000	6 300	6917 ZZ	6917 2RU	6917 2RD	6917 2RS	91.5	92.5	113.5	1	0.535
	130	22	1.1	49.5	43.1	15.8	5 000	—	2 900	5 900	6017 ZZ	6017 2RU	—	6017 2RS	91.5	96.5	123.5	1	0.890
	150	28	2	84.0	61.9	14.5	4 200	—	2 700	5 000	6217 ZZ	6217 2RU	—	6217 2RS	94	102	141	2	1.79
	180	41	3	133	96.8	13.3	3 700	—	2 500	4 400	6317 ZZ	6317 2RU	—	6317 2RS	98	111	167	2.5	4.23
90	115	13	1	19.0	19.7	16.1	5 300	4 800	—	6 300	6818 ZZ	6818 2RU	6818 2RD	—	95	95.5	110	1	0.279
	125	18	1.1	32.8	31.6	16.5	5 100	4 600	2 800	6 000	6918 ZZ	6918 2RU	6918 2RD	6918 2RS	96.5	97.5	118.5	1	0.565
	140	24	1.5	58.2	49.7	15.6	4 700	—	2 700	5 600	6018 ZZ	6018 2RU	—	6018 2RS	98	100.5	132	1.5	1.16
	160	30	2	96.1	71.5	14.5	3 900	—	2 600	4 700	6218 ZZ	6218 2RU	—	6218 2RS	99	108.5	151	2	2.15
	190	43	3	143	107	13.3	3 500	—	2 400	4 200	6318 ZZ	6318 2RU	—	6318 2RS	103	117	177	2.5	4.91
95	130	18	1.1	33.7	33.5	16.6	4 800	4 300	2 700	5 700	6919 ZZ	6919 2RU	6919 2RD	6919 2RS	101.5	102	123.5	1	0.705
	145	24	1.5	60.4	53.9	15.8	4 400	—	2 500	5 200	6019 ZZ	6019 2RU	—	6019 2RS	103	107.5	137	1.5	1.21
	170	32	2.1	109	81.9	14.4	3 700	—	2 400	4 400	6219 ZZ	6219 2RU	—	6219 2RS	106	113	159	2	2.62
	200	45	3	153	119	13.3	3 300	—	2 200	4 000	6319 ZZ	6319 2RU	—	6319 2RS	108	122	187	2.5	5.67

[Remark] Standard cage types used for the above bearings are described earlier in this section.

Single-row deep groove ball bearings shielded type sealed type

d 100 ~ (140) mm



Boundary dimensions (mm)				Basic load ratings (kN)		Factor f_0	Limiting speeds (min^{-1})				Bearing No.				Mounting dimensions (mm)				(Refer.) Mass Open type (kg)
d	D	B	r_{min}	C_r	C_{0r}		Grease lub.		Oil lub.	Shielded		Non-contact sealed	Extremely light contact sealed	Contact sealed	d_a min.	d_a max.	D_a max.	r_a max.	
							{ Z, ZZ } { RU, 2RU }	(RD, 2RD)	(RS, 2RS)	(Z)									
100	125	13	1	19.6	21.2	16.0	4 800	4 300	—	5 700	6820 ZZ	6820 2RU	6820 2RD	—	105	105.5	120	1	0.309
	140	20	1.1	45.0	41.9	16.2	4 500	—	—	5 300	6920-1 ZZ	6920-1 2RU	—	—	106.5	110.5	133.5	1	0.960
	150	24	1.5	60.2	54.2	15.9	4 300	—	2 500	5 100	6020 ZZ	6020 2RU	—	6020 2RS	108	112	142	1.5	1.25
	180	34	2.1	122	93.1	14.4	3 500	—	2 300	4 200	6220 ZZ	6220 2RU	—	6220 2RS	111	122	169	2	3.14
	215	47	3	173	141	13.2	3 000	—	2 100	3 600	6320 ZZ	6320 2RU	—	6320 2RS	113	131	202	2.5	7.00
105	145	20	1.1	46.5	44.8	16.4	4 300	—	2 400	5 100	6921-1 ZZ	6921-1 2RU	—	6921-1 2RS	111.5	115	138.5	1	1.00
	160	26	2	72.3	65.8	15.8	4 000	—	2 300	4 700	6021 ZZ	6021 2RU	—	6021 2RS	114	119	151	2	1.59
	190	36	2.1	133	105	14.4	3 300	—	2 200	3 900	6221 ZZ	6221 2RU	—	6221 2RS	116	127	179	2	3.70
	225	49	3	184	153	13.2	2 900	—	2 000	3 500	6321 ZZ	6321 2RU	—	6321 2RS	118	136	212	2.5	8.05
110	140	16	1	28.1	30.7	16.1	4 300	3 900	—	5 100	6822 ZZ	6822 2RU	6822 2RD	—	115	116.5	135	1	0.606
	150	20	1.1	47.9	47.8	16.4	4 100	—	—	4 900	6922 ZZ	6922 2RU	—	—	116.5	119.5	143.5	1	1.04
	170	28	2	82.0	73.0	15.6	3 800	—	2 200	4 500	6022 ZZ	6022 2RU	—	6022 2RS	119	123	161	2	1.96
	200	38	2.1	144	117	14.4	3 100	—	2 000	3 700	6222 ZZ	6222 2RU	—	6222 2RS	121	136.5	189	2	4.36
	240	50	3	205	180	13.2	2 700	—	1 900	3 200	6322 ZZ	6322 2RU	—	6322 2RS	123	146.5	227	2.5	9.54
120	150	16	1	29.0	33.0	16.0	4 000	—	—	4 700	6824 ZZ	6824 2RU	—	—	125	128.5	145	1	0.655
	165	22	1.1	57.2	56.9	16.4	3 800	—	—	4 400	6924 ZZ	6924 2RU	—	—	126.5	131.5	158.5	1	1.41
	180	28	2	85.0	79.3	15.9	3 600	—	2 100	4 200	6024 ZZ	6024 2RU	—	6024 2RS	129	136	171	2	2.07
	215	40	2.1	155	131	14.4	2 900	—	1 900	3 400	6224 ZZ	6224 2RU	—	6224 2RS	131	144	204	2	5.15
	260	55	3	207	185	13.5	2 500	—	—	3 000	6324 ZZ	—	—	—	133	158	247	2.5	12.5
130	165	18	1.1	36.9	41.2	16.1	3 600	—	—	4 300	6826 ZZ	6826 2RU	—	—	136.5	139.5	158.5	1	0.939
	180	24	1.5	65.2	67.4	16.3	3 400	—	—	4 100	6926-1 ZZ	6926-1 2RU	—	—	138	144	172	1.5	1.86
	200	33	2	106	101	15.8	3 200	—	1 900	3 800	6026 ZZ	6026 2RU	—	6026 2RS	139	146.5	191	2	3.16
	230	40	3	167	146	14.5	2 700	—	1 800	3 200	6226 ZZ	6226 2RU	—	6226 2RS	143	157	217	2.5	5.82
	280	58	4	229	214	13.6	2 300	—	—	2 700	6326 ZZ	—	—	—	146	171	264	3	15.1
140	175	18	1.1	38.2	44.4	16.0	3 400	3 100	—	4 000	6828 ZZ	—	6828 2RD	—	146.5	148	168.5	1	1.00
	190	24	1.5	71.3	74.8	16.5	3 200	—	—	3 800	6928-1 ZZ	6928-1 2RU	—	—	148	153	182	1.5	1.98
	210	33	2	110	109	15.9	3 000	—	1 800	3 600	6028 ZZ	6028 2RU	—	6028 2RS	149	158.5	201	2	3.55

[Remark] Standard cage types used for the above bearings are described earlier in this section.

Single-row deep groove ball bearings
shielded type
sealed type

d (140) ~ 220 mm



Boundary dimensions (mm)				Basic load ratings (kN)		Factor f_0	Limiting speeds (min^{-1})				Bearing No.				Mounting dimensions (mm)				(Refer.) Mass Open type (kg)
d	D	B	r_{min}	C_r	C_{0r}		Grease lub.		Oil lub.	Shielded		Non-contact sealed	Extremely light contact sealed	Contact sealed	d_a min.	d_a max.	D_a max.	r_a max.	
							[Z, ZZ RU, 2RU]	(RD, 2RD)	(RS, 2RS)	(Z)									
140	250	42	3	166	150	14.8	2 400	—	1 600	2 900	6228 ZZ	6228 2RU	—	6228 2RS	153	169	237	2.5	7.45
	300	62	4	253	246	13.6	2 100	—	—	2 500	6328 ZZ	—	—	—	156	184	284	3	19.4
150	210	28	2	93.4	94.3	16.2	2 900	—	1 700	3 400	6930 ZZ	6930 2RU	—	6930 2RS	159	165.5	201	2	3.05
	225	35	2.1	125	126	16.0	2 800	—	1 600	3 300	6030 ZZ	6030 2RU	—	6030 2RS	161	168.5	214	2	4.22
	270	45	3	176	168	15.1	2 200	—	—	2 700	6230 ZZ	—	—	—	163	183.5	257	2.5	9.41
160	200	20	1.1	48.4	56.9	16.1	2 900	2 600	—	3 400	6832 ZZ	—	6832 2RD	—	166.5	168.5	193.5	1	1.45
	240	38	2.1	136	135	15.9	2 600	—	1 500	3 000	6032 ZZ	6032 2RU	—	6032 2RS	171	178.5	229	2	5.22
	290	48	3	185	186	15.4	2 100	—	—	2 500	6232 ZZ	—	—	—	173	198	277	2.5	14.3
170	215	22	1.1	59.8	70.5	16.1	2 700	—	—	3 200	6834 ZZ	—	—	—	176.5	182.5	208.5	1	1.90
	260	42	2.1	161	161	15.8	2 400	—	—	2 800	6034 ZZ	6034 2RU	—	—	181	194	249	2	6.80
	310	52	4	212	223	15.3	1 900	—	—	2 300	6234 ZZ	—	—	—	186	210.5	294	3	17.5
180	225	22	1.1	60.7	73.1	16.1	2 600	2 300	—	3 000	6836 ZZ	—	6836 2RD	—	186.5	189.5	218.5	1	2.00
	280	46	2.1	182	194	15.8	2 200	—	—	2 600	6036 ZZ	6036 2RU	—	—	191	209.5	269	2	10.3
	320	52	4	227	241	15.1	1 800	—	—	2 200	6236-1 ZZ	—	—	—	196	220.5	304	3	18.3
190	240	24	1.5	73.1	88.1	16.1	2 400	—	—	2 800	6838 ZZ	—	—	—	198	202	232	1.5	2.60
	290	46	2.1	188	201	15.8	2 100	—	—	2 500	6038 ZZ	—	—	—	201	215	279	2	10.8
200	310	51	2.1	217	243	15.6	1 900	—	—	2 300	6040 ZZ	—	—	—	211	228	299	2	14.0
	360	58	4	269	311	15.2	1 600	—	—	1 900	6240-1 ZZ	—	—	—	216	250	344	3	28.2
220	340	56	3	235	271	15.6	1 700	—	—	2 000	6044 ZZ	—	—	—	233	251	327	2.5	18.3

[Remark] Standard cage types used for the above bearings are described earlier in this section.

Single-row deep groove ball bearings
snap ring groove type
locating snap ring type

d 10 ~ 32 mm

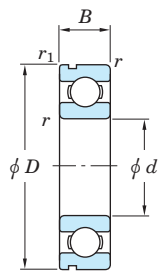

N
With snap ring groove

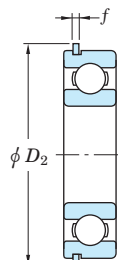

NR
With locating snap ring

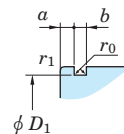

Snap ring groove details

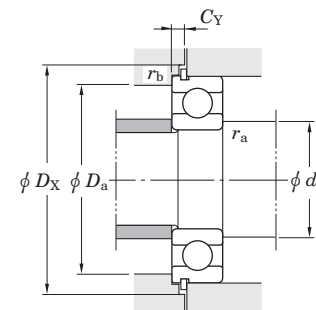

With locating snap ring and one shield

Boundary dimensions (mm)					Basic load ratings (kN)		Factor f_0	Limiting speeds (min^{-1})		Bearing No.		D_1 max.	Dimensions of snap ring groove (mm)			Dimensions of locating snap ring (mm)		Mounting dimensions (mm)						(Refer.) Mass (kg)	(Refer.) Bearing No.
d	D	B	r min.	r1 min.	C_r	C_{0r}		Grease lub.	Oil lub.	With snap ring groove	With locating snap ring		a max.	b ± 0.15	r0 max.	D_2 max.	f ± 0.05	da min.	Da max.	D_X min.	C_Y max.	ra max.	rb max.		
10	30	9	0.6	0.3	5.10	2.40	13.2	24 000	29 000	6200N	6200NR	28.17	2.06	1.5	0.4	34.7	1.07	14	26	35.5	2.92	0.6	0.3	0.032	6200N
	35	11	0.6	0.5	8.10	3.45	11.2	22 000	27 000	6300N	6300NR	33.17	2.06	1.5	0.4	39.7	1.07	14	31	40.5	2.92	0.6	0.5	0.053	6300N
12	32	10	0.6	0.3	6.80	3.05	12.3	22 000	27 000	6201N	6201NR	30.15	2.06	1.5	0.4	36.7	1.07	16	28	37.5	2.92	0.6	0.3	0.037	6201N
	37	12	1	0.5	9.70	4.20	11.1	20 000	25 000	6301N	6301NR	34.77	2.06	1.5	0.4	41.3	1.07	17	32	42	2.92	1	0.5	0.060	6301N
15	35	11	0.6	0.5	7.65	3.75	13.2	20 000	24 000	6202N	6202NR	33.17	2.06	1.5	0.4	39.7	1.07	19	31	40.5	2.92	0.6	0.5	0.045	6202N
	42	13	1	0.5	11.4	5.45	12.3	17 000	20 000	6302N	6302NR	39.75	2.06	1.5	0.4	46.3	1.07	20	37	47	2.92	1	0.5	0.082	6302N
17	40	12	0.6	0.5	9.55	4.80	13.2	17 000	21 000	6203N	6203NR	38.1	2.06	1.5	0.4	44.6	1.07	21	36	45.5	2.92	0.6	0.5	0.065	6203N
	47	14	1	0.5	13.6	6.65	12.4	15 000	18 000	6303N	6303NR	44.6	2.46	1.5	0.4	52.7	1.07	22	42	53.5	3.33	1	0.5	0.115	6303N
20	42	12	0.6	0.5	9.40	5.05	13.9	17 000	21 000	6004N	6004NR	39.75	2.06	1.5	0.4	46.3	1.07	24	38	47	2.92	0.6	0.5	0.069	6004N
	47	14	1	0.5	12.8	6.65	13.2	15 000	17 000	6204N	6204NR	44.6	2.46	1.5	0.4	52.7	1.07	25	42	53.5	3.33	1	0.5	0.106	6204N
	52	15	1.1	0.5	15.9	7.85	12.3	14 000	17 000	6304N	6304NR	49.73	2.46	1.5	0.4	57.9	1.07	26.5	45.5	58.5	3.33	1	0.5	0.144	6304N
22	44	12	0.6	0.5	9.40	5.15	14.1	17 000	20 000	60/22N	60/22NR	41.75	2.06	1.5	0.4	48.3	1.07	26	40	49	2.92	0.6	0.5	0.073	60/22N
	50	14	1	0.5	12.8	6.65	13.2	15 000	17 000	62/22N	62/22NR	47.6	2.46	1.5	0.4	55.7	1.07	27	45	56.5	3.33	1	0.5	0.118	62/22N
	56	16	1.1	0.5	18.5	9.40	12.6	13 000	15 000	63/22N	63/22NR	53.6	2.46	1.5	0.4	61.7	1.07	28.5	49.5	62.5	3.33	1	0.5	0.201	63/22N
25	47	12	0.6	0.5	10.1	5.85	14.5	15 000	18 000	6005N	6005NR	44.6	2.06	1.5	0.4	52.7	1.07	29	43	53.5	2.92	0.6	0.5	0.080	6005N
	52	15	1	0.5	14.0	7.85	13.9	13 000	15 000	6205N	6205NR	49.73	2.46	1.5	0.4	57.9	1.07	30	47	58.5	3.33	1	0.5	0.128	6205N
	62	17	1.1	0.5	20.6	11.3	13.2	11 000	13 000	6305N	6305NR	59.61	3.28	2.05	0.6	67.7	1.65	31.5	55.5	68.5	4.67	1	0.5	0.232	6305N
28	52	12	0.6	0.5	12.4	7.40	14.5	14 000	16 000	60/28N	60/28NR	49.73	2.06	1.5	0.4	57.9	1.07	32	48	58.5	2.92	0.6	0.5	0.097	60/28N
	58	16	1	0.5	17.9	9.75	13.4	12 000	14 000	62/28N	62/28NR	55.6	2.46	1.5	0.4	63.7	1.07	33	53	64.5	3.33	1	0.5	0.173	62/28N
	68	18	1.1	0.5	23.5	13.1	13.3	10 000	12 000	63/28N	63/28NR	64.82	3.28	2.05	0.6	74.6	1.65	34.5	61.5	76	4.67	1	0.5	0.328	63/28N
30	55	13	1	0.5	13.2	8.25	14.7	13 000	15 000	6006N	6006NR	52.6	2.08	1.5	0.4	60.7	1.07	35	50	61.5	2.9	1	0.5	0.116	6006N
	62	16	1	0.5	19.5	11.3	13.9	11 000	13 000	6206N	6206NR	59.61	3.28	2.05	0.6	67.7	1.65	35	57	68.5	4.67	1	0.5	0.199	6206N
	72	19	1.1	0.5	26.7	15.0	13.3	9 600	12 000	6306N	6306NR	68.81	3.28	2.05	0.6	78.6	1.65	36.5	65.5	80	4.67	1	0.5	0.346	6306N
32	58	13	1	0.5	15.0	9.15	14.5	12 000	14 000	60/32N	60/32NR	55.6	2.08	1.5	0.4	63.7	1.07	37	53	64.5	2.9	1	0.5	0.127	60/32N
	65	17	1	0.5	23.5	13.1	13.3	10 000	12 000	62/32N	62/32NR	62.6	3.28	2.05	0.6	70.7	1.65	37	60	71.5	4.67	1	0.5	0.228	62/32N
	75	20	1.1	0.5	30.1	16.2	12.7	9 300	11 000	63/32N	63/32NR	71.83	3.28	2.05	0.6	81.6	1.65	38.5	68.5	83	4.67	1	0.5	0.437	63/32N

[Remark] Standard cage types used for the above bearings are described earlier in this section.

Single-row deep groove ball bearings
snap ring groove type
locating snap ring type

d 35 ~ 75 mm

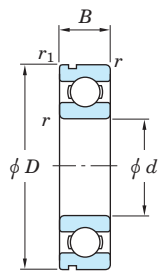

N
With snap ring groove

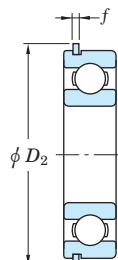

NR
With locating snap ring

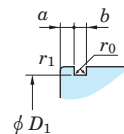

Snap ring groove details

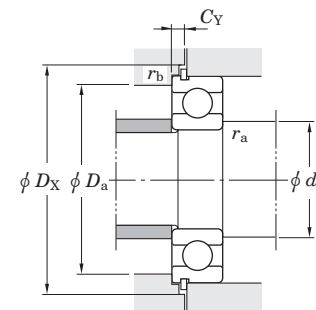

With locating snap ring and one shield

Boundary dimensions (mm)					Basic load ratings (kN)		Factor f ₀	Limiting speeds (min ⁻¹)		Bearing No.		D ₁ max.	Dimensions of snap ring groove (mm)			Dimensions of locating snap ring (mm)		Mounting dimensions (mm)						(Refer.) Mass (kg)	(Refer.) Bearing No.
d	D	B	r min.	r ₁ min.	C _r	C _{0r}		Grease lub.	Oil lub.	With snap ring groove	With locating snap ring		a max.	b ±0.15	r ₀ max.	D ₂ max.	f ±0.05	d _a min.	D _a max.	D _X min.	C _Y max.	r _a max.	r _b max.		
35	62	14	1	0.5	15.9	10.3	14.9	11 000	13 000	6007N	6007NR	59.61	2.08	2.05	0.6	67.7	1.65	40	58	68.5	3.48	1	0.5	0.155	6007N
	72	17	1.1	0.5	25.7	15.4	13.9	9 200	11 000	6207N	6207NR	68.81	3.28	2.05	0.6	78.6	1.65	41.5	65.5	80	4.67	1	0.5	0.288	6207N
	80	21	1.5	0.5	33.4	19.3	13.2	8 500	10 000	6307N	6307NR	76.81	3.28	2.05	0.6	86.6	1.65	43	72	88	4.67	1.5	0.5	0.457	6307N
40	68	15	1	0.5	16.7	11.5	15.2	10 000	12 000	6008N	6008NR	64.82	2.49	2.05	0.6	74.6	1.65	45	63	76	3.89	1	0.5	0.192	6008N
	80	18	1.1	0.5	29.1	17.8	14.0	8 300	10 000	6208N	6208NR	76.81	3.28	2.05	0.6	86.6	1.65	46.5	73.5	88	4.67	1	0.5	0.366	6208N
	90	23	1.5	0.5	40.7	24.0	13.2	7 700	9 200	6308N	6308NR	86.79	3.28	2.85	0.6	96.5	2.41	48	82	98	5.43	1.5	0.5	0.633	6308N
45	75	16	1	0.5	21.0	15.1	15.3	9 200	11 000	6009N	6009NR	71.83	2.49	2.05	0.6	81.6	1.65	50	70	83	3.89	1	0.5	0.245	6009N
	85	19	1.1	0.5	32.7	20.3	14.0	7 700	9 200	6209N	6209NR	81.81	3.28	2.05	0.6	91.6	1.65	51.5	78.5	93	4.67	1	0.5	0.407	6209N
	100	25	1.5	0.5	48.9	29.5	13.3	6 800	8 100	6309N	6309NR	96.8	3.28	2.85	0.6	106.5	2.41	53	92	108	5.43	1.5	0.5	0.833	6309N
50	80	16	1	0.5	21.8	16.6	15.6	8 400	9 900	6010N	6010NR	76.81	2.49	2.05	0.6	86.6	1.65	55	75	88	3.89	1	0.5	0.261	6010N
	90	20	1.1	0.5	35.1	23.3	14.4	7 100	8 500	6210N	6210NR	86.79	3.28	2.85	0.6	96.5	2.41	56.5	83.5	98	5.43	1	0.5	0.463	6210N
	110	27	2	0.5	62.0	38.3	13.2	6 100	7 300	6310N	6310NR	106.81	3.28	2.85	0.6	116.6	2.41	59	101	118	5.43	2	0.5	1.07	6310N
55	90	18	1.1	0.5	28.3	21.2	15.3	7 600	8 900	6011N	6011NR	86.79	2.87	2.85	0.6	96.5	2.41	61.5	83.5	98	5.03	1	0.5	0.385	6011N
	100	21	1.5	0.5	43.4	29.4	14.4	6 300	7 600	6211N	6211NR	96.8	3.28	2.85	0.6	106.5	2.41	63	92	108	5.43	1.5	0.5	0.607	6211N
	120	29	2	0.5	71.6	45.0	13.2	5 600	6 700	6311N	6311NR	115.21	4.06	3.25	0.6	129.7	2.77	64	111	131.5	6.58	2	0.5	1.37	6311N
60	95	18	1.1	0.5	29.4	23.2	15.6	7 100	8 400	6012N	6012NR	91.82	2.87	2.85	0.6	101.6	2.41	66.5	88.5	103	5.03	1	0.5	0.415	6012N
	110	22	1.5	0.5	52.4	36.2	14.4	5 700	6 900	6212N	6212NR	106.81	3.28	2.85	0.6	116.6	2.41	68	102	118	5.43	1.5	0.5	0.783	6212N
	130	31	2.1	0.5	81.9	52.2	13.2	5 200	6 200	6312N	6312NR	125.22	4.06	3.25	0.6	139.7	2.77	71	119	141.5	6.58	2	0.5	1.70	6312N
65	100	18	1.1	0.5	30.5	25.2	15.8	6 600	7 800	6013N	6013NR	96.8	2.87	2.85	0.6	106.5	2.41	71.5	93.5	108	5.03	1	0.5	0.435	6013N
	120	23	1.5	0.5	57.2	40.1	14.4	5 400	6 400	6213N	6213NR	115.21	4.06	3.25	0.6	129.7	2.77	73	112	131.5	6.58	1.5	0.5	0.990	6213N
	140	33	2.1	0.5	92.7	59.9	13.2	4 800	5 800	6313N	6313NR	135.23	4.9	3.25	0.6	149.7	2.77	76	129	152	7.37	2	0.5	2.08	6313N
70	110	20	1.1	0.5	38.1	30.9	15.6	6 100	7 200	6014N	6014NR	106.81	2.87	2.85	0.6	116.6	2.41	76.5	103.5	118	5.03	1	0.5	0.602	6014N
	125	24	1.5	0.5	62.2	44.1	14.5	5 100	6 100	6214N	6214NR	120.22	4.06	3.25	0.6	134.7	2.77	78	117	136.5	6.58	1.5	0.5	1.07	6214N
	150	35	2.1	0.5	104	68.2	13.2	4 500	5 400	6314N	6314NR	145.24	4.9	3.25	0.6	159.7	2.77	81	139	162	7.37	2	0.5	2.52	6314N
75	115	20	1.1	0.5	39.6	33.5	15.8	5 700	6 800	6015N	6015NR	111.81	2.87	2.85	0.6	121.6	2.41	81.5	108.5	123	5.03	1	0.5	0.638	6015N
	130	25	1.5	0.5	67.4	48.3	14.5	4 800	5 800	6215N	6215NR	125.22	4.06	3.25	0.6	139.7	2.77	83	122	141.5	6.58	1.5	0.5	1.18	6215N
	160	37	2.1	0.5	113	77.2	13.2	4 200	5 000	6315N	6315NR	155.22	4.9	3.25	0.6	169.7	2.77	86	149	172	7.37	2	0.5	3.02	6315N

[Remark] Standard cage types used for the above bearings are described earlier in this section.

Extra-small ball bearings, miniature ball bearings

d 1 ~ (4) mm

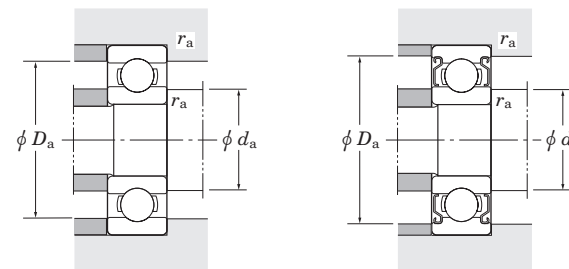
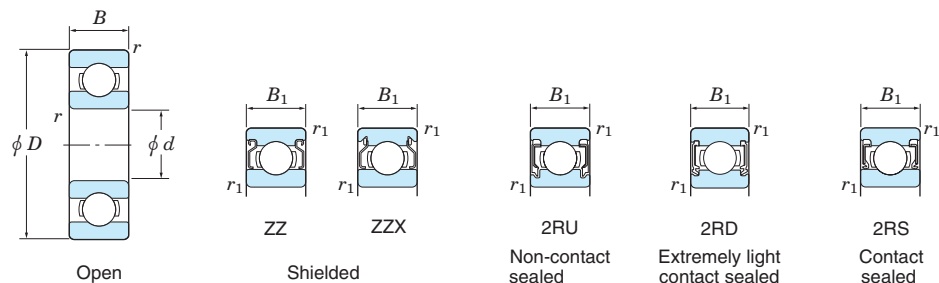

Boundary dimensions (mm)						Basic load ratings (kN)		Factor	Limiting speeds (min ⁻¹)				Bearing No.					Mounting dimensions (mm)			(Refer.) Mass (g)
d	D	B	B ₁	r ⁽¹⁾ _{min.}	r ⁽¹⁾ _{min.}	C _r	C _{0r}		f ₀	Grease lub.		Oil lub.	Open	Shielded	Non-contact sealed	Extremely light shielded	Contact sealed	d _a min.	D _a max.	r _a max.	
										[Open ZZ, 2RU]	(2RD) min.	(2RS)	[Open Z]								
1	3	1	—	0.07	—	0.10	0.03	11.6	130 000	—	—	150 000	681	—	—	—	—	1.6	2.4	0.05	0.03
	3	1.5	—	0.08	—	0.08	0.02	12.8	130 000	—	—	150 000	ML1003	—	—	—	—	1.6	2.4	0.07	0.05
	4	1.6	—	0.1	—	0.14	0.04	11.4	120 000	—	—	140 000	691	—	—	—	—	1.8	3.2	0.1	0.1
1.2	4	1.8	—	0.08	—	0.11	0.03	11.4	120 000	—	—	140 000	ML1204	—	—	—	—	1.8	3.4	0.07	0.1
1.5	4	1.2	2	0.1	0.1	0.11	0.03	13.2	120 000	—	—	140 000	68/1.5	W68/1.5 ZZ	—	—	—	2.3	3.2	0.1	0.1
	5	2	2.6	0.15	0.15	0.24	0.07	13.3	110 000	—	—	130 000	69/1.5	W69/1.5 ZZX	—	—	—	2.7	3.8	0.15	0.1
	6	2.5	3	0.1	0.1	0.33	0.10	11.4	86 000	—	—	100 000	ML1506	WML1506 ZZX	—	—	—	2.3	5.2	0.1	0.3
2	5	1.5	2.3	0.1	0.1	0.17	0.05	13.3	98 000	—	—	110 000	682	W682 ZZX	—	—	—	2.8	4.4	0.1	0.1
	5	2	2.5	0.1	0.08	0.17	0.05	13.3	98 000	—	—	110 000	ML2005	WML2005 ZZ	—	—	—	2.6	4.2	0.07	0.1
	6	2.3	3	0.15	0.1	0.33	0.10	11.4	86 000	—	—	100 000	692	W692 ZZ	—	—	—	3.2	4.8	0.1	0.2
	6	2.5	3	0.1	0.1	0.33	0.10	11.4	86 000	—	—	100 000	ML2006	WML2006 ZZX	—	—	—	2.8	5.2	0.1	0.3
	7	2.5	3	0.15	0.15	0.39	0.13	12.6	67 000	—	—	79 000	ML2007	WML2007 ZZX	—	—	—	3.2	5.8	0.15	0.4
	7	2.8	3.5	0.15	0.15	0.39	0.13	12.6	67 000	—	—	79 000	602	W602 ZZX	—	—	—	3.2	5.8	0.15	0.5
	7	2.5	3	0.15	0.15	0.39	0.13	12.6	67 000	—	—	79 000									
2.5	6	1.8	2.6	0.1	0.1	0.19	0.06	14.3	75 000	—	—	89 000	68/2.5	W68/2.5 ZZ	—	—	—	3.3	5.2	0.1	0.2
	7	2.5	3.5	0.15	0.15	0.31	0.11	13.7	66 000	—	—	79 000	69/2.5	W69/2.5 ZZ	—	—	—	3.7	5.8	0.15	0.4
	8	2.5	—	0.1	—	0.43	0.15	13.4	63 000	—	—	75 000	ML2508/1B	—	—	—	—	3.3	7.2	0.1	0.6
	8	2.8	4	0.15	0.1	0.55	0.17	11.5	64 000	—	—	76 000	ML2508	WML2508 ZZX	—	—	—	3.7	6.8	0.1	0.6
3	6	2	2.5	0.08	0.05	0.19	0.06	14.3	75 000	—	—	89 000	ML3006	WML3006 ZZ	—	—	—	3.6	5.4	0.05	0.2
	7	2	3	(0.15)	(0.15)	0.31	0.11	13.7	66 000	—	—	79 000	683	W683 ZZ	—	—	—	4.2	5.8	0.1	0.3
	8	2.5	—	0.1	—	0.40	0.14	13.4	63 000	—	—	75 000	ML3008	—	—	—	—	3.8	7.2	0.1	0.5
	8	3	4	0.15	0.15	0.55	0.17	11.5	64 000	—	—	76 000	693	W693 ZZ	—	—	—	4.2	6.8	0.15	0.6
	9	3	5	0.15	0.15	0.43	0.16	14.0	60 000	—	—	72 000	603	W603 ZZX	—	—	—	4.2	7.8	0.15	0.9
	10	4	4	0.15	0.15	0.63	0.22	12.8	52 000	—	44 000	63 000	623	623 ZZ	—	—	623 2RS	4.2	8.8	0.15	1.6
	13	5	5	0.2	0.2	1.30	0.49	12.3	44 000	—	—	54 000	633	633 ZZ	—	—	—	4.6	11.4	0.2	3.0
4	7	2	2.5	0.08	0.05	0.26	0.11	15.1	64 000	—	—	76 000	ML4007	WML4007 ZZ	—	—	—	4.6	6.4	0.05	0.2
	8	2	3	0.1	0.08	0.40	0.14	14.6	61 000	—	—	73 000	ML4008	WML4008 ZZ	—	—	—	4.8	7.2	0.08	0.4
	9	2.5	4	(0.15)	(0.15)	0.64	0.23	12.8	59 000	—	—	70 000	684	W684 ZZ	—	—	—	5.2	7.8	0.1	0.6

[Note] 1) Numerical values in () do not conform to JIS B 1521.

Extra-small ball bearings, miniature ball bearings

d (4) ~ (7) mm

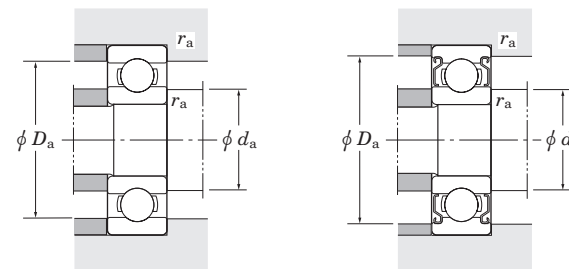
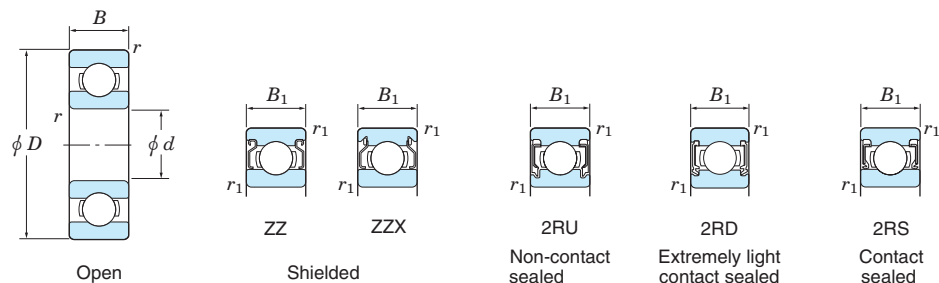

Boundary dimensions (mm)						Basic load ratings (kN)		Factor f_0	Limiting speeds (min^{-1})				Bearing No.					Mounting dimensions (mm)			(Refer.) Mass (g)
d	D	B	B_1	r_{min}	r_1 min.	C_r	C_{0r}		Grease lub.	Oil lub.	Open	(2RD)	(2RS)	Open	Shielded	Non-contact sealed	Extremely light shielded	Contact sealed	d_a min.	D_a max.	
4	10	3	4	0.15	0.1	0.65	0.23	13.3	56 000	—	—	67 000	ML4010	WML4010 ZZ	—	—	—	5.2	8.8	0.1	1.0
	11	4	4	0.15	0.15	0.96	0.35	12.4	54 000	—	44 000	65 000	694	694 ZZ	694 2RU	—	694 2RS	5.2	9.8	0.15	1.8
	12	4	4	0.2	0.2	0.96	0.35	12.4	53 000	—	—	63 000	604	604 ZZ	—	—	—	5.6	10.4	0.2	2.1
	13	5	5	0.2	0.2	1.30	0.48	12.3	44 000	—	39 000	54 000	624	624 ZZ	624 2RU	—	624 2RS	5.6	11.4	0.2	2.9
	16	5	5	0.3	0.3	1.35	0.52	12.4	40 000	—	—	49 000	634	634 ZZ	—	—	—	6	14	0.3	5.3
5	8	2	2.5	0.08	0.05	0.22	0.09	15.7	59 000	—	—	70 000	ML5008	WML5008 ZZ	—	—	—	5.6	7.4	0.05	0.3
	9	2.5	3	0.1	0.08	0.43	0.17	15.3	56 000	—	—	67 000	ML5009	WML5009 ZZ	—	—	—	5.8	8.2	0.08	0.5
	10	3	4	0.1	0.1	0.43	0.17	14.8	55 000	—	—	65 000	ML5010	WML5010 ZZ	—	—	—	5.8	9	0.1	0.9
	11	3	5	0.15	0.15	0.71	0.28	12.8	53 000	—	—	63 000	685	W685 ZZ	—	—	—	6.2	9.8	0.15	1.0
	13	4	4	0.2	0.2	1.10	0.43	12.3	50 000	45 000	42 000	60 000	695	695 ZZ	695 2RU	695 2RD	695 2RS	6.6	11.4	0.2	2.2
	14	5	5	0.2	0.2	1.30	0.49	12.3	50 000	—	—	60 000	605	605 ZZ	—	—	—	6.6	12.4	0.2	3.5
	16	5	5	0.3	0.3	1.75	0.67	12.4	40 000	36 000	33 000	49 000	625	625 ZZ	625 2RU	—	625 2RS	7	14	0.3	5.0
	19	6	6	0.3	0.3	2.35	0.89	12.3	35 000	32 000	27 000	43 000	635	635 ZZ	635 2RU	—	635 2RS	7	17	0.3	8.5
6	10	2.5	3	0.1	0.08	0.50	0.22	15.7	53 000	—	—	63 000	ML6010	WML6010 ZZ	—	—	—	6.8	9.2	0.08	0.6
	12	3	4	0.15	0.1	0.71	0.29	14.5	49 000	—	37 000	59 000	ML6012	WML6012 ZZ	—	—	WML6012 2RS	7.2	10.8	0.1	1.3
	13	3.5	5	0.15	0.15	1.10	0.44	13.7	48 000	43 000	36 000	57 000	686	W686 ZZ	—	—	W686 2RS	7.2	11.8	0.15	1.8
	15	5	5	0.2	0.2	1.35	0.52	12.4	45 000	41 000	32 000	54 000	696	696 ZZ	696 2RU	696 2RD	696 2RS	7.6	13.4	0.2	3.9
	17	6	6	0.3	0.3	1.95	0.74	12.2	43 000	39 000	—	51 000	606	606 ZZ	606 2RU	606 2RD	—	8	15	0.3	5.8
	19	6	6	0.3	0.3	2.35	0.89	12.3	35 000	32 000	27 000	43 000	626	626 ZZ	626 2RU	626 2RD	626 2RS	8	17	0.3	8.1
	19	8	8	0.3	0.3	2.60	1.05	12.3	40 000	—	—	47 000	ML6019	ML6019 ZZ	—	—	—	7	18	0.3	9.0
	22	7	7	0.3	0.3	3.30	1.35	12.4	31 000	—	23 000	37 000	636	636 ZZ	—	—	636 2RS	8	20	0.3	13
	7	11	2.5	3	0.1	0.08	0.43	0.23	16.1	49 000	—	—	59 000	ML7011	WML7011 ZZX	—	—	—	7.8	10.2	0.08
13		3	4	0.15	0.15	0.54	0.28	14.9	47 000	—	—	55 000	ML7013	WML7013 ZZ	—	—	—	8.2	11.8	0.15	1.4
14		3.5	5	0.15	0.15	1.15	0.51	14.2	45 000	—	—	54 000	687	W687 ZZ	—	—	—	8.2	12.8	0.15	2.0
17		5	5	0.3	0.3	1.60	0.71	14.0	42 000	—	28 000	50 000	697	697 ZZ	—	—	697 2RS	9	15	0.3	5.3
19		6	6	0.3	0.3	2.35	0.89	12.3	40 000	36 000	27 000	47 000	607	607 ZZ	607 2RU	607 2RD	607 2RS	9	17	0.3	7.6
22		7	7	0.3	0.3	3.30	1.35	12.4	31 000	28 000	23 000	37 000	627	627 ZZ	627 2RU	627 2RD	627 2RS	9	20	0.3	13
22		8	8	0.3	0.3	3.30	1.35	12.4	34 000	—	—	41 000	ML7022	ML7022 ZZ	—	—	—	9	20	0.3	14

Extra-small ball bearings, miniature ball bearings

d (7) ~ 9 mm

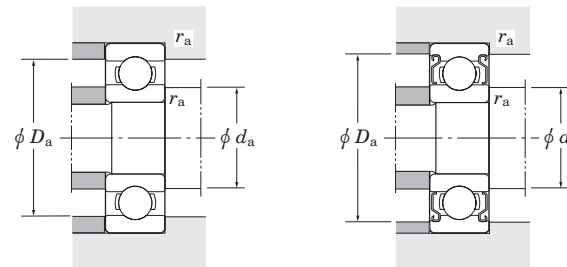
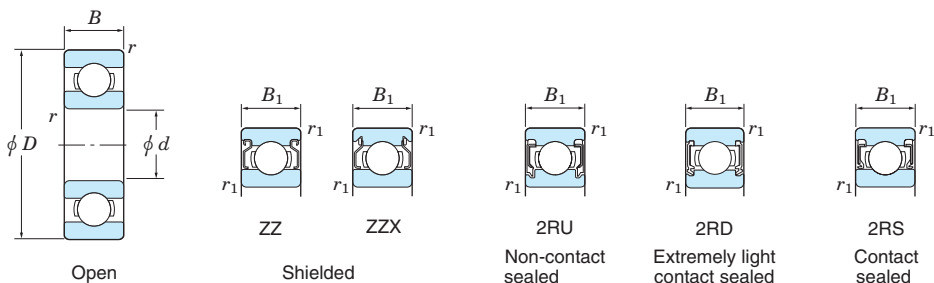

Boundary dimensions (mm)						Basic load ratings (kN)		Factor f_0	Limiting speeds (min ⁻¹)				Bearing No.					Mounting dimensions (mm)			(Refer.) Mass (g)
d	D	B	B ₁	r ⁽¹⁾ _{min.}	r ⁽¹⁾ _{min.}	C _r	C _{0r}		Grease lub.		Oil lub.		Open	Shielded	Non-contact sealed	Extremely light shielded	Contact sealed	d _a min.	D _a max.	r _a max.	
7	26	9	9	0.3	0.3	4.55	1.95	12.3	[Open ZZ, 2RU]	(2RD)	(2RS)	[Open Z]	637	637 ZZ	—	—	—	9	24	0.3	24
8	12	2.5	3.5	0.1	0.08	0.54	0.27	16.4	47 000	—	—	55 000	ML8012	WML8012 ZZ	—	—	—	8.8	11.2	0.08	0.8
	14	3.5	4	0.15	0.15	0.81	0.39	15.3	44 000	—	—	52 000	ML8014	WML8014 ZZ	—	—	—	9.2	12.8	0.15	1.8
	16	4	5	0.2	0.2	1.25	0.59	14.0	42 000	38 000	28 000	50 000	688	W688 ZZ	W688 2RU	W688 2RD	W688 2RS	9.6	14.4	0.2	3.2
	19	6	6	0.3	0.3	2.25	0.91	12.9	39 000	35 000	27 000	46 000	698	698 ZZ	—	698 2RD	698 2RS	10	17	0.3	7.2
	22	7	7	0.3	0.3	3.30	1.35	12.4	34 000	31 000	23 000	41 000	608	608 ZZ	608 2RU	608 2RD	608 2RS	10	20	0.3	12
	24	8	8	0.3	0.3	3.35	1.40	12.8	28 000	—	22 000	35 000	628	628 ZZ	628 2RU	—	628 2RS	10	22	0.3	18
	28	9	9	0.3	0.3	4.55	1.95	12.3	26 000	23 000	—	32 000	638	638 ZZ	—	638 2RD	—	10	26	0.3	29
9	17	4	5	0.2	0.2	1.35	0.66	14.9	39 000	35 000	—	46 000	689	W689 ZZ	W689 2RU	W689 2RD	—	10.6	15.4	0.2	3.5
	20	6	6	0.3	0.3	2.45	1.05	13.3	35 000	32 000	25 000	42 000	699	699 ZZ	—	699 2RD	699 2RS	11	18	0.3	7.5
	24	7	7	0.3	0.3	3.35	1.40	12.8	33 000	30 000	22 000	40 000	609	609 ZZ	609 2RU	609 2RD	609 2RS	11	22	0.3	15
	26	8	8	(0.6)	(0.6)	4.55	1.95	12.4	27 000	24 000	19 000	33 000	629	629 ZZ	629 2RU	629 2RD	629 2RS	12.1	22	0.3	20
	30	10	10	0.6	0.6	4.65	2.10	12.3	24 000	—	—	29 000	639	639 ZZ	—	—	—	13	26	0.6	35

[Note] 1) Numerical values in () do not conform to JIS B 1521.

Extra-small ball bearings, miniature ball bearings
flanged type

d 1 ~ (4) mm

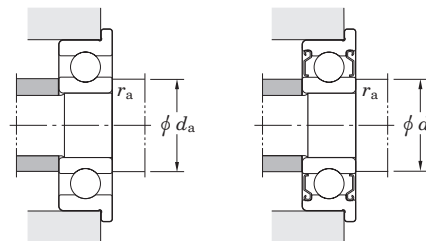
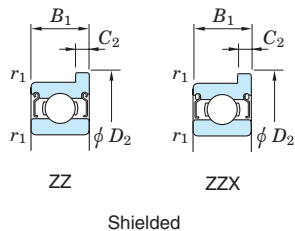
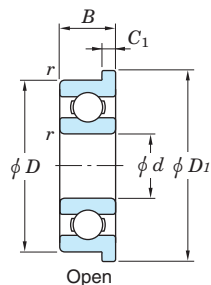

Boundary dimensions (mm)					Basic load ratings (kN)		Factor f_0	Limiting speeds (min^{-1})		Bearing No.	Dimensions of flange (mm)				Mounting dimensions (mm)		(Refer.) Mass (g)		
d	D	B	B_1	$r_1^{(1)}$ min.	$r_1^{(1)}$ min.	C_r		C_{0r}	Grease lub.		Oil lub.	Open	Shielded	D_1	D_2	C_1		C_2	d_a min.
1	3	1	—	0.07	—	0.10	0.03	11.6	130 000	150 000	F681	—	3.8	—	0.3	—	1.6	0.05	0.03
	4	1.6	—	0.1	—	0.14	0.04	11.4	120 000	140 000	F691	—	5	—	0.5	—	1.8	0.1	0.1
1.5	4	1.2	2	0.1	0.1	0.11	0.03	13.2	120 000	140 000	F68/1.5	WF68/1.5 ZZ	5	5	0.4	0.6	2.3	0.1	0.1
	5	2	2.6	0.15	0.15	0.24	0.07	12.9	110 000	120 000	F69/1.5	WF69/1.5 ZZ	6.5	6.5	0.6	0.8	2.7	0.15	0.2
	6	2.5	3	0.1	0.1	0.33	0.10	11.4	86 000	100 000	MLF1506	WMLF1506 ZZ	7.5	7.5	0.6	0.8	2.3	0.1	0.4
2	5	1.5	2.3	0.1	0.1	0.17	0.05	13.3	99 000	120 000	F682	WF682 ZZ	6.1	6.1	0.5	0.6	2.8	0.1	0.1
	5	2	2.5	0.1	0.08	0.17	0.05	12.9	99 000	120 000	MLF2005	WMLF2005 ZZ	6.2	6.2	0.6	0.6	2.8	0.07	0.2
	6	2.3	3	0.15	0.1	0.33	0.10	11.4	86 000	100 000	F692	WF692 ZZ	7.5	7.5	0.6	0.8	3.2	0.1	0.3
	6	2.5	3	0.1	0.1	0.33	0.10	11.4	86 000	100 000	MLF2006	WMLF2006 ZZ	7.2	7.2	0.6	0.6	2.8	0.1	0.4
	7	2.5	3	0.15	0.15	0.39	0.13	12.6	67 000	79 000	MLF2007	WMLF2007 ZZ	8.2	8.2	0.6	0.6	3.2	0.15	0.5
	7	2.8	3.5	0.15	0.15	0.39	0.13	12.6	67 000	79 000	F602	WF602 ZZ	8.5	8.5	0.7	0.9	3.2	0.15	0.6
2.5	6	1.8	2.6	0.1	0.1	0.21	0.07	14.3	69 000	82 000	F68/2.5	WF68/2.5 ZZ	7.1	7.1	0.5	0.8	3.3	0.1	0.2
	7	2.5	3.5	0.15	0.15	0.39	0.13	12.7	66 000	79 000	F69/2.5	WF69/2.5 ZZ	8.5	8.5	0.7	0.9	3.7	0.15	0.5
	8	2.5	—	0.1	—	0.56	0.18	11.7	63 000	75 000	MLF2508/1B	—	9.2	—	0.6	—	3.5	0.1	0.7
	8	2.8	4	0.15	0.1	0.56	0.18	11.5	63 000	75 000	MLF2508	WMLF2508 ZZ	9.5	9.5	0.7	0.9	3.7	0.1	0.7
3	6	2	2.5	0.08	0.05	0.21	0.07	14.3	69 000	82 000	MLF3006	WMLF3006 ZZ	7.2	7.2	0.6	0.6	3.6	0.05	0.2
	7	2	3	(0.15)	(0.15)	0.31	0.11	14.0	65 000	78 000	F683	WF683 ZZ	8.1	8.1	0.5	0.8	4.2	0.1	0.4
	8	2.5	—	0.1	—	0.40	0.14	13.4	61 000	72 000	MLF3008	—	9.2	—	0.6	—	4.0	0.1	0.6
	8	3	4	0.15	0.15	0.56	0.18	11.9	63 000	75 000	F693	WF693 ZZ	9.5	9.5	0.7	0.9	4.2	0.15	0.7
	9	3	5	0.15	0.15	0.57	0.19	12.4	60 000	72 000	F603	WF603 ZZ	10.5	10.5	0.7	1	4.2	0.15	1.0
	10	4	4	0.15	0.15	0.63	0.22	12.4	61 000	72 000	F623	F623 ZZ	11.5	11.5	1	1	4.2	0.15	1.8
4	7	2	2.5	0.08	0.05	0.25	0.11	15.1	63 000	75 000	MLF4007	WMLF4007 ZZ	8.2	8.2	0.6	0.6	4.6	0.05	0.3
	8	2	3	0.1	0.08	0.40	0.14	13.9	61 000	72 000	MLF4008	WMLF4008 ZZ	9.2	9.2	0.6	0.6	4.8	0.08	0.5
	9	2.5	4	(0.15)	(0.15)	0.64	0.23	12.8	59 000	70 000	F684	WF684 ZZ	10.3	10.3	0.6	1	5.2	0.1	0.7
	10	3	4	0.15	0.1	0.71	0.27	13.5	56 000	66 000	MLF4010	WMLF4010 ZZ	11.2	11.6	0.6	0.8	5.2	0.1	1.1
	11	4	4	0.15	0.15	0.96	0.35	12.4	54 000	65 000	F694	F694 ZZ	12.5	12.5	1	1	5.2	0.15	2.0
	12	4	4	0.2	0.2	0.96	0.35	12.4	54 000	65 000	F604	F604 ZZ	13.5	13.5	1	1	5.6	0.2	2.3

[Note] 1) Numerical values in () do not conform to JIS B 1521.

Extra-small ball bearings, miniature ball bearings
flanged type

d (4) ~ 8 mm

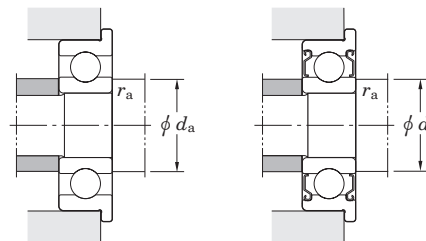
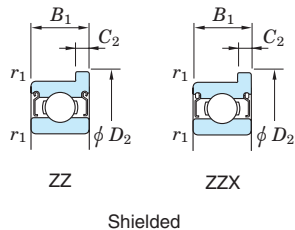
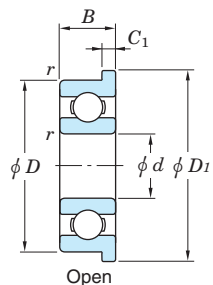

Boundary dimensions (mm)					Basic load ratings (kN)		Factor f_0	Limiting speeds (min^{-1})		Bearing No.	Dimensions of flange (mm)				Mounting dimensions (mm)		(Refer.) Mass (g)		
d	D	B	B_1	r_{min}	r_1_{min}	C_r		C_{0r}	Grease lub.		Oil lub.	Open	Shielded	D_1	D_2	C_1		C_2	d_a_{min}
4	13	5	5	0.2	0.2	1.30	0.48	12.2	50 000	60 000	F624 F634	F624 ZZ F634 ZZ	15	15	1	1	5.6	0.2	3.3
	16	5	5	0.3	0.3	1.35	0.52	13.0	47 000	55 000			18	18	1	1	6	0.3	5.7
5	8	2	2.5	0.08	0.05	0.22	0.09	15.8	59 000	70 000	MLF5008 MLF5009 MLF5010	WMLF5008 ZZ WMLF5009 ZZ WMLF5010 ZZ	9.2	9.2	0.6	0.6	5.6	0.05	0.4
	9	2.5	3	0.1	0.08	0.43	0.17	14.6	57 000	67 000			10.2	10.2	0.6	0.6	5.8	0.08	0.6
	10	3	4	0.1	0.1	0.43	0.17	14.8	57 000	67 000			11.2	11.6	0.6	0.8	5.8	0.1	1.0
	11	3	5	0.15	0.15	0.71	0.28	14.0	53 000	63 000	F685 F695 F605	WF685 ZZ F695 ZZ F605 ZZ	12.5	12.5	0.8	1	6.2	0.15	1.1
	13	4	4	0.2	0.2	1.10	0.43	13.4	49 000	59 000			15	15	1	1	6.6	0.2	2.5
	14	5	5	0.2	0.2	1.35	0.51	12.3	48 000	57 000	F625 F635	F625 ZZ F635 ZZ	16	16	1	1	6.6	0.2	3.9
	16	5	5	0.3	0.3	1.75	0.67	12.4	45 000	54 000			18	18	1	1	7	0.3	5.4
	19	6	6	0.3	0.3	2.35	0.89	12.3	40 000	47 000			22	22	1.5	1.5	7	0.3	9.7
6	10	2.5	3	0.1	0.08	0.50	0.22	15.2	53 000	63 000	MLF6010 MLF6012 F686	WMLF6010 ZZ WMLF6012 ZZ WF686 ZZ	11.2	11.2	0.6	0.6	6.8	0.08	0.7
	12	3	4	0.15	0.1	0.71	0.29	14.5	49 000	59 000			13.2	13.6	0.6	0.8	7.2	0.1	1.4
	13	3.5	5	0.15	0.15	1.10	0.44	13.7	48 000	57 000			15	15	1	1.1	7.2	0.15	2.1
	15	5	5	0.2	0.2	1.35	0.52	13.0	47 000	55 000	F696 F606 F626 F636	F696 ZZ F606 ZZ F626 ZZ F636 ZZ	17	17	1.2	1.2	7.6	0.2	4.3
	17	6	6	0.3	0.3	2.25	0.84	11.4	43 000	52 000			19	19	1.2	1.2	8	0.3	6.3
	19	6	6	0.3	0.3	2.35	0.89	12.3	40 000	47 000			22	22	1.5	1.5	8	0.3	9.2
	22	7	7	0.3	0.3	3.30	1.35	12.4	34 000	41 000			25	25	1.5	1.5	8	0.3	14
7	11	2.5	3	0.1	0.08	0.46	0.20	15.6	49 000	59 000	MLF7011 MLF7013 F687	WMLF7011 ZZ WMLF7013 ZZ WF687 ZZ	12.2	12.2	0.6	0.6	7.8	0.08	0.8
	13	3	4	0.15	0.15	0.54	0.28	16.0	46 000	55 000			14.2	14.6	0.6	0.8	8.2	0.15	1.5
	14	3.5	5	0.15	0.15	1.15	0.51	14.2	45 000	54 000			16	16	1	1.1	8.2	0.15	2.4
	17	5	5	0.3	0.3	1.60	0.71	14.0	42 000	50 000	F697 F607 F627	F697 ZZ F607 ZZ F627 ZZ	19	19	1.2	1.2	9	0.3	5.8
	19	6	6	0.3	0.3	2.35	0.89	12.1	40 000	47 000			22	22	1.5	1.5	9	0.3	8.7
	22	7	7	0.3	0.3	3.30	1.35	12.4	34 000	41 000			25	25	1.5	1.5	9	0.3	14
8	12	2.5	3.5	0.1	0.08	0.54	0.27	15.9	47 000	55 000	MLF8012 MLF8014 F688	WMLF8012 ZZ WMLF8014 ZZ WF688 ZZ	13.2	13.6	0.6	0.8	8.8	0.08	0.9
	14	3.5	4	0.15	0.15	0.87	0.42	15.3	44 000	52 000			15.6	15.6	0.8	0.8	9.2	0.15	2.0
	16	4	5	0.2	0.2	1.25	0.59	14.8	42 000	50 000	F698 F608	F698 ZZ F608 ZZ	18	18	1	1.1	9.6	0.2	3.6
	19	6	6	0.3	0.3	2.25	0.91	12.9	39 000	46 000			22	22	1.5	1.5	10	0.3	8.3
	22	7	7	0.3	0.3	3.30	1.35	12.4	34 000	41 000			25	25	1.5	1.5	10	0.3	13

Extra-small ball bearings, miniature ball bearings
flanged type

d 9 mm

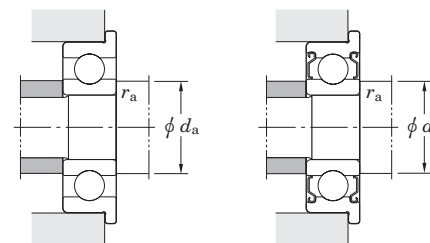
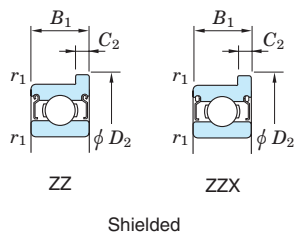
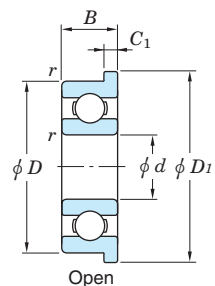

d	Boundary dimensions (mm)					Basic load ratings (kN)		Factor f_0	Limiting speeds (min^{-1})		Bearing No.		Dimensions of flange (mm)				Mounting dimensions (mm)		(Refer.) Mass (g)
	D	B	B_1	$r_{\text{min.}}$	$r_{1\text{min.}}$	C_r	C_{0r}		Grease lub.	Oil lub.	Open	Shielded	D_1	D_2	C_1	C_2	d_a min.	r_a max.	
9	17	4	5	0.2	0.2	1.35	0.66	15.1	39 000	46 000	F689	WF689 ZZ	19	19	1	1.1	10.6	0.2	3.9
	20	6	6	0.3	0.3	2.45	1.05	13.3	37 000	44 000	F699	F699 ZZ	23	23	1.5	1.5	11	0.3	8.7
	24	7	7	0.3	0.3	3.35	1.45	12.8	32 000	38 000	F609	F609 ZZ	27	27	1.5	1.5	11	0.3	16

Double-row deep groove ball bearings

d 10 ~ (60) mm

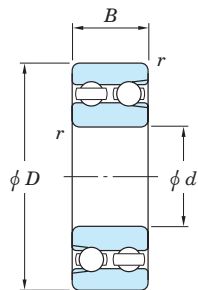

Boundary dimensions (mm)				Basic load ratings (kN)		Factor f_0	Limiting speeds (min^{-1})		Bearing No.	Mounting dimensions (mm)			(Refer.) Mass (kg)
d	D	B	$r_{\text{min.}}$	C_r	C_{0r}		Grease lub.	Oil lub.		d_a min.	D_a max.	r_a max.	
10	30	14	0.6	7.70	5.90	13.0	15 000	20 000	4200	14	26	0.6	0.057
12	32	14	0.6	7.75	6.15	13.6	14 000	18 000	4201	16	28	0.6	0.062
15	35	14	0.6	9.75	9.00	14.2	12 000	16 000	4202	19	31	0.6	0.071
	42	17	1	13.1	11.7	13.7	11 000	14 000	4302	20	37	1	0.123
17	40	16	0.6	11.7	10.4	14.1	11 000	14 000	4203	21	36	0.6	0.106
	47	19	1	16.5	15.0	13.7	9 400	13 000	4303	22	42	1	0.171
20	47	18	1	16.4	16.0	14.2	9 000	12 000	4204	25	42	1	0.165
	52	21	1.1	19.5	17.0	13.5	8 300	11 000	4304	26.5	45.5	1	0.227
25	52	18	1	16.3	16.9	15.0	7 500	9 900	4205	30	47	1	0.189
	62	24	1.1	26.3	25.7	14.1	6 700	9 000	4305	31.5	55.5	1	0.365
30	62	20	1	22.0	24.7	15.1	6 400	8 500	4206	35	57	1	0.298
	72	27	1.1	35.5	35.9	14.0	5 700	7 600	4306	36.5	65.5	1	0.542
35	72	23	1.1	26.4	30.7	15.2	5 600	7 400	4207	41.5	65.5	1	0.460
	80	31	1.5	40.6	41.8	14.1	5 200	7 000	4307	43	72	1.5	0.752
40	80	23	1.1	33.7	42.4	15.5	4 700	6 300	4208	46.5	73.5	1	0.558
	90	33	1.5	46.0	48.8	14.7	4 600	6 100	4308	48	82	1.5	1.01
45	85	23	1.1	31.9	43.9	15.8	4 600	6 100	4209	51.5	78.5	1	0.605
	100	36	1.5	57.6	62.4	14.3	4 100	5 500	4309	53	92	1.5	1.35
50	90	23	1.1	31.4	44.6	16.1	4 200	5 600	4210	56.5	83.5	1	0.651
	110	40	2	70.4	77.7	14.2	3 700	5 000	4310	59	101	2	1.80
55	100	25	1.5	37.2	54.1	16.1	3 800	5 000	4211	63	92	1.5	0.882
	120	43	2	84.2	94.4	14.2	3 400	4 600	4311	64	111	2	2.29
60	110	28	1.5	47.9	67.6	15.9	3 500	4 700	4212	68	102	1.5	1.20

d (60) ~ 75 mm

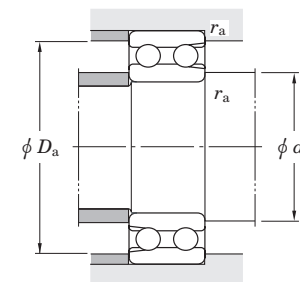

Boundary dimensions (mm)				Basic load ratings (kN)		Factor f_0	Limiting speeds (min^{-1})		Bearing No.	Mounting dimensions (mm)			(Refer.) Mass (kg)
d	D	B	$r_{\text{min.}}$	C_r	C_{0r}		Grease lub.	Oil lub.		d_a min.	D_a max.	r_a max.	
60	130	46	2.1	99.2	113	14.1	3 100	4 200	4312	71	119	2	2.87
65	120	31	1.5	54.7	78.5	15.9	3 200	4 300	4213	73	112	1.5	1.59
	140	48	2.1	107	124	14.3	2 900	3 900	4313	76	129	2	3.46
70	125	31	1.5	62.1	89.8	15.8	3 100	4 100	4214	78	117	1.5	1.68
	150	51	2.1	115	136	14.4	2 700	3 600	4314	81	139	2	4.21
75	130	31	1.5	61.6	90.7	16.0	2 900	3 900	4215	83	122	1.5	1.77
	160	55	2.1	132	158	14.4	2 500	3 400	4315	86	149	2	5.15

Angular contact ball bearings

Angular contact ball bearings are suitable for applications which require high accuracy and good high-speed performance. This type of bearing is designed to carry a combined load.

- Single-row angular contact ball bearings and matched pair angular contact ball bearings

- The standard contact angles are 15°, 30° and 40°.

They are identified, respectively, by the supplementary codes "C", "A" (omitted) and "B". Bearings with a smaller contact angle are more suitable for applications involving high-speed rotation. Those with a larger contact angle feature superior axial load resistance.

Contact angle

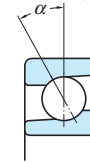

- Angular contact ball bearings are often preloaded to enhance their rigidity and rotating performance.

(refer to p. A 106.)

For high-precision matched pair angular contact ball bearings of class 5 or higher, which are used in machine tools and other precision equipment, the standard preload is specified in three levels: slight (S), light (L), medium (M) and heavy (H). (refer to Table 11-2 on p. A 108.)

- When this type of bearing is loaded radially, an axial component of force is produced. In this case, two bearings are used together facing one another, or two or more bearings are matched and used. (refer to p. A 34.)
- Tables 1 and 2 list the different types of single-row and matched pair/stack angular contact ball bearings and describe their characteristics.

- Double-row angular contact ball bearings

Consist of two single-row angular contact ball bearings matched back-to-back, with inner and outer rings integrated.

Table 3 shows major types and their characteristics.

- Four-point contact ball bearings

- Have a contact angle of 35° and an inner ring divided into two annular pieces. They are suitable for applications that involve either axial loading or combined loading, where the axial load makes up the major part of the load.

- Able to support both axial load and a certain degree of radial load. Each rolling element is in contact with each of the inner and outer rings at a single point, and both contact points lie on the contact angle line. The line runs to either the right or left depending on the direction of the axial load.

Single-row angular contact ball bearings



Bore diameter 10 – 380 mm

Matched pair angular contact ball bearings

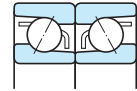

Bore diameter 10 – 380 mm

Double-row angular contact ball bearings



Bore diameter 10 – 110 mm

Four-point contact ball bearings



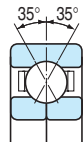

Bore diameter 20 – 110 mm



- Consult with JTEKT when using the four-point contact ball bearing because application conditions such as load magnitude should be examined carefully.



Table 1 Single-row angular contact ball bearings

<p>Standard type</p>  <p>(with pressed cage)</p>  <p>(with machined cage)</p>	<ul style="list-style-type: none"> Single-row angular contact ball bearings accommodate radial load and axial load in one direction. Bearings with a machined cage are suitable for high-speed applications.
<p>HAR type for high-speed applications</p> 	<ul style="list-style-type: none"> Compared with the standard type, this type has more balls that are smaller in diameter and are often used in machine tool spindles. For details, see the separately issued catalog for high ability bearings, CAT No.B2006 for High Ability Ball Bearing Series Angular Contact Ball Bearings for Machining Tools.

Reference G-type bearing

"G-type" bearings have a stand-out between the inner ring and outer ring on both sides that are equal in size. This arrangement is called "flush ground processing." These bearings can be matched in a variety of ways.

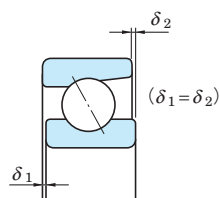
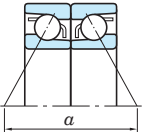
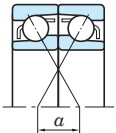
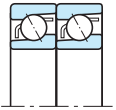

Table 2 Matched pair and stack angular contact ball bearings

<p>Back-to-back arrangement (DB)</p> 	<ul style="list-style-type: none"> Carries radial load and axial load in both directions. Suitable for applications involving moment loading because the distance between the load centers (a) is long. As for the preloaded type, the clearance is pre-adjusted so that bearings will be preloaded the proper amount when the inner ring is fixed with a nut.
<p>Face-to-face arrangement (DF)</p> 	<ul style="list-style-type: none"> Carries radial load and axial load in both directions. Has a smaller moment load accommodating capacity than the back-to-back arrangement, because the distance between the load centers (a) is shorter. As for the preloaded type, the clearance is pre-adjusted so that bearings will be preloaded the proper amount when the outer rings are pressed together.
<p>Tandem arrangement (DT)</p> 	<ul style="list-style-type: none"> Carries radial load and axial load in one direction. Suitable for applications which involve a high degree of axial loading.

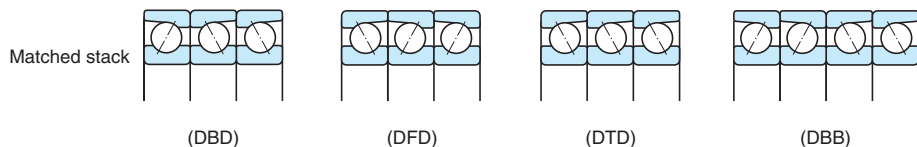
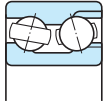
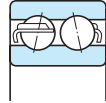
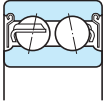
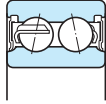

Table 3 Double-row angular contact ball bearings

 <p>(with filling slot) 32, 33</p>	 <p>(without filling slot) 52, 53</p>	<ul style="list-style-type: none"> Accommodates radial load and axial load in both directions. Also able to accommodate moment load. When installing bearings with filling slot (32 and 33 series), the raceway side without filling slot must accommodate main load. The 32 and 33 series are provided with a filling slot, while the 52 and 53 series are not. 32 and 33 series : contact angle 32° 52 and 53 series : contact angle 24° Inferior to single-row and matched pair angular contact ball bearings in terms of high-speed and high accuracy performance. Shielded or sealed 52 and 53 series bearings are also available.
 <p>Shielded 52...ZZ, 53...ZZ</p>	 <p>Sealed 52...2RS, 53...2RS</p>	

Boundary dimensions	The dimensions of standard series are as specified in JIS B 1512.					
Tolerances	<p>As specified in JIS B 1514-1. (refer to Table 7-3 on pp. A 54 – A 57.)</p> <p>JTEKT has established "special tolerances" for bore diameter and outside diameter, as listed in the table to the right, to make it easy to produce high-precision matched stack bearings. Bearings which are produced based on these tolerances are identified by the supplementary code "K5."</p>					
	Special tolerances (K5) Unit : μm					
	Nominal bore diameter d (mm)	Single plane mean bore diameter (Δd_{mp}) or single plane mean outside diameter deviation (ΔD_{mp})				
		class 5		class 4		
	over	up to	upper	lower	upper	lower
	–	50	– 1	– 4	– 1	– 3
	50	80	– 1	– 5	– 1	– 4
	80	120	– 1	– 5	– 1	– 4
Internal clearance	<ul style="list-style-type: none"> Matched pair bearing axial internal clearance.....(refer to Table 10-4 on p. A 97.) Double-row bearing radial internal clearance.....(refer to Table 10-5 on p. A 98.) 					
Recommended fits	<ul style="list-style-type: none"> Classes 0 and 6 bearings.....(refer to Table 9-4 on pp. A 85, 86.) Classes 5 and 4 bearings.....as listed in the table below. 					
	Fit		class 5		class 4	
			Tolerance class			
With shaft	Inner ring rotation	Outer ring rotation	js 5	js 4		
			h 5	h 4		
With housing	Fixed side	Free side	JS 6	JS 5		
			H 6	H 5		
	Outer ring rotation	M 5	M 4			
	<ul style="list-style-type: none"> Refer to Table 11-3 on page A 109 for the recommended fits of high-precision matched pair bearings (class 5 and class 4), which are used with light preload (L) or middle preload (M). 					

Standard cages	<ul style="list-style-type: none"> Pressed steel cage (supplementary code : //) Copper alloy machined cage (supplementary code : FY) <p>[Note] Machine tools are generally equipped with bearings that have a phenolic resin machined cage (FT). Bearings with a polyamide molded cage can also be used depending on the applications. Four-point contact ball bearings usually use a copper alloy machined cage.</p>	Application of standard cages		
		Bearing series	Pressed cage	Machined cage
		79C 79CPA	— —	7900C – 7932C 7900CPA – 7932CPA
		70 70B 70C 70CPA	— — — —	7000 – 7040 7000B – 7040B 7000C – 7040C 7000CPA – 7034CPA
		72 72B 72C 72CPA	7200 – 7220 7200B – 7220B 7200C – 7220C —	7200 – 7240 7200B – 7240B 7200C – 7240C 7200CPA – 7230CPA
		73 73B 73C	7300 – 7320 7303B – 7320B 7303C – 7320C	7300 – 7340 7303B – 7340B 7303C – 7334C
		74 74B	7405 – 7409 7405B – 7409B	7404 – 7418 7404B – 7418B
		HAR9C HAR0C	— —	HAR910C – HAR934C HAR006C – HAR034C
		32 33	3200 – 3215 3302 – 3313	3216 – 3222 3314 – 3322
		52 53	5203 – 5214 5304 – 5315	— —

Allowable misalignment Single-row.....0.000 6 rad (2') : Matched pair, double-row.....misalignment not allowed

Equivalent radial load [Single-row and matched pair angular contact ball bearings]	Dynamic equivalent radial load $P_r = XF_r + YF_a$	Contact angle	$i f_0 F_a^*$	e	Single-row and tandem arrangement				Back-to-back and face-to-face arrangement			
					$F_a/F_r \leq e$		$F_a/F_r > e$		$F_a/F_r \leq e$		$F_a/F_r > e$	
			C_{0r}		X	Y	X	Y	X	Y	X	Y
		15°	0.178 0.357 0.714 1.07 1.43 2.14 3.57 5.35 7.14	0.38 0.40 0.43 0.46 0.47 0.50 0.55 0.56 0.56	1 0 0.44	1 0	1.47 1.40 1.30 1.23 1.19 1.12 1.02 1.00 1.00	1 0.44	1.65 1.57 1.46 1.38 1.34 1.26 1.14 1.12 1.12	1 0.72	2.39 2.28 2.11 2.00 1.93 1.82 1.66 1.63 1.63	1.24
		30°	—	0.80	1	0	0.39	0.76	1	0.78	0.63	1.24
		40°	—	1.14	1	0	0.35	0.57	1	0.55	0.57	0.93

* For i , use 2 for DB&DF and 1 for single&DT. Factor f_0 is shown in the bearing dimension table.

Contact angle	Single-row and tandem arrangement		Back-to-back and face-to-face arrangement	
	X_0	Y_0	X_0	Y_0
15°	0.5	0.46	1	0.92
30°	0.5	0.33	1	0.66
40°	0.5	0.26	1	0.52

In reference to single-row and tandem arrangement bearings, when $P_{0r} < F_r$, $P_{0r} = F_r$

Equivalent radial load [Double-row angular contact ball bearings]	Dynamic equivalent radial load $P_r = XF_r + YF_a$	Contact angle	e	$F_a/F_r \leq e$		$F_a/F_r > e$		(reference)
				X	Y	X	Y	
		24°	0.66	1	0.95	0.68	1.45	52, 53 series
		32°	0.86	1	0.73	0.62	1.17	32, 33 series
	Static equivalent radial load $P_{0r} = X_0 F_r + Y_0 F_a$	Contact angle	X_0	Y_0	(reference)			
		24°	1	0.78	52, 53 series			
		32°	1	0.63	32, 33 series			

[Note] In angular contact ball bearings, slippage occurs between the balls and raceways under too small a load, causing smearing to develop. Matched pair bearings may develop smearing when the ratio of the axial load to the radial load exceeds the value of e ($F_a / F_r > e$), as listed in the specification table. Consult with JTEKT when these bearings are used under the above conditions.

[Reference] Relationship between axial load and axial displacement

Diagrams (1) to (9) illustrate the relationship between axial load and axial displacement.

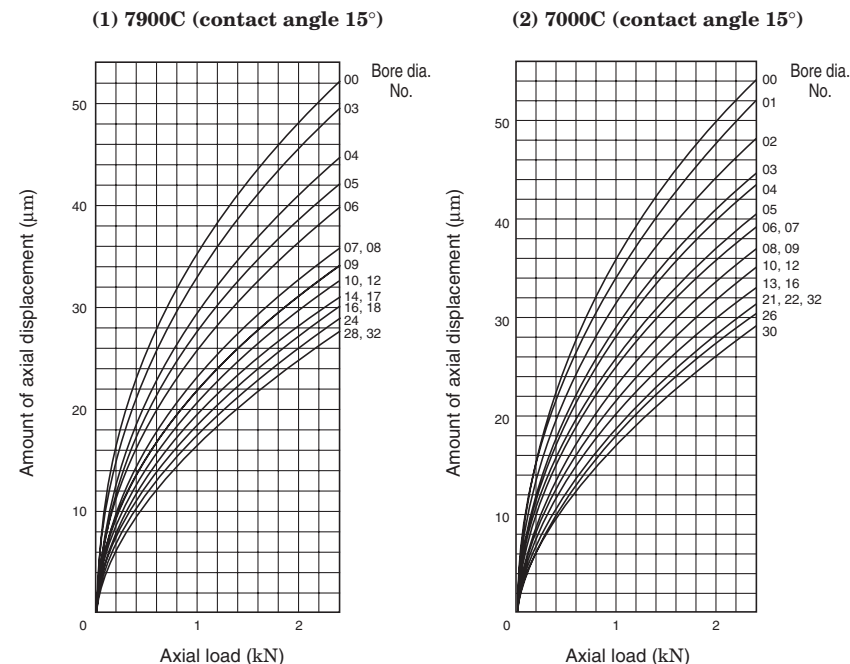

(3) 7200C (contact angle 15°)

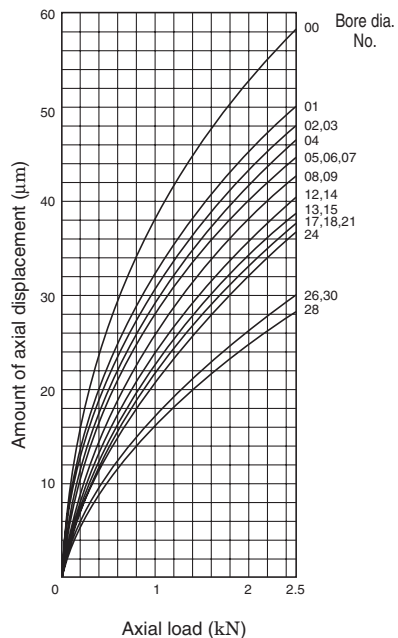

(6) 7000B (contact angle 40°)

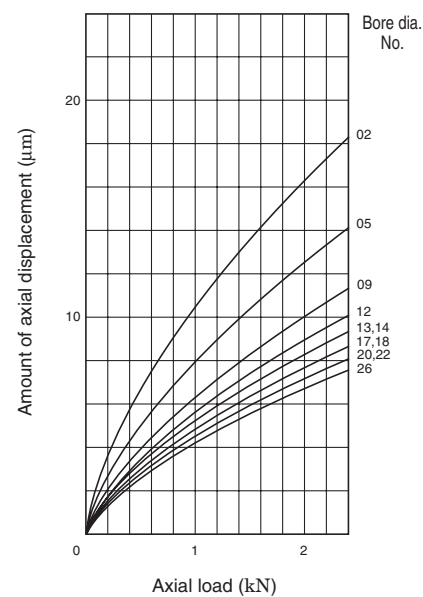

(7) 7200B (contact angle 40°)

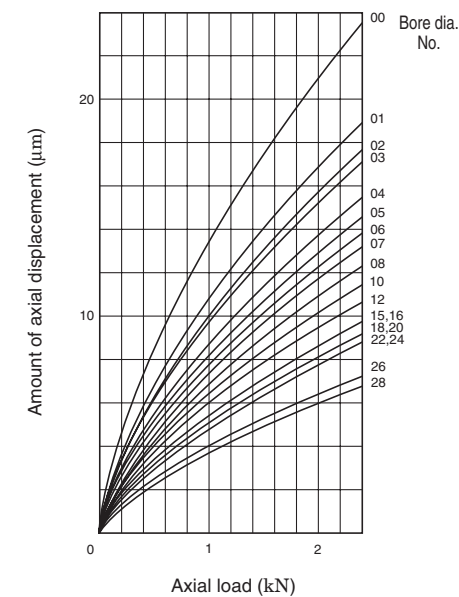

(4) 7000 (contact angle 30°)

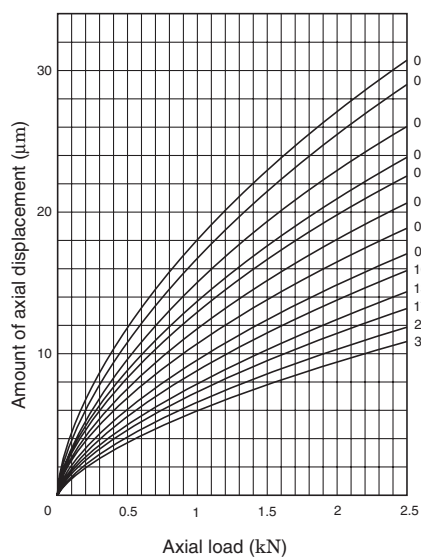

(5) 7200 (contact angle 30°)

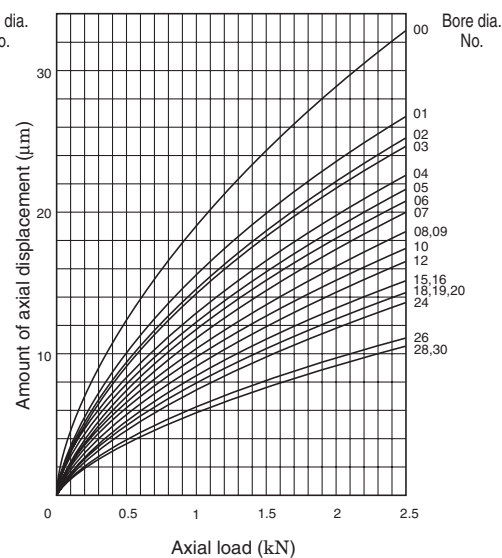

(8) HAR900C (contact angle 15°)

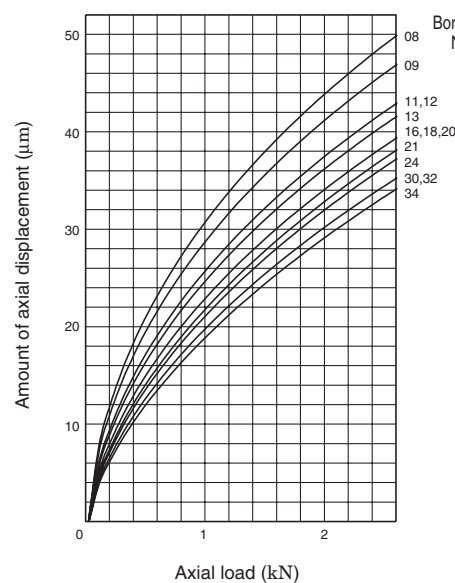

(9) HAR000C (contact angle 15°)

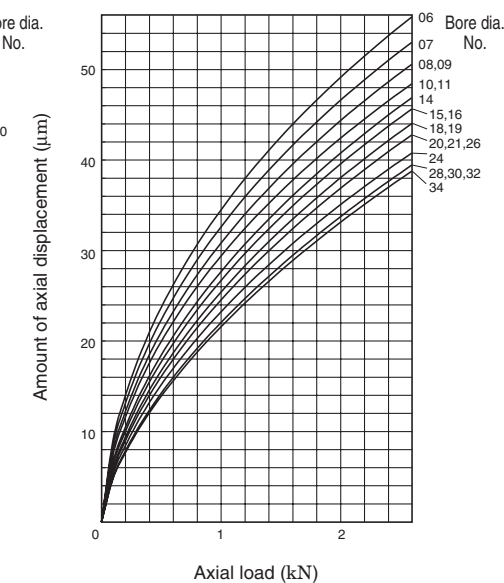

Single-row angular contact ball bearings

d 10 ~ (17) mm

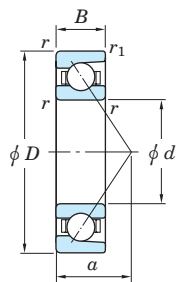

With machined cage

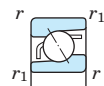

With pressed cage



HAR

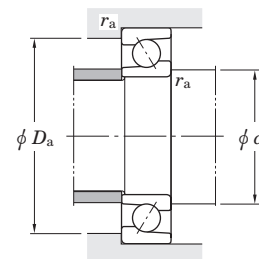

Boundary dimensions (mm)					Basic load ratings (kN)				Factor f_0	Limiting speeds ¹⁾ (min ⁻¹)		Bearing No. ²⁾	Load center (mm) a	Mounting dimensions (mm)			(Refer.) Mass (kg)
d	D	B	$r_{min.}$	$r_{1min.}$	With machined cage		With pressed cage			Grease lub.	Oil lub.			d_a min.	D_a max.	r_a max.	
10	22	6	0.3	0.15	3.00	1.50	—	—	14.2	52 000	69 000	7900C	5.1	12.5	19.5	0.3	0.008
	26	8	0.3	0.15	5.00	2.35	—	—	—	34 000	42 000	7000	9.1	12.5	23.5	0.3	0.021
	26	8	0.3	0.15	4.65	2.15	—	—	—	25 000	33 000	7000B	11.6	12.5	23.5	0.3	0.021
	26	8	0.3	0.15	5.30	2.45	—	—	12.5	47 000	62 000	7000C	6.4	12.5	23.5	0.3	0.021
	30	9	0.6	0.3	4.65	2.20	5.40	2.75	—	29 000	37 000	7200	10.4	14.5	25.5	0.6	0.031
	30	9	0.6	0.3	4.30	2.00	4.95	2.50	—	22 000	29 000	7200B	13.1	14.5	25.5	0.6	0.031
	30	9	0.6	0.3	5.00	2.35	5.80	2.95	13.4	40 000	54 000	7200C	7.2	14.5	25.5	0.6	0.031
	35	11	0.6	0.3	8.50	3.75	9.30	4.30	—	27 000	33 000	7300	12.0	14.5	30.5	0.6	0.054
12	24	6	0.3	0.15	3.20	1.70	—	—	14.7	48 000	62 000	7901C	5.4	14.5	21.5	0.3	0.010
	28	8	0.3	0.15	5.40	2.75	—	—	—	29 000	37 000	7001	9.9	14.5	25.5	0.3	0.024
	28	8	0.3	0.15	4.95	2.50	—	—	—	22 000	29 000	7001B	12.6	14.5	25.5	0.3	0.024
	28	8	0.3	0.15	5.80	2.95	—	—	13.4	40 000	54 000	7001C	6.7	14.5	25.5	0.3	0.024
	32	10	0.6	0.3	7.45	3.65	8.00	4.05	—	27 000	34 000	7201	11.4	16.5	27.5	0.6	0.038
	32	10	0.6	0.3	6.95	3.40	7.40	3.75	—	20 000	27 000	7201B	14.2	16.5	27.5	0.6	0.038
	32	10	0.6	0.3	7.90	3.85	8.50	4.30	12.5	38 000	50 000	7201C	7.9	16.5	27.5	0.6	0.038
	37	12	1	0.6	10.2	4.60	11.2	5.25	—	24 000	31 000	7301	13.1	17.5	31.5	1	0.065
15	28	7	0.3	0.15	4.75	2.65	—	—	14.5	39 000	52 000	7902C	6.4	17.5	25.5	0.3	0.015
	32	9	0.3	0.15	6.10	3.45	—	—	—	26 000	32 000	7002	11.3	17.5	29.5	0.3	0.035
	32	9	0.3	0.15	5.55	3.15	—	—	—	19 000	25 000	7002B	14.6	17.5	29.5	0.3	0.035
	32	9	0.3	0.15	6.60	3.70	—	—	14.1	35 000	47 000	7002C	7.6	17.5	29.5	0.3	0.035
	35	11	0.6	0.3	8.10	4.25	8.10	4.25	—	24 000	29 000	7202	12.9	19.5	30.5	0.6	0.048
	35	11	0.6	0.3	7.45	3.95	7.45	3.95	—	18 000	24 000	7202B	16.2	19.5	30.5	0.6	0.048
	35	11	0.6	0.3	8.65	4.55	8.65	4.55	13.3	33 000	43 000	7202C	8.9	19.5	30.5	0.6	0.048
	42	13	1	0.6	12.5	6.45	13.4	7.20	—	20 000	25 000	7302	15.0	20.5	36.5	1	0.088
17	30	7	0.3	0.15	5.00	2.95	—	—	14.9	36 000	47 000	7903C	6.7	19.5	27.5	0.3	0.016
	35	10	0.3	0.15	6.75	4.15	—	—	—	23 000	28 000	7003	12.7	19.5	32.5	0.3	0.045

[Notes] 1) Limiting speeds shown above are applicable to machined cage bearings.
Limiting speeds of pressed cage bearings should be kept to under 80% of this value.
For bearings with 15° contact angle, this figure is applied to the high precision bearings ranked higher than class 5, used with machined cage or molded cage.

2) B, C or no indication after the bearing number indicates nominal contact angle of 40°, 15° and 30° respectively.
[Remark] Standard cage types used for the above bearings are described earlier in this section.

Single-row angular contact ball bearings

d (17) ~ (25) mm

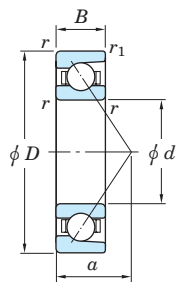

With machined cage

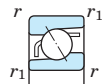

With pressed cage

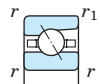

HAR

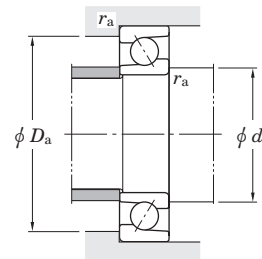

Boundary dimensions (mm)					Basic load ratings (kN)				Factor	Limiting speeds ¹⁾ (min ⁻¹)		Bearing No. ²⁾	Load center (mm) α	Mounting dimensions (mm)			(Refer.) Mass (kg)	
d	D	B	$r_{min.}$	$r_{1min.}$	With machined cage		With pressed cage			Grease lub.	Oil lub.			d_a min.	D_a max.	r_a max.		
17	35	10	0.3	0.15	6.10	3.75	—	—	—	17 000	23 000	7003B	16.1	19.5	32.5	0.3	0.045	
	35	10	0.3	0.15	7.30	4.45	—	—	14.6	31 000	41 000	7003C	8.6	19.5	32.5	0.3	0.045	
	40	12	0.6	0.3	10.2	5.50	10.2	5.50	—	21 000	26 000	7203	14.4	21.5	35.5	0.6	0.070	
	40	12	0.6	0.3	9.35	5.05	9.35	5.05	—	16 000	21 000	7203B	18.2	21.5	35.5	0.6	0.070	
	40	12	0.6	0.3	10.9	5.90	10.9	5.90	13.4	29 000	38 000	7203C	9.9	21.5	35.5	0.6	0.070	
	47	14	1	0.6	14.9	7.90	16.0	8.75	—	18 000	23 000	7303	16.5	22.5	41.5	1	0.120	
	47	14	1	0.6	13.8	7.30	14.8	8.10	—	14 000	18 000	7303B	20.8	22.5	41.5	1	0.120	
	47	14	1	0.6	15.8	8.40	15.8	8.40	12.6	25 000	33 000	7303C	11.4	22.5	41.5	1	0.120	
20	37	9	0.3	0.15	7.30	4.55	—	—	14.9	30 000	39 000	7904C	8.3	22.5	34.5	0.3	0.035	
	42	12	0.6	0.3	10.3	6.10	—	—	—	19 000	24 000	7004	15.1	24.5	37.5	0.6	0.079	
	42	12	0.6	0.3	9.35	5.55	—	—	—	14 000	19 000	7004B	19.2	24.5	37.5	0.6	0.079	
	42	12	0.6	0.3	11.1	6.60	—	—	14.1	26 000	35 000	7004C	10.2	24.5	37.5	0.6	0.079	
	47	14	1	0.6	14.5	8.40	15.4	9.15	—	17 000	22 000	7204	17.0	25.5	41.5	1	0.112	
	47	14	1	0.6	13.3	7.70	14.1	8.40	—	13 000	17 000	7204B	21.5	25.5	41.5	1	0.112	
	47	14	1	0.6	15.5	9.00	16.5	9.80	13.4	24 000	32 000	7204C	11.6	25.5	41.5	1	0.112	
	52	15	1.1	0.6	17.4	9.40	18.7	10.4	—	17 000	21 000	7304	17.9	27	45	1	0.150	
	52	15	1.1	0.6	16.2	8.70	17.3	9.65	—	13 000	17 000	7304B	22.6	27	45	1	0.150	
	52	15	1.1	0.6	18.5	9.95	19.9	11.1	12.6	23 000	31 000	7304C	12.3	27	45	1	0.150	
	72	19	1.1	0.6	35.6	19.1	—	—	—	9 600	13 000	7404	23.1	27	65	1	0.395	
	72	19	1.1	0.6	33.5	17.9	—	—	—	8 500	12 000	7404B	29.2	27	65	1	0.395	
	25	42	9	0.3	0.15	7.80	5.45	—	—	15.5	25 000	33 000	7905C	9.1	27.5	39.5	0.3	0.041
		47	12	0.6	0.3	11.3	7.40	—	—	—	17 000	21 000	7005	16.4	29.5	42.5	0.6	0.091
47		12	0.6	0.3	10.2	6.70	—	—	—	12 000	17 000	7005B	21.1	29.5	42.5	0.6	0.091	
47		12	0.6	0.3	12.3	8.00	—	—	14.7	23 000	30 000	7005C	10.8	29.5	42.5	0.6	0.091	
52		15	1	0.6	15.3	9.50	16.2	10.3	—	15 000	19 000	7205	18.8	30.5	46.5	1	0.135	
52		15	1	0.6	14.0	8.70	14.7	9.40	—	12 000	15 000	7205B	23.9	30.5	46.5	1	0.135	
52		15	1	0.6	16.6	10.2	17.5	11.1	14.0	21 000	28 000	7205C	12.7	30.5	46.5	1	0.135	

[Notes] 1) Limiting speeds shown above are applicable to machined cage bearings.
 Limiting speeds of pressed cage bearings should be kept to under 80% of this value.
 For bearings with 15° contact angle, this figure is applied to the high precision bearings ranked higher than class 5, used with machined cage or molded cage.

2) B, C or no indication after the bearing number indicates nominal contact angle of 40°, 15° and 30° respectively.
 [Remark] Standard cage types used for the above bearings are described earlier in this section.

Single-row angular contact ball bearings

d (25) ~ (35) mm

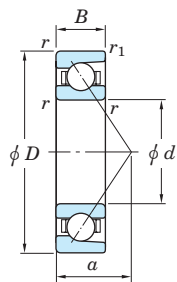

With machined cage

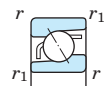

With pressed cage



HAR

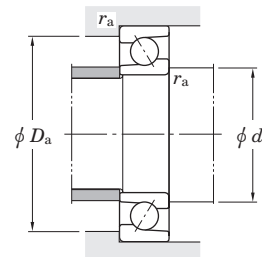

Boundary dimensions (mm)					Basic load ratings (kN)				Factor	Limiting speeds ¹⁾ (min ⁻¹)		Bearing No. ²⁾	Load center (mm) α	Mounting dimensions (mm)			(Refer.) Mass (kg)
d	D	B	r min.	r1 min.	With machined cage		With pressed cage			Grease lub.	Oil lub.			da min.	Da max.	ra max.	
25	62	17	1.1	0.6	24.8	14.4	26.4	15.8	—	14 000	17 000	7305	21.1	32	55	1	0.243
	62	17	1.1	0.6	22.9	13.3	24.4	14.6	—	10 000	14 000	7305B	26.8	32	55	1	0.243
	62	17	1.1	0.6	26.4	15.3	28.1	16.8	12.8	19 000	25 000	7305C	14.3	32	55	1	0.243
	80	21	1.5	1	39.7	23.2	42.6	25.7	—	8 200	11 000	7405	26.4	33.5	71.5	1.5	0.527
	80	21	1.5	1	36.9	21.5	39.6	23.9	—	7 300	10 000	7405B	33.6	33.5	71.5	1.5	0.527
30	47	9	0.3	0.15	8.30	6.25	—	—	15.9	22 000	29 000	7906C	9.7	32.5	44.5	0.3	0.046
	55	13	1	0.6	8.70	4.85	—	—	7.9	26 000	40 000	HAR006C	12.2	35.5	49.5	1	0.116
	55	13	1	0.6	14.5	10.1	—	—	—	14 000	18 000	7006	18.8	35.5	49.5	1	0.133
	55	13	1	0.6	13.1	9.20	—	—	—	11 000	14 000	7006B	24.3	35.5	49.5	1	0.133
	55	13	1	0.6	15.8	11.0	—	—	14.9	20 000	26 000	7006C	12.2	35.5	49.5	1	0.133
	62	16	1	0.6	21.3	13.7	22.5	14.8	—	13 000	16 000	7206	21.5	35.5	56.5	1	0.208
	62	16	1	0.6	19.4	12.5	20.5	13.6	—	9 600	13 000	7206B	27.6	35.5	56.5	1	0.208
	62	16	1	0.6	23.0	14.7	24.3	16.0	14.0	18 000	24 000	7206C	14.3	35.5	56.5	1	0.208
	72	19	1.1	0.6	30.1	18.9	31.9	20.6	—	12 000	14 000	7306	24.5	37	65	1	0.362
	72	19	1.1	0.6	27.6	17.4	29.3	19.0	—	8 700	12 000	7306B	31.3	37	65	1	0.362
	72	19	1.1	0.6	32.3	20.3	34.2	22.1	13.4	16 000	21 000	7306C	16.5	37	65	1	0.362
	90	23	1.5	1	47.6	28.4	51.0	31.6	—	7 300	9 700	7406	29.3	38.5	81.5	1.5	0.686
	90	23	1.5	1	44.2	26.4	47.4	29.3	—	6 500	8 900	7406B	37.3	38.5	81.5	1.5	0.686
35	55	10	0.6	0.3	12.5	9.70	—	—	15.7	19 000	25 000	7907C	11.0	39.5	50.5	0.6	0.074
	62	14	1	0.6	9.25	5.55	—	—	8.1	23 000	35 000	HAR007C	13.5	40.5	56.5	1	0.158
	62	14	1	0.6	17.5	12.6	—	—	—	12 000	15 000	7007	21.2	40.5	56.5	1	0.170
	62	14	1	0.6	15.8	11.4	—	—	—	9 200	12 000	7007B	27.6	40.5	56.5	1	0.170
	62	14	1	0.6	19.1	13.7	—	—	15.0	17 000	22 000	7007C	13.5	40.5	56.5	1	0.170
	72	17	1.1	0.6	28.1	18.6	29.7	20.2	—	11 000	14 000	7207	24.2	42	65	1	0.295
	72	17	1.1	0.6	25.6	17.0	27.0	18.5	—	8 300	11 000	7207B	31.4	42	65	1	0.295
	72	17	1.1	0.6	30.4	20.1	32.1	21.7	14.0	15 000	20 000	7207C	15.8	42	65	1	0.295
	80	21	1.5	1	35.4	22.0	39.9	26.4	—	10 000	13 000	7307	27.4	43.5	71.5	1.5	0.475

[Notes] 1) Limiting speeds shown above are applicable to machined cage bearings. Limiting speeds of pressed cage bearings should be kept to under 80% of this value. For bearings with 15° contact angle, this figure is applied to the high precision bearings ranked higher than class 5, used with machined cage or molded cage.

2) B, C or no indication after the bearing number indicates nominal contact angle of 40°, 15° and 30° respectively. [Remark] Standard cage types used for the above bearings are described earlier in this section.

Single-row angular contact ball bearings

d (35) ~ (45) mm

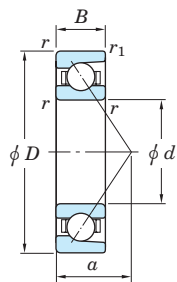

With machined cage

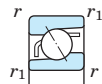

With pressed cage



HAR

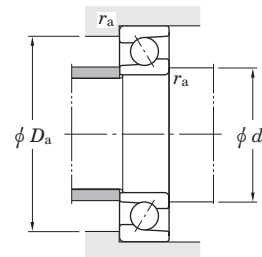

Boundary dimensions (mm)					Basic load ratings (kN)				Factor	Limiting speeds ¹⁾ (min ⁻¹)		Bearing No. ²⁾	Load center (mm) α	Mounting dimensions (mm)			(Refer.) Mass (kg)
d	D	B	r min.	r1 min.	With machined cage		With pressed cage			Grease lub.	Oil lub.			da min.	Da max.	ra max.	
35	80	21	1.5	1	32.5	20.2	36.6	24.3	—	7 700	10 000	7307B	35.0	43.5	71.5	1.5	0.475
	80	21	1.5	1	37.9	23.6	42.8	28.3	13.4	14 000	19 000	7307C	18.3	43.5	71.5	1.5	0.475
	100	25	1.5	1	60.4	37.0	64.8	41.1	—	6 500	8 600	7407	32.6	43.5	91.5	1.5	0.950
	100	25	1.5	1	56.2	34.3	60.2	38.1	—	5 700	7 900	7407B	41.7	43.5	91.5	1.5	0.950
40	62	12	0.6	0.3	15.7	12.4	—	—	15.7	17 000	22 000	7908C	12.8	44.5	57.5	0.6	0.107
	62	12	0.6	0.3	6.35	4.05	—	—	8.4	22 000	33 000	HAR908C	12.8	44.5	57.5	0.6	0.115
	68	15	1	0.6	9.70	6.20	—	—	8.2	20 000	31 000	HAR008C	14.7	45.5	62.5	1	0.200
	68	15	1	0.6	18.7	14.6	—	—	—	11 000	14 000	7008	23.2	45.5	62.5	1	0.210
	68	15	1	0.6	16.8	13.2	—	—	—	8 300	11 000	7008B	30.2	45.5	62.5	1	0.210
	68	15	1	0.6	20.5	15.9	—	—	15.4	15 000	20 000	7008C	14.8	45.5	62.5	1	0.210
	80	18	1.1	0.6	33.6	23.3	35.3	25.1	—	10 000	12 000	7208	26.3	47	73	1	0.382
	80	18	1.1	0.6	30.6	21.3	32.1	23.0	—	7 500	10 000	7208B	34.2	47	73	1	0.382
	80	18	1.1	0.6	36.4	25.2	38.2	27.1	14.2	14 000	18 000	7208C	17.0	47	73	1	0.382
	90	23	1.5	1	43.2	27.4	48.8	32.9	—	9 200	12 000	7308	30.3	48.5	81.5	1.5	0.657
	90	23	1.5	1	39.7	25.2	44.8	30.3	—	6 900	9 200	7308B	38.8	48.5	81.5	1.5	0.657
	90	23	1.5	1	46.3	29.4	52.3	35.3	13.4	13 000	17 000	7308C	20.2	48.5	81.5	1.5	0.657
110	27	2	1	69.9	43.5	75.0	48.4	—	5 900	7 900	7408	35.5	50	100	2	1.23	
110	27	2	1	64.9	40.4	69.6	44.9	—	5 200	7 200	7408B	45.4	50	100	2	1.23	
45	68	12	0.6	0.3	16.6	14.1	—	—	16.0	15 000	20 000	7909C	13.6	49.5	63.5	0.6	0.127
	68	12	0.6	0.3	6.80	4.70	—	—	8.5	19 000	30 000	HAR909C	13.6	49.5	63.5	0.6	0.136
	75	16	1	0.6	10.9	7.10	—	—	8.3	18 000	28 000	HAR009C	16.0	50.5	69.5	1	0.251
	75	16	1	0.6	22.2	17.7	—	—	—	10 000	12 000	7009	25.3	50.5	69.5	1	0.260
	75	16	1	0.6	20.0	16.0	—	—	—	7 500	10 000	7009B	33.2	50.5	69.5	1	0.260
	75	16	1	0.6	24.4	19.3	—	—	15.4	14 000	18 000	7009C	16.0	50.5	69.5	1	0.260
	85	19	1.1	0.6	37.7	26.6	39.6	28.6	—	9 400	12 000	7209	28.0	52	78	1	0.430
	85	19	1.1	0.6	34.3	24.3	36.1	26.1	—	7 000	9 400	7209B	36.4	52	78	1	0.430
	85	19	1.1	0.6	40.8	28.7	42.9	30.9	14.2	13 000	17 000	7209C	18.1	52	78	1	0.430

[Notes] 1) Limiting speeds shown above are applicable to machined cage bearings. Limiting speeds of pressed cage bearings should be kept to under 80% of this value. For bearings with 15° contact angle, this figure is applied to the high precision bearings ranked higher than class 5, used with machined cage or molded cage.

2) B, C or no indication after the bearing number indicates nominal contact angle of 40°, 15° and 30° respectively.

[Remark] Standard cage types used for the above bearings are described earlier in this section.

Single-row angular contact ball bearings

d (45) ~ (55) mm

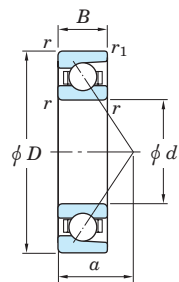

With machined cage

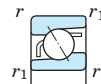

With pressed cage



HAR

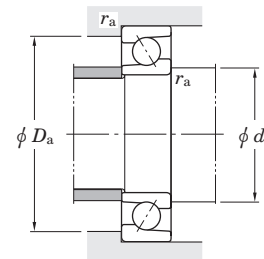

Boundary dimensions (mm)					Basic load ratings (kN)				Factor	Limiting speeds ¹⁾ (min ⁻¹)		Bearing No. ²⁾	Load center (mm) α	Mounting dimensions (mm)			(Refer.) Mass (kg)
d	D	B	r _{min.}	r _{1 min.}	With machined cage		With pressed cage			Grease lub.	Oil lub.			d _{a min.}	D _{a max.}	r _{a max.}	
45	100	25	1.5	1	55.1	37.1	58.4	40.4	—	8 200	10 000	7309	33.6	53.5	91.5	1.5	0.875
	100	25	1.5	1	50.6	34.1	53.6	37.2	—	6 200	8 200	7309B	43.1	53.5	91.5	1.5	0.875
	100	25	1.5	1	59.2	39.7	62.7	43.4	13.5	11 000	15 000	7309C	22.3	53.5	91.5	1.5	0.875
	120	29	2	1	84.9	53.8	91.1	59.8	—	5 400	7 100	7409	38.6	55	110	2	1.55
	120	29	2	1	78.9	50.0	84.7	55.5	—	4 800	6 600	7409B	49.5	55	110	2	1.55
50	72	12	0.6	0.3	17.4	15.7	—	—	16.2	14 000	18 000	7910C	14.2	54.5	67.5	0.6	0.128
	72	12	0.6	0.3	9.10	6.30	—	—	8.5	18 000	28 000	HAR910C	14.2	54.5	67.5	0.6	0.131
	80	16	1	0.6	11.4	7.85	—	—	8.4	17 000	26 000	HAR010C	16.7	55.5	74.5	1	0.273
	80	16	1	0.6	23.6	20.1	—	—	—	9 200	11 000	7010	26.9	55.5	74.5	1	0.290
	80	16	1	0.6	21.2	18.1	—	—	—	6 900	9 200	7010B	35.3	55.5	74.5	1	0.290
	80	16	1	0.6	26.0	21.9	—	—	15.7	13 000	17 000	7010C	16.8	55.5	74.5	1	0.290
	90	20	1.1	0.6	39.4	29.4	41.3	31.5	—	8 500	11 000	7210	30.4	57	83	1	0.485
	90	20	1.1	0.6	35.7	26.7	37.4	28.6	—	6 400	8 500	7210B	39.6	57	83	1	0.485
	90	20	1.1	0.6	42.8	31.8	44.8	34.1	14.6	12 000	16 000	7210C	19.4	57	83	1	0.485
	110	27	2	1	70.1	48.1	74.3	52.5	—	7 300	9 100	7310	37.2	60	100	2	1.14
	110	27	2	1	64.4	44.3	68.2	48.3	—	5 500	7 300	7310B	47.9	60	100	2	1.14
	110	27	2	1	75.1	51.6	79.6	56.2	13.4	10 000	13 000	7310C	24.5	60	100	2	1.14
	130	31	2.1	1.1	97.4	65.3	—	—	—	4 900	6 600	7410	41.6	62	118	2	1.92
130	31	2.1	1.1	90.2	60.4	—	—	—	4 400	6 000	7410B	53.5	62	118	2	1.92	
55	80	13	1	0.6	19.7	18.5	—	—	16.3	13 000	17 000	7911C	15.5	60.5	74.5	1	0.178
	80	13	1	0.6	10.1	7.65	—	—	8.6	16 000	25 000	HAR911C	15.5	60.5	74.5	1	0.189
	90	18	1.1	0.6	14.1	9.90	—	—	8.4	15 000	23 000	HAR011C	18.7	62	83	1	0.403
	90	18	1.1	0.6	31.1	26.3	—	—	—	8 300	10 000	7011	29.9	62	83	1	0.420
	90	18	1.1	0.6	27.9	23.7	—	—	—	6 200	8 300	7011B	39.4	62	83	1	0.420
	90	18	1.1	0.6	34.1	28.6	—	—	15.5	11 000	15 000	7011C	18.7	62	83	1	0.420
	100	21	1.5	1	48.7	37.1	51.0	39.8	—	7 600	9 500	7211	33.3	63.5	91.5	1.5	0.635
	100	21	1.5	1	44.1	33.8	46.2	36.2	—	5 700	7 600	7211B	43.6	63.5	91.5	1.5	0.635

[Notes] 1) Limiting speeds shown above are applicable to machined cage bearings. Limiting speeds of pressed cage bearings should be kept to under 80% of this value. For bearings with 15° contact angle, this figure is applied to the high precision bearings ranked higher than class 5, used with machined cage or molded cage.

2) B, C or no indication after the bearing number indicates nominal contact angle of 40°, 15° and 30° respectively.

[Remark] Standard cage types used for the above bearings are described earlier in this section.

Single-row angular contact ball bearings

d (55) ~ (65) mm

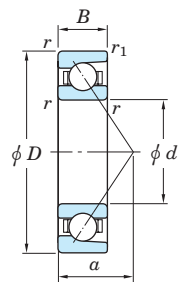

With machined cage

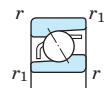

With pressed cage



HAR

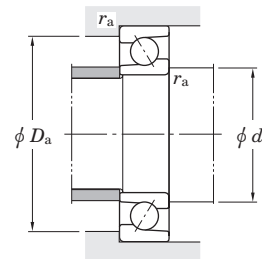

Boundary dimensions (mm)					Basic load ratings (kN)				Factor	Limiting speeds ¹⁾ (min ⁻¹)		Bearing No. ²⁾	Load center (mm) α	Mounting dimensions (mm)			(Refer.) Mass (kg)
d	D	B	r _{min.}	r _{1 min.}	With machined cage		With pressed cage			Grease lub.	Oil lub.			d _{a min.}	D _{a max.}	r _{a max.}	
55	100	21	1.5	1	52.9	40.2	55.4	43.1	14.6	11 000	14 000	7211C	21.1	63.5	91.5	1.5	0.635
	120	29	2	1	80.9	56.5	85.8	61.7	—	6 700	8 400	7311	40.2	65	110	2	1.45
	120	29	2	1	74.3	52.0	78.7	56.7	—	5 000	6 700	7311B	51.8	65	110	2	1.45
	120	29	2	1	86.8	60.6	91.9	66.1	13.4	9 300	12 000	7311C	26.4	65	110	2	1.45
	140	33	2.1	1.1	118	82.4	—	—	—	4 500	6 000	7411	45.0	67	128	2	2.36
	140	33	2.1	1.1	110	76.5	—	—	—	4 000	5 500	7411B	57.8	67	128	2	2.36
60	85	13	1	0.6	23.2	21.8	—	—	16.3	12 000	16 000	7912C	16.3	65.5	79.5	1	0.187
	85	13	1	0.6	9.95	7.75	—	—	8.6	15 000	23 000	HAR912C	16.2	65.5	79.5	1	0.202
	95	18	1.1	0.6	14.7	10.8	—	—	8.5	14 000	22 000	HAR012C	19.4	67	88	1	0.433
	95	18	1.1	0.6	31.9	28.1	—	—	—	7 700	9 700	7012	31.4	67	88	1	0.450
	95	18	1.1	0.6	28.6	25.3	—	—	—	5 800	7 700	7012B	41.5	67	88	1	0.450
	95	18	1.1	0.6	35.0	30.6	—	—	15.7	11 000	14 000	7012C	19.4	67	88	1	0.450
	110	22	1.5	1	58.9	45.7	61.7	49.0	—	6 900	8 600	7212	36.1	68.5	101.5	1.5	0.820
	110	22	1.5	1	53.4	41.6	55.9	44.6	—	5 100	6 900	7212B	47.5	68.5	101.5	1.5	0.820
	110	22	1.5	1	64.0	49.5	67.0	53.0	14.5	9 500	13 000	7212C	22.7	68.5	101.5	1.5	0.820
	130	31	2.1	1.1	92.5	65.6	98.1	71.6	—	6 200	7 700	7312	43.2	72	118	2	1.81
	130	31	2.1	1.1	84.9	60.3	90.0	65.8	—	4 600	6 200	7312B	55.8	72	118	2	1.81
	130	31	2.1	1.1	99.2	70.3	105	76.7	13.4	8 600	11 000	7312C	28.4	72	118	2	1.81
	150	35	2.1	1.1	129	93.6	—	—	—	4 100	5 500	7412	48.5	72	138	2	2.85
	150	35	2.1	1.1	119	86.7	—	—	—	3 700	5 100	7412B	62.6	72	138	2	2.85
65	90	13	1	0.6	20.8	21.2	—	—	16.5	11 000	15 000	7913C	16.9	70.5	84.5	1	0.205
	90	13	1	0.6	11.8	9.45	—	—	8.6	14 000	22 000	HAR913C	16.9	70.5	84.5	1	0.212
	100	18	1.1	0.6	15.3	11.8	—	—	8.5	13 000	21 000	HAR013C	20.1	72	93	1	0.462
	100	18	1.1	0.6	33.7	31.4	—	—	—	7 200	9 000	7013	33.0	72	93	1	0.470
	100	18	1.1	0.6	30.1	28.3	—	—	—	5 400	7 200	7013B	43.8	72	93	1	0.470
	100	18	1.1	0.6	37.1	34.3	—	—	15.9	10 000	13 000	7013C	20.1	72	93	1	0.470
	120	23	1.5	1	67.3	54.2	70.2	57.8	—	6 400	8 000	7213	38.2	73.5	111.5	1.5	1.02

[Notes] 1) Limiting speeds shown above are applicable to machined cage bearings. Limiting speeds of pressed cage bearings should be kept to under 80% of this value. For bearings with 15° contact angle, this figure is applied to the high precision bearings ranked higher than class 5, used with machined cage or molded cage.

2) B, C or no indication after the bearing number indicates nominal contact angle of 40°, 15° and 30° respectively.

[Remark] Standard cage types used for the above bearings are described earlier in this section.

Single-row angular contact ball bearings

d (65) ~ (75) mm

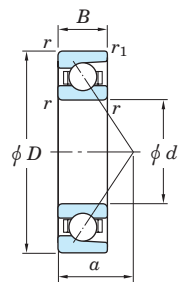

With machined cage

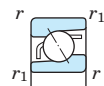

With pressed cage



HAR

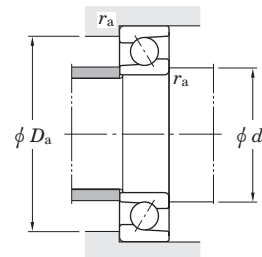

Boundary dimensions (mm)					Basic load ratings (kN)				Factor	Limiting speeds ¹⁾ (min ⁻¹)		Bearing No. ²⁾	Load center (mm) α	Mounting dimensions (mm)			(Refer.) Mass (kg)
d	D	B	r min.	r1 min.	With machined cage		With pressed cage			Grease lub.	Oil lub.			da min.	Da max.	ra max.	
65	120	23	1.5	1	60.9	49.3	63.6	52.6	—	4 800	6 400	7213B	50.3	73.5	111.5	1.5	1.02
	120	23	1.5	1	73.1	58.7	76.3	62.6	14.6	8 900	12 000	7213C	23.9	73.5	111.5	1.5	1.02
	140	33	2.1	1.1	105	75.3	111	82.2	—	5 800	7 200	7313	46.3	77	128	2	2.22
	140	33	2.1	1.1	96.1	69.3	102	75.6	—	4 300	5 800	7313B	59.7	77	128	2	2.22
	140	33	2.1	1.1	112	80.7	119	88.1	13.4	8 000	11 000	7313C	30.3	77	128	2	2.22
	160	37	2.1	1.1	139	104	—	—	—	3 900	5 200	7413	51.4	77	148	2	3.41
	160	37	2.1	1.1	129	96.8	—	—	—	3 500	4 800	7413B	66.3	77	148	2	3.41
70	100	16	1	0.6	28.9	29.0	—	—	16.4	10 000	12 000	7914C	19.4	75.5	94.5	1	0.332
	100	16	1	0.6	12.9	10.5	—	—	8.7	13 000	20 000	HAR914C	19.4	75.5	94.5	1	0.356
	110	20	1.1	0.6	20.7	15.5	—	—	8.4	12 000	19 000	HAR014C	22.1	77	103	1	0.629
	110	20	1.1	0.6	42.7	39.4	—	—	—	6 600	8 300	7014	36.0	77	103	1	0.660
	110	20	1.1	0.6	38.3	35.5	—	—	—	5 000	6 600	7014B	47.8	77	103	1	0.660
	110	20	1.1	0.6	46.9	43.0	—	—	15.7	9 200	12 000	7014C	22.1	77	103	1	0.660
	125	24	1.5	1	69.8	55.6	76.3	63.5	—	6 100	7 600	7214	40.2	78.5	116.5	1.5	1.12
	125	24	1.5	1	63.2	50.6	69.1	57.8	—	4 600	6 100	7214B	52.9	78.5	116.5	1.5	1.12
	125	24	1.5	1	75.9	60.2	83.0	68.8	14.6	8 400	11 000	7214C	25.1	78.5	116.5	1.5	1.12
	150	35	2.1	1.1	118	85.8	125	93.6	—	5 400	6 700	7314	49.3	82	138	2	2.70
	150	35	2.1	1.1	108	78.9	114	86.0	—	4 000	5 400	7314B	63.7	82	138	2	2.70
	150	35	2.1	1.1	126	91.9	134	100	13.4	7 500	9 900	7314C	32.2	82	138	2	2.70
	180	42	3	1.1	149	115	—	—	—	3 500	4 600	7414	57.6	84	166	2.5	4.99
180	42	3	1.1	148	119	—	—	—	3 100	4 300	7414B	74.2	84	166	2.5	4.99	
75	105	16	1	0.6	29.4	30.5	—	—	16.5	9 300	12 000	7915C	20.1	80.5	99.5	1	0.350
	105	16	1	0.6	13.3	11.2	—	—	8.7	12 000	19 000	HAR915C	20.1	80.5	99.5	1	0.370
	115	20	1.1	0.6	21.1	16.2	—	—	8.5	12 000	18 000	HAR015C	22.7	82	108	1	0.665
	115	20	1.1	0.6	43.6	41.7	—	—	—	6 300	7 800	7015	37.4	82	108	1	0.690
	115	20	1.1	0.6	39.1	37.6	—	—	—	4 700	6 300	7015B	49.9	82	108	1	0.690
	115	20	1.1	0.6	48.0	45.6	—	—	15.9	8 700	11 000	7015C	22.7	82	108	1	0.690

[Notes] 1) Limiting speeds shown above are applicable to machined cage bearings. Limiting speeds of pressed cage bearings should be kept to under 80% of this value. For bearings with 15° contact angle, this figure is applied to the high precision bearings ranked higher than class 5, used with machined cage or molded cage.

2) B, C or no indication after the bearing number indicates nominal contact angle of 40°, 15° and 30° respectively.

[Remark] Standard cage types used for the above bearings are described earlier in this section.

Single-row angular contact ball bearings

d (75) ~ (85) mm

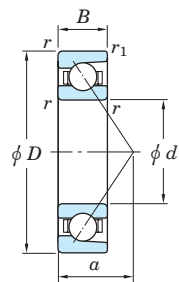

With machined cage

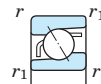

With pressed cage



HAR

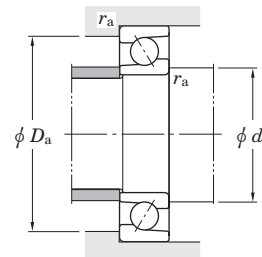

Boundary dimensions (mm)					Basic load ratings (kN)				Factor	Limiting speeds ¹⁾ (min ⁻¹)		Bearing No. ²⁾	Load center (mm) α	Mounting dimensions (mm)			(Refer.) Mass (kg)
d	D	B	r _{min.}	r _{1 min.}	With machined cage		With pressed cage			Grease lub.	Oil lub.			d _{a min.}	D _{a max.}	r _{a max.}	
75	130	25	1.5	1	79.2	65.2	82.7	69.5	—	5 800	7 200	7215	42.1	83.5	121.5	1.5	1.23
	130	25	1.5	1	71.7	59.3	74.9	63.3	—	4 300	5 800	7215B	55.5	83.5	121.5	1.5	1.23
	130	25	1.5	1	86.1	70.6	89.9	75.3	14.6	8 000	11 000	7215C	26.2	83.5	121.5	1.5	1.23
	160	37	2.1	1.1	128	97.0	136	106	—	5 000	6 300	7315	52.4	87	148	2	3.15
	160	37	2.1	1.1	118	89.2	125	97.3	—	3 800	5 000	7315B	67.8	87	148	2	3.15
	160	37	2.1	1.1	137	104	146	113	13.4	7 000	9 200	7315C	34.2	87	148	2	3.15
	190	45	3	1.1	171	141	—	—	—	3 300	4 400	7415	61.3	89	176	2.5	5.90
	190	45	3	1.1	158	131	—	—	—	2 900	4 000	7415B	78.9	89	176	2.5	5.90
80	110	16	1	0.6	29.8	31.6	—	—	16.5	8 800	11 000	7916C	20.7	85.5	104.5	1	0.368
	110	16	1	0.6	13.6	11.9	—	—	8.8	12 000	18 000	HAR916C	20.7	85.5	104.5	1	0.398
	125	22	1.1	0.6	24.7	19.2	—	—	8.4	10 000	16 000	HAR016C	24.7	87	118	1	0.903
	125	22	1.1	0.6	53.4	50.6	—	—	—	5 800	7 200	7016	40.6	87	118	1	0.930
	125	22	1.1	0.6	47.8	45.7	—	—	—	4 300	5 800	7016B	54.0	87	118	1	0.930
	125	22	1.1	0.6	58.7	55.3	—	—	15.7	8 000	11 000	7016C	24.7	87	118	1	0.930
	140	26	2	1	85.3	71.5	89.0	76.2	—	5 400	6 700	7216	44.8	90	130	2	1.50
	140	26	2	1	77.1	65.0	80.5	69.3	—	4 000	5 400	7216B	59.2	90	130	2	1.50
	140	26	2	1	92.8	77.5	96.9	82.7	14.7	7 500	9 900	7216C	27.7	90	130	2	1.50
	170	39	2.1	1.1	139	109	147	119	—	4 700	5 900	7316	55.6	92	158	2	3.85
	170	39	2.1	1.1	127	100	135	109	—	3 500	4 700	7316B	71.9	92	158	2	3.85
	170	39	2.1	1.1	149	117	158	127	13.5	6 500	8 600	7316C	36.2	92	158	2	3.85
	200	48	3	1.1	193	166	—	—	—	3 100	4 100	7416	65.0	94	186	2.5	6.00
	200	48	3	1.1	179	154	—	—	—	2 700	3 800	7416B	83.6	94	186	2.5	6.00
85	120	18	1.1	0.6	38.9	40.6	—	—	16.5	8 100	11 000	7917C	22.7	92	113	1	0.523
	120	18	1.1	0.6	16.3	14.2	—	—	8.7	10 000	16 000	HAR917C	22.7	92	113	1	0.570
	130	22	1.1	0.6	25.1	20.1	—	—	8.5	9 700	15 000	HAR017C	25.4	92	123	1	0.947
	130	22	1.1	0.6	54.6	53.7	—	—	—	5 500	6 800	7017	42.3	92	123	1	0.970
	130	22	1.1	0.6	48.8	48.4	—	—	—	4 100	5 500	7017B	56.5	92	123	1	0.970

[Notes] 1) Limiting speeds shown above are applicable to machined cage bearings. Limiting speeds of pressed cage bearings should be kept to under 80% of this value. For bearings with 15° contact angle, this figure is applied to the high precision bearings ranked higher than class 5, used with machined cage or molded cage.

2) B, C or no indication after the bearing number indicates nominal contact angle of 40°, 15° and 30° respectively.

[Remark] Standard cage types used for the above bearings are described earlier in this section.

Single-row angular contact ball bearings

d (85) ~ (95) mm

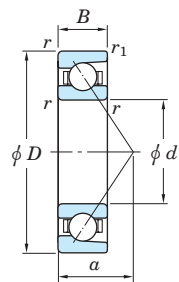

With machined cage

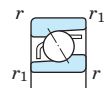

With pressed cage



HAR

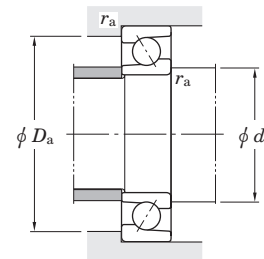

Boundary dimensions (mm)					Basic load ratings (kN)				Factor	Limiting speeds ¹⁾ (min ⁻¹)		Bearing No. ²⁾	Load center (mm) α	Mounting dimensions (mm)			(Refer.) Mass (kg)
d	D	B	r _{min.}	r _{1 min.}	With machined cage		With pressed cage			Grease lub.	Oil lub.			d _{a min.}	D _{a max.}	r _{a max.}	
					C _r	C _{0r}	C _r	C _{0r}	f ₀								
85	130	22	1.1	0.6	60.1	58.7	—	—	15.9	7 600	10 000	7017C	25.5	92	123	1	0.970
	150	28	2	1	98.6	83.6	103	89.2	—	5 000	6 300	7217	47.9	95	140	2	1.87
	150	28	2	1	89.2	76.0	93.1	81.1	—	3 800	5 000	7217B	63.3	95	140	2	1.87
	150	28	2	1	107	90.6	112	96.6	14.7	7 000	9 200	7217C	29.7	95	140	2	1.87
	180	41	3	1.1	150	122	159	133	—	4 400	5 500	7317	58.8	99	166	2.5	4.53
	180	41	3	1.1	137	112	145	122	—	3 300	4 400	7317B	76.1	99	166	2.5	4.53
	180	41	3	1.1	161	130	170	142	13.5	6 100	8 100	7317C	38.3	99	166	2.5	4.53
	210	52	4	1.5	204	180	—	—	—	3 000	3 900	7417	68.7	103	192	3	8.54
	210	52	4	1.5	189	167	—	—	—	2 600	3 600	7417B	88.1	103	192	3	8.54
	90	125	18	1.1	0.6	39.6	42.6	—	—	16.6	7 800	10 000	7918C	23.4	97	118	1
125		18	1.1	0.6	16.8	15.1	—	—	8.8	9 700	15 000	HAR918C	23.4	97	118	1	0.598
140		24	1.5	1	32.8	26.1	—	—	8.4	9 100	14 000	HAR018C	27.4	98.5	131.5	1.5	1.21
140		24	1.5	1	65.2	63.3	—	—	—	5 100	6 400	7018	45.2	98.5	131.5	1.5	1.26
140		24	1.5	1	58.4	57.1	—	—	—	3 900	5 100	7018B	60.2	98.5	131.5	1.5	1.26
140		24	1.5	1	71.7	69.1	—	—	15.7	7 100	9 400	7018C	27.4	98.5	131.5	1.5	1.26
160		30	2	1	113	96.7	118	103	—	4 700	5 900	7218	51.1	100	150	2	2.30
160		30	2	1	102	88.0	107	93.8	—	3 500	4 700	7218B	67.4	100	150	2	2.30
160		30	2	1	123	105	128	112	14.6	6 500	8 600	7218C	31.7	100	150	2	2.30
190		43	3	1.1	161	135	171	147	—	4 200	5 200	7318	61.9	104	176	2.5	5.30
190		43	3	1.1	148	124	156	135	—	3 100	4 200	7318B	80.2	104	176	2.5	5.30
190		43	3	1.1	173	145	183	158	13.5	5 800	7 700	7318C	40.3	104	176	2.5	5.30
225		54	4	1.5	216	196	—	—	—	2 800	3 700	7418	72.5	108	207	3	11.4
225		54	4	1.5	200	182	—	—	—	2 500	3 400	7418B	93.1	108	207	3	11.4
95	130	18	1.1	0.6	40.2	44.1	—	—	16.5	7 400	9 800	7919C	24.1	102	123	1	0.574
	130	18	1.1	0.6	17.3	16.0	—	—	8.8	9 300	14 000	HAR919C	24.1	102	123	1	0.626
	145	24	1.5	1	33.4	27.2	—	—	8.5	8 700	13 000	HAR019C	28.1	103.5	136.5	1.5	1.28
	145	24	1.5	1	66.6	67.1	—	—	—	4 800	6 000	7019	47.2	103.5	136.5	1.5	1.32

[Notes] 1) Limiting speeds shown above are applicable to machined cage bearings. Limiting speeds of pressed cage bearings should be kept to under 80% of this value. For bearings with 15° contact angle, this figure is applied to the high precision bearings ranked higher than class 5, used with machined cage or molded cage.

2) B, C or no indication after the bearing number indicates nominal contact angle of 40°, 15° and 30° respectively.

[Remark] Standard cage types used for the above bearings are described earlier in this section.

Single-row angular contact ball bearings

d (95) ~ (105) mm

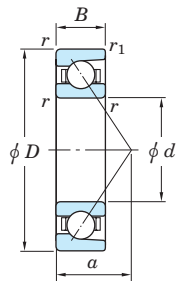

With machined cage

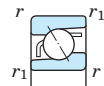

With pressed cage



HAR

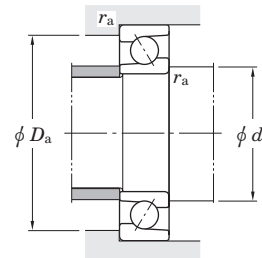

Boundary dimensions (mm)					Basic load ratings (kN)				Factor	Limiting speeds ¹⁾ (min ⁻¹)		Bearing No. ²⁾	Load center (mm) α	Mounting dimensions (mm)			(Refer.) Mass (kg)
d	D	B	r min.	r1 min.	With machined cage		With pressed cage			Grease lub.	Oil lub.			da min.	Da max.	ra max.	
95	145	24	1.5	1	59.6	60.5	—	—	—	3 600	4 800	7019B	63.2	103.5	136.5	1.5	1.32
	145	24	1.5	1	73.4	73.4	—	—	15.9	6 700	8 900	7019C	28.3	103.5	136.5	1.5	1.32
	170	32	2.1	1.1	122	103	128	111	—	4 400	5 500	7219	54.3	107	158	2	2.78
	170	32	2.1	1.1	111	94.0	116	101	—	3 300	4 400	7219B	71.6	107	158	2	2.78
	170	32	2.1	1.1	133	112	139	120	14.6	6 100	8 100	7219C	33.8	107	158	2	2.78
	200	45	3	1.1	172	149	183	162	—	4 000	4 900	7319	65.1	109	186	2.5	6.12
	200	45	3	1.1	158	137	167	149	—	3 000	4 000	7319B	84.4	109	186	2.5	6.12
	200	45	3	1.1	185	160	196	174	13.5	5 500	7 300	7319C	42.3	109	186	2.5	6.12
100	140	20	1.1	0.6	55.6	58.5	—	—	16.3	7 000	9 200	7920C	26.1	107	133	1	0.773
	140	20	1.1	0.6	24.2	21.7	—	—	8.7	8 700	13 000	HAR920C	26.1	107	133	1	0.839
	150	24	1.5	1	34.0	28.4	—	—	8.5	8 400	13 000	HAR020C	28.7	108.5	141.5	1.5	1.32
	150	24	1.5	1	68.4	70.6	—	—	—	4 700	5 900	7020	48.1	108.5	141.5	1.5	1.37
	150	24	1.5	1	61.2	63.6	—	—	—	3 500	4 700	7020B	64.4	108.5	141.5	1.5	1.37
	150	24	1.5	1	75.3	77.2	—	—	16.0	6 500	8 600	7020C	28.7	108.5	141.5	1.5	1.37
	180	34	2.1	1.1	137	117	144	126	—	4 100	5 200	7220	57.7	112	168	2	3.32
	180	34	2.1	1.1	124	107	130	115	—	3 100	4 200	7220B	76.2	112	168	2	3.32
	180	34	2.1	1.1	149	127	156	136	14.6	5 700	7 600	7220C	35.9	112	168	2	3.32
	215	47	3	1.1	184	161	207	194	—	3 600	4 600	7320	69.4	114	201	2.5	7.53
	215	47	3	1.1	168	148	190	178	—	2 700	3 600	7320B	90.2	114	201	2.5	7.53
	215	47	3	1.1	197	173	222	208	13.4	5 000	6 700	7320C	44.8	114	201	2.5	7.53
105	145	20	1.1	0.6	56.7	61.5	—	—	16.4	6 700	8 800	7921C	26.7	112	138	1	0.810
	145	20	1.1	0.6	24.9	23.1	—	—	8.7	8 400	13 000	HAR921C	26.7	112	138	1	0.874
	160	26	2	1	38.6	32.5	—	—	8.5	7 900	12 000	HAR021C	30.8	115	150	2	1.68
	160	26	2	1	79.8	81.9	—	—	—	4 400	5 500	7021	51.8	115	150	2	1.73
	160	26	2	1	71.4	73.8	—	—	—	3 300	4 400	7021B	68.6	115	150	2	1.73
	160	26	2	1	87.8	89.6	—	—	15.9	6 000	8 000	7021C	31.0	115	150	2	1.73
	190	36	2.1	1.1	149	132	—	—	—	3 900	4 900	7221	61.0	117	178	2	3.95

[Notes] 1) Limiting speeds shown above are applicable to machined cage bearings. Limiting speeds of pressed cage bearings should be kept to under 80% of this value. For bearings with 15° contact angle, this figure is applied to the high precision bearings ranked higher than class 5, used with machined cage or molded cage.

2) B, C or no indication after the bearing number indicates nominal contact angle of 40°, 15° and 30° respectively.

[Remark] Standard cage types used for the above bearings are described earlier in this section.

Single-row angular contact ball bearings

d (105) ~ (120) mm

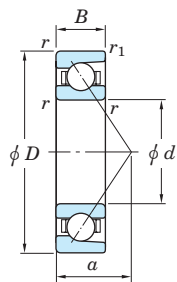

With machined cage

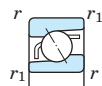

With pressed cage

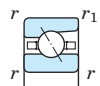

HAR

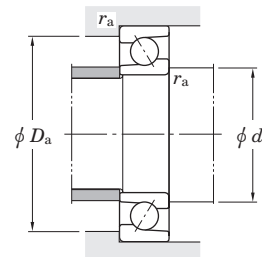

Boundary dimensions (mm)					Basic load ratings (kN)				Factor	Limiting speeds ¹⁾ (min ⁻¹)		Bearing No. ²⁾	Load center (mm) α	Mounting dimensions (mm)			(Refer.) Mass (kg)
d	D	B	$r_{min.}$	$r_{1min.}$	With machined cage		With pressed cage			Grease lub.	Oil lub.			d_a min.	D_a max.	r_a max.	
105	190	36	2.1	1.1	135	121	—	—	—	2 900	3 900	7221B	80.5	117	178	2	3.95
	190	36	2.1	1.1	162	143	—	—	14.6	5 400	7 200	7221C	38.0	117	178	2	3.95
	225	49	3	1.1	208	193	—	—	—	3 500	4 400	7321	72.1	119	211	2.5	8.62
	225	49	3	1.1	191	177	—	—	—	2 600	3 500	7321B	93.7	119	211	2.5	8.62
	225	49	3	1.1	223	207	—	—	13.4	4 800	6 400	7321C	46.6	119	211	2.5	8.62
110	150	20	1.1	0.6	57.7	64.4	—	—	16.5	6 400	8 500	7922C	27.4	117	143	1	0.840
	150	20	1.1	0.6	25.1	23.8	—	—	8.7	8 000	12 000	HAR922C	27.4	117	143	1	0.909
	170	28	2	1	43.4	37.0	—	—	8.5	7 500	12 000	HAR022C	32.8	120	160	2	2.11
	170	28	2	1	91.9	92.8	—	—	—	4 200	5 200	7022	54.4	120	160	2	2.14
	170	28	2	1	82.3	83.7	—	—	—	3 100	4 200	7022B	72.7	120	160	2	2.14
	170	28	2	1	101	101	—	—	15.7	5 800	7 700	7022C	32.8	120	160	2	2.14
	200	38	2.1	1.1	162	148	—	—	—	3 700	4 600	7222	64.3	122	188	2	4.65
	200	38	2.1	1.1	147	135	—	—	—	2 800	3 700	7222B	84.9	122	188	2	4.65
	200	38	2.1	1.1	176	160	—	—	14.5	5 100	6 800	7222C	40.0	122	188	2	4.65
	240	50	3	1.1	232	226	—	—	—	3 200	4 000	7322	76.4	124	226	2.5	10.1
	240	50	3	1.1	213	208	—	—	—	2 400	3 200	7322B	99.6	124	226	2.5	10.1
	240	50	3	1.1	249	242	—	—	13.4	4 500	5 900	7322C	48.8	124	226	2.5	10.1
120	165	22	1.1	0.6	71.7	81.2	—	—	16.5	5 900	7 800	7924C	30.1	127	158	1	1.15
	165	22	1.1	0.6	29.4	28.4	—	—	8.8	7 300	11 000	HAR924C	30.1	127	158	1	1.25
	180	28	2	1	44.9	39.9	—	—	8.5	7 000	11 000	HAR024C	34.1	130	170	2	2.26
	180	28	2	1	96.6	103	—	—	—	3 900	4 900	7024	57.3	130	170	2	2.27
	180	28	2	1	86.4	93.0	—	—	—	2 900	3 900	7024B	76.9	130	170	2	2.27
	180	28	2	1	106	113	—	—	16.0	5 400	7 100	7024C	34.1	130	170	2	2.27
	215	40	2.1	1.1	174	166	—	—	—	3 400	4 300	7224	68.5	132	203	2	5.49
	215	40	2.1	1.1	158	151	—	—	—	2 600	3 400	7224B	90.3	132	203	2	5.49
	215	40	2.1	1.1	190	180	—	—	14.6	4 800	6 300	7224C	42.5	132	203	2	5.49
	260	55	3	1.1	246	252	—	—	—	3 000	3 700	7324	82.3	134	246	2.5	12.6

[Notes] 1) Limiting speeds shown above are applicable to machined cage bearings. Limiting speeds of pressed cage bearings should be kept to under 80% of this value. For bearings with 15° contact angle, this figure is applied to the high precision bearings ranked higher than class 5, used with machined cage or molded cage.

2) B, C or no indication after the bearing number indicates nominal contact angle of 40°, 15° and 30° respectively.

[Remark] Standard cage types used for the above bearings are described earlier in this section.

Single-row angular contact ball bearings

d (120) ~ 140 mm

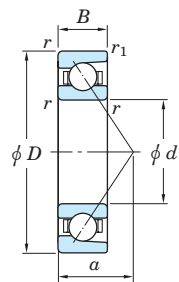

With machined cage

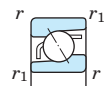

With pressed cage



HAR

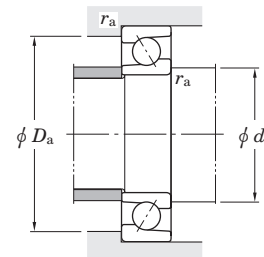

Boundary dimensions (mm)					Basic load ratings (kN)				Factor	Limiting speeds ¹⁾ (min ⁻¹)		Bearing No. ²⁾	Load center (mm) a	Mounting dimensions (mm)			(Refer.) Mass (kg)
d	D	B	$r_{min.}$	$r_{1min.}$	With machined cage		With pressed cage			Grease lub.	Oil lub.			d_a min.	D_a max.	r_a max.	
120	260	55	3	1.1	225	231	—	—	—	2 200	3 000	7324B	107.2	134	246	2.5	12.6
	260	55	3	1.1	265	271	—	—	13.7	4 100	5 500	7324C	53.0	134	246	2.5	12.6
130	180	24	1.5	1	87.2	99.9	—	—	16.4	5 400	7 100	7926C	32.8	138.5	171.5	1.5	1.50
	180	24	1.5	1	35.1	35.1	—	—	8.8	6 700	10 000	HAR926C	32.8	138.5	171.5	1.5	1.66
	200	33	2	1	56.3	48.4	—	—	8.5	6 300	9 800	HAR026C	38.6	140	190	2	3.38
	200	33	2	1	117	125	—	—	—	3 500	4 400	7026	64.1	140	190	2	3.43
	200	33	2	1	105	113	—	—	—	2 600	3 500	7026B	85.7	140	190	2	3.43
	200	33	2	1	129	137	—	—	15.9	4 800	6 400	7026C	38.6	140	190	2	3.43
	230	40	3	1.1	196	198	—	—	—	3 200	4 000	7226	72.0	144	216	2.5	6.21
	230	40	3	1.1	177	180	—	—	—	2 400	3 200	7226B	95.5	144	216	2.5	6.21
	230	40	3	1.1	213	214	—	—	14.7	4 400	5 800	7226C	44.1	144	216	2.5	6.21
	280	58	4	1.5	301	329	—	—	—	2 700	3 400	7326	88.8	148	262	3	15.4
	280	58	4	1.5	250	268	—	—	—	2 100	2 700	7326B	115.0	148	262	3	15.4
	280	58	4	1.5	294	314	—	—	13.7	3 800	5 000	7326C	56.5	148	262	3	15.4
140	190	24	1.5	1	88.3	105	—	—	16.6	5 100	6 700	7928C	34.1	148.5	181.5	1.5	1.59
	190	24	1.5	1	35.2	36.2	—	—	8.8	6 300	9 800	HAR928C	34.1	148.5	181.5	1.5	1.76
	210	33	2	1	61.3	56.2	—	—	8.5	6 000	9 200	HAR028C	39.9	150	200	2	3.62
	210	33	2	1	120	133	—	—	—	3 300	4 100	7028	67.0	150	200	2	3.64
	210	33	2	1	107	119	—	—	—	2 500	3 300	7028B	89.9	150	200	2	3.64
	210	33	2	1	132	145	—	—	16.0	4 500	6 000	7028C	39.9	150	200	2	3.64
	250	42	3	1.1	218	234	—	—	—	2 900	3 600	7228	77.3	154	236	2.5	7.76
	250	42	3	1.1	197	213	—	—	—	2 200	2 900	7228B	102.8	154	236	2.5	7.76
	250	42	3	1.1	238	254	—	—	14.8	4 000	5 300	7228C	47.1	154	236	2.5	7.76
	300	62	4	1.5	329	374	—	—	—	2 500	3 200	7328	94.5	158	282	3	18.8
	300	62	4	1.5	302	344	—	—	—	1 900	2 500	7328B	123.3	158	282	3	18.8
	300	62	4	1.5	353	401	—	—	13.4	3 500	4 600	7328C	60.5	158	282	3	18.8

[Notes] 1) Limiting speeds shown above are applicable to machined cage bearings.
Limiting speeds of pressed cage bearings should be kept to under 80% of this value.
For bearings with 15° contact angle, this figure is applied to the high precision bearings ranked higher than class 5, used with machined cage or molded cage.

2) B, C or no indication after the bearing number indicates nominal contact angle of 40°, 15° and 30° respectively.
[Remark] Standard cage types used for the above bearings are described earlier in this section.

Single-row angular contact ball bearings

d 150 ~ (170) mm

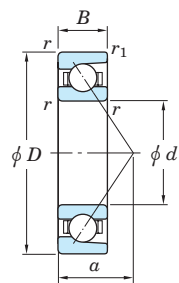

With machined cage

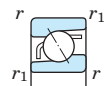

With pressed cage



HAR

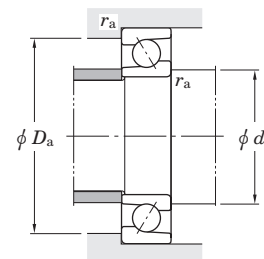

Boundary dimensions (mm)					Basic load ratings (kN)				Factor	Limiting speeds ¹⁾ (min ⁻¹)		Bearing No. ²⁾	Load center (mm) α	Mounting dimensions (mm)			(Refer.) Mass (kg)
d	D	B	r _{min.}	r _{1 min.}	With machined cage		With pressed cage			Grease lub.	Oil lub.			d _{a min.}	D _{a max.}	r _{a max.}	
150	210	28	2	1	115	132	—	—	16.3	4 700	6 200	7930C	38.1	160	200	2	2.47
	210	28	2	1	48.9	48.9	—	—	8.7	5 800	9 000	HAR930C	38.1	160	200	2	2.68
	225	35	2	1	72.2	66.1	—	—	8.5	5 300	8 200	HAR030C	42.6	160	215	2	4.36
	225	35	2.1	1.1	137	154	—	—	—	3 000	3 800	7030	72.1	162	213	2	4.43
	225	35	2.1	1.1	122	138	—	—	—	2 300	3 000	7030B	96.2	162	213	2	4.43
	225	35	2.1	1.1	151	169	—	—	16.1	4 200	5 500	7030C	42.8	162	213	2	4.43
	270	45	3	1.1	248	280	—	—	—	2 700	3 300	7230	83.1	164	256	2.5	9.75
	270	45	3	1.1	225	254	—	—	—	2 000	2 700	7230B	110.6	164	256	2.5	9.75
	270	45	3	1.1	270	303	—	—	14.7	3 700	4 900	7230C	50.6	164	256	2.5	9.75
	320	65	4	1.5	348	414	—	—	—	2 300	2 900	7330	100.3	168	302	3	22.4
320	65	4	1.5	318	380	—	—	—	1 800	2 300	7330B	131.1	168	302	3	22.4	
320	65	4	1.5	374	445	—	—	13.7	3 200	4 300	7330C	64.0	168	302	3	22.4	
160	220	28	2	1	120	144	—	—	16.5	4 400	5 800	7932C	39.5	170	210	2	2.60
	220	28	2	1	50.2	51.8	—	—	8.8	5 200	8 100	HAR932C	39.5	170	210	2	2.83
	240	38	2.1	1.1	78.3	72.7	—	—	8.5	5 000	7 700	HAR032C	45.8	172	228	2	5.40
	240	38	2.1	1.1	155	176	—	—	—	2 800	3 500	7032	76.8	172	228	2	5.45
	240	38	2.1	1.1	139	158	—	—	—	2 100	2 800	7032B	102.9	172	228	2	5.45
	240	38	2.1	1.1	171	193	—	—	16.0	3 900	5 200	7032C	45.8	172	228	2	5.45
	290	48	3	1.1	230	263	—	—	—	2 500	3 100	7232	89.0	174	276	2.5	12.1
	290	48	3	1.1	238	279	—	—	—	1 800	2 500	7232B	118.4	174	276	2.5	12.1
	290	48	3	1.1	287	333	—	—	15.2	3 400	4 500	7232C	54.1	174	276	2.5	12.1
	340	68	4	1.5	365	455	—	—	—	2 200	2 700	7332	106.2	178	322	3	26.4
340	68	4	1.5	332	416	—	—	—	1 600	2 200	7332B	138.9	178	322	3	26.4	
340	68	4	1.5	394	490	—	—	14.0	3 000	4 000	7332C	67.5	168.5	322	3	26.4	
170	230	28	2	1	122	151	—	—	16.6	3 900	5 100	7934C	40.8	180	220	2	3.21
	230	28	2	1	51.4	54.8	—	—	8.8	5 000	7 700	HAR934C	40.8	180	220	2	2.97
	260	42	2.1	1.1	91.8	86.4	—	—	8.5	4 600	7 100	HAR034C	49.8	182	248	2	7.32

[Notes] 1) Limiting speeds shown above are applicable to machined cage bearings.
 Limiting speeds of pressed cage bearings should be kept to under 80% of this value.
 For bearings with 15° contact angle, this figure is applied to the high precision bearings ranked higher than class 5, used with machined cage or molded cage.

2) B, C or no indication after the bearing number indicates nominal contact angle of 40°, 15° and 30° respectively.
 [Remark] Standard cage types used for the above bearings are described earlier in this section.

Single-row angular contact ball bearings

d (170) ~ 190 mm

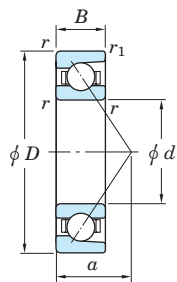

With machined cage

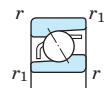

With pressed cage



HAR

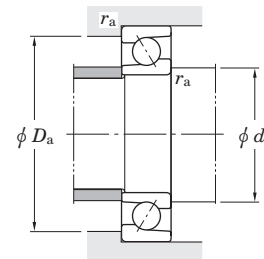

Boundary dimensions (mm)					Basic load ratings (kN)				Factor	Limiting speeds ¹⁾ (min ⁻¹)		Bearing No. ²⁾	Load center (mm) α	Mounting dimensions (mm)			(Refer.) Mass (kg)
d	D	B	r _{min.}	r _{1 min.}	With machined cage		With pressed cage			Grease lub.	Oil lub.			d _{a min.}	D _{a max.}	r _{a max.}	
170	260	42	2.1	1.1	186	214	—	—	—	2 600	3 200	7034	83.1	182	248	2	7.58
	260	42	2.1	1.1	166	193	—	—	—	1 900	2 600	7034B	111.2	182	248	2	7.77
	260	42	2.1	1.1	204	234	—	—	15.9	3 600	4 800	7034C	49.8	182	248	2	7.57
	310	52	4	1.5	272	331	—	—	—	2 300	2 800	7234	95.3	188	292	3	15.1
	310	52	4	1.5	245	300	—	—	—	1 700	2 300	7234B	126.7	188	292	3	15.1
	310	52	4	1.5	297	359	—	—	15.1	3 100	4 200	7234C	58.2	188	292	3	15.1
	360	72	4	1.5	389	485	—	—	—	2 000	2 500	7334	112.5	188	342	3	31.2
	360	72	4	1.5	355	444	—	—	—	1 500	2 000	7334B	147.2	188	342	3	31.2
	360	72	4	1.5	418	521	—	—	13.8	2 800	3 700	7334C	71.5	188	342	3	31.2
180	250	33	2	1	156	188	—	—	16.4	3 600	4 700	7936C	45.3	190	240	2	4.68
	280	46	2.1	1.1	212	253	—	—	—	2 400	3 000	7036	89.4	192	268	2	10.1
	280	46	2.1	1.1	190	228	—	—	—	1 800	2 400	7036B	119.5	192	268	2	10.2
	280	46	2.1	1.1	233	276	—	—	15.7	3 300	4 400	7036C	53.8	192	268	2	9.96
	320	52	4	1.5	293	362	—	—	—	2 200	2 700	7236	98.2	198	302	3	15.7
	320	52	4	1.5	265	329	—	—	—	1 600	2 200	7236B	130.9	198	302	3	15.7
	320	52	4	1.5	320	393	—	—	14.9	3 000	4 000	7236C	59.5	198	302	3	15.7
	380	75	4	1.5	409	534	—	—	—	1 900	2 400	7336	118.3	198	362	3	40.0
	380	75	4	1.5	373	488	—	—	—	1 400	1 900	7336B	155.0	198	362	3	40.0
	190	260	33	2	1	158	197	—	—	16.5	3 300	4 500	7938C	46.6	200	250	2
290		46	2.1	1.1	217	268	—	—	—	2 300	2 800	7038	92.3	202	278	2	10.8
290		46	2.1	1.1	194	241	—	—	—	1 700	2 300	7038B	123.7	202	278	2	10.8
290		46	2.1	1.1	239	293	—	—	15.9	3 100	4 200	7038C	55.2	202	278	2	10.8
340		55	4	1.5	303	390	—	—	—	2 000	2 500	7238	104.0	208	322	3	18.8
340		55	4	1.5	273	353	—	—	—	1 500	2 000	7238B	138.7	208	322	3	18.8
340		55	4	1.5	331	424	—	—	15.1	2 800	3 700	7238C	63.0	208	322	3	18.8
400		78	5	2	450	598	—	—	—	1 800	2 200	7338	124.2	212	378	4	45.5
400		78	5	2	411	548	—	—	—	1 300	1 800	7338B	162.8	212	378	4	45.5

[Notes] 1) Limiting speeds shown above are applicable to machined cage bearings.
 Limiting speeds of pressed cage bearings should be kept to under 80% of this value.
 For bearings with 15° contact angle, this figure is applied to the high precision bearings ranked higher than class 5, used with machined cage or molded cage.

2) B, C or no indication after the bearing number indicates nominal contact angle of 40°, 15° and 30° respectively.
 [Remark] Standard cage types used for the above bearings are described earlier in this section.

Single-row angular contact ball bearings

d 200 ~ (340) mm

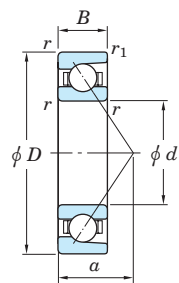

With machined cage

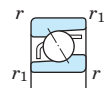

With pressed cage



HAR

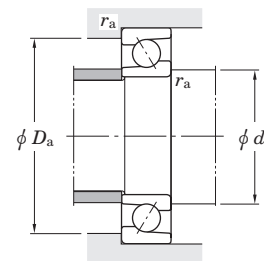

Boundary dimensions (mm)					Basic load ratings (kN)				Factor	Limiting speeds ¹⁾ (min ⁻¹)		Bearing No. ²⁾	Load center (mm) α	Mounting dimensions (mm)			(Refer.) Mass (kg)
d	D	B	r _{min.}	r _{1 min.}	With machined cage		With pressed cage			Grease lub.	Oil lub.			d _{a min.}	D _{a max.}	r _{a max.}	
200	280	38	2.1	1.1	204	255	—	—	16.3	3 100	4 100	7940C	51.2	212	268	2	6.85
	310	51	2.1	1.1	244	309	—	—	—	2 100	2 600	7040	99.1	212	298	2	12.7
	310	51	2.1	1.1	218	279	—	—	—	1 600	2 100	7040B	132.5	212	298	2	12.7
	310	51	2.1	1.1	268	338	—	—	15.7	2 900	3 900	7040C	59.7	212	298	2	12.7
	360	58	4	1.5	324	423	—	—	—	1 900	2 400	7240	109.8	218	342	3	22.4
	360	58	4	1.5	292	384	—	—	—	1 400	1 900	7240B	146.5	218	342	3	22.4
	360	58	4	1.5	354	460	—	—	15.1	2 600	3 500	7240C	66.5	218	342	3	22.4
	420	80	5	2	474	658	—	—	—	1 700	2 100	7340	129.5	222	398	4	52.0
	420	80	5	2	432	602	—	—	—	1 200	1 700	7340B	170.1	222	398	4	52.0
220	340	56	3	1.1	267	353	—	—	—	1 900	2 400	7044	108.9	234	326	2.5	18.5
	340	56	3	1.1	239	318	—	—	—	1 400	1 900	7044B	145.5	234	326	2.5	18.9
240	360	56	3	1.1	273	375	—	—	—	1 700	2 200	7048	114.6	254	346	2.5	19.7
	360	56	3	1.1	244	338	—	—	—	1 300	1 700	7048B	153.9	254	346	2.5	20.1
	440	72	4	1.5	403	595	—	—	—	1 500	1 800	7248	134.2	258	422	3	51.8
	440	72	4	1.5	363	539	—	—	—	1 100	1 500	7248B	178.6	258	422	3	52.8
260	400	65	4	1.5	325	478	—	—	—	1 500	1 900	7052	128.4	278	382	3	28.7
	400	65	4	1.5	291	431	—	—	—	1 100	1 500	7052B	171.0	278	382	3	29.3
280	420	65	4	1.5	332	507	—	—	—	1 400	1 800	7056	133.5	298	402	3	30.4
	420	65	4	1.5	297	453	—	—	—	1 100	1 400	7056B	179.3	298	402	3	31.0
300	460	74	4	1.5	426	680	—	—	—	1 300	1 600	7060	146.7	318	442	3	43.7
	460	74	4	1.5	382	613	—	—	—	960	1 300	7060B	196.4	318	442	3	44.9
320	480	74	4	1.5	437	722	—	—	—	1 200	1 500	7064	152.5	338	462	3	46.0
	480	74	4	1.5	391	651	—	—	—	890	1 200	7064B	204.8	338	462	3	47.2
340	520	82	5	2	502	861	—	—	—	1 100	1 300	7068	165.1	362	498	4	61.8

[Notes] 1) Limiting speeds shown above are applicable to machined cage bearings. Limiting speeds of pressed cage bearings should be kept to under 80% of this value. For bearings with 15° contact angle, this figure is applied to the high precision bearings ranked higher than class 5, used with machined cage or molded cage.

2) B, C or no indication after the bearing number indicates nominal contact angle of 40°, 15° and 30° respectively. [Remark] Standard cage types used for the above bearings are described earlier in this section.

Single-row angular contact ball bearings

d (340) ~ 380 mm

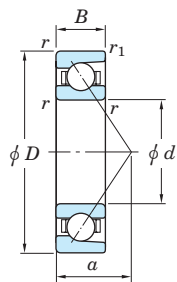

With machined cage

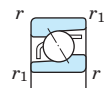

With pressed cage



HAR

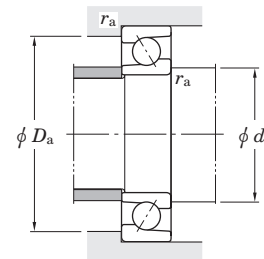

Boundary dimensions (mm)					Basic load ratings (kN)				Factor	Limiting speeds ¹⁾ (min ⁻¹)		Bearing No. ²⁾	Load center (mm) a	Mounting dimensions (mm)			(Refer.) Mass (kg)
d	D	B	$r_{min.}$	$r_{1min.}$	With machined cage		With pressed cage			Grease lub.	Oil lub.			d_a min.	D_a max.	r_a max.	
340	520	82	5	2	450	777	—	—	—	800	1 100	7068B	221.4	362	498	4	63.3
	540	82	5	2	461	824	—	—	—	1 000	1 300						
360	540	82	5	2	461	824	—	—	—	750	1 000	7072B	229.8	382	518	4	66.2
	560	82	5	2	528	966	—	—	—	940	1 200						
380	560	82	5	2	472	870	—	—	—	700	940	7076B	238.2	402	538	4	69.1

[Notes] 1) Limiting speeds shown above are applicable to machined cage bearings. Limiting speeds of pressed cage bearings should be kept to under 80% of this value. For bearings with 15° contact angle, this figure is applied to the high precision bearings ranked higher than class 5, used with machined cage or molded cage.

2) B or no indication after the bearing number indicates nominal contact angle of 15° and 30° respectively. [Remark] Standard cage types used for the above bearings are described earlier in this section.

Angular contact ball bearings (matched pair)

d 10 ~ (17) mm

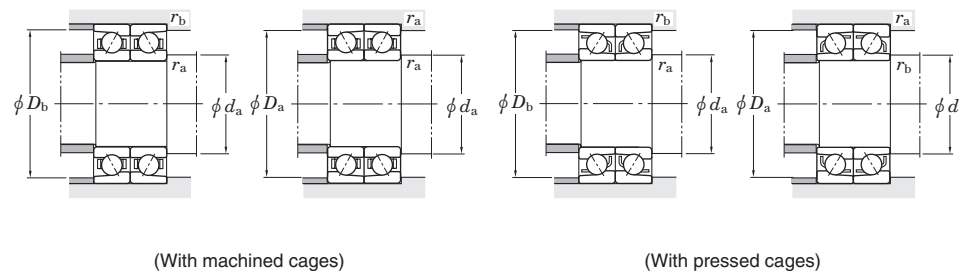
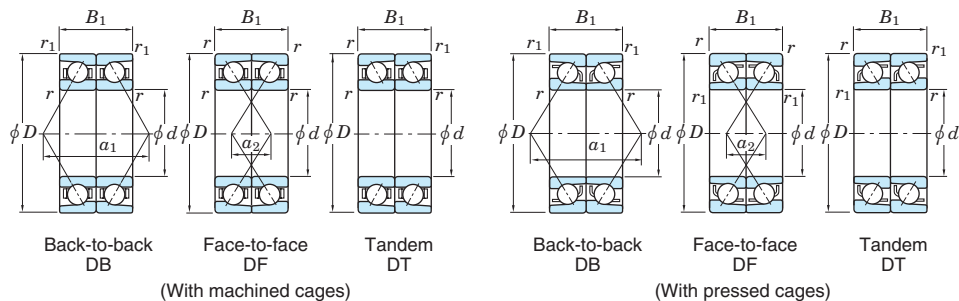

Boundary dimensions (mm)					Basic load ratings (kN)				Factor	Limiting speeds ¹⁾ (min ⁻¹)		Bearing No. ²⁾			Load center spread (mm)		Mounting dimensions (mm)						(Refer.) Mass (kg)
d	D	B ₁	r min.	r ₁ min.	With machined cages		With pressed cages			Grease lub.	Oil lub.	Back-to-back DB	Face-to-face DF	Tandem DT	a ₁	a ₂	d _a min.	d _b min.	D _a max.	D _b max.	r _a max.	r _b max.	
10	22	12	0.3	0.15	4.90	3.05	—	—	14.2	42 000	55 000	7900CDB	7900CDF	7900CDT	10.3	1.7	12.5	—	19.5	20.8	0.3	0.15	0.016
	26	16	0.3	0.15	8.10	4.65	—	—	—	27 000	34 000	7000DB	7000DF	7000DT	18.2	2.2	12.5	—	23.5	24.8	0.3	0.15	0.042
	26	16	0.3	0.15	7.55	4.35	—	—	—	20 000	27 000	7000BDB	7000BDF	7000BDT	23.1	7.1	12.5	—	23.5	24.8	0.3	0.15	0.042
	26	16	0.3	0.15	8.60	4.95	—	—	12.5	37 000	50 000	7000CDB	7000CDF	7000CDT	12.7	3.3	12.5	—	23.5	24.8	0.3	0.15	0.042
	30	18	0.6	0.3	7.55	4.40	8.80	5.45	—	23 000	29 000	7200DB	7200DF	7200DT	20.8	2.8	14.5	12.5	25.5	27.5	0.6	0.3	0.062
	30	18	0.6	0.3	6.95	4.05	8.10	5.05	—	18 000	23 000	7200BDB	7200BDF	7200BDT	26.2	8.2	14.5	12.5	25.5	27.5	0.6	0.3	0.062
	30	18	0.6	0.3	8.10	4.70	9.45	5.85	13.4	32 000	43 000	7200CDB	7200CDF	7200CDT	14.5	3.5	14.5	12.5	25.5	27.5	0.6	0.3	0.062
	35	22	0.6	0.3	13.8	7.55	15.1	8.60	—	21 000	27 000	7300DB	7300DF	7300DT	24.0	2.0	14.5	12.5	30.5	32.5	0.6	0.3	0.108
12	24	12	0.3	0.15	5.15	3.45	—	—	14.7	37 000	49 000	7901CDB	7901CDF	7901CDT	10.8	1.2	14.5	—	21.5	22.8	0.3	0.15	0.020
	28	16	0.3	0.15	8.80	5.45	—	—	—	23 000	29 000	7001DB	7001DF	7001DT	19.9	3.9	14.5	—	25.5	26.8	0.3	0.15	0.048
	28	16	0.3	0.15	8.10	5.05	—	—	—	18 000	23 000	7001BDB	7001BDF	7001BDT	25.2	9.2	14.5	—	25.5	26.8	0.3	0.15	0.048
	28	16	0.3	0.15	9.40	5.85	—	—	13.4	32 000	43 000	7001CDB	7001CDF	7001CDT	13.5	2.5	14.5	—	25.5	26.8	0.3	0.15	0.048
	32	20	0.6	0.3	12.1	7.25	13.0	8.05	—	22 000	27 000	7201DB	7201DF	7201DT	22.7	2.7	16.5	14.5	27.5	29.5	0.6	0.3	0.076
	32	20	0.6	0.3	11.3	6.80	12.1	7.50	—	16 000	22 000	7201BDB	7201BDF	7201BDT	28.5	8.5	16.5	14.5	27.5	29.5	0.6	0.3	0.076
	32	20	0.6	0.3	12.8	7.70	13.8	8.55	12.5	30 000	40 000	7201CDB	7201CDF	7201CDT	15.9	4.1	16.5	14.5	27.5	29.5	0.6	0.3	0.076
	37	24	1	0.6	16.6	9.20	18.1	10.5	—	20 000	24 000	7301DB	7301DF	7301DT	26.2	2.2	17.5	16.5	31.5	32.5	1	0.6	0.130
15	28	14	0.3	0.15	7.75	5.30	—	—	14.5	31 000	41 000	7902CDB	7902CDF	7902CDT	12.8	1.2	17.5	—	25.5	26.8	0.3	0.15	0.030
	32	18	0.3	0.15	9.95	6.85	—	—	—	20 000	26 000	7002DB	7002DF	7002DT	22.6	4.6	17.5	—	29.5	30.8	0.3	0.15	0.070
	32	18	0.3	0.15	9.05	6.30	—	—	—	15 000	20 000	7002BDB	7002BDF	7002BDT	29.1	11.1	17.5	—	29.5	30.8	0.3	0.15	0.070
	32	18	0.3	0.15	10.7	7.40	—	—	14.1	28 000	37 000	7002CDB	7002CDF	7002CDT	15.3	2.7	17.5	—	29.5	30.8	0.3	0.15	0.070
	35	22	0.6	0.3	13.2	8.55	13.2	8.55	—	19 000	24 000	7202DB	7202DF	7202DT	25.7	3.7	19.5	17.5	30.5	32.5	0.6	0.3	0.096
	35	22	0.6	0.3	12.1	7.85	12.1	7.85	—	14 000	19 000	7202BDB	7202BDF	7202BDT	32.4	10.4	19.5	17.5	30.5	32.5	0.6	0.3	0.096
	35	22	0.6	0.3	14.1	9.15	14.1	9.15	13.3	26 000	35 000	7202CDB	7202CDF	7202CDT	17.8	4.2	19.5	17.5	30.5	32.5	0.6	0.3	0.096
	42	26	1	0.6	20.3	12.9	21.8	14.4	—	16 000	20 000	7302DB	7302DF	7302DT	30.0	4.0	20.5	19.5	36.5	37.5	1	0.6	0.176
17	30	14	0.3	0.15	8.10	5.90	—	—	14.9	28 000	38 000	7903CDB	7903CDF	7903CDT	13.4	0.6	19.5	—	27.5	28.8	0.3	0.15	0.032
	35	20	0.3	0.15	10.9	8.25	—	—	—	18 000	23 000	7003DB	7003DF	7003DT	25.3	5.3	19.5	—	32.5	33.8	0.3	0.15	0.090

[Notes] 1) Limiting speeds shown above are applicable to machined cage bearings. Limiting speeds of pressed cage bearings should be kept to under 80% of this value. For bearings with 15° contact angle, this figure is applied to the high precision bearings ranked higher than class 5, used with machined cages or molded cages.

2) B, C or no indication after the bearing number indicates nominal contact angle of 40°, 15° and 30° respectively.

[Remark] Standard cage types used for the above bearings are described earlier in this section.

Angular contact ball bearings (matched pair)

d (17) ~ (25) mm

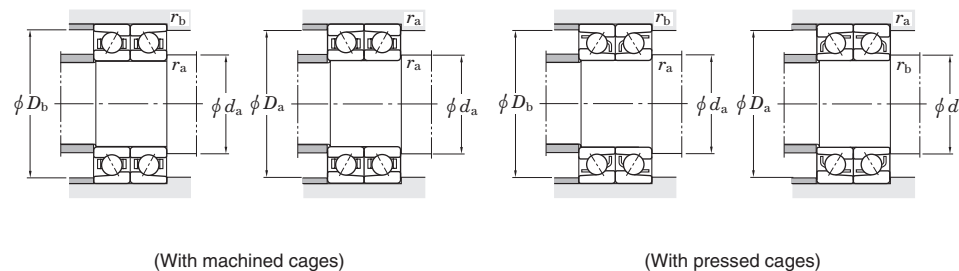

Boundary dimensions (mm)					Basic load ratings (kN)				Factor	Limiting speeds ¹⁾ (min ⁻¹)		Bearing No. ²⁾			Load center spread (mm)		Mounting dimensions (mm)						(Refer.) Mass (kg)
d	D	B ₁	r min.	r ₁ min.	With machined cages		With pressed cages			Grease lub.	Oil lub.	Back-to-back DB	Face-to-face DF	Tandem DT	a ₁	a ₂	d _a min.	d _b min.	D _a max.	D _b max.	r _a max.	r _b max.	
17	35	20	0.3	0.15	9.90	7.50	—	—	—	14 000	18 000	7003BDB	7003BDF	7003BDT	32.2	12.2	19.5	—	32.5	33.8	0.3	0.15	0.090
	35	20	0.3	0.15	11.9	8.95	—	—	14.6	25 000	33 000	7003CDB	7003CDF	7003CDT	17.1	2.9	19.5	—	32.5	33.8	0.3	0.15	0.090
	40	24	0.6	0.3	16.5	11.0	16.5	11.0	—	17 000	21 000	7203DB	7203DF	7203DT	28.8	4.8	21.5	19.5	35.5	37.5	0.6	0.3	0.140
	40	24	0.6	0.3	15.2	10.1	15.2	10.1	—	12 000	17 000	7203BDB	7203BDF	7203BDT	36.3	12.3	21.5	19.5	35.5	37.5	0.6	0.3	0.140
	40	24	0.6	0.3	17.7	11.8	17.7	11.8	13.4	23 000	30 000	7203CDB	7203CDF	7203CDT	19.8	4.2	21.5	19.5	35.5	37.5	0.6	0.3	0.140
	47	28	1	0.6	24.2	15.8	26.0	17.5	—	15 000	18 000	7303DB	7303DF	7303DT	33.1	5.1	22.5	21.5	41.5	42.5	1	0.6	0.240
	47	28	1	0.6	22.5	14.6	24.1	16.2	—	11 000	15 000	7303BDB	7303BDF	7303BDT	41.7	13.7	22.5	21.5	41.5	42.5	1	0.6	0.240
	47	28	1	0.6	25.7	16.8	25.7	16.8	12.6	20 000	27 000	7303CDB	7303CDF	7303CDT	22.8	5.2	22.5	21.5	41.5	42.5	1	0.6	0.240
20	37	18	0.3	0.15	11.8	9.15	—	—	14.9	24 000	31 000	7904CDB	7904CDF	7904CDT	16.6	1.4	22.5	—	34.5	35.8	0.3	0.15	0.070
	42	24	0.6	0.3	16.7	12.2	—	—	—	15 000	19 000	7004DB	7004DF	7004DT	30.2	6.2	24.5	—	37.5	39.5	0.6	0.3	0.158
	42	24	0.6	0.3	15.2	11.1	—	—	—	11 000	15 000	7004BDB	7004BDF	7004BDT	38.4	14.4	24.5	—	37.5	39.5	0.6	0.3	0.158
	42	24	0.6	0.3	18.0	13.2	—	—	14.1	21 000	28 000	7004CDB	7004CDF	7004CDT	20.4	3.6	24.5	—	37.5	39.5	0.6	0.3	0.158
	47	28	1	0.6	23.5	16.8	24.9	18.3	—	14 000	17 000	7204DB	7204DF	7204DT	33.9	5.9	25.5	24.5	41.5	42.5	1	0.6	0.224
	47	28	1	0.6	21.6	15.4	22.9	16.8	—	10 000	14 000	7204BDB	7204BDF	7204BDT	42.9	14.9	25.5	24.5	41.5	42.5	1	0.6	0.224
	47	28	1	0.6	25.2	18.0	26.7	19.6	13.4	19 000	26 000	7204CDB	7204CDF	7204CDT	23.2	4.8	25.5	24.5	41.5	42.5	1	0.6	0.224
	52	30	1.1	0.6	28.3	18.8	30.4	20.8	—	13 000	17 000	7304DB	7304DF	7304DT	35.8	5.8	27	24.5	45	47.5	1	0.6	0.300
	52	30	1.1	0.6	26.3	17.4	28.2	19.3	—	10 000	13 000	7304BDB	7304BDF	7304BDT	45.2	15.2	27	24.5	45	47.5	1	0.6	0.300
	52	30	1.1	0.6	30.1	19.9	32.3	22.2	12.6	18 000	24 000	7304CDB	7304CDF	7304CDT	24.6	5.4	27	24.5	45	47.5	1	0.6	0.300
	72	38	1.1	0.6	57.8	38.2	—	—	—	7 400	11 000	7404DB	7404DF	7404DT	46.1	8.1	27	—	65	67.5	1	0.6	0.790
	72	38	1.1	0.6	54.4	35.9	—	—	—	6 400	9 600	7404BDB	7404BDF	7404BDT	58.4	20.4	27	—	65	67.5	1	0.6	0.790
25	42	18	0.3	0.15	12.7	10.9	—	—	15.5	20 000	27 000	7905CDB	7905CDF	7905CDT	18.2	0.2	27.5	—	39.5	40.8	0.3	0.15	0.082
	47	24	0.6	0.3	18.3	14.8	—	—	—	13 000	17 000	7005DB	7005DF	7005DT	32.9	8.9	29.5	—	42.5	44.5	0.6	0.3	0.182
	47	24	0.6	0.3	16.6	13.4	—	—	—	10 000	13 000	7005BDB	7005BDF	7005BDT	42.3	18.3	29.5	—	42.5	44.5	0.6	0.3	0.182
	47	24	0.6	0.3	20.0	16.0	—	—	14.7	18 000	24 000	7005CDB	7005CDF	7005CDT	21.7	2.3	29.5	—	42.5	44.5	0.6	0.3	0.182
	52	30	1	0.6	24.9	19.0	26.3	20.6	—	12 000	15 000	7205DB	7205DF	7205DT	37.5	7.5	30.5	29.5	46.5	47.5	1	0.6	0.270
	52	30	1	0.6	22.7	17.4	24.0	18.8	—	9 200	12 000	7205BDB	7205BDF	7205BDT	47.7	17.7	30.5	29.5	46.5	47.5	1	0.6	0.270
	52	30	1	0.6	26.9	20.5	28.4	22.2	14.0	17 000	23 000	7205CDB	7205CDF	7205CDT	25.5	4.5	30.5	29.5	46.5	47.5	1	0.6	0.270

[Notes] 1) Limiting speeds shown above are applicable to machined cage bearings. Limiting speeds of pressed cage bearings should be kept to under 80% of this value. For bearings with 15° contact angle, this figure is applied to the high precision bearings ranked higher than class 5, used with machined cages or molded cages.

2) B, C or no indication after the bearing number indicates nominal contact angle of 40°, 15° and 30° respectively. [Remark] Standard cage types used for the above bearings are described earlier in this section.

Angular contact ball bearings (matched pair)

d (25) ~ (35) mm

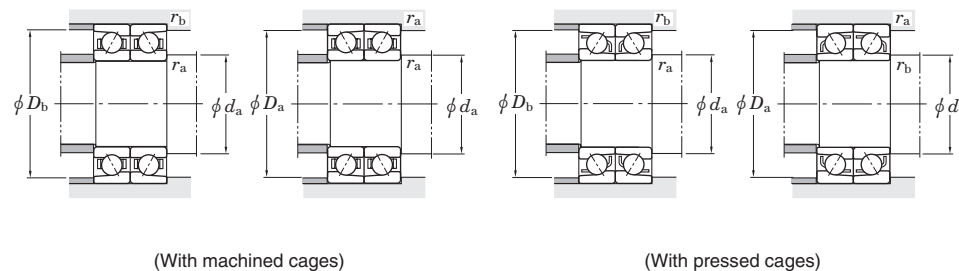
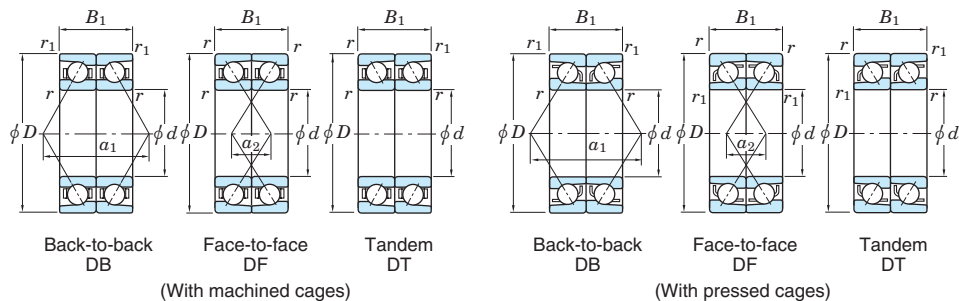

Boundary dimensions (mm)					Basic load ratings (kN)				Factor f_0	Limiting speeds ¹⁾ (min ⁻¹)		Bearing No. ²⁾			Load center spread (mm)		Mounting dimensions (mm)						(Refer.) Mass (kg)
d	D	B_1	$r_{min.}$	$r_{1min.}$	With machined cages		With pressed cages			Grease lub.	Oil lub.	Back-to-back DB	Face-to-face DF	Tandem DT	a_1	a_2	d_a min.	d_b min.	D_a max.	D_b max.	r_a max.	r_b max.	
25	62	34	1.1	0.6	40.3	28.8	42.9	31.6	—	11 000	14 000	7305DB	7305DF	7305DT	42.1	8.1	32	29.5	55	57.5	1	0.6	0.486
	62	34	1.1	0.6	37.2	26.6	39.6	29.2	—	8 300	11 000	7305BDB	7305BDF	7305BDT	53.5	19.5	32	29.5	55	57.5	1	0.6	0.486
	62	34	1.1	0.6	42.8	30.6	45.6	33.7	12.8	15 000	20 000	7305CDB	7305CDF	7305CDT	28.7	5.3	32	29.5	55	57.5	1	0.6	0.486
	80	42	1.5	1	64.5	46.3	69.2	51.5	—	6 400	9 100	7405DB	7405DF	7405DT	52.8	10.8	33.5	30.5	71.5	74.5	1.5	1	1.05
	80	42	1.5	1	60.0	43.0	64.3	47.8	—	5 500	8 200	7405BDB	7405BDF	7405BDT	67.2	25.2	33.5	30.5	71.5	74.5	1.5	1	1.05
30	47	18	0.3	0.15	13.5	12.5	—	—	15.9	18 000	23 000	7906CDB	7906CDF	7906CDT	19.3	1.3	32.5	—	44.5	45.8	0.3	0.15	0.092
	55	26	1	0.6	14.2	9.75	—	—	7.9	21 000	32 000	HAR006CDB	HAR006CDF	HAR006CDT	24.4	1.6	35.5	—	49.5	50.5	1	0.6	0.232
	55	26	1	0.6	23.6	20.2	—	—	—	11 000	14 000	7006DB	7006DF	7006DT	37.5	11.5	35.5	—	49.5	50.5	1	0.6	0.266
	55	26	1	0.6	21.3	18.4	—	—	—	8 500	11 000	7006BDB	7006BDF	7006BDT	48.7	22.7	35.5	—	49.5	50.5	1	0.6	0.266
	55	26	1	0.6	25.7	22.0	—	—	14.9	16 000	21 000	7006CDB	7006CDF	7006CDT	24.4	1.6	35.5	—	49.5	50.5	1	0.6	0.266
	62	32	1	0.6	34.7	27.4	36.6	29.7	—	10 000	13 000	7206DB	7206DF	7206DT	43.0	11.0	35.5	34.5	56.5	57.5	1	0.6	0.416
	62	32	1	0.6	31.6	25.0	33.3	27.1	—	7 700	10 000	7206BDB	7206BDF	7206BDT	55.2	23.2	35.5	34.5	56.5	57.5	1	0.6	0.416
	62	32	1	0.6	37.4	29.5	39.5	32.0	14.0	14 000	19 000	7206CDB	7206CDF	7206CDT	28.5	3.5	35.5	34.5	56.5	57.5	1	0.6	0.416
	72	38	1.1	0.6	48.9	37.8	51.8	41.2	—	9 200	12 000	7306DB	7306DF	7306DT	49.0	11.0	37	34.5	65	67.5	1	0.6	0.724
	72	38	1.1	0.6	44.9	34.7	47.5	37.9	—	6 900	9 200	7306BDB	7306BDF	7306BDT	62.6	24.6	37	34.5	65	67.5	1	0.6	0.724
	72	38	1.1	0.6	52.5	40.5	55.6	44.2	13.4	13 000	17 000	7306CDB	7306CDF	7306CDT	32.9	5.1	37	34.5	65	67.5	1	0.6	0.724
	90	46	1.5	1	77.3	56.9	82.9	63.2	—	5 700	8 100	7406DB	7406DF	7406DT	58.5	12.5	38.5	35.5	81.5	84.5	1.5	1	1.37
	90	46	1.5	1	71.8	52.8	77.0	58.6	—	4 900	7 300	7406BDB	7406BDF	7406BDT	74.6	28.6	38.5	35.5	81.5	84.5	1.5	1	1.37
35	55	20	0.6	0.3	20.4	19.4	—	—	15.7	15 000	20 000	7907CDB	7907CDF	7907CDT	22.1	2.1	39.5	—	50.5	52.5	0.6	0.3	0.148
	62	28	1	0.6	15.0	11.1	—	—	8.1	18 000	28 000	HAR007CDB	HAR007CDF	HAR007CDT	27.0	1.0	40.5	—	56.5	57.5	1	0.6	0.316
	62	28	1	0.6	28.4	25.2	—	—	—	9 800	12 000	7007DB	7007DF	7007DT	42.3	14.3	40.5	—	56.5	57.5	1	0.6	0.340
	62	28	1	0.6	25.7	22.8	—	—	—	7 300	9 800	7007BDB	7007BDF	7007BDT	55.1	27.1	40.5	—	56.5	57.5	1	0.6	0.340
	62	28	1	0.6	31.0	27.4	—	—	15.0	13 000	18 000	7007CDB	7007CDF	7007CDT	27.0	1.0	40.5	—	56.5	57.5	1	0.6	0.340
	72	34	1.1	0.6	45.7	37.3	48.2	40.4	—	8 800	11 000	7207DB	7207DF	7207DT	48.5	14.5	42	39.5	65	67.5	1	0.6	0.590
	72	34	1.1	0.6	41.6	34.1	43.9	36.9	—	6 600	8 800	7207BDB	7207BDF	7207BDT	62.7	28.7	42	39.5	65	67.5	1	0.6	0.590
	72	34	1.1	0.6	49.4	40.2	52.1	43.5	14.0	12 000	16 000	7207CDB	7207CDF	7207CDT	31.6	2.4	42	39.5	65	67.5	1	0.6	0.590
	80	42	1.5	1	57.5	44.0	64.9	52.8	—	8 200	10 000	7307DB	7307DF	7307DT	54.8	12.8	43.5	40.5	71.5	74.5	1.5	1	0.950

[Notes] 1) Limiting speeds shown above are applicable to machined cage bearings. Limiting speeds of pressed cage bearings should be kept to under 80% of this value. For bearings with 15° contact angle, this figure is applied to the high precision bearings ranked higher than class 5, used with machined cages or molded cages.

2) B, C or no indication after the bearing number indicates nominal contact angle of 40°, 15° and 30° respectively. [Remark] Standard cage types used for the above bearings are described earlier in this section.

Angular contact ball bearings (matched pair)

d (35) ~ (45) mm

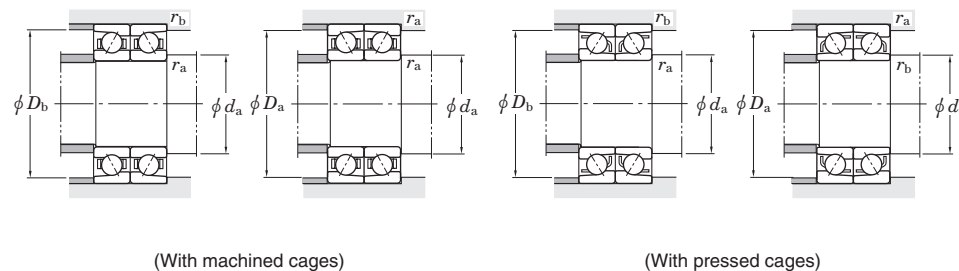
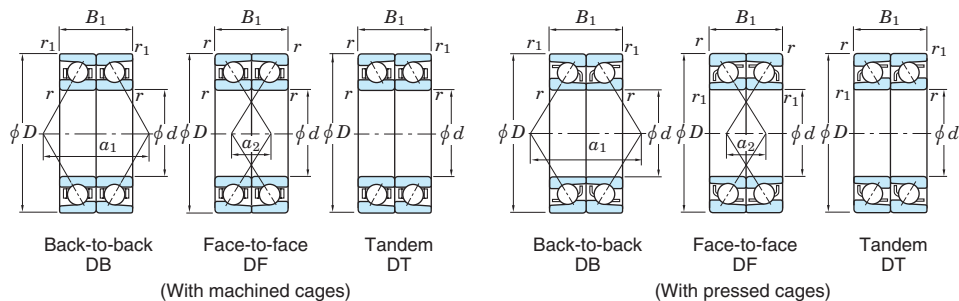

Boundary dimensions (mm)					Basic load ratings (kN)				Factor f_0	Limiting speeds ¹⁾ (min ⁻¹)		Bearing No. ²⁾			Load center spread (mm)		Mounting dimensions (mm)						(Refer.) Mass (kg)
d	D	B_1	$r_{min.}$	$r_{1min.}$	With machined cages		With pressed cages			Grease lub.	Oil lub.	Back-to-back DB	Face-to-face DF	Tandem DT	a_1	a_2	d_a min.	d_b min.	D_a max.	D_b max.	r_a max.	r_b max.	
35	80	42	1.5	1	52.7	40.5	59.5	48.6	—	6 200	8 200	7307BDB	7307BDF	7307BDT	70.1	28.1	43.5	40.5	71.5	74.5	1.5	1	0.950
	80	42	1.5	1	61.6	47.2	69.6	56.6	13.4	11 000	15 000	7307CDB	7307CDF	7307CDT	36.7	5.3	43.5	40.5	71.5	74.5	1.5	1	0.950
	100	50	1.5	1	98.2	73.9	105	82.1	—	5 000	7 200	7407DB	7407DF	7407DT	65.2	15.2	43.5	40.5	91.5	94.5	1.5	1	1.90
	100	50	1.5	1	91.3	68.6	97.9	76.2	—	4 300	6 500	7407BDB	7407BDF	7407BDT	83.3	33.3	43.5	40.5	91.5	94.5	1.5	1	1.90
40	62	24	0.6	0.3	25.6	24.9	—	—	15.7	13 000	18 000	7908CDB	7908CDF	7908CDT	25.7	1.7	44.5	—	57.5	59.5	0.6	0.3	0.214
	62	24	0.6	0.3	10.3	8.15	—	—	8.4	17 000	27 000	HAR908CDB	HAR908CDF	HAR908CDT	25.7	1.7	44.5	—	57.5	59.5	0.6	0.3	0.230
	68	30	1	0.6	15.8	12.4	—	—	8.2	16 000	25 000	HAR008CDB	HAR008CDF	HAR008CDT	29.5	0.5	45.5	—	62.5	63.5	1	0.6	0.400
	68	30	1	0.6	30.4	29.2	—	—	—	8 900	11 000	7008DB	7008DF	7008DT	46.3	16.3	45.5	—	62.5	63.5	1	0.6	0.420
	68	30	1	0.6	27.4	26.4	—	—	—	6 600	8 900	7008BDB	7008BDF	7008BDT	60.5	30.5	45.5	—	62.5	63.5	1	0.6	0.420
	68	30	1	0.6	33.4	31.8	—	—	15.4	12 000	16 000	7008CDB	7008CDF	7008CDT	29.5	0.5	45.5	—	62.5	63.5	1	0.6	0.420
	80	36	1.1	0.6	54.6	46.7	57.4	50.3	—	8 000	10 000	7208DB	7208DF	7208DT	52.7	16.7	47	44.5	73	75.5	1	0.6	0.764
	80	36	1.1	0.6	49.7	42.7	52.2	45.9	—	6 000	8 000	7208BDB	7208BDF	7208BDT	68.3	32.3	47	44.5	73	75.5	1	0.6	0.764
	80	36	1.1	0.6	59.1	50.4	62.0	54.3	14.2	11 000	15 000	7208CDB	7208CDF	7208CDT	34.1	1.9	47	44.5	73	75.5	1	0.6	0.764
	90	46	1.5	1	70.2	54.9	79.3	65.9	—	7 400	9 200	7308DB	7308DF	7308DT	60.5	14.5	48.5	45.5	81.5	84.5	1.5	1	1.31
	90	46	1.5	1	64.5	50.5	72.8	60.6	—	5 500	7 400	7308BDB	7308BDF	7308BDT	77.5	31.5	48.5	45.5	81.5	84.5	1.5	1	1.31
	90	46	1.5	1	75.3	58.8	85.0	70.5	13.4	10 000	14 000	7308CDB	7308CDF	7308CDT	40.4	5.6	48.5	45.5	81.5	84.5	1.5	1	1.31
110	54	2	1	114	87.1	122	96.8	—	4 600	6 600	7408DB	7408DF	7408DT	70.9	16.9	50	45.5	100	104.5	2	1	2.46	
110	54	2	1	105	80.8	113	89.8	—	3 900	5 900	7408BDB	7408BDF	7408BDT	90.8	36.8	50	45.5	100	104.5	2	1	2.46	
45	68	24	0.6	0.3	27.0	28.2	—	—	16.0	12 000	16 000	7909CDB	7909CDF	7909CDT	27.1	3.1	49.5	—	63.5	65.5	0.6	0.3	0.254
	68	24	0.6	0.3	11.0	9.35	—	—	8.5	16 000	24 000	HAR909CDB	HAR909CDF	HAR909CDT	27.1	3.1	49.5	—	63.5	65.5	0.6	0.3	0.272
	75	32	1	0.6	17.6	14.2	—	—	8.3	15 000	23 000	HAR009CDB	HAR009CDF	HAR009CDT	32.1	0.1	50.5	—	69.5	70.5	1	0.6	0.502
	75	32	1	0.6	36.2	35.4	—	—	—	8 000	10 000	7009DB	7009DF	7009DT	50.7	18.7	50.5	—	69.5	70.5	1	0.6	0.520
	75	32	1	0.6	32.5	32.0	—	—	—	6 000	8 000	7009BDB	7009BDF	7009BDT	66.3	34.3	50.5	—	69.5	70.5	1	0.6	0.520
	75	32	1	0.6	39.6	38.5	—	—	15.4	11 000	15 000	7009CDB	7009CDF	7009CDT	32.1	0.1	50.5	—	69.5	70.5	1	0.6	0.520
	85	38	1.1	0.6	61.3	53.2	64.4	57.2	—	7 500	9 400	7209DB	7209DF	7209DT	56.0	18.0	52	49.5	78	80.5	1	0.6	0.860
	85	38	1.1	0.6	55.8	48.6	58.6	52.3	—	5 600	7 500	7209BDB	7209BDF	7209BDT	72.8	34.8	52	49.5	78	80.5	1	0.6	0.860
	85	38	1.1	0.6	66.3	57.4	69.7	61.8	14.2	10 000	14 000	7209CDB	7209CDF	7209CDT	36.2	1.8	52	49.5	78	80.5	1	0.6	0.860

[Notes] 1) Limiting speeds shown above are applicable to machined cage bearings. Limiting speeds of pressed cage bearings should be kept to under 80% of this value. For bearings with 15° contact angle, this figure is applied to the high precision bearings ranked higher than class 5, used with machined cages or molded cages.

2) B, C or no indication after the bearing number indicates nominal contact angle of 40°, 15° and 30° respectively. [Remark] Standard cage types used for the above bearings are described earlier in this section.

Angular contact ball bearings (matched pair)

d (45) ~ (55) mm

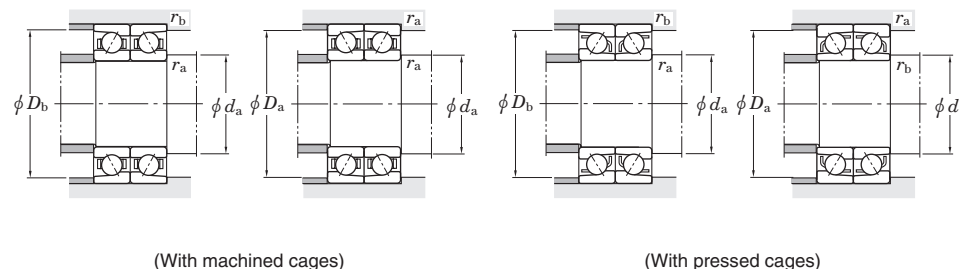
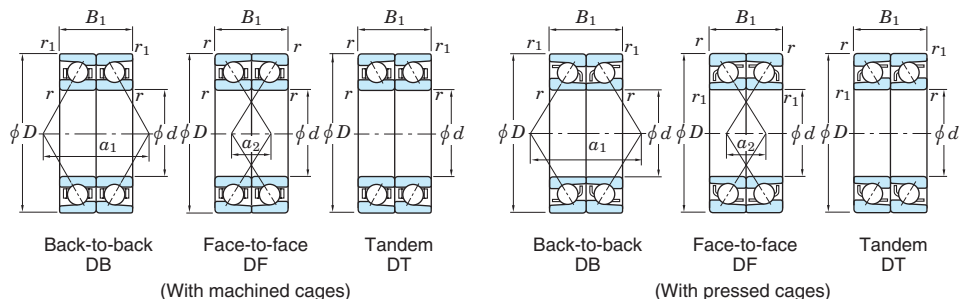

Boundary dimensions (mm)					Basic load ratings (kN)				Factor	Limiting speeds ¹⁾ (min ⁻¹)		Bearing No. ²⁾			Load center spread (mm)		Mounting dimensions (mm)						(Refer.) Mass (kg)
d	D	B ₁	r _{min.}	r _{1 min.}	With machined cages		With pressed cages			Grease lub.	Oil lub.	Back-to-back DB	Face-to-face DF	Tandem DT	a ₁	a ₂	d _{a min.}	d _{b min.}	D _{a max.}	D _{b max.}	r _{a max.}	r _{b max.}	
45	100	50	1.5	1	89.6	74.2	94.9	80.9	—	6 600	8 200	7309DB	7309DF	7309DT	67.2	17.2	53.5	50.5	91.5	94.5	1.5	1	1.75
	100	50	1.5	1	82.1	68.2	87.1	74.3	—	4 900	6 600	7309BDB	7309BDF	7309BDT	86.3	36.3	53.5	50.5	91.5	94.5	1.5	1	1.75
	100	50	1.5	1	96.1	79.5	102	86.7	13.5	9 000	12 000	7309CDB	7309CDF	7309CDT	44.6	5.4	53.5	50.5	91.5	94.5	1.5	1	1.75
	120	58	2	1	138	108	148	120	—	4 200	6 000	7409DB	7409DF	7409DT	77.2	19.2	55	50.5	110	114.5	2	1	3.10
	120	58	2	1	128	100	138	111	—	3 600	5 400	7409BDB	7409BDF	7409BDT	99.1	41.1	55	50.5	110	114.5	2	1	3.10
50	72	24	0.6	0.3	28.3	31.4	—	—	16.2	11 000	15 000	7910CDB	7910CDF	7910CDT	28.3	4.3	54.5	—	67.5	69.5	0.6	0.3	0.256
	72	24	0.6	0.3	14.8	12.6	—	—	8.5	14 000	22 000	HAR910CDB	HAR910CDF	HAR910CDT	28.3	4.3	54.5	—	67.5	69.5	0.6	0.3	0.262
	80	32	1	0.6	18.5	15.7	—	—	8.4	14 000	21 000	HAR010CDB	HAR010CDF	HAR010CDT	33.4	1.4	55.5	—	74.5	75.5	1	0.6	0.546
	80	32	1	0.6	38.4	40.2	—	—	—	7 300	9 200	7010DB	7010DF	7010DT	53.8	21.8	55.5	—	74.5	75.5	1	0.6	0.580
	80	32	1	0.6	34.5	36.2	—	—	—	5 500	7 400	7010BDB	7010BDF	7010BDT	70.5	38.5	55.5	—	74.5	75.5	1	0.6	0.580
	80	32	1	0.6	42.2	43.9	—	—	15.7	10 000	13 000	7010CDB	7010CDF	7010CDT	33.6	1.6	55.5	—	74.5	75.5	1	0.6	0.580
	90	40	1.1	0.6	64.0	58.7	67.0	62.9	—	6 800	8 500	7210DB	7210DF	7210DT	60.7	20.7	57	54.5	83	85.5	1	0.6	0.970
	90	40	1.1	0.6	58.0	53.5	60.7	57.3	—	5 100	6 800	7210BDB	7210BDF	7210BDT	79.2	39.2	57	54.5	83	85.5	1	0.6	0.970
	90	40	1.1	0.6	69.6	63.6	72.8	68.1	14.6	9 400	12 000	7210CDB	7210CDF	7210CDT	38.9	1.1	57	54.5	83	85.5	1	0.6	0.970
	110	54	2	1	114	96.3	121	105	—	5 800	7 300	7310DB	7310DF	7310DT	74.4	20.4	60	55.5	100	104.5	2	1	2.28
	110	54	2	1	105	88.6	111	96.6	—	4 400	5 800	7310BDB	7310BDF	7310BDT	95.8	41.8	60	55.5	100	104.5	2	1	2.28
	110	54	2	1	122	103	129	112	13.4	8 000	11 000	7310CDB	7310CDF	7310CDT	49.0	5.0	60	55.5	100	104.5	2	1	2.28
	130	62	2.1	1.1	158	131	—	—	—	3 800	5 500	7410DB	7410DF	7410DT	83.3	21.3	62	—	118	123	2	1	3.84
130	62	2.1	1.1	147	121	—	—	—	3 300	4 900	7410BDB	7410BDF	7410BDT	106.9	44.9	62	—	118	123	2	1	3.84	
55	80	26	1	0.6	32.0	37.0	—	—	16.3	10 000	14 000	7911CDB	7911CDF	7911CDT	31.1	5.1	60.5	—	74.5	75.5	1	0.6	0.356
	80	26	1	0.6	16.4	15.3	—	—	8.6	13 000	20 000	HAR911CDB	HAR911CDF	HAR911CDT	31.1	5.1	60.5	—	74.5	75.5	1	0.6	0.378
	90	36	1.1	0.6	22.9	19.8	—	—	8.4	12 000	19 000	HAR011CDB	HAR011CDF	HAR011CDT	37.4	1.4	62	—	83	85.5	1	0.6	0.806
	90	36	1.1	0.6	50.5	52.5	—	—	—	6 600	8 300	7011DB	7011DF	7011DT	59.9	23.9	62	—	83	85.5	1	0.6	0.840
	90	36	1.1	0.6	45.4	47.5	—	—	—	5 000	6 600	7011BDB	7011BDF	7011BDT	78.8	42.8	62	—	83	85.5	1	0.6	0.840
	90	36	1.1	0.6	55.4	57.3	—	—	15.5	9 100	12 000	7011CDB	7011CDF	7011CDT	37.4	1.4	62	—	83	85.5	1	0.6	0.840
	100	42	1.5	1	79.1	74.2	82.8	79.6	—	6 100	7 600	7211DB	7211DF	7211DT	66.6	24.6	63.5	60.5	91.5	94.5	1.5	1	1.27
	100	42	1.5	1	71.6	67.6	75.0	72.4	—	4 600	6 100	7211BDB	7211BDF	7211BDT	87.3	45.3	63.5	60.5	91.5	94.5	1.5	1	1.27

[Notes] 1) Limiting speeds shown above are applicable to machined cage bearings. Limiting speeds of pressed cage bearings should be kept to under 80% of this value. For bearings with 15° contact angle, this figure is applied to the high precision bearings ranked higher than class 5, used with machined cages or molded cages.

2) B, C or no indication after the bearing number indicates nominal contact angle of 40°, 15° and 30° respectively. [Remark] Standard cage types used for the above bearings are described earlier in this section.

Angular contact ball bearings (matched pair)

d (55) ~ (65) mm

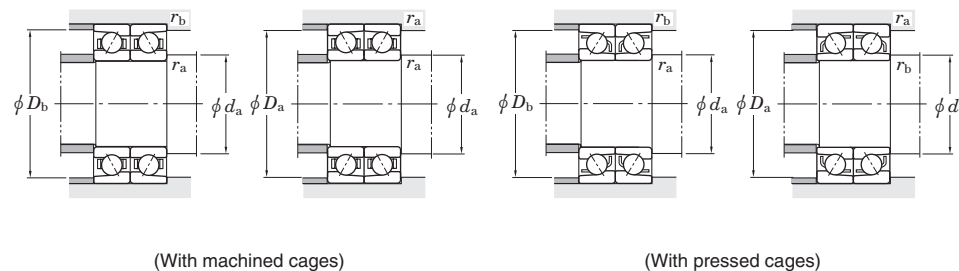
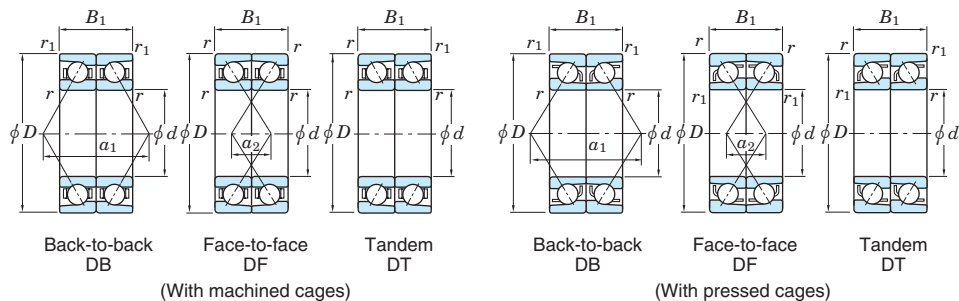

Boundary dimensions (mm)					Basic load ratings (kN)				Factor f_0	Limiting speeds ¹⁾ (min ⁻¹)		Bearing No. ²⁾			Load center spread (mm)		Mounting dimensions (mm)						(Refer.) Mass (kg)
d	D	B_1	$r_{min.}$	$r_{1min.}$	With machined cages		With pressed cages			Grease lub.	Oil lub.	Back-to-back DB	Face-to-face DF	Tandem DT	a_1	a_2	d_a min.	d_b min.	D_a max.	D_b max.	r_a max.	r_b max.	
55	100	42	1.5	1	85.9	80.4	90.0	86.1	14.6	8 400	11 000	7211CDB	7211CDF	7211CDT	42.2	0.2	63.5	60.5	91.5	94.5	1.5	1	1.27
	120	58	2	1	132	113	139	123	—	5 400	6 700	7311DB	7311DF	7311DT	80.4	22.4	65	60.5	110	114.5	2	1	2.90
	120	58	2	1	121	104	128	113	—	4 000	5 400	7311BDB	7311BDF	7311BDT	103.7	45.7	65	60.5	110	114.5	2	1	2.90
	120	58	2	1	141	121	149	132	13.4	7 400	9 800	7311CDB	7311CDF	7311CDT	52.9	5.1	65	60.5	110	114.5	2	1	2.90
	140	66	2.1	1.1	192	165	—	—	—	3 500	5 000	7411DB	7411DF	7411DT	89.9	23.9	67	—	128	133	2	1	4.72
	140	66	2.1	1.1	179	153	—	—	—	3 000	4 500	7411BDB	7411BDF	7411BDT	115.7	49.7	67	—	128	133	2	1	4.72
60	85	26	1	0.6	37.8	43.6	—	—	16.3	9 100	13 000	7912CDB	7912CDF	7912CDT	32.6	6.6	65.5	—	79.5	80.5	1	0.6	0.374
	85	26	1	0.6	16.2	15.5	—	—	8.6	12 000	19 000	HAR912CDB	HAR912CDF	HAR912CDT	32.4	6.4	65.5	—	79.5	80.5	1	0.6	0.404
	95	36	1.1	0.6	23.9	21.7	—	—	8.5	11 000	18 000	HAR012CDB	HAR012CDF	HAR012CDT	38.8	2.8	67	—	88	90.5	1	0.6	0.866
	95	36	1.1	0.6	51.8	56.1	—	—	—	6 200	7 700	7012DB	7012DF	7012DT	62.8	26.8	67	—	88	90.5	1	0.6	0.900
	95	36	1.1	0.6	46.4	50.7	—	—	—	4 600	6 200	7012BDB	7012BDF	7012BDT	83.0	47.0	67	—	88	90.5	1	0.6	0.900
	95	36	1.1	0.6	56.9	61.3	—	—	15.7	8 500	11 000	7012CDB	7012CDF	7012CDT	38.8	2.8	67	—	88	90.5	1	0.6	0.900
	110	44	1.5	1	95.7	91.5	100	98.0	—	5 500	6 900	7212DB	7212DF	7212DT	72.3	28.3	68.5	65.5	101.5	104.5	1.5	1	1.64
	110	44	1.5	1	86.8	83.3	90.8	89.2	—	4 100	5 500	7212BDB	7212BDF	7212BDT	95.0	51.0	68.5	65.5	101.5	104.5	1.5	1	1.64
	110	44	1.5	1	104	99.0	109	106	14.5	7 500	10 000	7212CDB	7212CDF	7212CDT	45.3	1.3	68.5	65.5	101.5	104.5	1.5	1	1.64
	130	62	2.1	1.1	150	131	159	143	—	5 000	6 200	7312DB	7312DF	7312DT	86.5	24.5	72	67	118	123	2	1	3.62
	130	62	2.1	1.1	138	121	146	132	—	3 700	5 000	7312BDB	7312BDF	7312BDT	111.6	49.6	72	67	118	123	2	1	3.62
	130	62	2.1	1.1	161	141	171	153	13.4	6 800	9 100	7312CDB	7312CDF	7312CDT	56.7	5.3	72	67	118	123	2	1	3.62
150	70	2.1	1.1	209	187	—	—	—	3 200	4 600	7412DB	7412DF	7412DT	97.0	27.0	72	—	138	143	2	1	5.70	
150	70	2.1	1.1	194	173	—	—	—	2 800	4 100	7412BDB	7412BDF	7412BDT	125.1	55.1	72	—	138	143	2	1	5.70	
65	90	26	1	0.6	33.7	42.3	—	—	16.5	8 600	12 000	7913CDB	7913CDF	7913CDT	33.8	7.8	70.5	—	84.5	85.5	1	0.6	0.410
	90	26	1	0.6	19.1	18.9	—	—	8.6	11 000	18 000	HAR913CDB	HAR913CDF	HAR913CDT	33.8	7.8	70.5	—	84.5	85.5	1	0.6	0.424
	100	36	1.1	0.6	24.8	23.5	—	—	8.5	11 000	16 000	HAR013CDB	HAR013CDF	HAR013CDT	40.1	4.1	72	—	93	95.5	1	0.6	0.924
	100	36	1.1	0.6	54.7	62.8	—	—	—	5 800	7 200	7013DB	7013DF	7013DT	65.9	29.9	72	—	93	95.5	1	0.6	0.940
	100	36	1.1	0.6	48.9	56.6	—	—	—	4 300	5 800	7013BDB	7013BDF	7013BDT	87.6	51.6	72	—	93	95.5	1	0.6	0.940
	100	36	1.1	0.6	60.2	68.7	—	—	15.9	7 900	11 000	7013CDB	7013CDF	7013CDT	40.2	4.2	72	—	93	95.5	1	0.6	0.940
	120	46	1.5	1	109	108	114	116	—	5 200	6 400	7213DB	7213DF	7213DT	76.4	30.4	73.5	70.5	111.5	114.5	1.5	1	2.04

[Notes] 1) Limiting speeds shown above are applicable to machined cage bearings. Limiting speeds of pressed cage bearings should be kept to under 80% of this value. For bearings with 15° contact angle, this figure is applied to the high precision bearings ranked higher than class 5, used with machined cages or molded cages.

2) B, C or no indication after the bearing number indicates nominal contact angle of 40°, 15° and 30° respectively. [Remark] Standard cage types used for the above bearings are described earlier in this section.

Angular contact ball bearings (matched pair)

d (65) ~ (75) mm

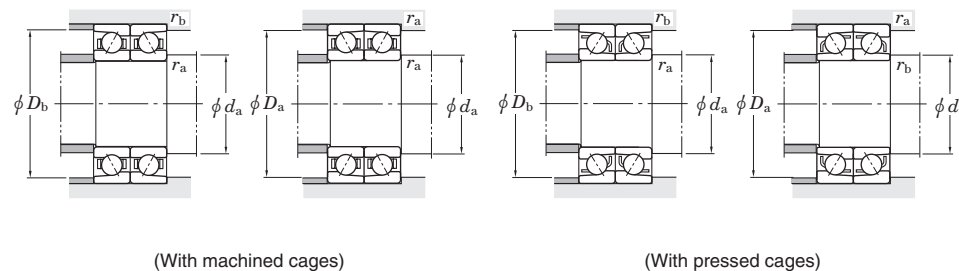
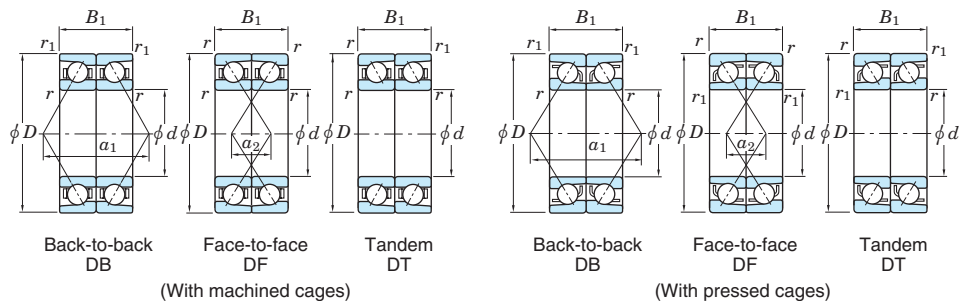

Boundary dimensions (mm)					Basic load ratings (kN)				Factor	Limiting speeds ¹⁾ (min ⁻¹)		Bearing No. ²⁾			Load center spread (mm)		Mounting dimensions (mm)						(Refer.) Mass (kg)
d	D	B ₁	r _{min.}	r _{1 min.}	With machined cages		With pressed cages			Grease lub.	Oil lub.	Back-to-back DB	Face-to-face DF	Tandem DT	a ₁	a ₂	d _{a min.}	d _{b min.}	D _{a max.}	D _{b max.}	r _{a max.}	r _{b max.}	
65	120	46	1.5	1	99.0	98.7	103	105	—	3 900	5 200	7213BDB	7213BDF	7213BDT	100.6	54.6	73.5	70.5	111.5	114.5	1.5	1	2.04
	120	46	1.5	1	119	117	124	125	14.6	7 100	9 400	7213CDB	7213CDF	7213CDT	47.8	1.8	73.5	70.5	111.5	114.5	1.5	1	2.04
	140	66	2.1	1.1	170	151	180	164	—	4 600	5 800	7313DB	7313DF	7313DT	92.5	26.5	77	72	128	133	2	1	4.44
	140	66	2.1	1.1	156	139	165	151	—	3 500	4 600	7313BDB	7313BDF	7313BDT	119.4	53.4	77	72	128	133	2	1	4.44
	140	66	2.1	1.1	182	161	193	176	13.4	6 300	8 500	7313CDB	7313CDF	7313CDT	60.6	5.4	77	72	128	133	2	1	4.44
	160	74	2.1	1.1	226	209	—	—	—	3 000	4 300	7413DB	7413DF	7413DT	102.9	28.9	77	—	148	153	2	1	6.82
	160	74	2.1	1.1	209	194	—	—	—	2 600	3 900	7413BDB	7413BDF	7413BDT	132.7	58.7	77	—	148	153	2	1	6.82
70	100	32	1	0.6	47.0	58.0	—	—	16.4	7 800	11 000	7914CDB	7914CDF	7914CDT	38.8	6.8	75.5	—	94.5	95.5	1	0.6	0.664
	100	32	1	0.6	20.9	20.9	—	—	8.7	10 000	16 000	HAR914CDB	HAR914CDF	HAR914CDT	38.8	6.8	75.5	—	94.5	95.5	1	0.6	0.712
	110	40	1.1	0.6	33.7	30.9	—	—	8.4	9 800	15 000	HAR014CDB	HAR014CDF	HAR014CDT	44.1	4.1	77	—	103	105.5	1	0.6	1.26
	110	40	1.1	0.6	69.3	78.7	—	—	—	5 300	6 600	7014DB	7014DF	7014DT	72.0	32.0	77	—	103	105.5	1	0.6	1.32
	110	40	1.1	0.6	62.1	71.1	—	—	—	4 000	5 300	7014BDB	7014BDF	7014BDT	95.5	55.5	77	—	103	105.5	1	0.6	1.32
	110	40	1.1	0.6	76.2	86.0	—	—	15.7	7 300	9 700	7014CDB	7014CDF	7014CDT	44.1	4.1	77	—	103	105.5	1	0.6	1.32
	125	48	1.5	1	113	111	124	127	—	4 900	6 100	7214DB	7214DF	7214DT	80.3	32.3	78.5	75.5	116.5	119.5	1.5	1	2.24
	125	48	1.5	1	103	101	112	116	—	3 700	4 900	7214BDB	7214BDF	7214BDT	105.8	57.8	78.5	75.5	116.5	119.5	1.5	1	2.24
	125	48	1.5	1	123	120	135	138	14.6	6 700	8 900	7214CDB	7214CDF	7214CDT	50.1	2.1	78.5	75.5	116.5	119.5	1.5	1	2.24
	150	70	2.1	1.1	191	172	203	187	—	4 300	5 400	7314DB	7314DF	7314DT	98.5	28.5	82	77	138	143	2	1	5.40
	150	70	2.1	1.1	175	158	186	172	—	3 200	4 300	7314BDB	7314BDF	7314BDT	127.3	57.3	82	77	138	143	2	1	5.40
	150	70	2.1	1.1	205	184	217	200	13.4	5 900	7 900	7314CDB	7314CDF	7314CDT	64.5	5.5	82	77	138	143	2	1	5.40
	180	84	3	1.1	242	230	—	—	—	2 700	3 900	7414DB	7414DF	7414DT	115.3	31.3	84	—	166	173	2.5	1	9.98
	180	84	3	1.1	241	237	—	—	—	2 300	3 500	7414BDB	7414BDF	7414BDT	148.4	64.4	84	—	166	173	2.5	1	9.98
75	105	32	1	0.6	47.7	60.9	—	—	16.5	7 400	9 800	7915CDB	7915CDF	7915CDT	40.1	8.1	80.5	—	99.5	100.5	1	0.6	0.700
	105	32	1	0.6	21.5	22.4	—	—	8.7	9 800	15 000	HAR915CDB	HAR915CDF	HAR915CDT	40.1	8.1	80.5	—	99.5	100.5	1	0.6	0.740
	115	40	1.1	0.6	34.3	32.4	—	—	8.5	9 300	14 000	HAR015CDB	HAR015CDF	HAR015CDT	45.5	5.5	82	—	108	110.5	1	0.6	1.33
	115	40	1.1	0.6	70.9	83.4	—	—	—	5 000	6 300	7015DB	7015DF	7015DT	74.9	34.9	82	—	108	110.5	1	0.6	1.38
	115	40	1.1	0.6	63.5	75.2	—	—	—	3 800	5 000	7015BDB	7015BDF	7015BDT	99.7	59.7	82	—	108	110.5	1	0.6	1.38
	115	40	1.1	0.6	78.0	91.3	—	—	15.9	6 900	9 200	7015CDB	7015CDF	7015CDT	45.5	5.5	82	—	108	110.5	1	0.6	1.38

[Notes] 1) Limiting speeds shown above are applicable to machined cage bearings. Limiting speeds of pressed cage bearings should be kept to under 80% of this value. For bearings with 15° contact angle, this figure is applied to the high precision bearings ranked higher than class 5, used with machined cages or molded cages.

2) B, C or no indication after the bearing number indicates nominal contact angle of 40°, 15° and 30° respectively. [Remark] Standard cage types used for the above bearings are described earlier in this section.

Angular contact ball bearings (matched pair)

d (75) ~ (85) mm

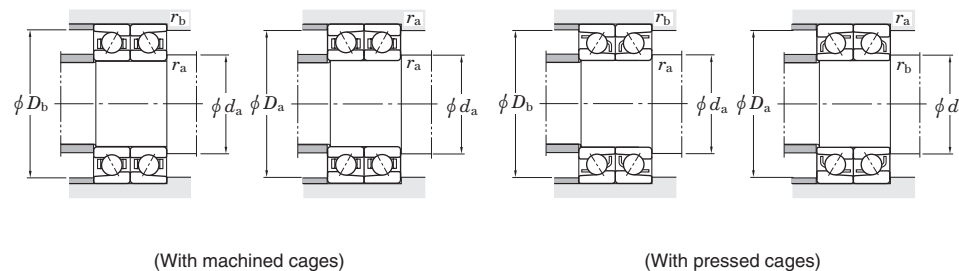
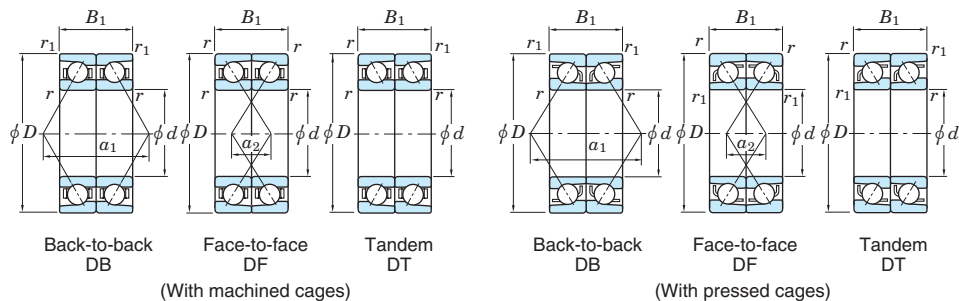

Boundary dimensions (mm)					Basic load ratings (kN)				Factor f_0	Limiting speeds ¹⁾ (min ⁻¹)		Bearing No. ²⁾			Load center spread (mm)		Mounting dimensions (mm)						(Refer.) Mass (kg)
d	D	B ₁	r _{min.}	r _{1 min.}	With machined cages		With pressed cages			Grease lub.	Oil lub.	Back-to-back DB	Face-to-face DF	Tandem DT	a ₁	a ₂	d _{a min.}	d _{b min.}	D _{a max.}	D _{b max.}	r _{a max.}	r _{b max.}	
75	130	50	1.5	1	129	130	134	139	—	4 600	5 800	7215DB	7215DF	7215DT	84.2	34.2	83.5	80.5	121.5	124.5	1.5	1	2.46
	130	50	1.5	1	116	119	122	127	—	3 500	4 600	7215BDB	7215BDF	7215BDT	111.0	61.0	83.5	80.5	121.5	124.5	1.5	1	2.46
	130	50	1.5	1	140	141	146	151	14.6	6 400	8 500	7215CDB	7215CDF	7215CDT	52.5	2.5	83.5	80.5	121.5	124.5	1.5	1	2.46
	160	74	2.1	1.1	208	194	221	212	—	4 000	5 000	7315DB	7315DF	7315DT	104.9	30.9	87	82	148	153	2	1	6.30
	160	74	2.1	1.1	191	178	202	195	—	3 000	4 000	7315BDB	7315BDF	7315BDT	135.6	61.6	87	82	148	153	2	1	6.30
	160	74	2.1	1.1	223	208	236	227	13.4	5 500	7 400	7315CDB	7315CDF	7315CDT	68.5	5.5	87	82	148	153	2	1	6.30
	190	90	3	1.1	278	282	—	—	—	2 500	3 600	7415DB	7415DF	7415DT	122.7	32.7	89	—	176	183	2.5	1	11.8
190	90	3	1.1	257	261	—	—	—	2 200	3 300	7415BDB	7415BDF	7415BDT	157.9	67.9	89	—	176	183	2.5	1	11.8	
80	110	32	1	0.6	48.4	63.2	—	—	16.5	7 000	9 300	7916CDB	7916CDF	7916CDT	41.5	9.5	85.5	—	104.5	105.5	1	0.6	0.736
	110	32	1	0.6	22.2	23.9	—	—	8.8	9 300	14 000	HAR916CDB	HAR916CDF	HAR916CDT	41.5	9.5	85.5	—	104.5	105.5	1	0.6	0.796
	125	44	1.1	0.6	40.1	38.5	—	—	8.4	8 200	13 000	HAR016CDB	HAR016CDF	HAR016CDT	49.5	5.5	87	—	118	120.5	1	0.6	1.81
	125	44	1.1	0.6	86.7	101	—	—	—	4 600	5 800	7016DB	7016DF	7016DT	81.2	37.2	87	—	118	120.5	1	0.6	1.86
	125	44	1.1	0.6	77.7	91.3	—	—	—	3 500	4 600	7016BDB	7016BDF	7016BDT	108.0	64.0	87	—	118	120.5	1	0.6	1.86
	125	44	1.1	0.6	95.3	111	—	—	15.7	6 400	8 500	7016CDB	7016CDF	7016CDT	49.5	5.5	87	—	118	120.5	1	0.6	1.86
	140	52	2	1	139	143	145	152	—	4 300	5 400	7216DB	7216DF	7216DT	89.5	37.5	90	85.5	130	134.5	2	1	3.00
	140	52	2	1	125	130	131	139	—	3 200	4 300	7216BDB	7216BDF	7216BDT	118.3	66.3	90	85.5	130	134.5	2	1	3.00
	140	52	2	1	151	155	157	165	14.7	5 900	7 900	7216CDB	7216CDF	7216CDT	55.5	3.5	90	85.5	130	134.5	2	1	3.00
	170	78	2.1	1.1	226	218	239	238	—	3 800	4 700	7316DB	7316DF	7316DT	111.2	33.2	92	87	158	163	2	1	7.70
	170	78	2.1	1.1	207	200	219	218	—	2 800	3 800	7316BDB	7316BDF	7316BDT	143.9	65.9	92	87	158	163	2	1	7.70
	170	78	2.1	1.1	242	233	256	255	13.5	5 200	6 900	7316CDB	7316CDF	7316CDT	72.5	5.5	92	87	158	163	2	1	7.70
	200	96	3	1.1	313	332	—	—	—	2 400	3 400	7416DB	7416DF	7416DT	130.0	34.0	94	—	186	193	2.5	1	12.0
	200	96	3	1.1	290	307	—	—	—	2 100	3 100	7416BDB	7416BDF	7416BDT	167.2	71.2	94	—	186	193	2.5	1	12.0
85	120	36	1.1	0.6	63.2	81.3	—	—	16.5	6 500	8 600	7917CDB	7917CDF	7917CDT	45.5	9.5	92	—	113	115.5	1	0.6	1.05
	120	36	1.1	0.6	26.6	28.4	—	—	8.7	8 200	13 000	HAR917CDB	HAR917CDF	HAR917CDT	45.5	9.5	92	—	113	115.5	1	0.6	1.14
	130	44	1.1	0.6	40.8	40.2	—	—	8.5	7 800	12 000	HAR017CDB	HAR017CDF	HAR017CDT	50.8	6.8	92	—	123	125.5	1	0.6	1.89
	130	44	1.1	0.6	88.6	107	—	—	—	4 400	5 500	7017DB	7017DF	7017DT	84.7	40.7	92	—	123	125.5	1	0.6	1.94
	130	44	1.1	0.6	79.3	96.7	—	—	—	3 300	4 400	7017BDB	7017BDF	7017BDT	113.0	69.0	92	—	123	125.5	1	0.6	1.94

[Notes] 1) Limiting speeds shown above are applicable to machined cage bearings. Limiting speeds of pressed cage bearings should be kept to under 80% of this value. For bearings with 15° contact angle, this figure is applied to the high precision bearings ranked higher than class 5, used with machined cages or molded cages.

2) B, C or no indication after the bearing number indicates nominal contact angle of 40°, 15° and 30° respectively. [Remark] Standard cage types used for the above bearings are described earlier in this section.

Angular contact ball bearings (matched pair)

d (85) ~ (95) mm

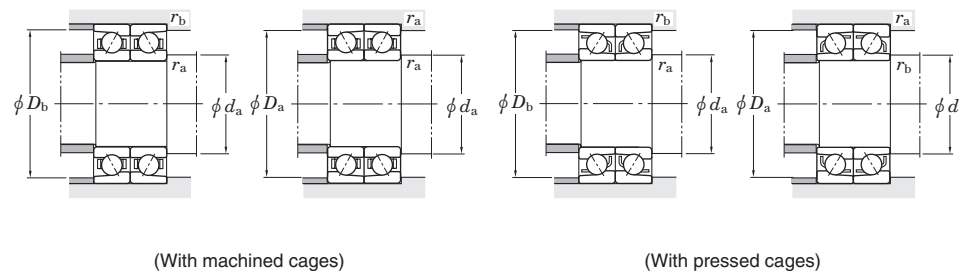
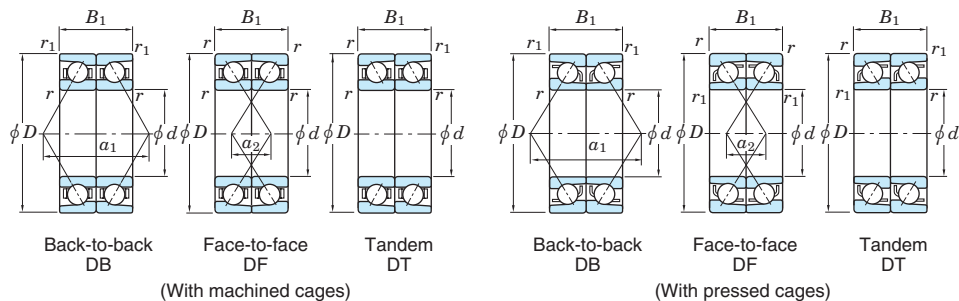

Boundary dimensions (mm)					Basic load ratings (kN)				Factor	Limiting speeds ¹⁾ (min ⁻¹)		Bearing No. ²⁾			Load center spread (mm)		Mounting dimensions (mm)						(Refer.) Mass (kg)
d	D	B ₁	r _{min.}	r _{1 min.}	With machined cages		With pressed cages			Grease lub.	Oil lub.	Back-to-back DB	Face-to-face DF	Tandem DT	a ₁	a ₂	d _{a min.}	d _{b min.}	D _{a max.}	D _{b max.}	r _{a max.}	r _{b max.}	
85	130	44	1.1	0.6	97.6	117	—	—	15.9	6 000	8 000	7017CDB	7017CDF	7017CDT	51.1	7.1	92	—	123	125.5	1	0.6	1.94
	150	56	2	1	160	167	167	178	—	4 000	5 000	7217DB	7217DF	7217DT	95.9	39.9	95	90.5	140	144.5	2	1	3.74
	150	56	2	1	145	152	151	162	—	3 000	4 000	7217BDB	7217BDF	7217BDT	126.6	70.6	95	90.5	140	144.5	2	1	3.74
	150	56	2	1	174	181	182	193	14.7	5 500	7 400	7217CDB	7217CDF	7217CDT	59.5	3.5	95	90.5	140	144.5	2	1	3.74
	180	82	3	1.1	243	243	258	265	—	3 500	4 400	7317DB	7317DF	7317DT	117.5	35.5	99	92	166	173	2.5	1	9.06
	180	82	3	1.1	223	223	236	244	—	2 700	3 500	7317BDB	7317BDF	7317BDT	152.2	70.2	99	92	166	173	2.5	1	9.06
	180	82	3	1.1	261	261	277	284	13.5	4 900	6 500	7317CDB	7317CDF	7317CDT	76.5	5.5	99	92	166	173	2.5	1	9.06
	210	104	4	1.5	331	360	—	—	—	2 300	3 300	7417DB	7417DF	7417DT	137.5	33.5	103	—	192	201.5	3	1.5	17.1
	210	104	4	1.5	307	334	—	—	—	2 000	3 000	7417BDB	7417BDF	7417BDT	176.2	72.2	103	—	192	201.5	3	1.5	17.1
	90	125	36	1.1	0.6	64.3	85.2	—	—	16.6	6 200	8 200	7918CDB	7918CDF	7918CDT	46.8	10.8	97	—	118	120.5	1	0.6
125		36	1.1	0.6	27.3	30.2	—	—	8.8	7 800	12 000	HAR918CDB	HAR918CDF	HAR918CDT	46.8	10.8	97	—	118	120.5	1	0.6	1.20
140		48	1.5	1	53.3	52.1	—	—	8.4	7 300	11 000	HAR018CDB	HAR018CDF	HAR018CDT	54.8	6.8	98.5	—	131.5	134.5	1.5	1	2.43
140		48	1.5	1	106	127	—	—	—	4 100	5 100	7018DB	7018DF	7018DT	90.4	42.4	98.5	—	131.5	134.5	1.5	1	2.52
140		48	1.5	1	94.9	114	—	—	—	3 100	4 100	7018BDB	7018BDF	7018BDT	120.5	72.5	98.5	—	131.5	134.5	1.5	1	2.52
140		48	1.5	1	116	138	—	—	15.7	5 700	7 500	7018CDB	7018CDF	7018CDT	54.8	6.8	98.5	—	131.5	134.5	1.5	1	2.52
160		60	2	1	183	193	191	206	—	3 800	4 700	7218DB	7218DF	7218DT	102.2	42.2	100	95.5	150	154.5	2	1	4.60
160		60	2	1	166	176	173	188	—	2 800	3 800	7218BDB	7218BDF	7218BDT	134.9	74.9	100	95.5	150	154.5	2	1	4.60
160		60	2	1	199	209	208	223	14.6	5 200	6 900	7218CDB	7218CDF	7218CDT	63.5	3.5	100	95.5	150	154.5	2	1	4.60
190		86	3	1.1	261	270	277	294	—	3 300	4 200	7318DB	7318DF	7318DT	123.9	37.9	104	97	176	183	2.5	1	10.6
190		86	3	1.1	240	248	254	270	—	2 500	3 300	7318BDB	7318BDF	7318BDT	160.5	74.5	104	97	176	183	2.5	1	10.6
190		86	3	1.1	281	289	297	315	13.5	4 600	6 100	7318CDB	7318CDF	7318CDT	80.5	5.5	104	97	176	183	2.5	1	10.6
225		108	4	1.5	351	393	—	—	—	2 100	3 100	7418DB	7418DF	7418DT	145.0	37.0	108	—	207	216.5	3	1.5	22.8
225		108	4	1.5	325	364	—	—	—	1 800	2 800	7418BDB	7418BDF	7418BDT	186.2	78.2	108	—	207	216.5	3	1.5	22.8
95		130	36	1.1	0.6	65.3	88.3	—	—	16.5	5 900	7 900	7919CDB	7919CDF	7919CDT	48.1	12.1	102	—	123	125.5	1	0.6
	130	36	1.1	0.6	28.1	32.1	—	—	8.8	7 400	11 000	HAR919CDB	HAR919CDF	HAR919CDT	48.1	12.1	102	—	123	125.5	1	0.6	1.25
	145	48	1.5	1	54.3	54.4	—	—	8.5	7 000	11 000	HAR019CDB	HAR019CDF	HAR019CDT	56.2	8.2	103.5	—	136.5	139.5	1.5	1	2.56
	145	48	1.5	1	108	134	—	—	—	3 900	4 800	7019DB	7019DF	7019DT	94.5	46.5	103.5	—	136.5	139.5	1.5	1	2.64

[Notes] 1) Limiting speeds shown above are applicable to machined cage bearings. Limiting speeds of pressed cage bearings should be kept to under 80% of this value. For bearings with 15° contact angle, this figure is applied to the high precision bearings ranked higher than class 5, used with machined cages or molded cages.

2) B, C or no indication after the bearing number indicates nominal contact angle of 40°, 15° and 30° respectively. [Remark] Standard cage types used for the above bearings are described earlier in this section.

Angular contact ball bearings (matched pair)

d (95) ~ (105) mm

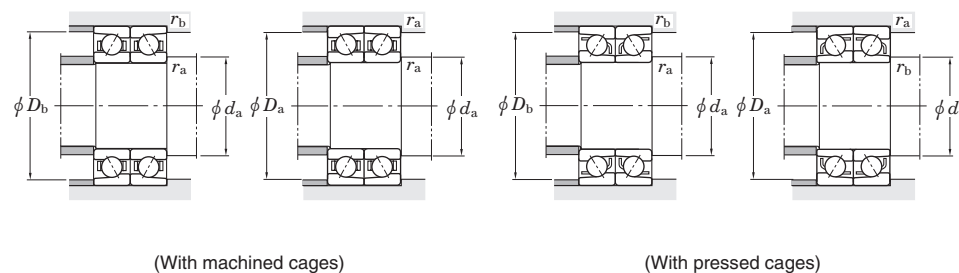
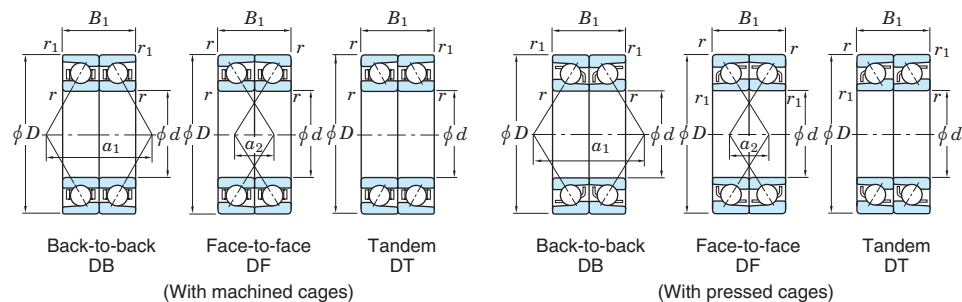

Boundary dimensions (mm)					Basic load ratings (kN)				Factor f_0	Limiting speeds ¹⁾ (min ⁻¹)		Bearing No. ²⁾			Load center spread (mm)		Mounting dimensions (mm)						(Refer.) Mass (kg)
d	D	B_1	$r_{min.}$	$r_{1min.}$	With machined cages		With pressed cages			Grease lub.	Oil lub.	Back-to-back DB	Face-to-face DF	Tandem DT	a_1	a_2	d_a min.	d_b min.	D_a max.	D_b max.	r_a max.	r_b max.	
95	145	48	1.5	1	96.8	121	—	—	—	2 900	3 900	7019BDB	7019BDF	7019BDT	126.4	78.4	103.5	—	136.5	139.5	1.5	1	2.64
	145	48	1.5	1	119	147	—	—	15.9	5 300	7 100	7019CDB	7019CDF	7019CDT	56.7	8.7	103.5	—	136.5	139.5	1.5	1	2.64
	170	64	2.1	1.1	198	207	208	221	—	3 500	4 400	7219DB	7219DF	7219DT	108.5	44.5	107	102	158	163	2	1	5.56
	170	64	2.1	1.1	180	188	188	201	—	2 700	3 500	7219BDB	7219BDF	7219BDT	143.2	79.2	107	102	158	163	2	1	5.56
	170	64	2.1	1.1	216	224	226	240	14.6	4 900	6 500	7219CDB	7219CDF	7219CDT	67.5	3.5	107	102	158	163	2	1	5.56
	200	90	3	1.1	280	298	297	325	—	3 200	4 000	7319DB	7319DF	7319DT	130.2	40.2	109	102	186	193	2.5	1	12.2
	200	90	3	1.1	256	273	272	298	—	2 400	3 200	7319BDB	7319BDF	7319BDT	168.8	78.8	109	102	186	193	2.5	1	12.2
	200	90	3	1.1	300	319	318	348	13.5	4 400	5 800	7319CDB	7319CDF	7319CDT	84.5	5.5	109	102	186	193	2.5	1	12.2
100	140	40	1.1	0.6	90.2	117	—	—	16.3	5 500	7 400	7920CDB	7920CDF	7920CDT	52.1	12.1	107	—	133	135.5	1	0.6	1.55
	140	40	1.1	0.6	39.2	43.5	—	—	8.7	7 000	11 000	HAR920CDB	HAR920CDF	HAR920CDT	52.2	12.2	107	—	133	135.5	1	0.6	1.68
	150	48	1.5	1	55.2	56.7	—	—	8.5	6 700	10 000	HAR020CDB	HAR020CDF	HAR020CDT	57.5	9.5	108.5	—	141.5	144.5	1.5	1	2.64
	150	48	1.5	1	111	141	—	—	—	3 800	4 700	7020DB	7020DF	7020DT	96.2	48.2	108.5	—	141.5	144.5	1.5	1	2.74
	150	48	1.5	1	99.4	127	—	—	—	2 800	3 800	7020BDB	7020BDF	7020BDT	128.9	80.9	108.5	—	141.5	144.5	1.5	1	2.74
	150	48	1.5	1	122	154	—	—	16.0	5 200	6 900	7020CDB	7020CDF	7020CDT	57.5	9.5	108.5	—	141.5	144.5	1.5	1	2.74
	180	68	2.1	1.1	223	235	233	252	—	3 300	4 100	7220DB	7220DF	7220DT	115.4	47.4	112	—	168	173	2	1	6.64
	180	68	2.1	1.1	202	214	211	229	—	2 500	3 300	7220BDB	7220BDF	7220BDT	152.3	84.3	112	—	168	173	2	1	6.64
	180	68	2.1	1.1	242	254	254	273	14.6	4 600	6 100	7220CDB	7220CDF	7220CDT	71.8	3.8	112	107	168	173	2	1	6.64
	215	94	3	1.1	298	323	337	387	—	2 900	3 600	7320DB	7320DF	7320DT	138.8	44.8	114	—	201	208	2.5	1	15.1
	215	94	3	1.1	274	297	309	356	—	2 200	2 900	7320BDB	7320BDF	7320BDT	180.4	86.4	114	—	201	208	2.5	1	15.1
	215	94	3	1.1	320	346	361	415	13.4	4 000	5 300	7320CDB	7320CDF	7320CDT	89.6	4.4	114	107	201	208	2.5	1	15.1
105	145	40	1.1	0.6	92.1	123	—	—	16.4	5 300	7 100	7921CDB	7921CDF	7921CDT	53.5	13.5	112	—	138	140.5	1	0.6	1.62
	145	40	1.1	0.6	40.4	46.2	—	—	8.7	6 700	10 000	HAR921CDB	HAR921CDF	HAR921CDT	53.5	13.5	112	—	138	140.5	1	0.6	1.75
	160	52	2	1	62.6	65.1	—	—	8.5	6 300	9 800	HAR021CDB	HAR021CDF	HAR021CDT	61.5	9.5	115	—	150	154.5	2	1	3.37
	160	52	2	1	130	164	—	—	—	3 500	4 400	7021DB	7021DF	7021DT	103.7	51.7	115	—	150	154.5	2	1	3.46
	160	52	2	1	116	148	—	—	—	2 600	3 500	7021BDB	7021BDF	7021BDT	137.2	85.2	115	—	150	154.5	2	1	3.46
	160	52	2	1	143	179	—	—	15.9	4 800	6 400	7021CDB	7021CDF	7021CDT	62.0	10.0	115	—	150	154.5	2	1	3.46
	190	72	2.1	1.1	243	265	—	—	—	3 100	3 900	7221DB	7221DF	7221DT	122.1	50.1	117	—	178	183	2	1	7.90

[Notes] 1) Limiting speeds shown above are applicable to machined cage bearings. Limiting speeds of pressed cage bearings should be kept to under 80% of this value. For bearings with 15° contact angle, this figure is applied to the high precision bearings ranked higher than class 5, used with machined cages or molded cages.

2) B, C or no indication after the bearing number indicates nominal contact angle of 40°, 15° and 30° respectively. [Remark] Standard cage types used for the above bearings are described earlier in this section.

Angular contact ball bearings (matched pair)

d (105) ~ (120) mm

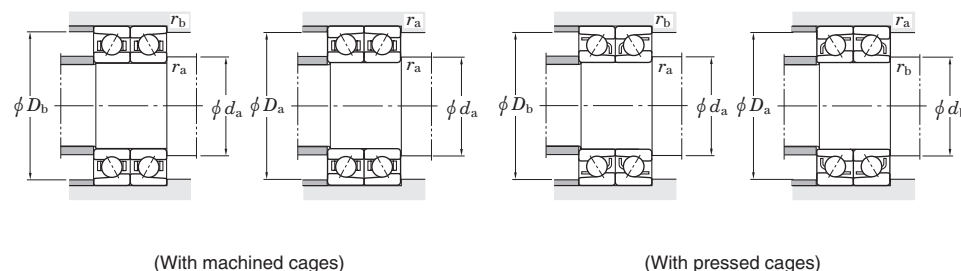
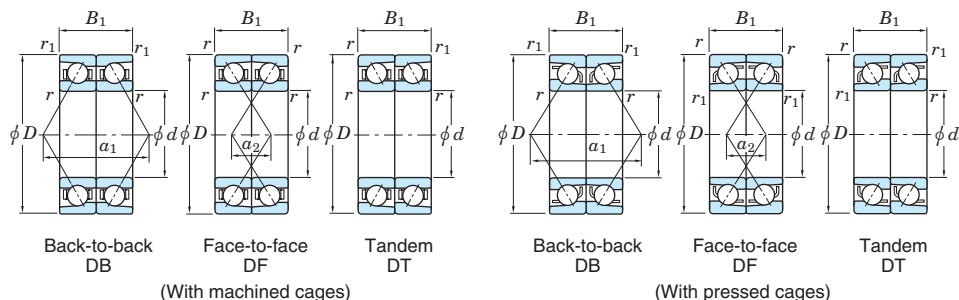

Boundary dimensions (mm)					Basic load ratings (kN)				Factor	Limiting speeds ¹⁾ (min ⁻¹)		Bearing No. ²⁾			Load center spread (mm)		Mounting dimensions (mm)						(Refer.) Mass (kg)
d	D	B ₁	r _{min.}	r _{1 min.}	With machined cages		With pressed cages			Grease lub.	Oil lub.	Back-to-back DB	Face-to-face DF	Tandem DT	α ₁	α ₂	d _{a min.}	d _{b min.}	D _{a max.}	D _{b max.}	r _{a max.}	r _{b max.}	
105	190	72	2.1	1.1	220	241	—	—	—	2 300	3 100	7221BDB	7221BDF	7221BDT	161.0	89.0	117	—	178	183	2	1	7.90
	190	72	2.1	1.1	264	287	—	—	14.6	4 300	5 700	7221CDB	7221CDF	7221CDT	75.9	3.9	117	—	178	183	2	1	7.90
	225	98	3	1.1	337	386	—	—	—	2 800	3 500	7321DB	7321DF	7321DT	144.3	46.3	119	—	211	218	2.5	1	17.2
	225	98	3	1.1	310	355	—	—	—	2 100	2 800	7321BDB	7321BDF	7321BDT	187.5	89.5	119	—	211	218	2.5	1	17.2
	225	98	3	1.1	362	413	—	—	13.4	3 900	5 100	7321CDB	7321CDF	7321CDT	93.2	4.8	119	—	211	218	2.5	1	17.2
110	150	40	1.1	0.6	93.8	129	—	—	16.5	5 100	6 800	7922CDB	7922CDF	7922CDT	54.8	14.8	117	—	143	145.5	1	0.6	1.68
	150	40	1.1	0.6	40.8	47.7	—	—	8.7	6 400	9 900	HAR922CDB	HAR922CDF	HAR922CDT	54.8	14.8	117	—	143	145.5	1	0.6	1.82
	170	56	2	1	70.5	73.9	—	—	8.5	6 000	9 200	HAR022CDB	HAR022CDF	HAR022CDT	65.5	9.5	120	—	160	164.5	2	1	4.22
	170	56	2	1	149	186	—	—	—	3 300	4 200	7022DB	7022DF	7022DT	108.9	52.9	120	—	160	164.5	2	1	4.28
	170	56	2	1	134	167	—	—	—	2 500	3 300	7022BDB	7022BDF	7022BDT	145.5	89.5	120	—	160	164.5	2	1	4.28
	170	56	2	1	164	203	—	—	15.7	4 600	6 100	7022CDB	7022CDF	7022CDT	65.5	9.5	120	—	160	164.5	2	1	4.28
	200	76	2.1	1.1	263	297	—	—	—	3 000	3 700	7222DB	7222DF	7222DT	128.7	52.7	122	—	188	193	2	1	9.30
	200	76	2.1	1.1	238	270	—	—	—	2 200	3 000	7222BDB	7222BDF	7222BDT	169.7	93.7	122	—	188	193	2	1	9.30
	200	76	2.1	1.1	286	321	—	—	14.5	4 100	5 400	7222CDB	7222CDF	7222CDT	80.1	4.1	122	—	188	193	2	1	9.30
	240	100	3	1.1	377	452	—	—	—	2 600	3 200	7322DB	7322DF	7322DT	152.7	52.7	124	—	226	233	2.5	1	20.2
	240	100	3	1.1	346	416	—	—	—	1 900	2 600	7322BDB	7322BDF	7322BDT	199.3	99.3	124	—	226	233	2.5	1	20.2
	240	100	3	1.1	404	484	—	—	13.4	3 500	4 700	7322CDB	7322CDF	7322CDT	97.7	2.3	124	—	226	233	2.5	1	20.2
	120	165	44	1.1	0.6	117	162	—	—	16.5	4 700	6 200	7924CDB	7924CDF	7924CDT	60.2	16.2	127	—	158	160.5	1	0.6
165		44	1.1	0.6	47.7	56.8	—	—	8.8	5 900	9 100	HAR924CDB	HAR924CDF	HAR924CDT	60.2	16.2	127	—	158	160.5	1	0.6	2.49
180		56	2	1	72.9	79.9	—	—	8.5	5 600	8 600	HAR024CDB	HAR024CDF	HAR024CDT	68.2	12.2	130	—	170	174.5	2	1	4.52
180		56	2	1	157	206	—	—	—	3 100	3 900	7024DB	7024DF	7024DT	114.6	58.6	130	—	170	174.5	2	1	4.54
180		56	2	1	140	186	—	—	—	2 300	3 100	7024BDB	7024BDF	7024BDT	153.9	97.9	130	—	170	174.5	2	1	4.54
180		56	2	1	173	226	—	—	16.0	4 300	5 700	7024CDB	7024CDF	7024CDT	68.2	12.2	130	—	170	174.5	2	1	4.54
215		80	2.1	1.1	283	332	—	—	—	2 700	3 400	7224DB	7224DF	7224DT	137.0	57.0	132	—	203	208	2	1	11.0
215		80	2.1	1.1	257	302	—	—	—	2 100	2 800	7224BDB	7224BDF	7224BDT	180.5	100.5	132	—	203	208	2	1	11.0
215		80	2.1	1.1	308	359	—	—	14.6	3 800	5 000	7224CDB	7224CDF	7224CDT	85.0	5.0	132	—	203	208	2	1	11.0
260		110	3	1.1	400	504	—	—	—	2 400	3 000	7324DB	7324DF	7324DT	164.7	54.7	134	—	246	253	2.5	1	25.2

[Notes] 1) Limiting speeds shown above are applicable to machined cage bearings. Limiting speeds of pressed cage bearings should be kept to under 80% of this value. For bearings with 15° contact angle, this figure is applied to the high precision bearings ranked higher than class 5, used with machined cages or molded cages.

2) B, C or no indication after the bearing number indicates nominal contact angle of 40°, 15° and 30° respectively. [Remark] Standard cage types used for the above bearings are described earlier in this section.

Angular contact ball bearings (matched pair)

d (120) ~ (150) mm

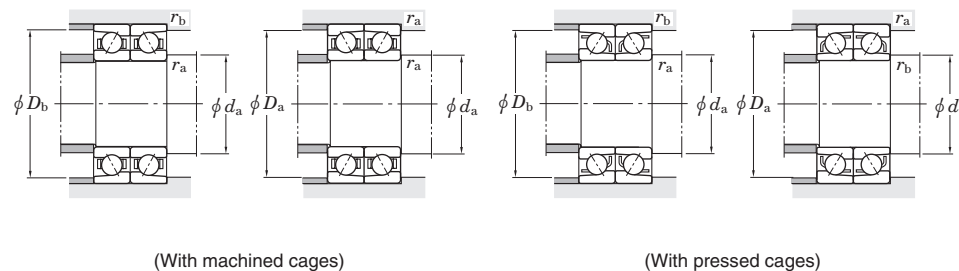
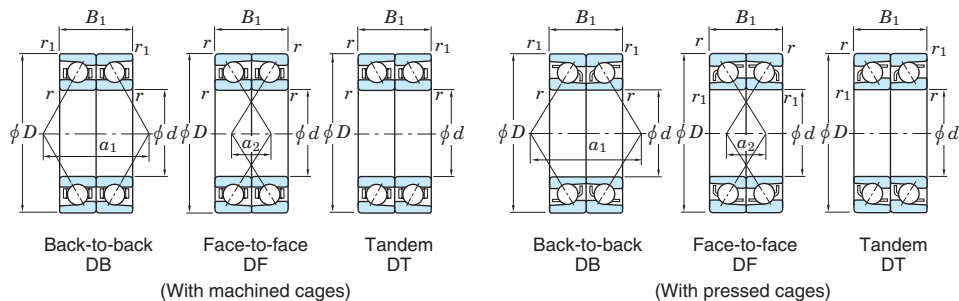

Boundary dimensions (mm)					Basic load ratings (kN)				Factor	Limiting speeds ¹⁾ (min ⁻¹)		Bearing No. ²⁾			Load center spread (mm)		Mounting dimensions (mm)						(Refer.) Mass (kg)
d	D	B ₁	r _{min.}	r _{1 min.}	With machined cages		With pressed cages			Grease lub.	Oil lub.	Back-to-back DB	Face-to-face DF	Tandem DT	a ₁	a ₂	d _{a min.}	d _{b min.}	D _{a max.}	D _{b max.}	r _{a max.}	r _{b max.}	
120	260	110	3	1.1	366	462	—	—	—	1 800	2 400	7324BDB	7324BDF	7324BDT	214.4	104.4	134	—	246	253	2.5	1	25.2
	260	110	3	1.1	431	542	—	—	13.7	3 300	4 400	7324CDB	7324CDF	7324CDT	105.9	4.1	134	—	246	253	2.5	1	25.2
130	180	48	1.5	1	142	200	—	—	16.4	4 300	5 700	7926CDB	7926CDF	7926CDT	65.5	17.5	138.5	—	171.5	174.5	1.5	1	3.00
	180	48	1.5	1	57.0	70.3	—	—	8.8	5 400	8 300	HAR926CDB	HAR926CDF	HAR926CDT	65.5	17.5	138.5	—	171.5	174.5	1.5	1	3.32
	200	66	2	1	91.5	96.7	—	—	8.5	5 100	7 800	HAR026CDB	HAR026CDF	HAR026CDT	77.2	11.2	140	—	190	194.5	2	1	6.77
	200	66	2	1	191	251	—	—	—	2 800	3 500	7026DB	7026DF	7026DT	128.3	62.3	140	—	190	194.5	2	1	6.86
	200	66	2	1	171	226	—	—	—	2 100	2 800	7026BDB	7026BDF	7026BDT	171.5	105.5	140	—	190	194.5	2	1	6.86
	200	66	2	1	210	274	—	—	15.9	3 900	5 100	7026CDB	7026CDF	7026CDT	77.2	11.2	140	—	190	194.5	2	1	6.86
	230	80	3	1.1	318	395	—	—	—	2 500	3 200	7226DB	7226DF	7226DT	143.9	63.9	144	—	216	223	2.5	1	12.4
	230	80	3	1.1	288	360	—	—	—	1 900	2 500	7226BDB	7226BDF	7226BDT	191.0	111.0	144	—	216	223	2.5	1	12.4
	230	80	3	1.1	346	428	—	—	14.7	3 500	4 700	7226CDB	7226CDF	7226CDT	88.2	8.2	144	—	216	223	2.5	1	12.4
	280	116	4	1.5	489	659	—	—	—	2 200	2 700	7326DB	7326DF	7326DT	177.5	61.5	148	—	262	271.5	3	1.5	30.8
	280	116	4	1.5	406	536	—	—	—	1 600	2 200	7326BDB	7326BDF	7326BDT	230.0	114.0	148	—	262	271.5	3	1.5	30.8
	280	116	4	1.5	478	629	—	—	13.7	3 000	4 000	7326CDB	7326CDF	7326CDT	112.9	3.1	148	—	262	271.5	3	1.5	30.8
140	190	48	1.5	1	143	210	—	—	16.6	4 000	5 400	7928CDB	7928CDF	7928CDT	68.2	20.2	148.5	—	181.5	184.5	1.5	1	3.18
	190	48	1.5	1	57.2	72.4	—	—	8.8	5 100	7 800	HAR928CDB	HAR928CDF	HAR928CDT	68.2	20.2	148.5	—	181.5	184.5	1.5	1	3.52
	210	66	2	1	99.6	112	—	—	8.5	4 800	7 400	HAR028CDB	HAR028CDF	HAR028CDT	79.9	13.9	150	—	200	204.5	2	1	7.24
	210	66	2	1	194	265	—	—	—	2 600	3 300	7028DB	7028DF	7028DT	134.1	68.1	150	—	200	204.5	2	1	7.28
	210	66	2	1	174	237	—	—	—	2 000	2 600	7028BDB	7028BDF	7028BDT	179.8	113.8	150	—	200	204.5	2	1	7.28
	210	66	2	1	214	290	—	—	16.0	3 600	4 800	7028CDB	7028CDF	7028CDT	79.9	13.9	150	—	200	204.5	2	1	7.28
	250	84	3	1.1	355	468	—	—	—	2 300	2 900	7228DB	7228DF	7228DT	154.6	70.6	154	—	236	243	2.5	1	15.5
	250	84	3	1.1	320	426	—	—	—	1 700	2 300	7228BDB	7228BDF	7228BDT	205.6	121.6	154	—	236	243	2.5	1	15.5
	250	84	3	1.1	386	508	—	—	14.8	3 200	4 300	7228CDB	7228CDF	7228CDT	94.2	10.2	154	—	236	243	2.5	1	15.5
	300	124	4	1.5	535	748	—	—	—	2 000	2 500	7328DB	7328DF	7328DT	189.0	65.0	158	—	282	291.5	3	1.5	37.6
	300	124	4	1.5	491	688	—	—	—	1 500	2 000	7328BDB	7328BDF	7328BDT	246.6	122.6	158	—	282	291.5	3	1.5	37.6
	300	124	4	1.5	573	802	—	—	13.4	2 800	3 700	7328CDB	7328CDF	7328CDT	120.9	3.1	158	—	282	291.5	3	1.5	37.6
150	210	56	2	1	187	263	—	—	16.3	3 700	4 900	7930CDB	7930CDF	7930CDT	76.2	20.2	160	—	200	204.5	2	1	4.94

[Notes] 1) Limiting speeds shown above are applicable to machined cage bearings. Limiting speeds of pressed cage bearings should be kept to under 80% of this value. For bearings with 15° contact angle, this figure is applied to the high precision bearings ranked higher than class 5, used with machined cages or molded cages.

2) B, C or no indication after the bearing number indicates nominal contact angle of 40°, 15° and 30° respectively. [Remark] Standard cage types used for the above bearings are described earlier in this section.

Angular contact ball bearings (matched pair)

d (150) ~ (170) mm

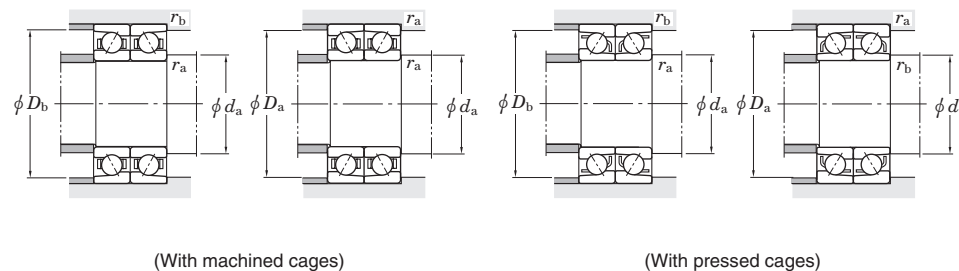
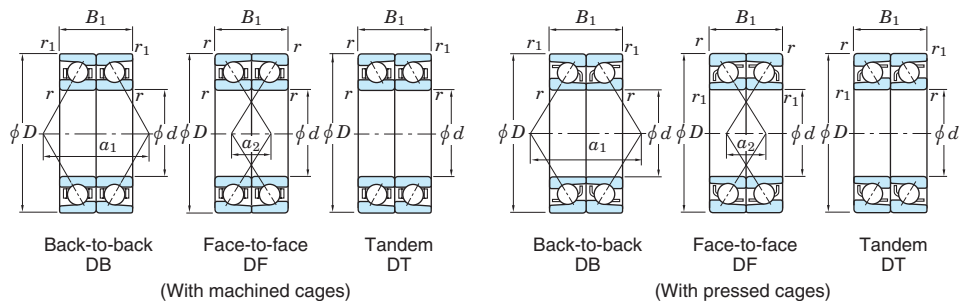

Boundary dimensions (mm)					Basic load ratings (kN)				Factor f_0	Limiting speeds ¹⁾ (min ⁻¹)		Bearing No. ²⁾			Load center spread (mm)		Mounting dimensions (mm)						(Refer.) Mass (kg)
d	D	B_1	$r_{min.}$	$r_{1 min.}$	With machined cages		With pressed cages			Grease lub.	Oil lub.	Back-to-back DB	Face-to-face DF	Tandem DT	a_1	a_2	d_a min.	d_b min.	D_a max.	D_b max.	r_a max.	r_b max.	
150	210	56	2	1	79.5	97.7	—	—	8.7	4 600	7 200	HAR930CDB	HAR930CDF	HAR930CDT	76.2	20.2	160	—	200	204.5	2	1	5.36
	225	70	2	1	117	132	—	—	8.5	4 200	6 500	HAR030CDB	HAR030CDF	HAR030CDT	85.2	15.2	160	—	215	219.5	2	1	8.72
	225	70	2.1	1.1	222	308	—	—	—	2 400	3 000	7030DB	7030DF	7030DT	144.2	74.2	162	—	213	218	2	1	8.86
	225	70	2.1	1.1	199	275	—	—	—	1 800	2 400	7030BDB	7030BDF	7030BDT	192.3	122.3	162	—	213	218	2	1	8.86
	225	70	2.1	1.1	245	337	—	—	16.1	3 300	4 400	7030CDB	7030CDF	7030CDT	85.6	15.6	162	—	213	218	2	1	8.86
	270	90	3	1.1	403	560	—	—	—	2 100	2 700	7230DB	7230DF	7230DT	166.3	76.3	164	—	256	263	2.5	1	19.5
	270	90	3	1.1	365	509	—	—	—	1 600	2 100	7230BDB	7230BDF	7230BDT	221.2	131.2	164	—	256	263	2.5	1	19.5
	270	90	3	1.1	439	607	—	—	14.7	2 900	3 900	7230CDB	7230CDF	7230CDT	101.3	11.3	164	—	256	263	2.5	1	19.5
	320	130	4	1.5	565	829	—	—	—	1 900	2 300	7330DB	7330DF	7330DT	200.7	70.7	168	—	302	311.5	3	1.5	44.8
	320	130	4	1.5	516	760	—	—	—	1 400	1 900	7330BDB	7330BDF	7330BDT	262.2	132.2	168	—	302	311.5	3	1.5	44.8
	320	130	4	1.5	607	891	—	—	13.7	2 600	3 400	7330CDB	7330CDF	7330CDT	128.0	2.0	168	—	302	311.5	3	1.5	44.8
	160	220	56	2	1	196	289	—	—	16.5	3 500	4 700	7932CDB	7932CDF	7932CDT	78.9	22.9	170	—	210	214.5	2	1
220		56	2	1	81.5	104	—	—	8.8	4 200	6 400	HAR932CDB	HAR932CDF	HAR932CDT	78.9	22.9	170	—	210	214.5	2	1	5.66
240		76	2.1	1.1	127	145	—	—	8.5	4 000	6 100	HAR032CDB	HAR032CDF	HAR032CDT	91.6	15.6	172	—	228	233	2	1	10.8
240		76	2.1	1.1	252	353	—	—	—	2 300	2 800	7032DB	7032DF	7032DT	153.5	77.5	172	—	228	233	2	1	10.9
240		76	2.1	1.1	225	316	—	—	—	1 700	2 300	7032BDB	7032BDF	7032BDT	205.8	129.8	172	—	228	233	2	1	10.9
240		76	2.1	1.1	278	386	—	—	16.0	3 100	4 100	7032CDB	7032CDF	7032CDT	91.6	15.6	172	—	228	233	2	1	10.9
290		96	3	1.1	374	525	—	—	—	2 000	2 500	7232DB	7232DF	7232DT	177.9	81.9	174	—	276	283	2.5	1	24.2
290		96	3	1.1	386	557	—	—	—	1 500	2 000	7232BDB	7232BDF	7232BDT	236.8	140.8	174	—	276	283	2.5	1	24.2
290		96	3	1.1	465	665	—	—	15.2	2 700	3 600	7232CDB	7232CDF	7232CDT	108.3	12.3	174	—	276	283	2.5	1	24.2
340		136	4	1.5	592	909	—	—	—	1 700	2 200	7332DB	7332DF	7332DT	212.3	76.3	178	—	322	331.5	3	1.5	52.8
340		136	4	1.5	540	831	—	—	—	1 300	1 700	7332BDB	7332BDF	7332BDT	277.8	141.8	178	—	322	331.5	3	1.5	52.8
340		136	4	1.5	640	980	—	—	14.0	2 400	3 200	7332CDB	7332CDF	7332CDT	135.0	1.0	168.5	—	322	331.5	3	1.5	52.8
170	230	56	2	1	199	302	—	—	16.6	3 100	4 100	7934CDB	7934CDF	7934CDT	81.6	25.6	180	—	220	224.5	2	1	6.42
	230	56	2	1	83.4	110	—	—	8.8	4 000	6 100	HAR934CDB	HAR934CDF	HAR934CDT	81.6	25.6	180	—	220	224.5	2	1	5.94
	260	84	2.1	1.1	149	173	—	—	8.5	3 700	5 700	HAR034CDB	HAR034CDF	HAR034CDT	99.6	15.6	182	—	248	253	2	1	14.6
	260	84	2.1	1.1	302	429	—	—	—	2 100	2 600	7034DB	7034DF	7034DT	166.2	82.2	182	—	248	253	2	1	15.2

[Notes] 1) Limiting speeds shown above are applicable to machined cage bearings. Limiting speeds of pressed cage bearings should be kept to under 80% of this value. For bearings with 15° contact angle, this figure is applied to the high precision bearings ranked higher than class 5, used with machined cages or molded cages.

2) B, C or no indication after the bearing number indicates nominal contact angle of 40°, 15° and 30° respectively. [Remark] Standard cage types used for the above bearings are described earlier in this section.

Angular contact ball bearings (matched pair)

d (170) ~ 190 mm

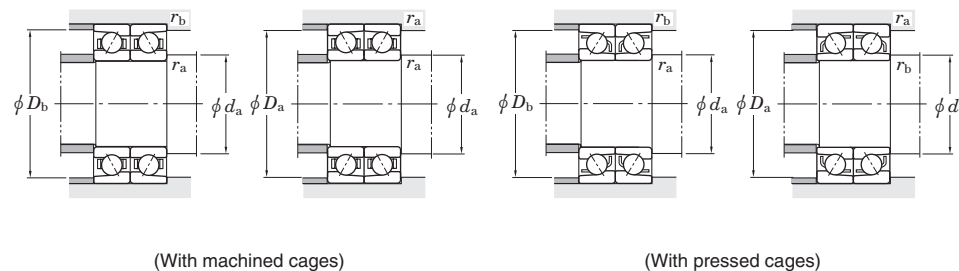
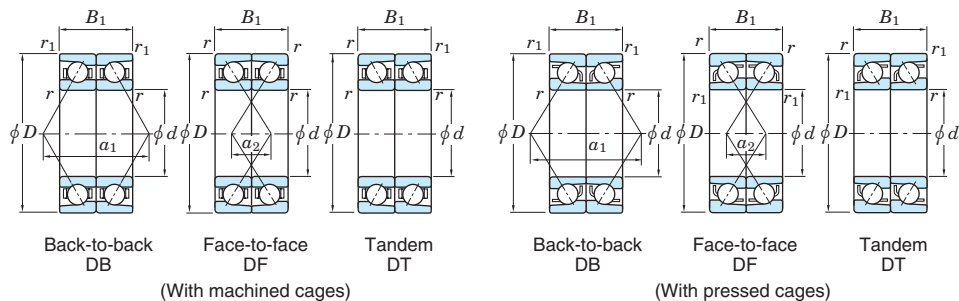

Boundary dimensions (mm)					Basic load ratings (kN)				Factor	Limiting speeds ¹⁾ (min ⁻¹)		Bearing No. ²⁾			Load center spread (mm)		Mounting dimensions (mm)						(Refer.) Mass (kg)
d	D	B ₁	r min.	r ₁ min.	With machined cages		With pressed cages			Grease lub.	Oil lub.	Back-to-back DB	Face-to-face DF	Tandem DT	a ₁	a ₂	d _a min.	d _b min.	D _a max.	D _b max.	r _a max.	r _b max.	
170	260	84	2.1	1.1	270	386	—	—	—	1 600	2 100	7034BDB	7034BDF	7034BDT	222.4	138.4	182	—	248	253	2	1	15.5
	260	84	2.1	1.1	332	469	—	—	15.9	2 900	3 800	7034CDB	7034CDF	7034CDT	99.6	15.6	182	—	248	253	2	1	15.1
	310	104	4	1.5	441	661	—	—	—	1 800	2 300	7234DB	7234DF	7234DT	190.6	86.6	188	—	292	301.5	3	1.5	30.2
	310	104	4	1.5	398	600	—	—	—	1 400	1 800	7234BDB	7234BDF	7234BDT	253.4	149.4	188	—	292	301.5	3	1.5	30.2
	310	104	4	1.5	482	719	—	—	15.1	2 500	3 300	7234CDB	7234CDF	7234CDT	116.3	12.3	188	—	292	301.5	3	1.5	30.2
	360	144	4	1.5	631	969	—	—	—	1 600	2 000	7334DB	7334DF	7334DT	225.0	81.0	188	—	342	351.5	3	1.5	62.4
	360	144	4	1.5	577	888	—	—	—	1 200	1 600	7334BDB	7334BDF	7334BDT	294.4	150.4	188	—	342	351.5	3	1.5	62.4
	360	144	4	1.5	679	1 040	—	—	13.8	2 200	3 000	7334CDB	7334CDF	7334CDT	143.0	1.0	188	—	342	351.5	3	1.5	62.4
180	250	66	2	1	253	375	—	—	16.4	2 800	3 700	7936CDB	7936CDF	7936CDT	90.6	24.6	190	—	240	244.5	2	1	9.36
	280	92	2.1	1.1	344	506	—	—	—	1 900	2 400	7036DB	7036DF	7036DT	178.8	86.8	192	—	268	273	2	1	20.2
	280	92	2.1	1.1	308	457	—	—	—	1 400	1 900	7036BDB	7036BDF	7036BDT	239.0	147.0	192	—	268	273	2	1	20.4
	280	92	2.1	1.1	378	553	—	—	15.7	2 600	3 500	7036CDB	7036CDF	7036CDT	107.6	15.6	192	—	268	273	2	1	19.9
	320	104	4	1.5	477	724	—	—	—	1 700	2 200	7236DB	7236DF	7236DT	196.3	92.3	198	—	302	311.5	3	1.5	31.4
	320	104	4	1.5	430	657	—	—	—	1 300	1 700	7236BDB	7236BDF	7236BDT	261.8	157.8	198	—	302	311.5	3	1.5	31.4
	320	104	4	1.5	520	786	—	—	14.9	2 400	3 200	7236CDB	7236CDF	7236CDT	119.0	15.0	198	—	302	311.5	3	1.5	31.4
	380	150	4	1.5	665	1 070	—	—	—	1 500	1 900	7336DB	7336DF	7336DT	236.7	86.7	198	—	362	371.5	3	1.5	80.0
380	150	4	1.5	606	976	—	—	—	1 100	1 500	7336BDB	7336BDF	7336BDT	309.9	159.9	198	—	362	371.5	3	1.5	80.0	
190	260	66	2	1	257	394	—	—	16.5	2 700	3 600	7938CDB	7938CDF	7938CDT	93.3	27.3	200	—	250	254.5	2	1	9.66
	290	92	2.1	1.1	353	535	—	—	—	1 800	2 300	7038DB	7038DF	7038DT	184.6	92.6	202	—	278	283	2	1	21.6
	290	92	2.1	1.1	316	483	—	—	—	1 400	1 800	7038BDB	7038BDF	7038BDT	247.4	155.4	202	—	278	283	2	1	21.6
	290	92	2.1	1.1	388	585	—	—	15.9	2 500	3 300	7038CDB	7038CDF	7038CDT	110.3	18.3	202	—	278	283	2	1	21.6
	340	110	4	1.5	493	779	—	—	—	1 600	2 000	7238DB	7238DF	7238DT	208.0	98.0	208	—	322	331.5	3	1.5	37.6
	340	110	4	1.5	443	706	—	—	—	1 200	1 600	7238BDB	7238BDF	7238BDT	277.4	167.4	208	—	322	331.5	3	1.5	37.6
	340	110	4	1.5	538	848	—	—	15.1	2 200	3 000	7238CDB	7238CDF	7238CDT	126.0	16.0	208	—	322	331.5	3	1.5	37.6
	400	156	5	2	731	1 200	—	—	—	1 400	1 800	7338DB	7338DF	7338DT	248.3	92.3	212	—	378	390	4	2	91.0
	400	156	5	2	668	1 100	—	—	—	1 100	1 400	7338BDB	7338BDF	7338BDT	325.5	169.5	212	—	378	390	4	2	91.0

[Notes] 1) Limiting speeds shown above are applicable to machined cage bearings. Limiting speeds of pressed cage bearings should be kept to under 80% of this value. For bearings with 15° contact angle, this figure is applied to the high precision bearings ranked higher than class 5, used with machined cages or molded cages.

2) B, C or no indication after the bearing number indicates nominal contact angle of 40°, 15° and 30° respectively. [Remark] Standard cage types used for the above bearings are described earlier in this section.

Angular contact ball bearings (matched pair)

d 200 ~ (340) mm

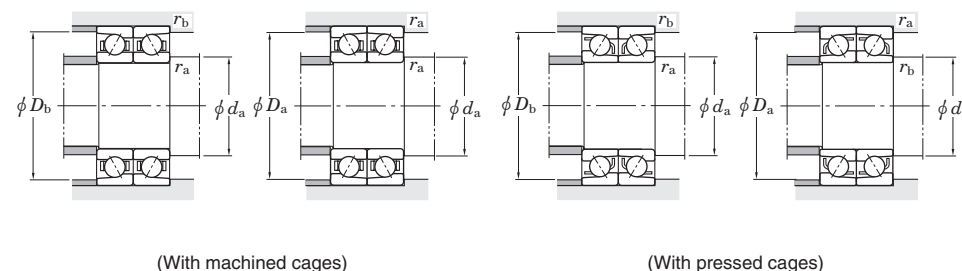
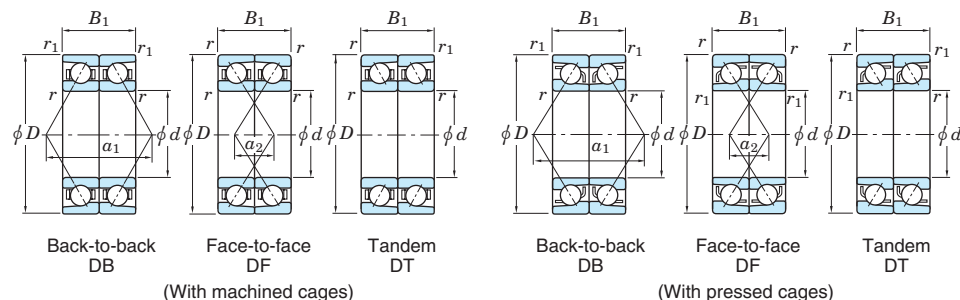

Boundary dimensions (mm)					Basic load ratings (kN)				Factor f_0	Limiting speeds ¹⁾ (min ⁻¹)		Bearing No. ²⁾			Load center spread (mm)		Mounting dimensions (mm)						(Refer.) Mass (kg)
d	D	B_1	r min.	r_1 min.	With machined cages		With pressed cages			Grease lub.	Oil lub.	Back-to-back DB	Face-to-face DF	Tandem DT	a_1	a_2	d_a min.	d_b min.	D_a max.	D_b max.	r_a max.	r_b max.	
200	280	76	2.1	1.1	332	509	—	—	16.3	2 500	3 300	7940CDB	7940CDF	7940CDT	102.3	26.3	212	—	268	273	2	1	13.7
	310	102	2.1	1.1	396	618	—	—	—	1 700	2 100	7040DB	7040DF	7040DT	198.3	96.3	212	—	298	303	2	1	25.4
	310	102	2.1	1.1	355	558	—	—	—	1 300	1 700	7040BDB	7040BDF	7040BDT	265.0	163.0	212	—	298	303	2	1	25.4
	310	102	2.1	1.1	435	676	—	—	15.7	2 300	3 100	7040CDB	7040CDF	7040CDT	119.3	17.3	212	—	298	303	2	1	25.4
	360	116	4	1.5	526	847	—	—	—	1 500	1 900	7240DB	7240DF	7240DT	219.7	103.7	218	—	342	351.5	3	1.5	44.8
	360	116	4	1.5	474	768	—	—	—	1 100	1 500	7240BDB	7240BDF	7240BDT	292.9	176.9	218	—	342	351.5	3	1.5	44.8
	360	116	4	1.5	575	921	—	—	15.1	2 100	2 800	7240CDB	7240CDF	7240CDT	133.0	17.0	218	—	342	351.5	3	1.5	44.8
	420	160	5	2	770	1 320	—	—	—	1 300	1 700	7340DB	7340DF	7340DT	259.0	99.0	222	—	398	410	4	2	104
420	160	5	2	702	1 200	—	—	—	1 000	1 300	7340BDB	7340BDF	7340BDT	340.1	180.1	222	—	398	410	4	2	104	
220	340	112	3	1.1	434	705	—	—	—	1 500	1 900	7044DB	7044DF	—	217.8	105.8	234	—	326	333	2.5	1	37.0
	340	112	3	1.1	389	636	—	—	—	1 100	1 500	7044BDB	7044BDF	—	290.9	178.9	234	—	326	333	2.5	1	37.8
240	360	112	3	1.1	443	751	—	—	—	1 400	1 700	7048DB	7048DF	—	229.2	117.2	254	—	346	353	2.5	1	39.4
	360	112	3	1.1	397	677	—	—	—	1 000	1 400	7048BDB	7048BDF	—	307.7	195.7	254	—	346	353	2.5	1	40.2
	440	144	4	1.5	655	1 190	—	—	—	1 200	1 500	7248DB	7248DF	—	268.3	124.3	258	—	422	431.5	3	1.5	104
	440	144	4	1.5	589	1 080	—	—	—	890	1 200	7248BDB	7248BDF	—	357.3	213.3	258	—	422	431.5	3	1.5	106
260	400	130	4	1.5	529	956	—	—	—	1 200	1 500	7052DB	7052DF	—	256.7	126.7	278	—	382	391.5	3	1.5	57.4
	400	130	4	1.5	473	862	—	—	—	910	1 200	7052BDB	7052BDF	—	341.9	211.9	278	—	382	391.5	3	1.5	58.6
280	420	130	4	1.5	540	1 010	—	—	—	1 100	1 400	7056DB	7056DF	—	267.1	137.1	298	—	402	411.5	3	1.5	60.8
	420	130	4	1.5	483	906	—	—	—	850	1 100	7056BDB	7056BDF	—	358.7	228.7	298	—	402	411.5	3	1.5	62.0
300	460	148	4	1.5	693	1 360	—	—	—	1 000	1 300	7060DB	7060DF	—	293.4	145.4	318	—	442	451.5	3	1.5	87.4
	460	148	4	1.5	621	1 230	—	—	—	770	1 000	7060BDB	7060BDF	—	392.9	244.9	318	—	442	451.5	3	1.5	89.8
320	480	148	4	1.5	710	1 440	—	—	—	950	1 200	7064DB	7064DF	—	304.9	156.9	338	—	462	471.5	3	1.5	92.0
	480	148	4	1.5	636	1 300	—	—	—	710	950	7064BDB	7064BDF	—	409.6	261.6	338	—	462	471.5	3	1.5	94.4
340	520	164	5	2	816	1 720	—	—	—	860	1 100	7068DB	7068DF	—	330.3	166.3	362	—	498	510	4	2	124

[Notes] 1) Limiting speeds shown above are applicable to machined cage bearings. Limiting speeds of pressed cage bearings should be kept to under 80% of this value. For bearings with 15° contact angle, this figure is applied to the high precision bearings ranked higher than class 5, used with machined cages or molded cages.

2) B, C or no indication after the bearing number indicates nominal contact angle of 40°, 15° and 30° respectively. [Remark] Standard cage types used for the above bearings are described earlier in this section.

Angular contact ball bearings (matched pair)

d (340) ~ 380 mm

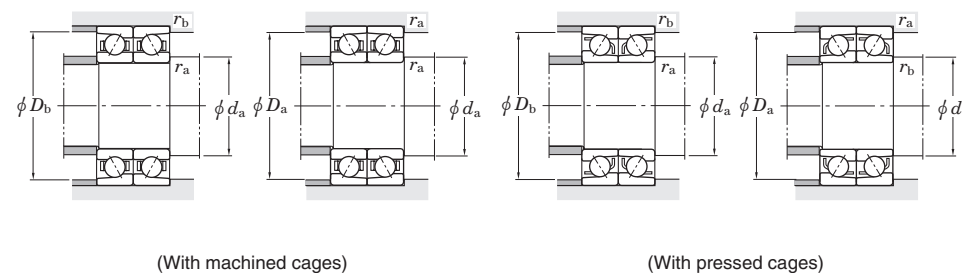
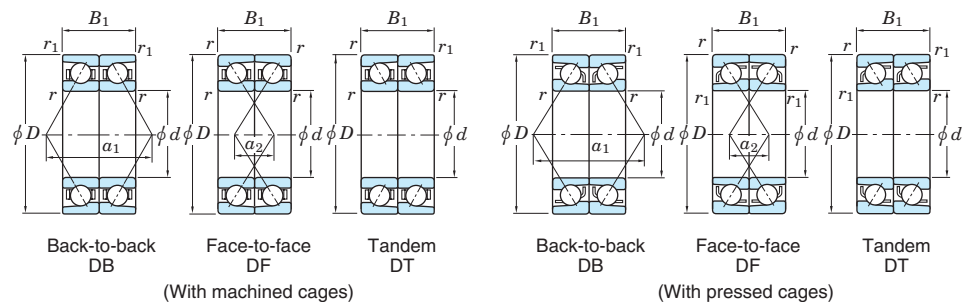

Boundary dimensions (mm)				Basic load ratings (kN)				Factor f_0	Limiting speeds ¹⁾ (min^{-1})		Bearing No. ²⁾			Load center spread (mm)		Mounting dimensions (mm)						(Refer.) Mass (kg)	
d	D	B_1	r min. r_1 min.	With machined cages		With pressed cages			Grease lub.	Oil lub.	Back-to-back DB	Face-to-face DF	Tandem DT	a_1	a_2	d_a min.	d_b min.	D_a max.	D_b max.	r_a max.	r_b max.		
340	520	164	5	2	731	1 550	—	—	—	640	860	7068BDB	7068BDF	—	442.8	278.8	362	—	498	510	4	2	127
	540	164	5	2	837	1 830	—	—	—	800	1 000	7072DB	7072DF	—	341.8	177.8	382	—	518	530	4	2	129
360	540	164	5	2	750	1 650	—	—	—	600	800	7072BDB	7072BDF	—	459.6	295.6	382	—	518	530	4	2	132
	560	164	5	2	858	1 930	—	—	—	750	940	7076DB	7076DF	—	353.4	189.4	402	—	538	550	4	2	134
380	560	164	5	2	767	1 740	—	—	—	560	750	7076BDB	7076BDF	—	476.4	312.4	402	—	538	550	4	2	138

[Notes] 1) Limiting speeds shown above are applicable to machined cage bearings. Limiting speeds of pressed cage bearings should be kept to under 80% of this value. For bearings with 15° contact angle, this figure is applied to the high precision bearings ranked higher than class 5, used with machined cages or molded cages.

2) B or no indication after the bearing number indicates nominal contact angle of 40° and 30° respectively. [Remark] Standard cage types used for the above bearings are described earlier in this section.

Double-row angular contact ball bearings

d 10 ~ (40) mm

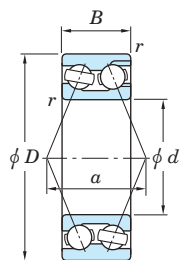

32, 33 series
(With filling slot)

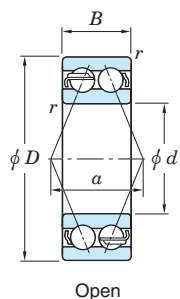

Open

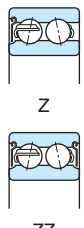

Z



ZZ

Shielded
(Without filling slot)

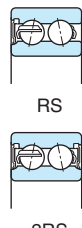

RS



2RS

Contact sealed

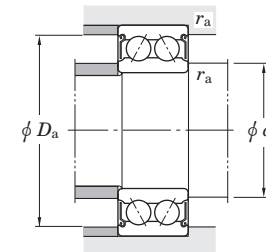
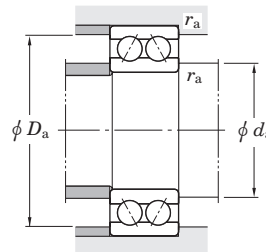

Boundary dimensions (mm)				Basic load ratings (kN)				Limiting speeds (min ⁻¹)			Bearing No.			Load center spread (mm)	Mounting dimensions ¹⁾ (mm)				(Refer.) Mass (kg)	
d	D	B	r _{min.}	Open		Shielded/sealed		Grease lub.		Oil lub.	Sealed		Open		α		da	Da		ra
				C _r	C _{0r}	C _r	C _{0r}	[Open Z, ZZ]	(RS, 2RS)	[Open Z]	Open	Shielded		min.	max.	max.	max.			
10	30	14.3	0.6	7.35	5.35	—	—	15 000	—	20 000	3200	—	—	19.5	14.5	—	25.5	0.6	0.052	
12	32	15.9	0.6	9.70	7.15	—	—	14 000	—	18 000	3201	—	—	21.7	16.5	—	27.5	0.6	0.063	
15	35	15.9	0.6	9.70	7.45	—	—	12 000	—	16 000	3202	—	—	23.6	19.5	—	30.5	0.6	0.072	
	42	19	1	15.2	11.9	—	—	10 000	—	14 000	3302	—	—	27.6	20.5	—	36.5	1	0.132	
17	40	17.5	0.6	13.8	10.8	—	—	11 000	—	14 000	3203	—	—	26.6	21.5	—	35.5	0.6	0.100	
	40	17.5	0.6	13.2	8.15	12.7	8.35	11 000	11 000	14 000	5203	5203 ZZ	5203 2RS	20.0	21.5	23.5	35.5	0.6	0.091	
	47	22.2	1	21.7	17.1	—	—	9 400	—	13 000	3303	—	—	31.0	22.5	—	41.5	1	0.192	
20	47	20.6	1	17.2	15.0	—	—	9 000	—	12 000	3204	—	—	31.5	25.5	—	41.5	1	0.170	
	47	20.6	1	19.7	12.5	16.0	10.8	8 800	8 800	12 000	5204	5204 ZZ	5204 2RS	23.5	25.5	26.6	41.5	1	0.120	
	52	22.2	1.1	20.8	18.4	—	—	8 200	—	11 000	3304	—	—	33.8	27	—	45	1	0.230	
	52	22.2	1.1	24.7	15.0	19.8	12.8	8 300	8 300	11 000	5304	5304 ZZ	5304 2RS	25.9	27	28.3	45	1	0.230	
25	52	20.6	1	18.9	18.2	—	—	7 800	—	10 000	3205	—	—	34.4	30.5	—	46.5	1	0.190	
	52	20.6	1	21.4	14.8	18.9	13.8	7 700	7 700	10 000	5205	5205 ZZ	5205 2RS	26.1	30.5	32.3	46.5	1	0.190	
	62	25.4	1.1	28.9	26.5	—	—	6 800	—	9 100	3305	—	—	40.5	32	—	55	1	0.369	
	62	25.4	1.1	32.7	20.8	27.5	18.5	6 900	6 900	9 200	5305	5305 ZZ	5305 2RS	31.1	32	33.4	55	1	0.340	
30	62	23.8	1	27.3	27.0	—	—	6 500	—	8 700	3206	—	—	40.7	35.5	—	56.5	1	0.320	
	62	23.8	1	29.7	21.3	25.4	18.3	6 400	6 400	8 600	5206	5206 ZZ	5206 2RS	30.8	35.5	38.6	56.5	1	0.290	
	72	30.2	1.1	38.1	36.1	—	—	5 800	—	7 800	3306	—	—	47.2	37	—	65	1	0.585	
	72	30.2	1.1	41.0	28.5	34.3	25.2	5 800	5 800	7 700	5306	5306 ZZ	5306 2RS	36.2	37	41.3	65	1	0.510	
35	72	27	1.1	36.8	37.5	—	—	5 600	—	7 500	3207	—	—	46.9	42	—	65	1	0.480	
	72	27	1.1	39.2	29.0	31.7	24.6	5 500	5 500	7 300	5207	5207 ZZ	5207 2RS	36.1	42	43.9	65	1	0.430	
	80	34.9	1.5	48.6	46.8	—	—	5 200	—	7 000	3307	—	—	53.4	43.5	—	71.5	1.5	0.816	
	80	34.9	1.5	51.2	36.2	46.1	32.8	5 100	5 100	6 800	5307	5307 ZZ	5307 2RS	41.0	43.5	45.5	71.5	1.5	0.790	
40	80	30.2	1.1	42.0	43.9	—	—	5 000	—	6 700	3208	—	—	52.6	47	—	73	1	0.650	

[Note] 1) The maximum value of d_a is applied to shielded and sealed type bearings.

[Remark] Standard cage types used for the above bearings are described earlier in this section.

Double-row angular contact ball bearings

d (40) ~ (70) mm

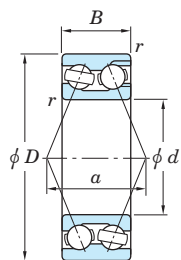

32, 33 series
(With filling slot)

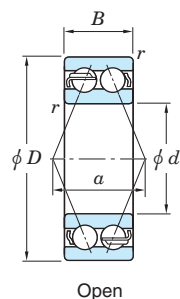

Open



Shielded

52, 53 series
(Without filling slot)



Contact sealed

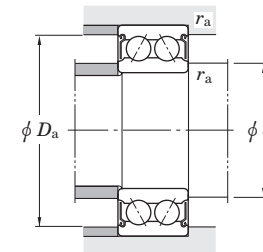
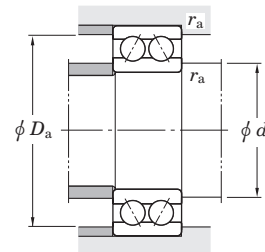

Boundary dimensions (mm)				Basic load ratings (kN)				Limiting speeds (min ⁻¹)			Bearing No.			Load center spread (mm)	Mounting dimensions ¹⁾ (mm)				(Refer.) Mass (kg)
d	D	B	$r_{min.}$	Open		Shielded/sealed		Grease lub.		Oil lub.	Sealed	Open	Shielded	Open α	d_a		D_a max.	r_a max.	Mass
				C_r	C_{0r}	C_r	C_{0r}	[Open Z, ZZ]	(RS, 2RS)	[Open Z]					min.	max.			
40	80	30.2	1.1	44.4	33.6	36.5	29.1	5 000	5 000	6 700	5208	5208 ZZ	5208 2RS	39.2	47	49.5	73	1	0.570
	90	36.5	1.5	54.1	53.8	—	—	4 600	—	6 100	3308	—	—	58.9	48.5	—	81.5	1.5	1.07
	90	36.5	1.5	62.7	45.4	51.4	37.8	4 600	4 600	6 100	5308	5308 ZZ	5308 2RS	44.9	48.5	52.1	81.5	1.5	1.05
45	85	30.2	1.1	45.4	51.4	—	—	4 600	—	6 100	3209	—	—	56.3	52	—	78	1	0.710
	85	30.2	1.1	49.9	38.4	41.7	33.9	4 600	4 600	6 100	5209	5209 ZZ	5209 2RS	42.2	52	55.3	78	1	0.620
	100	39.7	1.5	66.1	67.3	—	—	4 100	—	5 500	3309	—	—	65.6	53.5	—	91.5	1.5	1.42
	100	39.7	1.5	75.1	55.7	68.9	51.4	4 100	4 100	5 500	5309	5309 ZZ	5309 2RS	51.0	53.5	58.2	91.5	1.5	1.42
50	90	30.2	1.1	45.1	52.1	—	—	4 300	—	5 700	3210	—	—	58.8	57	—	83	1	0.760
	90	30.2	1.1	53.3	43.6	44.1	37.9	4 300	4 300	5 600	5210	5210 ZZ	5210 2RS	44.5	57	58.9	83	1	0.670
	110	44.4	2	86.1	88.6	—	—	3 800	—	5 000	3310	—	—	71.7	60	—	100	2	1.95
	110	44.4	2	88.5	67.0	81.8	62.2	3 600	3 600	4 800	5310	5310 ZZ	5310 2RS	56.6	60	64.4	100	2	1.93
55	100	33.3	1.5	50.9	60.2	—	—	3 900	—	5 100	3211	—	—	65.0	63.5	—	91.5	1.5	1.05
	100	33.3	1.5	65.9	55.2	52.9	44.7	3 800	3 800	5 100	5211	5211 ZZ	5211 2RS	50.2	63.5	66.2	91.5	1.5	0.960
	120	49.2	2	101	106	—	—	3 400	—	4 500	3311	—	—	79.3	65	—	110	2	2.53
	120	49.2	2	110	85.1	95.7	74.3	3 300	3 300	4 500	5311	5311 ZZ	5311 2RS	61.6	65	71.8	110	2	2.30
60	110	36.5	1.5	64.0	76.8	—	—	3 500	—	4 700	3212	—	—	71.3	68.5	—	101.5	1.5	1.40
	110	36.5	1.5	74.4	60.8	62.6	55.9	3 500	3 500	4 700	5212	5212 ZZ	5212 2RS	53.8	68.5	74.1	101.5	1.5	1.36
	130	54	2.1	125	132	—	—	3 100	—	4 200	3312	—	—	87.4	72	—	118	2	3.24
	130	54	2.1	126	98.7	110	87.1	3 100	3 100	4 100	5312	5312 ZZ	5312 2RS	67.2	72	79.2	118	2	3.16
65	120	38.1	1.5	76.4	97.4	—	—	3 200	—	4 300	3213	—	—	76.8	73.5	—	111.5	1.5	1.75
	120	38.1	1.5	86.9	75.3	69.2	63.1	3 200	3 200	4 300	5213	5213 ZZ	5213 2RS	58.8	73.5	79.0	111.5	1.5	1.66
	140	58.7	2.1	142	153	—	—	2 900	—	3 900	3313	—	—	92.7	77	—	128	2	4.08
	140	58.7	2.1	142	113	142	113	2 900	2 900	3 900	5313	5313 ZZ	5313 2RS	70.9	77	85.9	128	2	3.91
70	125	39.7	1.5	77.9	96.4	—	—	3 100	—	4 100	3214	—	—	80.7	78.5	—	116.5	1.5	1.92
	125	39.7	1.5	94.5	82.6	76.3	70.3	3 100	3 100	4 100	5214	5214 ZZ	5214 2RS	61.4	78.5	83.5	116.5	1.5	1.81
	150	63.5	2.1	151	160	—	—	2 700	—	3 600	3314	—	—	99.7	82	—	138	2	5.04

[Note] 1) The maximum value of d_a is applied to shielded and sealed type bearings.

[Remark] Standard cage types used for the above bearings are described earlier in this section.

Double-row angular contact ball bearings

d (70) ~ 110 mm

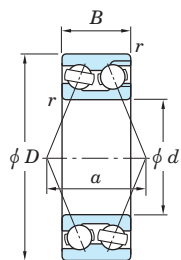

32, 33 series
(With filling slot)

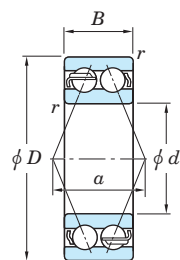

Open

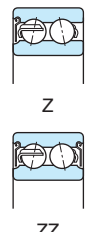

Z

ZZ

Shielded

52, 53 series
(Without filling slot)

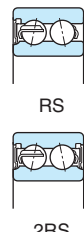

RS

2RS

Contact sealed

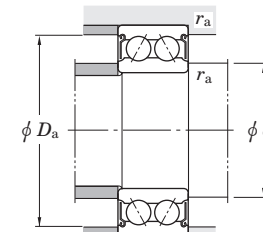
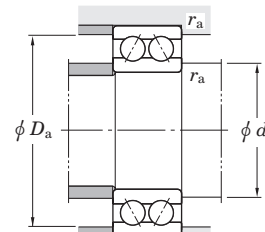

Boundary dimensions (mm)				Basic load ratings (kN)				Limiting speeds (min ⁻¹)			Bearing No.			Load center spread (mm)	Mounting dimensions ¹⁾ (mm)				(Refer.) Mass (kg)
d	D	B	$r_{min.}$	Open		Shielded/sealed		Grease lub.		Oil lub.	Open	Shielded	Sealed		d_a		D_a	r_a	
				C_r	C_{0r}	C_r	C_{0r}	[Open Z, ZZ]	(RS, 2RS)	[Open Z]	Open	Shielded		Open α	min.	max.	max.	max.	
70	150	63.5	2.1	160	129	160	129	2 700	2 700	3 600	5314	5314 ZZ	5314 2RS	76.0	82	92.9	138	2	4.89
75	130	41.3	1.5	92.4	120	—	—	2 900	—	3 900	3215	—	—	84.7	83.5	—	121.5	1.5	2.10
	160	68.3	2.1	169	189	—	—	2 500	—	3 300	3315	—	—	108.7	87	—	148	2	6.16
	160	68.3	2.1	174	147	174	147	2 500	2 500	3 300	5315	5315 ZZ	5315 2RS	81.5	87	99.6	148	2	5.97
80	140	44.4	2	97.5	121	—	—	2 700	—	3 600	3216	—	—	90.7	90	—	130	2	2.64
	170	68.3	2.1	184	213	—	—	2 400	—	3 100	3316	—	—	113.1	92	—	158	2	6.93
85	150	49.2	2	114	143	—	—	2 500	—	3 400	3217	—	—	98.4	95	—	140	2	3.39
	180	73	3	188	219	—	—	2 200	—	3 000	3317	—	—	118.8	99	—	166	2.5	8.30
90	160	52.4	2	132	167	—	—	2 400	—	3 100	3218	—	—	104.1	100	—	150	2	4.14
	190	73	3	205	242	—	—	2 100	—	2 800	3318	—	—	125.5	104	—	176	2.5	9.23
95	170	55.6	2.1	152	193	—	—	2 200	—	3 000	3219	—	—	110.6	107	—	158	2	5.00
	200	77.8	3	218	270	—	—	2 000	—	2 600	3319	—	—	132.2	109	—	186	2.5	10.9
100	180	60.3	2.1	172	221	—	—	2 100	—	2 800	3220	—	—	116.8	112	—	168	2	6.10
	215	82.6	3	249	324	—	—	1 800	—	2 500	3320	—	—	140.4	114	—	201	2.5	13.5
105	190	65.1	2.1	182	237	—	—	2 000	—	2 600	3221	—	—	124.2	117	—	178	2	7.37
	225	87.3	3	265	354	—	—	1 800	—	2 300	3321	—	—	148.1	119	—	211	2.5	15.6
110	200	69.8	2.1	201	263	—	—	1 900	—	2 500	3222	—	—	131.4	122	—	188	2	8.80
	240	92.1	3	281	388	—	—	1 600	—	2 200	3322	—	—	156.4	124	—	226	2.5	18.9

[Note] 1) The maximum value of d_a is applied to shielded and sealed type bearings.

[Remark] Standard cage types used for the above bearings are described earlier in this section.

Four-point contact ball bearings

d 20 ~ 75 mm

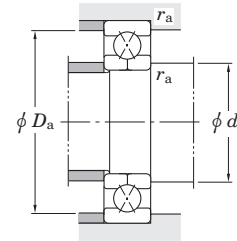
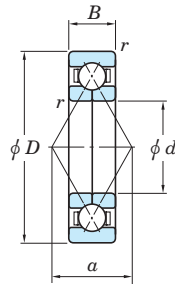

Boundary dimensions (mm)				Basic load ratings (kN)		Limiting speeds (min ⁻¹)		Bearing No.	Load center spread (mm) a	Mounting dimensions (mm)			(Refer.) Mass (kg)
d	D	B	$r_{min.}$	C_r	C_{0r}	Grease lub.	Oil lub.			d_a min.	D_a max.	r_a max.	
20	47	14	1	23.5	15.3	12 000	16 000	6204BI 6304BI	23.5	25.5	41.5	1	0.129
	52	15	1.1	27.4	18.1	11 000	15 000			27.0	45	1	
25	52	15	1	26.7	18.8	10 000	14 000	6205BI 6305BI	27.0	30.5	46.5	1	0.156
	62	17	1.1	40.8	28.0	9 200	13 000			32	55	1	
30	62	16	1	36.3	27.6	8 600	12 000	6206BI 6306BI	32.6	35.5	56.5	1	0.241
	72	19	1.1	49.5	36.6	7 800	11 000			37	65	1	
35	72	17	1.1	47.1	36.7	7 500	10 000	6207BI 6307BI	37.5	42	65	1	0.351
	80	21	1.5	61.2	46.4	7 000	9 600			43.5	71.5	1.5	
40	80	18	1.1	55.9	46.5	6 600	9 000	6208BI 6308BI	42.7	47	73	1	0.451
	90	23	1.5	74.1	57.6	6 200	8 500			48.5	81.5	1.5	
45	85	19	1.1	58.7	51.3	6 100	8 400	6209BI 6309BI	45.9	52	78	1	0.512
	100	25	1.5	87.9	70.0	5 500	7 600			53.5	91.5	1.5	
50	90	20	1.1	65.4	58.0	5 700	7 900	6210BI 6310BI	49.0	57	83	1	0.575
	110	27	2	103	83.7	5 000	6 900			60	100	2	
55	100	21	1.5	80.0	72.3	5 200	7 100	6211BI 6311BI	54.3	63.5	91.5	1.5	0.763
	120	29	2	119	98.5	4 500	6 200			65	110	2	
60	110	22	1.5	91.7	87.6	4 600	6 300	6212BI 6312BI	60.6	68.5	101.5	1.5	0.983
	130	31	2.1	145	126	4 100	5 700			72	118	2	
65	120	23	1.5	95.1	90.1	4 300	5 900	6213BI 6313BI	64.8	73.5	111.5	1.5	1.23
	140	33	2.1	164	145	3 800	5 300			77	128	2	
70	125	24	1.5	103	99.0	4 100	5 600	6214BI 6314BI	68.3	78.5	116.5	1.5	1.35
	150	35	2.1	184	165	3 600	4 900			82	138	2	
75	130	25	1.5	108	108	3 900	5 300	6215BI 6315BI	71.8	83.5	121.5	1.5	1.47
	160	37	2.1	200	187	3 400	4 600			87	148	2	

Four-point contact ball bearings

d 80 ~ 110 mm

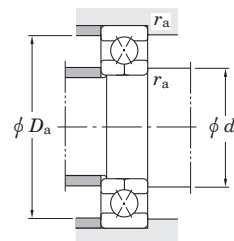
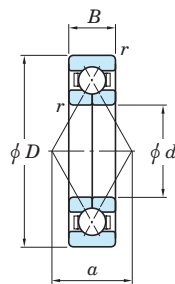

Boundary dimensions (mm)				Basic load ratings (kN)		Limiting speeds (min ⁻¹)		Bearing No.	Load center spread (mm) a	Mounting dimensions (mm)			(Refer.) Mass (kg)
d	D	B	$r_{min.}$	C_r	C_{0r}	Grease lub.	Oil lub.			d_a min.	D_a max.	r_a max.	
80	140	26	2	126	128	3 600	4 900	6216BI	77.0	90	130	2	1.80
	170	39	2.1	217	210	3 100	4 300	6316BI	87.5	92	158	2	4.63
85	150	28	2	146	150	3 400	4 600	6217BI	82.3	95	140	2	2.25
	180	41	3	234	234	3 000	4 100	6317BI	92.8	99	166	2.5	5.45
90	160	30	2	167	173	3 100	4 300	6218BI	87.5	100	150	2	2.77
	190	43	3	252	260	2 800	3 800	6318BI	98.0	104	176	2.5	6.36
95	170	32	2.1	190	198	3 000	4 100	6219BI	92.8	107	158	2	3.37
	200	45	3	269	287	2 600	3 600	6319BI	103.3	109	186	2.5	7.37
100	180	34	2.1	201	213	2 800	3 800	6220BI	98.0	112	168	2	4.02
110	200	38	2.1	242	275	2 500	3 400	6222BI	108.5	122	188	2	5.64

Self-aligning ball bearings

Self-aligning ball bearings have a spherical outer ring raceway, the center of whose curvature meets that of the bearing itself, so that the inner ring, balls and cage continue to rotate, aligning themselves if they have become misaligned within design limits.

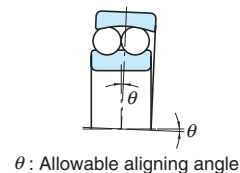

This type of bearing is suitable when the displacement of the centers around which the shaft and housing rotate and shaft deflection are likely to occur.

Bearings with a tapered bore can easily be fit to the shaft with an adapter assembly.



Self-aligning ball bearings



Cylindrical bore Tapered bore

Bore diameter 5 – 110 mm



Sealed type

Bore diameter 10 – 110 mm

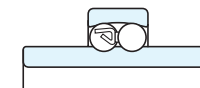

Extended inner ring type

Bore diameter 20 – 60 mm

Adapter assemblies



Bore diameter 17 – 100 mm

Boundary dimensions	The dimensions of standard series are as specified in JIS B 1512.
Tolerances	As specified in JIS B 1514-1, class 0. (refer to Table 7-3 on pp. A 54 – A 57.)
Radial internal clearance	As specified in JIS B 1520. (refer to Table 10-6 on p. A 99.)
Recommended fits	Refer to Table 9-4 on pp. A 85, 86.
Standard cages	<ul style="list-style-type: none"> Staggered type pressed steel cage (application : all dimensional range of 12, 13, 112, 113, 22...2RS and 23...2RS series) Snap type pressed steel cage (application : all dimensional range of 22 series and those of No. 2300 thru 2316.) Copper alloy machined cage (application : bearings of No. 2317 thru 2322)
Allowable aligning angle	<ul style="list-style-type: none"> 12 and 22 series 0.044 rad (2.5°) 13 and 23 series 0.052 rad (3°) 22...2RS and 23...2RS series 0.026 rad (1.5°)

Dynamic equivalent radial load

$$P_r = X F_r + Y F_a$$

$F_a / F_r \leq e$		$F_a / F_r > e$	
X	Y	X	Y
1	Y_1	0.65	Y_2

Static equivalent radial load

$$P_{0r} = F_r + Y_0 F_a$$

Refer to the bearing specification table for values of e , Y_1 , Y_2 and Y_0 .

Self-aligning ball bearings
open type

d 5 ~ (20) mm

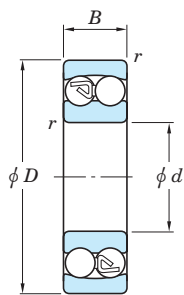

Cylindrical bore

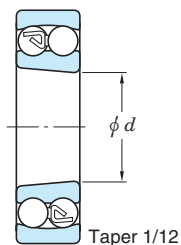

Tapered bore

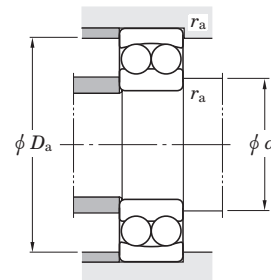

Boundary dimensions (mm)				Basic load ratings (kN)		Limiting speeds (min ⁻¹)		Bearing No.		Mounting dimensions (mm)			Con-stant e	Axial load factors			(Refer.) Mass (kg)	
d	D	B	$r_{min.}$	C_r	C_{0r}	Grease lub.	Oil lub.	Cylindrical bore	Tapered bore	d_a min.	D_a max.	r_a max.		Y_1	Y_2	Y_0	Cylindrical bore	Tapered bore
5	19	6	0.3	2.55	0.48	30 000	37 000	135	—	7	17	0.3	0.34	1.86	2.87	1.94	0.009	—
6	19	6	0.3	2.50	0.48	30 000	37 000	126	—	8	17	0.3	0.34	1.86	2.87	1.94	0.009	—
7	22	7	0.3	2.65	0.56	27 000	33 000	127	—	9	20	0.3	0.35	1.82	2.82	1.91	0.014	—
8	22	7	0.3	2.60	0.56	26 000	33 000	108	—	10	20	0.3	0.35	1.82	2.82	1.91	0.014	—
9	26	8	0.6	3.80	0.80	23 000	29 000	129	—	13	22	0.6	0.34	1.86	2.87	1.94	0.022	—
10	30	9	0.6	5.50	1.20	23 000	28 000	1200	—	14	26	0.6	0.33	1.92	2.97	2.01	0.034	—
	30	14	0.6	7.40	1.60	23 000	29 000	2200	—	14	26	0.6	0.59	1.07	1.65	1.12	0.047	—
	35	11	0.6	7.25	1.60	20 000	24 000	1300	—	14	31	0.6	0.34	1.85	2.87	1.94	0.058	—
	35	17	0.6	9.30	2.10	18 000	24 000	2300	—	14	31	0.6	0.59	1.07	1.66	1.13	0.085	—
12	32	10	0.6	5.60	1.25	21 000	26 000	1201	—	16	28	0.6	0.33	1.89	2.93	1.98	0.040	—
	32	14	0.6	7.65	1.75	21 000	26 000	2201	—	16	28	0.6	0.53	1.18	1.83	1.24	0.053	—
	37	12	1	9.40	2.15	18 000	22 000	1301	—	17	32	1	0.36	1.77	2.74	1.86	0.067	—
	37	17	1	9.70	2.30	16 000	22 000	2301	—	17	32	1	0.54	1.17	1.81	1.23	0.095	—
15	35	11	0.6	7.45	1.75	18 000	22 000	1202	—	19	31	0.6	0.33	1.90	2.95	2.00	0.049	—
	35	14	0.6	7.70	1.85	18 000	22 000	2202	—	19	31	0.6	0.50	1.27	1.97	1.33	0.060	—
	42	13	1	9.55	2.30	16 000	20 000	1302	—	20	37	1	0.34	1.86	2.88	1.95	0.094	—
	42	17	1	12.1	2.90	14 000	20 000	2302	—	20	37	1	0.50	1.27	1.96	1.33	0.114	—
17	40	12	0.6	7.90	2.00	16 000	20 000	1203	—	21	36	0.6	0.31	2.03	3.14	2.12	0.073	—
	40	16	0.6	9.80	2.40	16 000	20 000	2203	—	21	36	0.6	0.50	1.27	1.96	1.33	0.088	—
	47	14	1	12.5	3.20	14 000	17 000	1303	—	22	42	1	0.33	1.92	2.97	2.01	0.130	—
	47	19	1	14.5	3.60	13 000	18 000	2303	—	22	42	1	0.49	1.28	1.98	1.34	0.158	—
20	47	14	1	9.90	2.60	14 000	17 000	1204	1204K	25	42	1	0.29	2.16	3.35	2.27	0.120	0.118
	47	18	1	12.6	3.30	14 000	17 000	2204	2204K	25	42	1	0.48	1.31	2.02	1.37	0.140	0.136
	52	15	1.1	12.4	3.30	13 000	15 000	1304	1304K	26.5	45.5	1	0.30	2.12	3.28	2.22	0.163	0.161

[Remark] Standard cage types used for the above bearings are described earlier in this section.

Self-aligning ball bearings
open type

d (20) ~ 50 mm

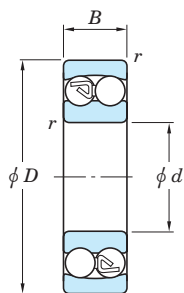

Cylindrical bore

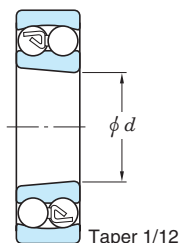

Tapered bore

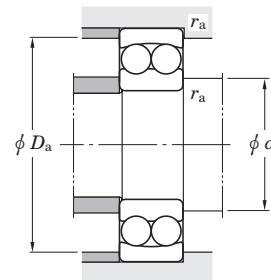

Boundary dimensions (mm)				Basic load ratings (kN)		Limiting speeds (min ⁻¹)		Bearing No.		Mounting dimensions (mm)			Con-stant e	Axial load factors			(Refer.) Mass (kg)	
d	D	B	$r_{min.}$	C_r	C_{0r}	Grease lub.	Oil lub.	Cylindrical bore	Tapered bore	d_a min.	D_a max.	r_a max.		Y_1	Y_2	Y_0	Cylindrical bore	Tapered bore
20	52	21	1.1	18.0	4.70	11 000	15 000	2304	2304K	26.5	45.5	1	0.49	1.29	2.00	1.35	0.209	0.205
25	52	15	1	12.1	3.30	12 000	14 000	1205	1205K	30	47	1	0.28	2.28	3.52	2.39	0.141	0.138
	52	18	1	12.6	3.50	12 000	15 000	2205	2205K	30	47	1	0.40	1.58	2.45	1.66	0.163	0.158
	62	17	1.1	18.0	5.00	9 900	12 000	1305	1305K	31.5	55.5	1	0.27	2.31	3.57	2.42	0.257	0.252
	62	24	1.1	24.4	6.60	9 400	13 000	2305	2305K	31.5	55.5	1	0.46	1.36	2.10	1.42	0.335	0.327
30	62	16	1	15.6	4.65	9 900	12 000	1206	1206K	35	57	1	0.25	2.55	3.94	2.67	0.220	0.216
	62	20	1	15.6	4.65	10 000	12 000	2206	2206K	35	57	1	0.35	1.79	2.77	1.87	0.260	0.254
	72	19	1.1	21.3	6.30	8 700	11 000	1306	1306K	36.5	65.5	1	0.26	2.40	3.72	2.52	0.387	0.381
	72	27	1.1	31.4	8.75	8 000	11 000	2306	2306K	36.5	65.5	1	0.44	1.44	2.23	1.51	0.500	0.489
35	72	17	1.1	15.8	5.10	8 500	10 000	1207	1207K	41.5	65.5	1	0.23	2.71	4.20	2.84	0.323	0.317
	72	23	1.1	21.6	6.60	8 500	10 000	2207	2207K	41.5	65.5	1	0.37	1.71	2.65	1.79	0.403	0.396
	80	21	1.5	25.1	7.85	7 600	9 300	1307	1307K	43	72	1.5	0.25	2.48	3.84	2.60	0.510	0.502
	80	31	1.5	39.4	11.3	7 100	9 800	2307	2307K	43	72	1.5	0.45	1.39	2.15	1.46	0.675	0.657
40	80	18	1.1	19.2	6.50	7 500	9 200	1208	1208K	46.5	73.5	1	0.22	2.83	4.38	2.97	0.417	0.411
	80	23	1.1	22.4	7.40	7 600	9 300	2208	2208K	46.5	73.5	1	0.33	1.92	2.96	2.01	0.505	0.494
	90	23	1.5	29.5	9.70	6 900	8 400	1308	1308K	48	82	1.5	0.25	2.57	3.98	2.69	0.715	0.704
	90	33	1.5	44.9	13.5	6 200	8 600	2308	2308K	48	82	1.5	0.43	1.47	2.27	1.54	0.925	0.903
45	85	19	1.1	21.8	7.35	7 000	8 500	1209	1209K	51.5	78.5	1	0.21	2.94	4.56	3.09	0.465	0.459
	85	23	1.1	23.3	8.15	7 000	8 500	2209	2209K	51.5	78.5	1	0.30	2.09	3.23	2.19	0.545	0.533
	100	25	1.5	38.1	12.7	6 100	7 500	1309	1309K	53	92	1.5	0.25	2.56	3.95	2.68	0.957	0.942
	100	36	1.5	54.4	16.7	5 600	7 700	2309	2309K	53	92	1.5	0.42	1.51	2.33	1.58	1.23	1.20
50	90	20	1.1	22.7	8.10	6 500	7 900	1210	1210K	56.5	83.5	1	0.21	3.07	4.76	3.22	0.525	0.515
	90	23	1.1	23.3	8.50	6 500	7 900	2210	2210K	56.5	83.5	1	0.27	2.33	3.61	2.45	0.590	0.577
	110	27	2	43.4	14.1	5 600	6 800	1310	1310K	59	101	2	0.23	2.70	4.17	2.83	1.21	1.19
	110	40	2	64.6	20.3	5 100	7 000	2310	2310K	59	101	2	0.40	1.56	2.41	1.63	1.64	1.60

[Remark] Standard cage types used for the above bearings are described earlier in this section.

Self-aligning ball bearings
open type

d 55 ~ (85) mm

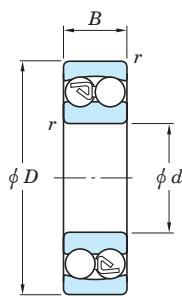

Cylindrical bore

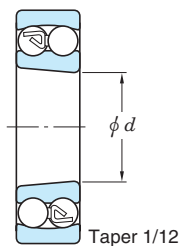

Tapered bore

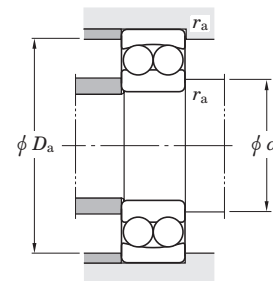

[Note] Protruding distance of balls

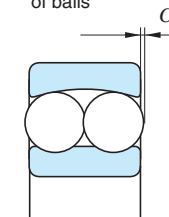

Balls of the following bearing protrude by C₁ from the bearing side.

Boundary dimensions (mm)				Basic load ratings (kN)		Limiting speeds (min ⁻¹)		Bearing No.		Mounting dimensions (mm)			Con-stant e	Axial load factors			(Refer.) Mass (kg)	
d	D	B	r min.	C _r	C _{0r}	Grease lub.	Oil lub.	Cylindrical bore	Tapered bore	d _a min.	D _a max.	r _a max.		Y ₁	Y ₂	Y ₀	Cylindrical bore	Tapered bore
55	100	21	1.5	26.8	10.0	5 800	7 100	1211	1211K	63	92	1.5	0.20	3.19	4.94	3.34	0.705	0.693
	100	25	1.5	26.8	10.0	5 800	7 100	2211	2211K	63	92	1.5	0.27	2.35	3.64	2.47	0.810	0.792
	120	29	2	51.3	17.9	5 000	6 200	1311	1311K	64	111	2	0.23	2.70	4.18	2.83	1.58	1.56
	120	43	2	75.3	24.0	4 600	6 400	2311	2311K	64	111	2	0.41	1.53	2.37	1.60	2.10	2.05
60	110	22	1.5	30.2	11.5	5 200	6 400	1212	1212K	68	102	1.5	0.19	3.37	5.22	3.53	0.900	0.885
	110	28	1.5	34.1	12.6	5 300	6 500	2212	2212K	68	102	1.5	0.28	2.26	3.49	2.36	1.09	1.07
	130	31	2.1	57.2	20.8	4 500	5 500	1312	1312K	71	119	2	0.22	2.91	4.50	3.05	1.96	1.93
	130	46	2.1	87.2	28.3	4 200	5 800	2312	2312K	71	119	2	0.39	1.62	2.51	1.70	2.60	2.53
65	120	23	1.5	31.0	12.5	4 800	5 800	1213	1213K	73	112	1.5	0.17	3.67	5.68	3.84	1.15	1.13
	120	31	1.5	43.5	16.4	4 900	5 900	2213	2213K	73	112	1.5	0.28	2.24	3.47	2.35	1.46	1.43
	140	33	2.1	61.7	22.9	4 300	5 200	1313	1313K	76	129	2	0.23	2.73	4.23	2.86	2.45	2.41
	140	48	2.1	95.8	32.5	3 800	5 300	2313	2313K	76	129	2	0.38	1.66	2.58	1.74	3.23	3.15
70	125	24	1.5	34.6	13.8	4 600	5 700	1214	—	78	117	1.5	0.18	3.48	5.38	3.64	1.26	—
	125	31	1.5	43.9	17.1	4 600	5 600	2214	—	78	117	1.5	0.26	2.42	3.74	2.53	1.52	—
	150	35	2.1	74.0	27.7	4 000	4 900	1314	—	81	139	2	0.22	2.84	4.40	2.98	2.99	—
	150	51	2.1	89.6	31.7	3 600	4 900	2314	—	81	139	2	0.35	1.82	2.82	1.91	4.23	—
75	130	25	1.5	38.8	15.7	4 300	5 300	1215	1215K	83	122	1.5	0.17	3.60	5.58	3.77	1.36	1.34
	130	31	1.5	44.2	17.8	4 300	5 300	2215	2215K	83	122	1.5	0.25	2.49	3.85	2.61	1.62	1.58
	160	37	2.1	78.9	29.9	4 000	4 900	1315	1315K	86	149	2	0.23	2.80	4.33	2.93	3.56	3.51
	160	55	2.1	103	36.8	3 400	4 600	2315	2315K	86	149	2	0.34	1.86	2.88	1.95	5.13	5.01
80	140	26	2	39.8	17.0	4 000	4 900	1216	1216K	89	131	2	0.16	3.90	6.03	4.08	1.67	1.64
	140	33	2	49.0	19.9	4 100	5 000	2216	2216K	89	131	2	0.26	2.42	3.75	2.54	2.01	1.97
	170	39	2.1	88.1	33.1	3 500	4 300	1316	1316K	91	159	2	0.22	2.90	4.49	3.04	4.18	4.12
	170	58	2.1	129	45.7	3 100	4 300	2316	2316K	91	159	2	0.34	1.87	2.90	1.96	6.10	5.96
85	150	28	2	49.2	20.8	3 800	4 600	1217	1217K	94	141	2	0.17	3.61	5.59	3.78	2.07	2.04

[Remark] Standard cage types used for the above bearings are described earlier in this section.

Self-aligning ball bearings
open type

d (85) ~ 110 mm

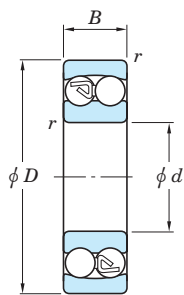

Cylindrical bore

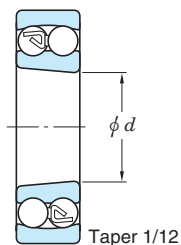

Tapered bore

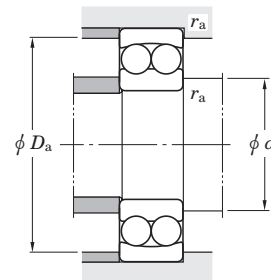

[Note] Protruding distance of balls

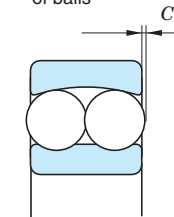

Balls of the following bearing protrude by C_1 from the bearing side.

Boundary dimensions (mm)				Basic load ratings (kN)		Limiting speeds (min ⁻¹)		Bearing No.		Mounting dimensions (mm)			Constant e	Axial load factors			(Refer.) Mass (kg)	
d	D	B	$r_{min.}$	C_r	C_{0r}	Grease lub.	Oil lub.	Cylindrical bore	Tapered bore	d_a min.	D_a max.	r_a max.		Y_1	Y_2	Y_0	Cylindrical bore	Tapered bore
85	150	36	2	58.3	23.6	3 800	4 600	2217	2217K	94	141	2	0.25	2.49	3.85	2.61	2.52	2.46
	180	41	3	97.3	37.8	3 300	4 000	1317	1317K	98	167	2.5	0.22	2.93	4.53	3.07	4.98	4.91
	180	60	3	141	51.5	3 000	4 100	2317	2317K	98	167	2.5	0.35	1.82	2.82	1.91	7.05	6.89
90	160	30	2	56.8	23.4	3 500	4 300	1218	1218K	99	151	2	0.17	3.69	5.70	3.86	2.52	2.48
	160	40	2	67.7	27.2	3 500	4 300	2218	2218K	99	151	2	0.26	2.39	3.71	2.51	3.40	3.33
	190	43	3	116	44.4	3 100	3 800	1318	1318K	103	177	2.5	0.22	2.81	4.35	2.94	5.80	5.71
	190	64	3	153	57.9	2 800	3 900	2318	2318K	103	177	2.5	0.34	1.84	2.85	1.93	8.44	8.25
95	170	32	2.1	57.0	24.3	3 300	4 000	1219	1219K	106	159	2	0.17	3.63	5.62	3.80	3.10	3.05
	170	43	2.1	82.7	34.3	3 300	4 000	2219	2219K	106	159	2	0.26	2.43	3.76	2.55	4.10	4.00
	200	45	3	132	50.8	2 900	3 600	1319	1319K	108	187	2.5	0.23	2.73	4.23	2.86	6.69	6.59
	200	67	3	166	64.8	2 700	3 700	2319	2319K	108	187	2.5	0.35	1.82	2.82	1.91	9.79	9.57
100	180	34	2.1	69.0	29.7	3 100	3 800	1220	1220K	111	169	2	0.17	3.62	5.60	3.79	3.70	3.64
	180	46	2.1	80.9	34.0	3 100	3 800	2220	2220K	111	169	2	0.24	2.57	3.98	2.70	4.98	4.87
	215	47	3	143	57.3	2 800	3 400	1320	1320K	113	202	2.5	0.24	2.66	4.11	2.78	8.30	8.19
	215	73	3	183	73.4	2 400	3 400	2320	2320K	113	202	2.5	0.34	1.84	2.85	1.93	12.4	12.1
105	190	36	2.1	77.0	34.0	2 900	3 600	1221	—	116	179	2	0.18	3.56	5.51	3.73	4.37	—
	190	50	2.1	94.9	40.1	3 000	3 600	2221	—	116	179	2	0.26	2.43	3.76	2.55	6.07	—
	225	49	3	149	60.2	2 600	3 200	1321	—	118	212	2.5	0.23	2.73	4.22	2.86	10.0	—
	225	77	3	187	78.0	2 300	3 200	2321	—	118	212	2.5	0.36	1.75	2.71	1.83	14.3	—
110	200	38	2.1	80.2	35.2	2 800	3 400	1222	1222K	121	189	2	0.17	3.64	5.63	3.81	5.15	5.07
	200	53	2.1	120	48.9	2 800	3 400	2222	2222K	121	189	2	0.26	2.41	3.73	2.53	7.10	6.94
	240	50	3	150	63.2	2 400	3 000	1322	1322K	123	227	2.5	0.22	2.82	4.37	2.96	11.8	11.7
	240	80	3	200	85.7	2 200	3 000	2322	2322K	123	227	2.5	0.35	1.82	2.82	1.91	17.3	16.9

Bearing No.	C_1 (mm)
1319	1.6
1320	2.5
1321	2.5
1322	2.6

(approx.)

[Remark] Standard cage types used for the above bearings are described earlier in this section.

Self-aligning ball bearings
sealed type

d 10 ~ 55 mm

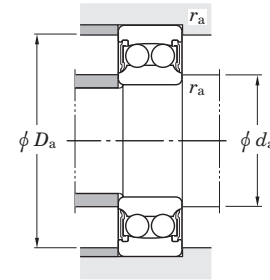
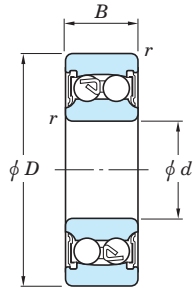

Boundary dimensions (mm)				Basic load ratings (kN)		Limiting speed (min ⁻¹)	Bearing No.	Mounting dimensions (mm)				Constant e	Axial load factors			(Refer.) Mass (kg)
d	D	B	$r_{min.}$	C_r	C_{Or}	Grease lub.		d_a min.	d_a max.	D_a max.	r_a max.		Y_1	Y_2	Y_0	
10	30	14	0.6	5.40	1.20	15 000	2200 2RS 2300 2RS	13.7	13.7	25	0.6	0.33	1.92	2.97	2.01	0.047
	35	17	0.6	7.25	1.60	13 000		15	15.7	30	0.6	0.34	1.85	2.87	1.94	0.085
12	32	14	0.6	5.60	1.25	14 000	2201 2RS 2301 2RS	15.2	15.2	27	0.6	0.33	1.89	2.93	1.98	0.053
	37	17	1	9.40	2.15	12 000		16.8	16.8	31	1	0.36	1.77	2.74	1.86	0.095
15	35	14	0.6	7.45	1.75	12 000	2202 2RS 2302 2RS	18.0	18.0	30	0.6	0.33	1.90	2.95	2.00	0.060
	42	17	1	9.55	2.30	11 000		20.0	20.0	36	1	0.34	1.86	2.88	1.95	0.114
17	40	16	0.6	7.90	2.00	11 000	2203 2RS 2303 2RS	20.2	20.2	35	0.6	0.31	2.03	3.14	2.12	0.088
	47	19	1	12.5	3.20	9 400		22.1	22.1	41	1	0.33	1.92	2.97	2.01	0.158
20	47	18	1	9.90	2.60	9 100	2204 2RS 2304 2RS	24.1	24.1	41	1	0.29	2.16	3.35	2.27	0.140
	52	21	1.1	12.4	3.35	8 300		26.2	26.2	45	1	0.30	2.12	3.28	2.22	0.209
25	52	18	1	12.1	3.30	7 900	2205 2RS 2305 2RS	29.4	29.4	46	1	0.28	2.28	3.52	2.39	0.163
	62	24	1.1	17.6	4.95	6 600		32	33.9	55	1	0.27	2.31	3.57	2.42	0.335
30	62	20	1	15.6	4.65	6 600	2206 2RS 2306 2RS	35.5	35.5	56	1	0.25	2.55	3.94	2.67	0.260
	72	27	1.1	21.3	6.30	5 800		37	37.8	65	1	0.26	2.40	3.72	2.52	0.500
35	72	23	1.1	15.8	5.10	5 700	2207 2RS 2307 2RS	40.9	40.9	65	1	0.23	2.71	4.20	2.84	0.403
	80	31	1.5	25.1	7.85	5 100		43.5	45.0	71.5	1.5	0.25	2.48	3.84	2.60	0.675
40	80	23	1.1	19.2	6.50	5 000	2208 2RS 2308 2RS	47	48.1	73	1	0.22	2.83	4.38	2.97	0.505
	90	33	1.5	29.5	9.70	4 600		48.5	49.6	81.5	1.5	0.25	2.57	3.98	2.69	0.925
45	85	23	1.1	21.8	7.35	4 600	2209 2RS 2309 2RS	52	52.4	78	1	0.21	2.94	4.56	3.09	0.545
	100	36	1.5	38.1	12.7	4 100		53.5	56.6	91.5	1.5	0.25	2.56	3.95	2.68	1.23
50	90	23	1.1	22.7	8.10	4 300	2210 2RS 2310 2RS	56.5	56.5	83	1	0.21	3.07	4.76	3.22	0.590
	110	40	2	43.4	14.1	3 700		60	62.5	100	2	0.23	2.70	4.17	2.83	1.64
55	100	25	1.5	26.8	10.0	3 900	2211 2RS 2311 2RS	63.5	63.5	91.5	1.5	0.20	3.19	4.94	3.34	0.810
	120	43	2	51.3	17.9	3 400		65	65	110	2	0.23	2.70	4.18	2.83	2.10

[Remark] Standard cage types used for the above bearings are described earlier in this section.

Self-aligning ball bearings
sealed type

d 60 ~ 110 mm

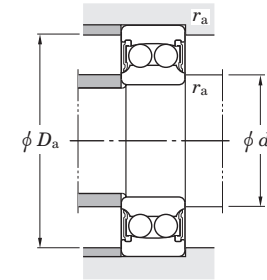
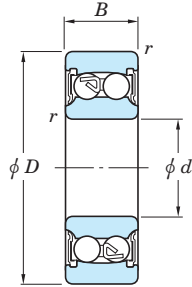

Boundary dimensions (mm)				Basic load ratings (kN)		Limiting speed (min ⁻¹)	Bearing No.	Mounting dimensions (mm)				Constant e	Axial load factors			(Refer.) Mass (kg)
d	D	B	$r_{min.}$	C_r	C_{Or}	Grease lub.		d_a min.	d_a max.	D_a max.	r_a max.		Y_1	Y_2	Y_0	
60	110	28	1.5	30.2	11.5	3 500	2212 2RS 2312 2RS	68.5	68.5	101.5	1.5	0.19	3.37	5.22	3.53	1.09
	130	46	2.1	57.1	20.8	3 000		72	72	118	2	0.22	2.91	4.50	3.05	2.60
65	120	31	1.5	31.0	12.5	3 200	2213 2RS 2313 2RS	73.5	75.5	111.5	1.5	0.17	3.67	5.68	3.84	1.46
	140	48	2.1	62.1	22.9	2 900		77	77	128	2	0.23	2.73	4.23	2.86	3.23
70	125	31	1.5	34.6	13.8	3 100	2214 2RS 2314 2RS	78.5	78.5	116.5	1.5	0.18	3.48	5.38	3.64	1.52
	150	51	2.1	74.1	27.7	2 600		82	82	138	2	0.22	2.84	4.40	2.98	4.23
75	130	31	1.5	38.8	15.7	2 900	2215 2RS 2315 2RS	83.5	83.5	121.5	1.5	0.17	3.60	5.58	3.77	1.62
	160	55	2.1	81.8	30.5	2 600		87	87	148	2	0.23	2.80	4.33	2.93	5.13
80	140	33	2	39.8	17.0	2 700	2216 2RS 2316 2RS	90	90	130	2	0.16	3.90	6.03	4.08	2.01
	170	58	2.1	88.4	33.1	2 300		92	92	158	2	0.22	2.90	4.49	3.04	6.10
85	150	36	2	49.2	20.8	2 500	2217 2RS	95	95	140	2	0.17	3.61	5.59	3.78	2.52
90	160	40	2	54.1	23.1	2 400	2218 2RS	100	100	150	2	0.17	3.69	5.70	3.86	3.40
95	170	43	2.1	60.8	26.8	2 200	2219 2RS	107	107	158	2	0.17	3.63	5.62	3.80	4.10
100	180	46	2.1	69.0	29.7	2 100	2220 2RS	112	112	168	2	0.17	3.62	5.60	3.79	4.98
105	190	50	2.1	77.0	34.0	2 000	2221 2RS	117	117	178	2	0.18	3.56	5.51	3.73	6.07
110	200	53	2.1	80.2	35.2	1 900	2222 2RS	122	122	188	2	0.17	3.64	5.63	3.81	7.10

[Remark] Standard cage types used for the above bearings are described earlier in this section.

Self-aligning ball bearings extended inner ring type

d 20 ~ 60 mm

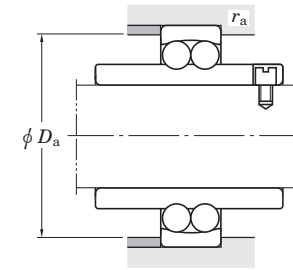
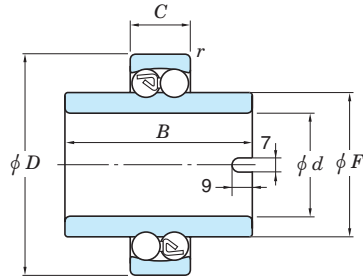

Boundary dimensions (mm)						Basic load ratings (kN)		Limiting speeds (min ⁻¹)		Bearing No.	Mounting dimensions (mm)		Constant e	Axial load factors			(Refer.) Mass (kg)
d	D	B	C	F	$r_{min.}$	C_r	C_{0r}	Grease lub.	Oil lub.		D_a max.	r_a max.		Y_1	Y_2	Y_0	
20	47	40	14	29.2	1	9.90	2.60	14 000	17 000	11204 11304	42	1	0.29	2.16	3.35	2.27	0.191
	52	44	15	31.5	1.1	12.4	3.35	13 000	15 000		45.5	1	0.30	2.12	3.28	2.22	0.266
25	52	44	15	33.3	1	12.1	3.30	12 000	14 000	11205 11305	47	1	0.28	2.28	3.52	2.39	0.226
	62	48	17	38	1.1	17.6	4.95	9 900	12 000		55.5	1	0.27	2.31	3.57	2.42	0.445
30	62	48	16	40.1	1	15.6	4.65	9 900	12 000	11206 11306	57	1	0.25	2.55	3.94	2.67	0.360
	72	52	19	45	1.1	21.3	6.30	8 700	11 000		65.5	1	0.26	2.40	3.72	2.52	0.614
35	72	52	17	47.7	1.1	15.8	5.10	8 500	10 000	11207 11307	65.5	1	0.23	2.71	4.20	2.84	0.556
	80	56	21	51.7	1.5	25.1	7.85	7 600	9 300		72	1.5	0.25	2.48	3.84	2.60	0.821
40	80	56	18	54	1.1	19.2	6.50	7 500	9 200	11208 11308	73.5	1	0.22	2.83	4.38	2.97	0.733
	90	58	23	57.7	1.5	29.5	9.70	6 900	8 400		82	1.5	0.25	2.57	3.98	2.69	1.09
45	85	58	19	57.7	1.1	21.8	7.35	7 000	8 500	11209 11309	78.5	1	0.21	2.94	4.56	3.09	0.793
	100	60	25	63.9	1.5	38.1	12.7	6 100	7 500		92	1.5	0.25	2.56	3.95	2.68	1.40
50	90	58	20	62.7	1.1	22.7	8.10	6 500	7 900	11210 11310	83.5	1	0.21	3.07	4.76	3.22	0.875
	110	62	27	70.3	2	43.4	14.1	5 600	6 800		102	2	0.23	2.70	4.17	2.83	1.74
55	100	60	21	70.3	1.5	26.8	10.0	5 800	7 100	11211	93.5	1.5	0.20	3.19	4.94	3.34	1.16
60	110	62	22	78	1.5	30.2	11.5	5 200	6 400	11212	103.5	1.5	0.19	3.37	5.22	3.53	1.52

Adapter assemblies for self-aligning ball bearings

d_1 17 ~ (45) mm

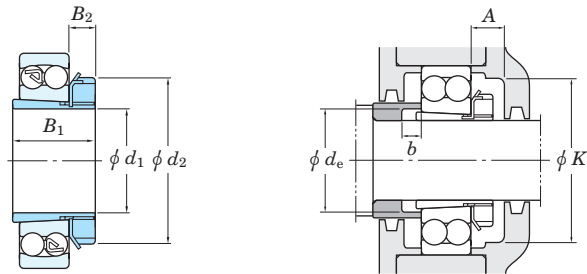

Boundary dimensions (mm)				Brg. bore d (mm)	Designations Bearing + adapter ass'y	Mounting dimensions (mm)				Mass Brg.+adapter ass'y (kg)	(Refer.)	
d_1	B_1	d_2	B_2			A min.	K min.	d_e min.	b min.		Adapter sleeve No.	Locknut No.
17	24	32	7	20	1204K+H204X	—	—	23	5	0.162	A204X	AN04
	28	32	7	20	2204K+H304X	—	—	24	5	0.185	A304X	AN04
	28	32	7	20	1304K+H304X	—	—	24	8	0.210	A304X	AN04
	31	32	7	20	2304K+H2304X	—	—	24	5	0.257	A2304X	AN04
20	26	38	8	25	1205K+H205X	15	45	28	5	0.218	A205X	AN05
	29	38	8	25	2205K+H305X	15	45	29	5	0.243	A305X	AN05
	29	38	8	25	1305K+H305X	15	45	29	6	0.337	A305X	AN05
	35	38	8	25	2305K+H2305X	15	45	29	5	0.424	A2305X	AN05
25	27	45	8	30	1206K+H206X	15	50	33	5	0.320	A206X	AN06
	31	45	8	30	2206K+H306X	15	50	34	5	0.368	A306X	AN06
	31	45	8	30	1306K+H306X	15	50	34	6	0.495	A306X	AN06
	38	45	8	30	2306K+H2306X	15	50	35	5	0.620	A2306X	AN06
30	29	52	9	35	1207K+H207X	17	58	38	5	0.462	A207X	AN07
	35	52	9	35	2207K+H307X	17	58	39	5	0.557	A307X	AN07
	35	52	9	35	1307K+H307X	17	58	39	7	0.663	A307X	AN07
	43	52	9	35	2307K+H2307X	17	58	40	5	0.843	A2307X	AN07
35	31	58	10	40	1208K+H208X	17	65	44	5	0.597	A208X	AN08
	36	58	10	40	2208K+H308X	17	65	44	5	0.696	A308X	AN08
	36	58	10	40	1308K+H308X	17	65	44	5	0.906	A308X	AN08
	46	58	10	40	2308K+H2308X	17	65	45	5	1.14	A2308X	AN08
40	33	65	11	45	1209K+H209X	17	72	49	5	0.701	A209X	AN09
	39	65	11	45	2209K+H309X	17	72	49	8	0.798	A309X	AN09
	39	65	11	45	1309K+H309X	17	72	49	5	1.21	A309X	AN09
	50	65	11	45	2309K+H2309X	17	72	50	5	1.51	A2309X	AN09
45	35	70	12	50	1210K+H210X	19	76	53	5	0.804	A210X	AN10
	42	70	12	50	2210K+H310X	19	76	54	10	0.896	A310X	AN10

d_1 (45) ~ 75 mm

Boundary dimensions (mm)				Brg. bore d (mm)	Designations Bearing + adapter ass'y	Mounting dimensions (mm)				Mass Brg.+adapter ass'y (kg)	(Refer.)	
d_1	B_1	d_2	B_2			A min.	K min.	d_e min.	b min.		Adapter sleeve No.	Locknut No.
45	42	70	12	50	1310K+H310X	19	76	54	5	1.51	A310X	AN10
	55	70	12	50	2310K+H2310X	19	76	56	5	1.98	A2310X	AN10
50	37	75	12	55	1211K+H211X	19	85	60	6	1.02	A211X	AN11
	45	75	12	55	2211K+H311X	19	85	60	11	1.16	A311X	AN11
	45	75	12	55	1311K+H311X	19	85	60	6	1.93	A311X	AN11
	59	75	12	55	2311K+H2311X	19	85	61	6	2.50	A2311X	AN11
55	38	80	13	60	1212K+H212X	20	90	61	5	1.25	A212X	AN12
	47	80	13	60	2212K+H312X	20	90	65	9	1.49	A312X	AN12
	47	80	13	60	1312K+H312X	20	90	65	5	2.35	A312X	AN12
	62	80	13	60	2312K+H2312X	20	90	66	5	3.04	A2312X	AN12
60	40	85	14	65	1213K+H213X	21	96	70	5	1.56	A213X	AN13
	50	85	14	65	2213K+H313X	21	96	70	8	1.92	A313X	AN13
	50	85	14	65	1313K+H313X	21	96	70	5	2.90	A313X	AN13
	65	85	14	65	2313K+H2313X	21	96	72	5	3.74	A2313X	AN13
65	43	98	15	75	1215K+H215X	23	110	80	5	2.09	A215X	AN15
	55	98	15	75	2215K+H315X	23	110	80	12	2.47	A315X	AN15
	55	98	15	75	1315K+H315X	23	110	80	5	4.40	A315X	AN15
	73	98	15	75	2315K+H2315X	23	110	82	5	6.12	A2315X	AN15
70	46	105	17	80	1216K+H216X	25	120	85	5	2.57	A216X	AN16
	59	105	17	80	2216K+H316X	25	120	86	12	3.06	A316X	AN16
	59	105	17	80	1316K+H316X	25	120	86	5	5.21	A316X	AN16
	78	105	17	80	2316K+H2316X	25	120	87	5	7.30	A2316X	AN16
75	50	110	18	85	1217K+H217X	27	128	90	6	3.11	A217X	AN17
	63	110	18	85	2217K+H317X	27	128	91	12	3.70	A317X	AN17
	63	110	18	85	1317K+H317X	27	128	91	6	6.15	A317X	AN17
	82	110	18	85	2317K+H2317X	27	128	94	6	8.41	A2317X	AN17

Adapter assemblies for self-aligning ball bearings

d_1 80 ~ 100 mm

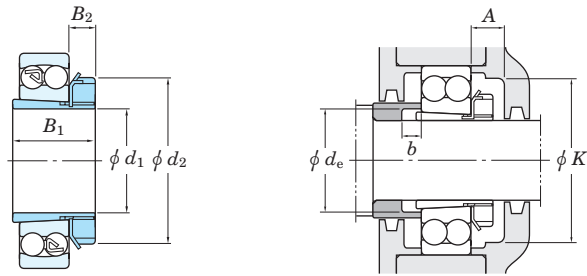

Boundary dimensions (mm)				Brg. bore d (mm)	Designations Bearing + adapter ass'y	Mounting dimensions (mm)				Mass Brg.+adapter ass'y (kg)	(Refer.)	
d_1	B_1	d_2	B_2			A min.	K min.	d_e min.	b min.		Adapter sleeve No.	Locknut No.
80	52	120	18	90	1218K+H218X	28	139	95	6	3.75	A218X	AN18
	65	120	18	90	2218K+H318X	28	139	96	10	4.78	A318X	AN18
	65	120	18	90	1318K+H318X	28	139	96	6	7.16	A318X	AN18
	86	120	18	90	2318K+H2318X	28	139	99	6	9.95	A2318X	AN18
85	55	125	19	95	1219K+H219X	29	145	101	7	4.47	A219X	AN19
	68	125	19	95	2219K+H319X	29	145	102	9	5.62	A319X	AN19
	68	125	19	95	1319K+H319X	29	145	102	7	8.21	A319X	AN19
	90	125	19	95	2319K+H2319X	29	145	105	7	11.6	A2319X	AN19
90	58	130	20	100	1220K+H220X	30	150	106	7	5.23	A220X	AN20
	71	130	20	100	2220K+H320X	30	150	107	8	6.67	A320X	AN20
	71	130	20	100	1320K+H320X	30	150	107	7	9.99	A320X	AN20
	97	130	20	100	2320K+H2320X	30	150	110	7	14.4	A2320X	AN20
100	63	145	21	110	1222K+H222X	32	170	116	7	7.10	A222X	AN22
	77	145	21	110	2222K+H322X	32	170	117	6	9.23	A322X	AN22
	77	145	21	110	1322K+H322X	32	170	117	9	14.0	A322X	AN22
	105	145	21	110	2322K+H2322X	32	170	121	7	19.8	A2322X	AN22

Cylindrical roller bearings

Cylindrical roller bearings feature high radial load capacity because the rollers and raceway are in linear contact. These bearings are suitable for applications that involve heavy radial and impact loading.

They are also appropriate for high-speed applications in that they can be machined very accurately due to their structure.

Having a separable inner ring or outer ring, these bearings can be mounted and dismantled easily.

■ Single-row cylindrical roller bearings

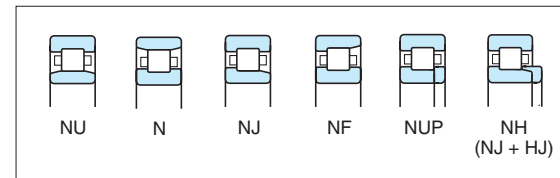

- The NU and N types exhibit their best performance when used as free side bearings since they adjust to the shaft's axial movement, to a certain extent, relative to the housing position.
- The NJ and NF types carry axial load in one direction, while the NUP and NH types can carry a certain degree of axial load in both directions.
- Type R cylindrical roller bearings feature enhanced load rating compared with standard series, though both have equal dimensions. This is because type R bearings have different internal design. They are identified by supplementary code "R".

■ Double-row cylindrical roller bearings

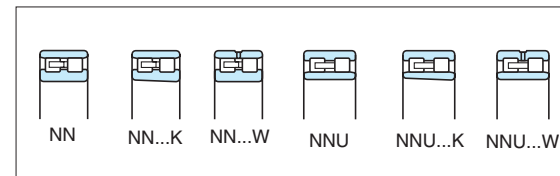

- Double-row cylindrical roller bearings come in two types : with a cylindrical bore, and with a tapered bore. As for those with a tapered bore, the specified amount of clearance can be obtained by adjusting the press-in distance. Some bearings have lubrication holes and lubrication grooves on the outer ring. They are identified by supplementary code "W".
- These bearings can accommodate high radial loads, and are often used on machine tool spindles.

Single-row cylindrical roller bearings



Bore diameter **20 – 460 mm**



Thrust collar

Bore diameter **20 – 320 mm**

Double-row cylindrical roller bearings

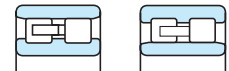

NN

NNU

Bore diameter **25 – 480 mm**



Boundary dimensions	The dimensions of standard series are as specified in JIS B 1512.																																																											
Tolerances	As specified in JIS B 1514-1 (refer to Table 7-3 on pp. A 54 – A 57).																																																											
	Tolerances of roller set bore diameter F_w and roller set outside diameter E_w of interchangeable bearings are as follows : Unit : μm																																																											
	<table border="1"> <thead> <tr> <th colspan="2">Nominal bore diameter d (mm)</th> <th colspan="2">Δ_{F_w} Roller set bore diameter deviation</th> <th colspan="2">Δ_{E_w} Roller set outside diameter deviation</th> </tr> <tr> <th>over</th> <th>up to</th> <th>upper</th> <th>lower</th> <th>upper</th> <th>lower</th> </tr> </thead> <tbody> <tr> <td>–</td> <td>20</td> <td>+ 10</td> <td>0</td> <td>0</td> <td>– 10</td> </tr> <tr> <td>20</td> <td>50</td> <td>+ 15</td> <td>0</td> <td>0</td> <td>– 15</td> </tr> <tr> <td>50</td> <td>120</td> <td>+ 20</td> <td>0</td> <td>0</td> <td>– 20</td> </tr> <tr> <td>120</td> <td>200</td> <td>+ 25</td> <td>0</td> <td>0</td> <td>– 25</td> </tr> <tr> <td>200</td> <td>250</td> <td>+ 30</td> <td>0</td> <td>0</td> <td>– 30</td> </tr> <tr> <td>250</td> <td>315</td> <td>+ 35</td> <td>0</td> <td>0</td> <td>– 35</td> </tr> <tr> <td>315</td> <td>400</td> <td>+ 40</td> <td>0</td> <td>0</td> <td>– 40</td> </tr> <tr> <td>400</td> <td>500</td> <td>+ 45</td> <td>0</td> <td>–</td> <td>–</td> </tr> </tbody> </table>	Nominal bore diameter d (mm)		Δ_{F_w} Roller set bore diameter deviation		Δ_{E_w} Roller set outside diameter deviation		over	up to	upper	lower	upper	lower	–	20	+ 10	0	0	– 10	20	50	+ 15	0	0	– 15	50	120	+ 20	0	0	– 20	120	200	+ 25	0	0	– 25	200	250	+ 30	0	0	– 30	250	315	+ 35	0	0	– 35	315	400	+ 40	0	0	– 40	400	500	+ 45	0	–
Nominal bore diameter d (mm)		Δ_{F_w} Roller set bore diameter deviation		Δ_{E_w} Roller set outside diameter deviation																																																								
over	up to	upper	lower	upper	lower																																																							
–	20	+ 10	0	0	– 10																																																							
20	50	+ 15	0	0	– 15																																																							
50	120	+ 20	0	0	– 20																																																							
120	200	+ 25	0	0	– 25																																																							
200	250	+ 30	0	0	– 30																																																							
250	315	+ 35	0	0	– 35																																																							
315	400	+ 40	0	0	– 40																																																							
400	500	+ 45	0	–	–																																																							
	[Remark] Interchangeable bearings have an inner ring with rollers that can be matched with the outer ring, or an outer ring with rollers that can be matched with the inner ring, without affecting performance in the bearing that has the same bearing number in one category.																																																											
	Tapered bore tolerance and allowable values of high precision double-row cylindrical roller bearings (classes 5 and 4) are provided in JTEKT standards (refer to Table 7-11 on p. A 70).																																																											
Radial internal clearance	· Cylindrical bore and tapered bore bearings(refer to Table 10-8 on pp. A 100, 101.) · Motor bearings.....(refer to Table 10-7 on p. A 99.)																																																											
Recommended fits	Refer to Table 9-4 on pp. A 85, 86.																																																											
Standard cages	<ul style="list-style-type: none"> ■ For single-row cylindrical roller bearings : <ul style="list-style-type: none"> · Pressed steel cage (supplementary code : //) · Copper alloy machined cage (supplementary code : FY) (Copper alloy machined cages without rivets (LY) are also used for some special purposes.) ■ For double-row cylindrical roller bearings : <ul style="list-style-type: none"> · Prong type copper alloy machined cage (supplementary code : FY) · Separable prong type copper alloy machined cage (supplementary code : FW)for class 5 or higher precision bearings 																																																											

Allowable misalignment	Allowable misalignment of single-row cylindrical roller bearings depends on bearing type and specification. General values are as follows : 1) When P_r/C_r is approx. 10% under load of normal use0.000 6 rad (2') – 0.000 9 rad (3') 2) When P_r/C_r is approx. 6% under load lighter than 1)0.001 2 rad (4') When very large allowable misalignment is required, consult with JTEKT.
Equivalent radial load	Dynamic equivalent radial load $P_r = F_r$ Static equivalent radial load $P_{0r} = F_r$
Allowable axial load	Cylindrical roller bearings with ribs, including loose rib and thrust collar, on both inner and outer rings accommodate axial load to a certain extent. (NJ and NF types accommodate load applied in one direction : NUP and NH in both directions.) For calculation of allowable axial load, refer to p. A 40.

Table 1 Application of standard cages

Bearing series	Pressed cage	Machined cage
NU, NUP 10	—	1005 – 1092
NU, NJ, NUP, NF 2	204 – 220	204 – 264
NU, NJ, NUP 2 R	204R – 220R	204R – 240R
NU, NJ, NUP 22	2204 – 2220	2204 – 2252
NU, NJ, NUP 22 R	2204R – 2220R	2204R – 2240R
NU 32	—	3206 – 3252
NU, NJ, NUP, NF 3	304 – 320	304 – 348
NU, NJ, NUP 3 R	304R – 320R	304R – 332R
NU, NJ, NUP 23	2304 – 2320	2304 – 2340
NU, NJ, NUP 23 R	2304R – 2320R	2304R – 2332R
NU 33	—	3306 – 3352
NU, NJ, NUP, NF 4	406 – 420	406 – 430

Single-row cylindrical roller bearings

d 20 ~ (30) mm

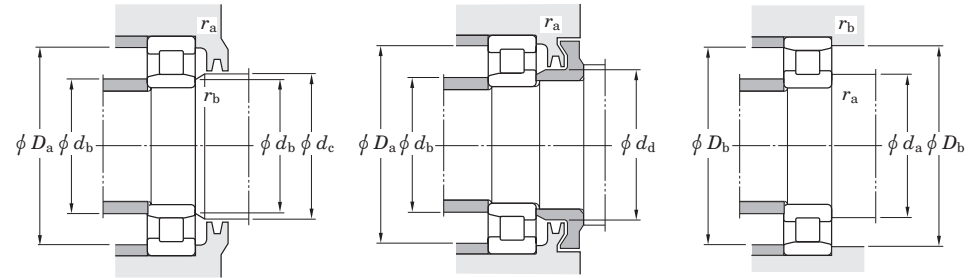
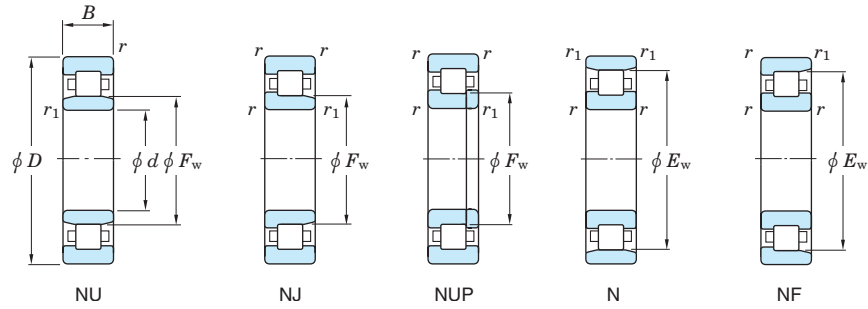

d	Boundary dimensions (mm)						Basic load ratings (kN)		Limiting speeds (min ⁻¹)		Bearing No.					Mounting dimensions (mm)								Mass NU (kg)		
	D	B	r min.	r_1 min.	F_w	E_w	C_r	C_{0r}	Grease lub.	Oil lub.	NU	NJ	NUP	N	NF	d_a min.	d_b min. max.	d_c min.	d_a min. max.	D_a max.	D_b max. min.	r_a max.	r_b max.			
20	47	14	1	0.6	27	40	15.4	12.7	15 000	18 000	NU204	NJ204	NUP204	N204	NF204	25	24	26	29	32	42	43	42	1	0.6	0.108
	47	14	1	0.6	26.5	—	25.7	22.6	15 000	18 000	NU204R	NJ204R	NUP204R	—	—	25	24	26	29	32	42	—	—	1	0.6	0.112
	47	18	1	0.6	27	—	20.7	18.4	13 000	18 000	NU2204	NJ2204	NUP2204	—	—	25	24	26	29	32	42	—	—	1	0.6	0.146
	47	18	1	0.6	26.5	—	30.6	28.3	13 000	18 000	NU2204R	NJ2204R	NUP2204R	—	—	25	24	26	29	32	42	—	—	1	0.6	0.146
	52	15	1.1	0.6	28.5	44.5	23.1	19.2	12 000	16 000	NU304	NJ304	NUP304	N304	NF304	26.5	24	27	30	33	45.5	48	45.5	1	0.6	0.147
	52	15	1.1	0.6	27.5	—	31.5	26.9	12 000	16 000	NU304R	NJ304R	NUP304R	—	—	26.5	24	27	30	33	45.5	—	—	1	0.6	0.153
	52	21	1.1	0.6	28.5	—	32.9	30.2	11 000	16 000	NU2304	NJ2304	NUP2304	—	—	26.5	24	27	30	33	45.5	—	—	1	0.6	0.212
	52	21	1.1	0.6	27.5	—	42.0	38.8	11 000	16 000	NU2304R	NJ2304R	NUP2304R	—	—	26.5	24	27	30	33	45.5	—	—	1	1	0.215
25	47	12	0.6	0.3	30.5	—	14.3	13.1	15 000	18 000	NU1005	—	NUP1005	—	—	29	27	30	32	—	43	—	—	0.6	0.3	0.084
	52	15	1	0.6	32	45	17.7	15.7	13 000	16 000	NU205	NJ205	NUP205	N205	NF205	30	29	31	34	37	47	48	47	1	0.6	0.132
	52	15	1	0.6	31.5	—	29.3	27.7	13 000	15 000	NU205R	NJ205R	NUP205R	—	—	30	29	31	34	37	47	—	—	1	0.6	0.138
	52	18	1	0.6	32	—	23.7	22.8	12 000	16 000	NU2205	NJ2205	NUP2205	—	—	30	29	31	34	37	47	—	—	1	0.6	0.163
	52	18	1	0.6	31.5	—	34.9	34.6	12 000	15 000	NU2205R	NJ2205R	NUP2205R	—	—	30	29	31	34	37	47	—	—	1	0.6	0.166
	62	17	1.1	1.1	35	53	29.3	25.2	10 000	14 000	NU305	NJ305	NUP305	N305	NF305	31.5	31.5	33	37	40	55.5	55.5	55	1	1	0.241
	62	17	1.1	1.1	34	—	41.6	37.4	10 000	14 000	NU305R	NJ305R	NUP305R	—	—	31.5	31.5	33	37	40	55.5	—	—	1	1	0.243
	62	24	1.1	1.1	35	—	42.7	40.9	9 100	14 000	NU2305	NJ2305	NUP2305	—	—	31.5	31.5	33	37	40	55.5	—	—	1	1	0.340
62	24	1.1	1.1	34	—	57.0	56.1	9 100	14 000	NU2305R	NJ2305R	NUP2305R	—	—	31.5	31.5	33	37	40	55.5	—	—	1	1	0.350	
30	55	13	1	0.6	36.5	—	18.7	18.4	13 000	15 000	NU1006	—	NUP1006	—	—	35	34	35	38	—	50	—	—	1	0.6	0.121
	62	16	1	0.6	38.5	53.5	23.5	21.5	11 000	13 000	NU206	NJ206	NUP206	N206	NF206	35	34	37	40	44	57	58	56	1	0.6	0.200
	62	16	1	0.6	37.5	—	39.1	37.4	11 000	13 000	NU206R	NJ206R	NUP206R	—	—	35	34	37	40	44	57	—	—	1	0.6	0.209
	62	20	1	0.6	38.5	—	32.9	33.1	9 800	13 000	NU2206	NJ2206	NUP2206	—	—	35	34	37	40	44	57	—	—	1	0.6	0.262
	62	20	1	0.6	37.5	—	48.9	49.8	9 700	13 000	NU2206R	NJ2206R	NUP2206R	—	—	35	34	37	40	44	57	—	—	1	0.6	0.262
	62	23.8	1	1	38.5	—	42.7	46.4	8 700	13 000	NU3206	—	—	—	—	35	35	37	40	—	57	—	—	1	0.6	0.343
	72	19	1.1	1.1	42	62	38.6	35.2	8 700	12 000	NU306	NJ306	NUP306	N306	NF306	36.5	36.5	40	44	48	65.5	65.5	64	1	1	0.358
	72	19	1.1	1.1	40.5	—	53.1	50.2	8 700	12 000	NU306R	NJ306R	NUP306R	—	—	36.5	36.5	40	44	48	65.5	—	—	1	1	0.361
72	27	1.1	1.1	42	—	51.4	50.8	7 700	12 000	NU2306	NJ2306	NUP2306	—	—	36.5	36.5	40	44	48	65.5	—	—	1	1	0.500	
72	27	1.1	1.1	40.5	—	74.6	77.6	7 800	12 000	NU2306R	NJ2306R	NUP2306R	—	—	36.5	36.5	40	44	48	65.5	—	—	1	1	0.534	

[Remarks] 1) Standard cage types used for the above bearings are shown in Table 1 earlier in this section. Please note that basic load ratings and limiting speeds shown above indicate the value applicable to machined cage. Consult JTEKT about bearings with pressed cage, since they may be different from bearings with machined cage in values above.

2) Bearing numbers of NU and NJ type bearings with mounted thrust collar (refer to specification table shown after this specification table) are NUJ and NH.

Single-row cylindrical roller bearings

d (30) ~ (45) mm

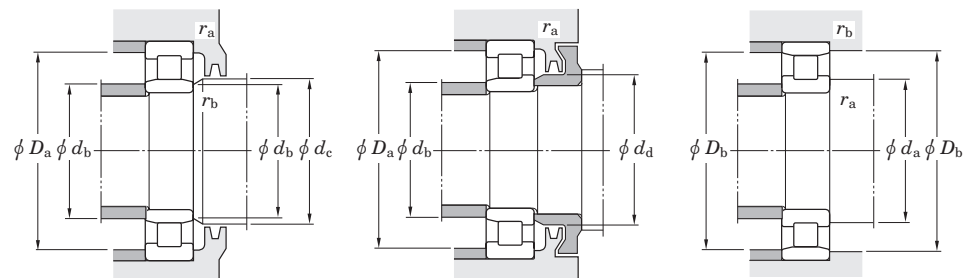
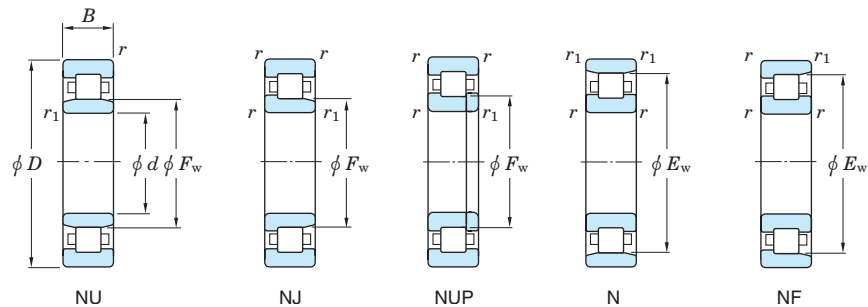

Boundary dimensions (mm)							Basic load ratings (kN)		Limiting speeds (min ⁻¹)		Bearing No.					Mounting dimensions (mm)								(Refer.)		
d	D	B	r min.	r1 min.	Fw	Ew	Cr	C0r	Grease lub.	Oil lub.	NU	NJ	NUP	N	NF	da min.	db min.	db max.	dc min.	da min.	Da max.	Db max.	Db min.	ra max.	rb max.	Mass NU (kg)
30	72	30.2	1.1	1.1	42	—	69.1	74.3	7 700	12 000	NU3306	—	—	—	—	36.5	36.5	40	44	—	65.5	—	—	1	1	0.650
	90	23	1.5	1.5	45	73	62.8	55.0	7 600	10 000	NU406	NJ406	NUP406	N406	NF406	38	38	44	47	52	82	82	74	1.5	1.5	0.753
35	62	14	1	0.6	42	—	22.6	23.2	11 000	13 000	NU1007	—	NUP1007	—	—	40	39	41	44	—	57	—	—	1	0.5	0.182
	72	17	1.1	0.6	43.8	61.8	33.6	31.5	9 500	11 000	NU207	NJ207	NUP207	N207	NF207	41.5	39	43	46	50	65.5	68	64	1	0.6	0.293
	72	17	1.1	0.6	44	—	50.2	50.2	9 300	11 000	NU207R	NJ207R	NUP207R	—	—	41.5	39	43	46	50	65.5	—	—	1	0.6	0.306
	72	23	1.1	0.6	43.8	—	49.0	51.2	8 500	11 000	NU2207	NJ2207	NUP2207	—	—	41.5	39	43	46	50	65.5	—	—	1	0.6	0.402
	72	23	1.1	0.6	44	—	61.6	65.3	8 300	11 000	NU2207R	NJ2207R	NUP2207R	—	—	41.5	39	43	46	50	65.5	—	—	1	0.6	0.404
	72	27	1.1	1.1	43.8	—	54.8	59.1	7 600	11 000	NU3207	—	—	—	—	41.5	41.5	43	46	—	65.5	—	—	1	0.6	0.524
	80	21	1.5	1.1	46.2	68.2	49.6	46.9	7 900	10 000	NU307	NJ307	NUP307	N307	NF307	43	41.5	45	48	53	72	73.5	71	1.5	1	0.477
	80	21	1.5	1.1	46.2	—	66.6	65.4	7 700	10 000	NU307R	NJ307R	NUP307R	—	—	43	41.5	45	48	53	72	—	—	1.5	1	0.482
	80	31	1.5	1.1	46.2	—	64.4	65.7	7 000	10 000	NU2307	NJ2307	NUP2307	—	—	43	41.5	45	48	53	72	—	—	1.5	1	0.696
	80	31	1.5	1.1	46.2	—	93.1	101	6 900	10 000	NU2307R	NJ2307R	NUP2307R	—	—	43	41.5	45	48	53	72	—	—	1.5	1	0.729
	80	34.9	1.5	1.5	46.2	—	81.7	89.1	7 000	10 000	NU3307	—	—	—	—	43	43	45	48	—	72	—	—	1.5	1	0.908
	100	25	1.5	1.5	53	83	75.2	68.9	6 600	8 800	NU407	NJ407	NUP407	N407	NF407	43	43	52	55	61	92	92	84	1.5	1.5	1.02
40	68	15	1	0.6	47	—	24.9	25.7	10 000	12 000	NU1008	—	NUP1008	—	—	45	44	46	49	—	63	—	—	1	0.6	0.223
	80	18	1.1	1.1	50	70	43.8	42.9	8 300	10 000	NU208	NJ208	NUP208	N208	NF208	46.5	46.5	49	52	56	73.5	73.5	72	1	1	0.366
	80	18	1.1	1.1	49.5	—	55.7	55.4	8 300	9 900	NU208R	NJ208R	NUP208R	—	—	46.5	46.5	49	52	56	73.5	—	—	1	1	0.384
	80	23	1.1	1.1	50	—	58.3	62.0	7 500	10 000	NU2208	NJ2208	NUP2208	—	—	46.5	46.5	49	52	56	73.5	—	—	1	1	0.490
	80	23	1.1	1.1	49.5	—	72.3	77.6	7 400	9 900	NU2208R	NJ2208R	NUP2208R	—	—	46.5	46.5	49	52	56	73.5	—	—	1	1	0.490
	80	30.2	1.1	1.1	50	—	78.3	90.6	6 700	10 000	NU3208	—	—	—	—	46.5	46.5	49	52	—	73.5	—	—	1	1	0.711
	90	23	1.5	1.5	53.5	77.5	58.6	56.9	6 900	9 100	NU308	NJ308	NUP308	N308	NF308	48	48	51	55	60	82	82	80	1.5	1.5	0.657
	90	23	1.5	1.5	52	—	83.1	81.5	6 800	9 100	NU308R	NJ308R	NUP308R	—	—	48	48	51	55	60	82	—	—	1.5	1.5	0.664
	90	33	1.5	1.5	53.5	—	82.2	88.0	6 100	9 100	NU2308	NJ2308	NUP2308	—	—	48	48	51	55	60	82	—	—	1.5	1.5	0.956
	90	33	1.5	1.5	52	—	114	122	6 100	9 100	NU2308R	NJ2308R	NUP2308R	—	—	48	48	51	55	60	82	—	—	1.5	1.5	0.962
	90	36.5	1.5	1.5	53.5	—	104	119	6 100	9 100	NU3308	—	—	—	—	48	48	51	55	—	82	—	—	1.5	1.5	1.19
	110	27	2	2	58	92	97.1	89.1	6 000	8 000	NU408	NJ408	NUP408	N408	NF408	49	49	57	60	67	101	101	93	2	2	1.30
45	75	16	1	0.6	52.5	—	31.0	33.8	9 200	11 000	NU1009	—	NUP1009	—	—	50	49	52	54	—	70	—	—	1	0.6	0.289

[Remarks] 1) Standard cage types used for the above bearings are shown in Table 1 earlier in this section. Please note that basic load ratings and limiting speeds shown above indicate the value applicable to machined cage. Consult JTEKT about bearings with pressed cage, since they may be different from bearings with machined cage in values above.

2) Bearing numbers of NU and NJ type bearings with mounted thrust collar (refer to specification table shown after this specification table) are NUJ and NH.

Single-row cylindrical roller bearings

d (45) ~ (55) mm

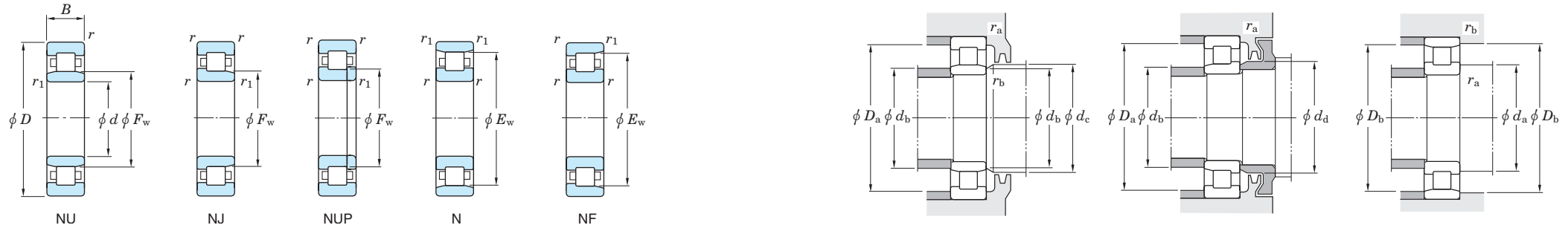

Boundary dimensions (mm)							Basic load ratings (kN)		Limiting speeds (min ⁻¹)		Bearing No.					Mounting dimensions (mm)								(Refer.)		
d	D	B	r min.	r_1 min.	F_w	E_w	C_r	C_{0r}	Grease lub.	Oil lub.	NU	NJ	NUP	N	NF	d_a min.	d_b min.	d_b max.	d_c min.	d_d min.	D_a max.	D_b max.	r_a min.	r_b max.	Mass NU (kg)	
45	85	19	1.1	1.1	55	75	46.1	46.9	7 700	9 200	NU209	NJ209	NUP209	N209	NF209	51.5	51.5	54	57	61	78.5	78.5	77	1	1	0.427
	85	19	1.1	1.1	54.5	—	63.1	66.4	7 600	9 200	NU209R	NJ209R	NUP209R	—	—	51.5	51.5	54	57	61	78.5	—	—	1	1	0.439
	85	23	1.1	1.1	55	—	61.4	67.8	6 900	9 200	NU2209	NJ2209	NUP2209	—	—	51.5	51.5	54	57	61	78.5	—	—	1	1	0.536
	85	23	1.1	1.1	54.5	—	76.1	84.6	6 900	9 200	NU2209R	NJ2209R	NUP2209R	—	—	51.5	51.5	54	57	61	78.5	—	—	1	1	0.536
	85	30.2	1.1	1.1	55	—	82.4	99.0	6 100	9 200	NU3209	—	—	—	—	51.5	51.5	54	57	—	78.5	—	—	1	1	0.770
	100	25	1.5	1.5	58.5	86.5	78.8	77.5	6 200	8 300	NU309	NJ309	NUP309	N309	NF309	53	53	57	60	66	92	92	89	1.5	1.5	0.870
	100	25	1.5	1.5	58.5	—	97.4	98.3	6 100	8 200	NU309R	NJ309R	NUP309R	—	—	53	53	57	60	66	92	—	—	1.5	1.5	0.909
	100	36	1.5	1.5	58.5	—	106	113	5 500	8 300	NU2309	NJ2309	NUP2309	—	—	53	53	57	60	66	92	—	—	1.5	1.5	1.25
	100	36	1.5	1.5	58.5	—	137	153	5 400	8 200	NU2309R	NJ2309R	NUP2309R	—	—	53	53	57	60	66	92	—	—	1.5	1.5	1.32
	100	39.7	1.5	1.5	58.5	—	131	149	5 500	8 300	NU3309	—	—	—	—	53	53	57	60	—	92	—	—	1.5	1.5	1.59
120	29	2	2	64.5	100.5	115	112	5 400	7 200	NU409	NJ409	NUP409	N409	NF409	54	54	63	66	74	111	111	102	2	2	1.64	
50	80	16	1	0.6	57.5	—	33.6	36.8	8 400	9 900	NU1010	—	NUP1010	—	—	55	54	57	59	—	75	—	—	1	0.6	0.306
	90	20	1.1	1.1	60.4	80.4	48.2	51.0	7 100	8 500	NU210	NJ210	NUP210	N210	NF210	56.5	56.5	58	62	67	83.5	83.5	82	1	1	0.479
	90	20	1.1	1.1	59.5	—	66.1	71.9	7 100	8 500	NU210R	NJ210R	NUP210R	—	—	56.5	56.5	58	62	67	83.5	—	—	1	1	0.497
	90	23	1.1	1.1	60.4	—	64.2	73.6	6 400	8 500	NU2210	NJ2210	NUP2210	—	—	56.5	56.5	58	62	67	83.5	—	—	1	1	0.580
	90	23	1.1	1.1	59.5	—	79.7	91.5	6 400	8 500	NU2210R	NJ2210R	NUP2210R	—	—	56.5	56.5	58	62	67	83.5	—	—	1	1	0.580
	90	30.2	1.1	1.1	60.4	—	86.2	108	5 700	8 500	NU3210	—	—	—	—	56.5	56.5	58	62	—	83.5	—	—	1	1	0.829
	110	27	2	2	65	95	92.2	93.4	5 600	7 500	NU310	NJ310	NUP310	N310	NF310	59	59	63	67	73	101	101	98	2	2	1.15
	110	27	2	2	65	—	110	113	5 500	7 400	NU310R	NJ310R	NUP310R	—	—	59	59	63	67	73	101	—	—	2	2	1.15
	110	40	2	2	65	—	128	142	5 000	7 500	NU2310	NJ2310	NUP2310	—	—	59	59	63	67	73	101	—	—	2	2	1.69
	110	40	2	2	65	—	163	187	4 900	7 400	NU2310R	NJ2310R	NUP2310R	—	—	59	59	63	67	73	101	—	—	2	2	1.76
110	44.4	2	2	65	—	156	183	5 000	7 500	NU3310	—	—	—	—	59	59	63	67	—	101	—	—	2	2	2.14	
130	31	2.1	2.1	70.8	110.8	139	136	4 900	6 600	NU410	NJ410	NUP410	N410	NF410	61	61	69	73	81	119	119	112	2	2	2.01	
55	90	18	1.1	1	64.5	—	37.4	43.8	7 600	8 900	NU1011	—	NUP1011	—	—	61.5	60	63	66	—	83.5	—	—	1	1	0.445
	100	21	1.5	1.1	66.5	88.5	58.0	62.3	6 400	7 700	NU211	NJ211	NUP211	N211	NF211	63	61.5	65	68	73	92	93.5	91	1.5	1	0.640
	100	21	1.5	1.1	66	—	86.4	98.7	6 400	7 700	NU211R	NJ211R	NUP211R	—	—	63	61.5	65	68	73	92	—	—	1.5	1	0.650
	100	25	1.5	1.1	66.5	—	75.3	87.2	5 800	7 700	NU2211	NJ2211	NUP2211	—	—	63	61.5	65	68	73	92	—	—	1.5	1	0.780

[Remarks] 1) Standard cage types used for the above bearings are shown in Table 1 earlier in this section. Please note that basic load ratings and limiting speeds shown above indicate the value applicable to machined cage. Consult JTEKT about bearings with pressed cage, since they may be different from bearings with machined cage in values above.

2) Bearing numbers of NU and NJ type bearings with mounted thrust collar (refer to specification table shown after this specification table) are NUJ and NH.

Single-row cylindrical roller bearings

d (55) ~ (65) mm

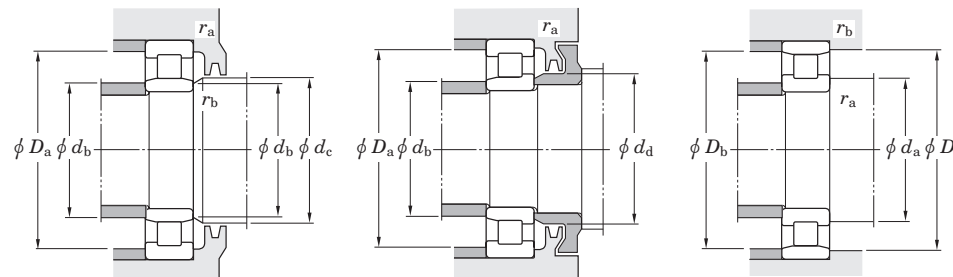
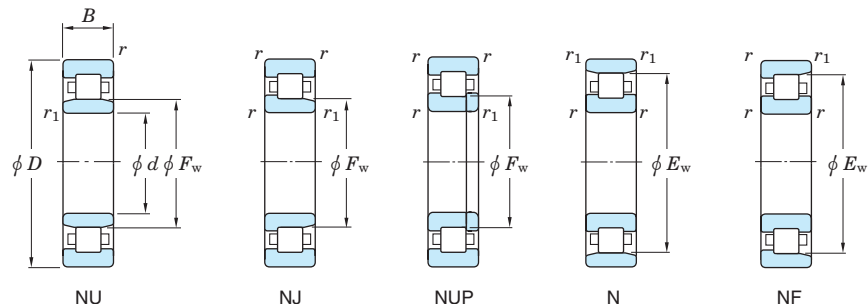

Boundary dimensions (mm)			Basic load ratings (kN)		Limiting speeds (min ⁻¹)		Bearing No.					Mounting dimensions (mm)								(Refer.)						
d	D	B	r min.	r1 min.	Fw	Ew	Cr	C0r	Grease lub.	Oil lub.	NU	NJ	NUP	N	NF	da min.	db min.	db max.	dc min.	da min.	Da max.	Db max.	ra min.	rb max.	Mass NU (kg)	
55	100	25	1.5	1.1	66	—	101	122	5 800	7 700	NU2211R	NJ2211R	NUP2211R	—	—	63	61.5	65	68	73	92	—	—	1.5	1	0.806
	100	33.3	1.5	1.5	66.5	—	95.5	118	5 100	7 700	NU3211	—	—	—	—	63	63	65	68	—	92	—	—	1.5	1	1.14
	120	29	2	2	70.5	104.5	111	111	5 100	6 800	NU311	NJ311	NUP311	N311	NF311	64	64	69	72	80	111	111	107	2	2	1.44
	120	29	2	2	70.5	—	137	143	5 100	6 700	NU311R	NJ311R	NUP311R	—	—	64	64	69	72	80	111	—	—	2	2	1.50
	120	43	2	2	70.5	—	148	162	4 500	6 800	NU2311	NJ2311	NUP2311	—	—	64	64	69	72	80	111	—	—	2	2	2.10
	120	43	2	2	70.5	—	201	233	4 500	6 700	NU2311R	NJ2311R	NUP2311R	—	—	64	64	69	72	80	111	—	—	2	2	2.25
	120	49.2	2	2	70.5	—	188	220	4 500	6 800	NU3311	—	—	—	—	64	64	69	72	—	111	—	—	2	2	2.81
	140	33	2.1	2.1	77.2	117.2	142	138	4 600	6 100	NU411	NJ411	NUP411	N411	NF411	66	66	76	79	87	129	129	119	2	2	2.51
60	95	18	1.1	1	69.5	—	42.1	50.0	7 000	8 300	NU1012	—	NUP1012	—	—	66.5	65	68	71	—	88.5	—	—	1	1	0.477
	110	22	1.5	1.5	73.5	97.5	71.9	79.9	5 800	7 000	NU212	NJ212	NUP212	N212	NF212	68	68	71	75	80	102	102	100	1.5	1.5	0.823
	110	22	1.5	1.5	72	—	97.7	107	5 800	6 900	NU212R	NJ212R	NUP212R	—	—	68	68	71	75	80	102	—	—	1.5	1.5	0.830
	110	28	1.5	1.5	73.5	—	101	123	5 200	7 000	NU2212	NJ2212	NUP2212	—	—	68	68	71	75	80	102	—	—	1.5	1.5	1.07
	110	28	1.5	1.5	72	—	131	157	5 200	6 900	NU2212R	NJ2212R	NUP2212R	—	—	68	68	71	75	80	102	—	—	1.5	1.5	1.09
	110	36.5	1.5	1.5	73.5	—	128	167	4 700	7 000	NU3212	—	—	—	—	68	68	71	75	—	102	—	—	1.5	1.5	1.52
	130	31	2.1	2.1	77	113	124	126	4 700	6 300	NU312	NJ312	NUP312	N312	NF312	71	71	75	79	86	119	119	116	2	2	1.83
	130	31	2.1	2.1	77	—	150	157	4 600	6 200	NU312R	NJ312R	NUP312R	—	—	71	71	75	79	86	119	—	—	2	2	1.87
	130	46	2.1	2.1	77	—	168	188	4 200	6 300	NU2312	NJ2312	NUP2312	—	—	71	71	75	79	86	119	—	—	2	2	2.69
	130	46	2.1	2.1	77	—	223	262	4 100	6 200	NU2312R	NJ2312R	NUP2312R	—	—	71	71	75	79	86	119	—	—	2	2	2.81
	130	54	2.1	2.1	77	—	220	265	4 200	6 300	NU3312	—	—	—	—	71	71	75	79	—	119	—	—	2	2	3.61
	150	35	2.1	2.1	83	127	178	184	4 200	5 700	NU412	NJ412	NUP412	N412	NF412	71	71	82	85	94	139	139	128	2	2	3.02
	65	100	18	1.1	1	74.5	—	43.3	52.9	6 600	7 800	NU1013	—	NUP1013	—	—	71.5	70	73	76	—	93.5	—	—	1	1
120		23	1.5	1.5	79.6	105.6	83.8	94.4	5 400	6 400	NU213	NJ213	NUP213	N213	NF213	73	73	77	81	87	112	112	108	1.5	1.5	1.05
120		23	1.5	1.5	78.5	—	108	119	5 300	6 400	NU213R	NJ213R	NUP213R	—	—	73	73	77	81	87	112	—	—	1.5	1.5	1.05
120		31	1.5	1.5	79.6	—	120	149	4 800	6 400	NU2213	NJ2213	NUP2213	—	—	73	73	77	81	87	112	—	—	1.5	1.5	1.43
120		31	1.5	1.5	78.5	—	149	181	4 800	6 400	NU2213R	NJ2213R	NUP2213R	—	—	73	73	77	81	87	112	—	—	1.5	1.5	1.45
120		38.1	1.5	1.5	79.6	—	148	197	4 300	6 400	NU3213	—	—	—	—	73	73	77	81	—	112	—	—	1.5	1.5	1.90
140		33	2.1	2.1	83.5	121.5	137	139	4 300	5 800	NU313	NJ313	NUP313	N313	NF313	76	76	81	85	93	129	129	125	2	2	2.24

[Remarks] 1) Standard cage types used for the above bearings are shown in Table 1 earlier in this section. Please note that basic load ratings and limiting speeds shown above indicate the value applicable to machined cage. Consult JTEKT about bearings with pressed cage, since they may be different from bearings with machined cage in values above.

2) Bearing numbers of NU and NJ type bearings with mounted thrust collar (refer to specification table shown after this specification table) are NUJ and NH.

Single-row cylindrical roller bearings

d (65) ~ (75) mm

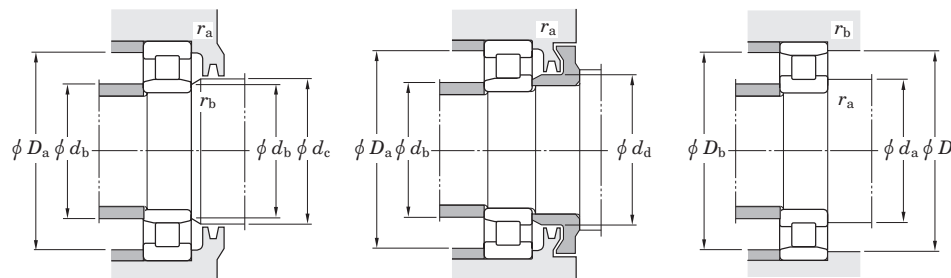
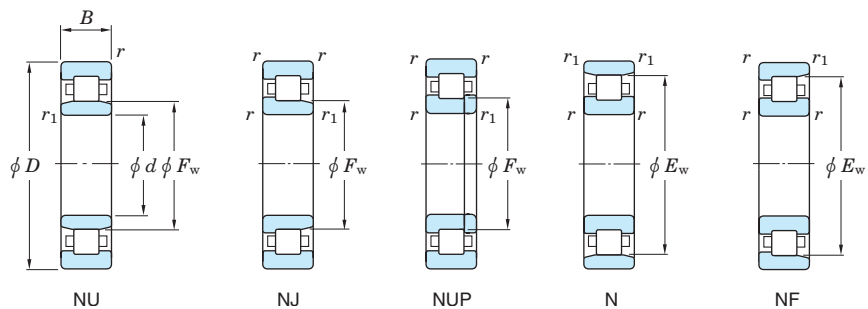

Boundary dimensions (mm)			Basic load ratings (kN)		Limiting speeds (min ⁻¹)		Bearing No.					Mounting dimensions (mm)								(Refer.)						
d	D	B	r min.	r1 min.	Fw	Ew	Cr	C0r	Grease lub.	Oil lub.	NU	NJ	NUP	N	NF	da min.	db min.	db max.	dc min.	da min.	Da max.	Db max.	rb min.	ra max.	rb max.	Mass NU (kg)
65	140	33	2.1	2.1	82.5	—	181	191	4 300	5 700	NU313R	NJ313R	NUP313R	—	—	76	76	81	85	93	129	—	—	2	2	2.31
	140	48	2.1	2.1	83.5	—	190	212	3 900	5 800	NU2313	NJ2313	NUP2313	—	—	76	76	81	85	93	129	—	—	2	2	3.25
	140	48	2.1	2.1	82.5	—	251	287	3 800	5 700	NU2313R	NJ2313R	NUP2313R	—	—	76	76	81	85	93	129	—	—	2	2	3.36
	140	58.7	2.1	2.1	83.5	—	241	294	3 900	5 800	NU3313	—	—	—	—	76	76	81	85	—	129	—	—	2	2	4.53
	160	37	2.1	2.1	89.3	135.3	198	203	4 000	5 300	NU413	NJ413	NUP413	N413	NF413	76	76	88	91	100	149	149	137	2	2	3.58
	70	110	20	1.1	1	80	—	57.9	70.4	6 100	7 200	NU1014	—	NUP1014	—	—	76.5	75	78	82	—	103.5	—	—	1	1
125	24	1.5	1.5	84.5	110.5	83.3	95.2	5 100	6 100	NU214	NJ214	NUP214	N214	NF214	78	78	82	86	92	117	117	114	1.5	1.5	1.15	
125	24	1.5	1.5	83.5	—	119	137	5 000	6 000	NU214R	NJ214R	NUP214R	—	—	78	78	82	86	92	117	—	—	1.5	1.5	1.16	
125	31	1.5	1.5	84.5	—	119	151	4 600	6 100	NU2214	NJ2214	NUP2214	—	—	78	78	82	86	92	117	—	—	1.5	1.5	1.52	
125	31	1.5	1.5	83.5	—	156	194	4 500	6 000	NU2214R	NJ2214R	NUP2214R	—	—	78	78	82	86	92	117	—	—	1.5	1.5	1.53	
125	39.7	1.5	1.5	84.5	—	147	198	4 100	6 100	NU3214	—	—	—	—	78	78	82	86	—	117	—	—	1.5	1.5	2.09	
150	35	2.1	2.1	90	130	162	168	4 000	5 400	NU314	NJ314	NUP314	N314	NF314	81	81	87	92	100	139	139	134	2	2	2.73	
150	35	2.1	2.1	89	—	205	222	4 000	5 300	NU314R	NJ314R	NUP314R	—	—	81	81	87	92	100	139	—	—	2	2	2.81	
150	51	2.1	2.1	90	—	224	262	3 600	5 400	NU2314	NJ2314	NUP2314	—	—	81	81	87	92	100	139	—	—	2	2	3.97	
150	51	2.1	2.1	89	—	275	323	3 600	5 300	NU2314R	NJ2314R	NUP2314R	—	—	81	81	87	92	100	139	—	—	2	2	4.08	
150	63.5	2.1	2.1	90	—	283	356	3 600	5 400	NU3314	—	—	—	—	81	81	87	92	—	139	—	—	2	2	5.62	
180	42	3	3	100	152	246	257	3 500	4 700	NU414	NJ414	NUP414	N414	NF414	83	83	99	102	112	167	167	153	2.5	2.5	5.26	
75	115	20	1.1	1	85	—	63.6	78.1	5 700	6 800	NU1015	—	NUP1015	—	—	81.5	80	83	87	—	108.5	—	—	1	1	0.735
130	25	1.5	1.5	88.5	116.5	101	118	4 800	5 800	NU215	NJ215	NUP215	N215	NF215	83	83	87	90	96	122	122	120	1.5	1.5	1.24	
130	25	1.5	1.5	88.5	—	130	156	4 800	5 700	NU215R	NJ215R	NUP215R	—	—	83	83	87	90	96	122	—	—	1.5	1.5	1.29	
130	31	1.5	1.5	88.5	—	135	172	4 300	5 800	NU2215	NJ2215	NUP2215	—	—	83	83	87	90	96	122	—	—	1.5	1.5	1.57	
130	31	1.5	1.5	88.5	—	162	207	4 300	5 700	NU2215R	NJ2215R	NUP2215R	—	—	83	83	87	90	96	122	—	—	1.5	1.5	1.61	
130	41.3	1.5	1.5	88.5	—	167	226	3 900	5 800	NU3215	—	—	—	—	83	83	87	90	—	122	—	—	1.5	1.5	2.28	
160	37	2.1	2.1	95.5	139.5	194	205	3 800	5 000	NU315	NJ315	NUP315	N315	NF315	86	86	93	97	106	149	149	143	2	2	3.24	
160	37	2.1	2.1	95	—	240	263	3 700	5 000	NU315R	NJ315R	NUP315R	—	—	86	86	93	97	106	149	—	—	2	2	3.37	
160	55	2.1	2.1	95.5	—	275	327	3 400	5 000	NU2315	NJ2315	NUP2315	—	—	86	86	93	97	106	149	—	—	2	2	4.84	
160	55	2.1	2.1	95	—	329	395	3 300	5 000	NU2315R	NJ2315R	NUP2315R	—	—	86	86	93	97	106	149	—	—	2	2	5.00	

[Remarks] 1) Standard cage types used for the above bearings are shown in Table 1 earlier in this section. Please note that basic load ratings and limiting speeds shown above indicate the value applicable to machined cage. Consult JTEKT about bearings with pressed cage, since they may be different from bearings with machined cage in values above.

2) Bearing numbers of NU and NJ type bearings with mounted thrust collar (refer to specification table shown after this specification table) are NUJ and NH.

Single-row cylindrical roller bearings

d (75) ~ (90) mm

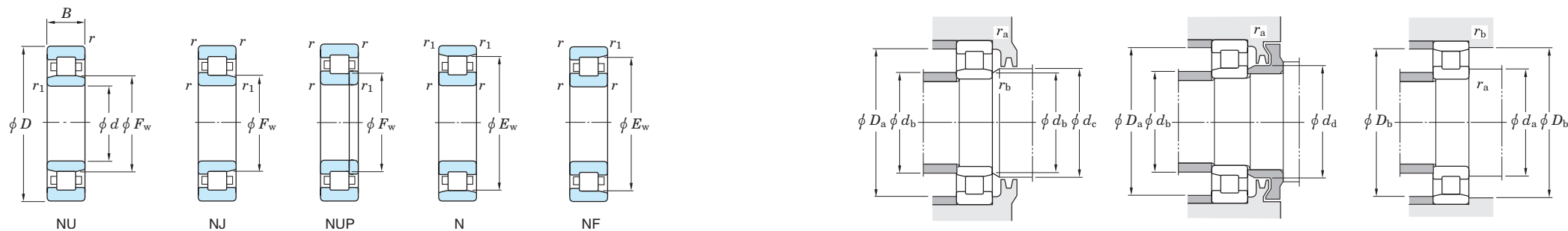

Boundary dimensions (mm)			Basic load ratings (kN)		Limiting speeds (min ⁻¹)		Bearing No.					Mounting dimensions (mm)								(Refer.)						
d	D	B	r min.	r1 min.	Fw	Ew	Cr	C0r	Grease lub.	Oil lub.	NU	NJ	NUP	N	NF	da min.	db min.	db max.	dc min.	da min.	Da max.	Db max.	ra min.	rb max.	Mass NU (kg)	
75	160	68.3	2.1	2.1	95.5	—	338	430	3 400	5 000	NU3315	—	—	—	—	86	86	93	97	—	149	—	—	2	2	6.86
	190	45	3	3	104.5	160.5	265	274	3 300	4 400	NU415	NJ415	NUP415	N415	NF415	88	88	103	107	118	177	177	162	2.5	2.5	6.25
80	125	22	1.1	1	91.5	—	69.3	86.4	5 300	6 300	NU1016	—	NUP1016	—	—	86.5	85	90	94	—	118.5	—	—	1	1	0.994
	140	26	2	2	95.3	125.3	106	122	4 500	5 400	NU216	NJ216	NUP216	N216	NF216	89	89	94	97	104	131	131	128	2	2	1.51
	140	26	2	2	95.3	—	139	167	4 400	5 300	NU216R	NJ216R	NUP216R	—	—	89	89	94	97	104	131	—	—	2	2	1.56
	140	33	2	2	95.3	—	148	186	4 000	5 400	NU2216	NJ2216	NUP2216	—	—	89	89	94	97	104	131	—	—	2	2	1.96
	140	33	2	2	95.3	—	186	243	4 000	5 300	NU2216R	NJ2216R	NUP2216R	—	—	89	89	94	97	104	131	—	—	2	2	2.03
	140	44.4	2	2	95.3	—	190	259	3 600	5 400	NU3216	—	—	—	—	89	89	94	97	—	131	—	—	2	2	2.87
	170	39	2.1	2.1	103	147	194	207	3 500	4 700	NU316	NJ316	NUP316	N316	NF316	91	91	99	105	114	159	159	151	2	2	3.92
	170	39	2.1	2.1	101	—	259	282	3 500	4 700	NU316R	NJ316R	NUP316R	—	—	91	91	99	105	114	159	—	—	2	2	4.00
	170	58	2.1	2.1	103	—	275	332	3 100	4 700	NU2316	NJ2316	NUP2316	—	—	91	91	99	105	114	159	—	—	2	2	5.83
	170	58	2.1	2.1	101	—	361	431	3 100	4 700	NU2316R	NJ2316R	NUP2316R	—	—	91	91	99	105	114	159	—	—	2	2	5.95
	170	68.3	2.1	2.1	103	—	338	436	3 100	4 700	NU3316	—	—	—	—	91	91	99	105	—	159	—	—	2	2	7.72
	200	48	3	3	110	170	302	315	3 100	4 200	NU416	NJ416	NUP416	N416	NF416	93	93	109	112	124	187	187	172	2.5	2.5	7.28
85	130	22	1.1	1	96.5	—	71.4	91.2	5 100	6 000	NU1017	—	NUP1017	—	—	91.5	90	95	99	—	123.5	—	—	1	1	1.04
	150	28	2	2	101.8	133.8	121	140	4 200	5 000	NU217	NJ217	NUP217	N217	NF217	94	94	99	104	110	141	141	137	2	2	1.90
	150	28	2	2	100.5	—	167	199	4 200	5 000	NU217R	NJ217R	NUP217R	—	—	94	94	99	104	110	141	—	—	2	2	1.94
	150	36	2	2	101.8	—	169	218	3 800	5 000	NU2217	NJ2217	NUP2217	—	—	94	94	99	104	110	141	—	—	2	2	2.50
	150	36	2	2	100.5	—	218	279	3 700	5 000	NU2217R	NJ2217R	NUP2217R	—	—	94	94	99	104	110	141	—	—	2	2	2.53
	150	49.2	2	2	101.8	—	215	296	3 300	5 000	NU3217	—	—	—	—	94	94	99	104	—	141	—	—	2	2	3.67
	180	41	3	3	108	156	225	247	3 300	4 500	NU317	NJ317	NUP317	N317	NF317	98	98	106	110	119	167	167	160	2.5	2.5	4.52
	180	41	3	3	108	—	291	330	3 300	4 400	NU317R	NJ317R	NUP317R	—	—	98	98	106	110	119	167	—	—	2.5	2.5	4.80
	180	60	3	3	108	—	315	382	3 000	4 500	NU2317	NJ2317	NUP2317	—	—	98	98	106	110	119	167	—	—	2.5	2.5	6.62
	180	60	3	3	108	—	394	485	2 900	4 400	NU2317R	NJ2317R	NUP2317R	—	—	98	98	106	110	119	167	—	—	2.5	2.5	6.98
	180	73	3	3	108	—	399	517	3 000	4 500	NU3317	—	—	—	—	98	98	106	110	—	167	—	—	2.5	2.5	9.23
	210	52	4	4	113	177	340	350	3 000	4 000	NU417	NJ417	NUP417	N417	NF417	101	101	111	115	128	194	194	179	3	3	8.68
90	140	24	1.5	1.1	103	—	84.7	109	4 700	5 600	NU1018	—	NUP1018	—	—	98	96.5	101	106	—	132	—	—	1.5	1	1.34

[Remarks] 1) Standard cage types used for the above bearings are shown in Table 1 earlier in this section. Please note that basic load ratings and limiting speeds shown above indicate the value applicable to machined cage. Consult JTEKT about bearings with pressed cage, since they may be different from bearings with machined cage in values above.

2) Bearing numbers of NU and NJ type bearings with mounted thrust collar (refer to specification table shown after this specification table) are NUJ and NH.

Single-row cylindrical roller bearings

d (90) ~ (100) mm

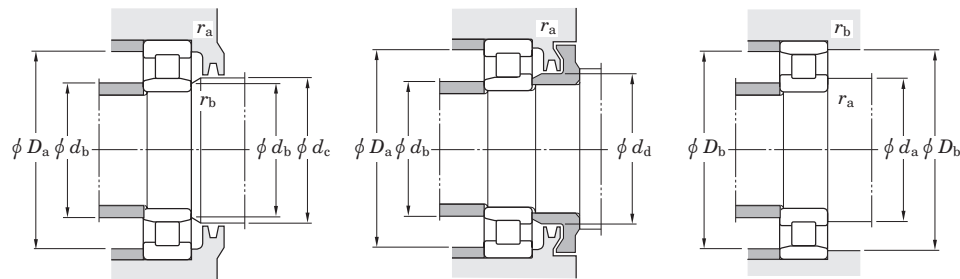
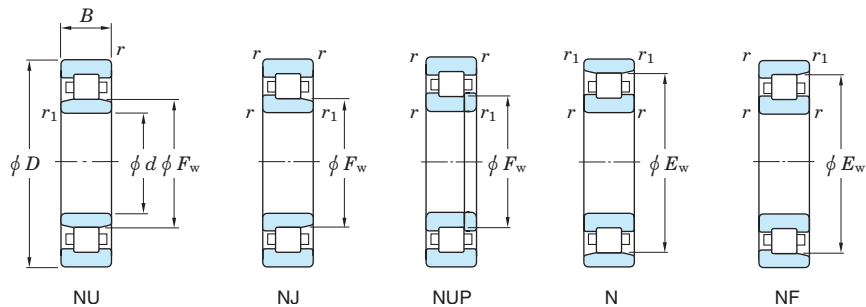

d	Boundary dimensions (mm)						Basic load ratings (kN)		Limiting speeds (min ⁻¹)		Bearing No.					Mounting dimensions (mm)								Mass NU (kg)			
	D	B	r min.	r_1 min.	F_w	E_w	C_r	C_{0r}	Grease lub.	Oil lub.	NU	NJ	NUP	N	NF	d_a min.	d_b min. max.	d_c min.	d_a min.	D_a max.	D_b max.	r_a min.	r_b max.				
90	160	30	2	2	107	143	152	178	3 900	4 700	NU218	NJ218	NUP218	N218	NF218	99	99	105	109	116	151	151	146	2	2	2.28	
	160	30	2	2	107	—	182	217	3 900	4 700	NU218R	NJ218R	NUP218R	—	—	99	99	105	109	116	151	—	—	2	2	2.38	
	160	40	2	2	107	—	207	265	3 500	4 700	NU2218	NJ2218	NUP2218	—	—	99	99	105	109	116	151	—	—	2	2	3.10	
	160	40	2	2	107	—	242	314	3 500	4 700	NU2218R	NJ2218R	NUP2218R	—	—	99	99	105	109	116	151	—	—	2	2	3.21	
	160	52.4	2	2	107	—	270	373	3 100	4 700	NU3218	—	—	—	—	99	99	105	109	—	151	—	—	2	2	4.49	
	190	43	3	3	115	165	243	265	3 100	4 200	NU318	NJ318	NUP318	N318	NF318	103	103	111	117	127	177	177	169	2.5	2.5	5.38	
	190	43	3	3	113.5	—	316	355	3 100	4 100	NU318R	NJ318R	NUP318R	—	—	103	103	111	117	127	177	—	—	2.5	2.5	5.47	
	190	64	3	3	115	—	329	395	2 800	4 200	NU2318	NJ2318	NUP2318	—	—	103	103	111	117	127	177	—	—	2.5	2.5	7.90	
	190	64	3	3	113.5	—	437	534	2 800	4 100	NU2318R	NJ2318R	NUP2318R	—	—	103	103	111	117	127	177	—	—	2.5	2.5	8.12	
	190	73	3	3	115	—	428	559	2 800	4 200	NU3318	—	—	—	—	103	103	111	117	—	177	—	—	2.5	2.5	10.3	
	225	54	4	4	123.5	191.5	374	400	2 800	3 700	NU418	NJ418	NUP418	N418	NF418	106	106	122	125	139	209	209	194	3	3	10.3	
	95	145	24	1.5	1.1	108	—	87.2	115	4 500	5 300	NU1019	—	NUP1019	—	—	103	101.5	106	111	—	137	—	—	1.5	1	1.40
		170	32	2.1	2.1	113.5	151.5	165	195	3 700	4 400	NU219	NJ219	NUP219	N219	NF219	106	106	111	116	123	159	159	155	2	2	2.80
		170	32	2.1	2.1	112.5	—	221	265	3 700	4 400	NU219R	NJ219R	NUP219R	—	—	106	106	111	116	123	159	—	—	2	2	2.92
170		43	2.1	2.1	113.5	—	230	298	3 300	4 400	NU2219	NJ2219	NUP2219	—	—	106	106	111	116	123	159	—	—	2	2	3.85	
170		43	2.1	2.1	112.5	—	287	371	3 300	4 400	NU2219R	NJ2219R	NUP2219R	—	—	106	106	111	116	123	159	—	—	2	2	3.93	
170		55.6	2.1	2.1	113.5	—	297	412	3 000	4 400	NU3219	—	—	—	—	106	106	111	116	—	159	—	—	2	2	5.42	
200		45	3	3	121.5	173.5	277	311	3 000	4 000	NU319	NJ319	NUP319	N319	NF319	108	108	119	124	134	187	187	178	2.5	2.5	6.20	
200		45	3	3	121.5	—	334	387	2 900	3 900	NU319R	NJ319R	NUP319R	—	—	108	108	119	124	134	187	—	—	2.5	2.5	6.42	
200		67	3	3	121.5	—	394	496	2 600	4 000	NU2319	NJ2319	NUP2319	—	—	108	108	119	124	134	187	—	—	2.5	2.5	9.39	
200		77.8	3	3	121.5	—	487	654	2 600	4 000	NU3319	—	—	—	—	108	108	119	124	—	187	—	—	2.5	2.5	12.1	
240		55	4	4	133.5	201.5	410	444	2 600	3 400	NU419	NJ419	NUP419	N419	NF419	111	111	132	136	149	224	224	204	3	3	13.6	
100		150	24	1.5	1.1	113	—	91.0	120	4 300	5 100	NU1020	—	NUP1020	—	—	108	106.5	111	116	—	142	—	—	1.5	1	1.46
		180	34	2.1	2.1	120	160	183	217	3 500	4 200	NU220	NJ220	NUP220	N220	NF220	111	111	117	122	130	169	169	164	2	2	3.38
		180	34	2.1	2.1	119	—	250	306	3 500	4 200	NU220R	NJ220R	NUP220R	—	—	111	111	117	122	130	169	—	—	2	2	3.52
	180	46	2.1	2.1	120	—	259	338	3 100	4 200	NU2220	NJ2220	NUP2220	—	—	111	111	117	122	130	169	—	—	2	2	4.67	
	180	46	2.1	2.1	119	—	334	444	3 100	4 200	NU2220R	NJ2220R	NUP2220R	—	—	111	111	117	122	130	169	—	—	2	2	4.82	

[Remarks] 1) Standard cage types used for the above bearings are shown in Table 1 earlier in this section. Please note that basic load ratings and limiting speeds shown above indicate the value applicable to machined cage. Consult JTEKT about bearings with pressed cage, since they may be different from bearings with machined cage in values above.

2) Bearing numbers of NU and NJ type bearings with mounted thrust collar (refer to specification table shown after this specification table) are NUJ and NH.

Single-row cylindrical roller bearings

d (100) ~ 110 mm

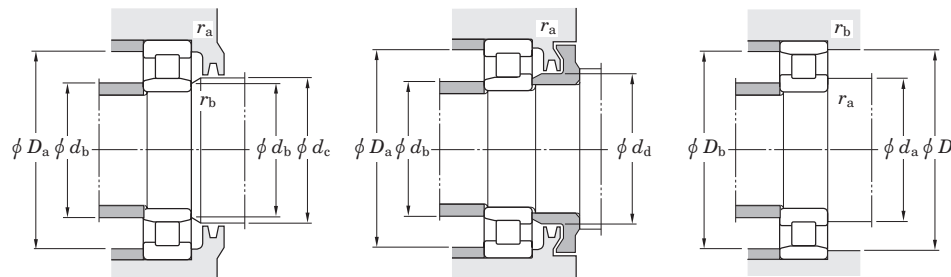
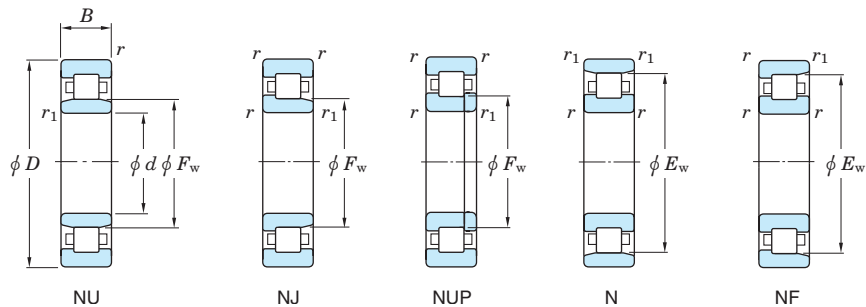

Boundary dimensions (mm)								Basic load ratings (kN)		Limiting speeds (min ⁻¹)		Bearing No.					Mounting dimensions (mm)								(Refer.)	
<i>d</i>	<i>D</i>	<i>B</i>	<i>r</i> min.	<i>r</i> ₁ min.	<i>F</i> _w	<i>E</i> _w	<i>C</i> _r	<i>C</i> _{0r}	Grease lub.	Oil lub.	NU	NJ	NUP	N	NF	<i>d</i> _a min.	<i>d</i> _b min.	<i>d</i> _b max.	<i>d</i> _c min.	<i>d</i> _a min.	<i>D</i> _a max.	<i>D</i> _b max.	<i>r</i> _a min.	<i>r</i> _b max.	Mass NU (kg)	
100	180	60.3	2.1	2.1	120	—	327	459	2 800	4 200	NU3220	—	—	—	—	111	111	117	122	—	169	—	—	2	2	6.62
	215	47	3	3	129.5	185.5	323	337	2 800	3 700	NU320	NJ320	NUP320	N320	NF320	113	113	125	132	143	202	202	190	2.5	2.5	7.70
	215	47	3	3	127.5	—	379	424	2 700	3 600	NU320R	NJ320R	NUP320R	—	—	113	113	125	132	143	202	—	—	2.5	2.5	7.75
	215	73	3	3	129.5	—	464	548	2 500	3 700	NU2320	NJ2320	NUP2320	—	—	113	113	125	132	143	202	—	—	2.5	2.5	11.9
	215	73	3	3	127.5	—	570	717	2 400	3 600	NU2320R	NJ2320R	NUP2320R	—	—	113	113	125	132	143	202	—	—	2.5	2.5	12.1
	215	82.6	3	3	129.5	—	530	706	2 500	3 700	NU3320	—	—	—	—	113	113	125	132	—	202	—	—	2.5	2.5	15.0
	250	58	4	4	139	211	458	498	2 500	3 300	NU420	NJ420	NUP420	N420	NF420	116	116	137	141	156	234	234	213	3	3	14.0
105	160	26	2	1.1	119.5	—	108	149	4 100	4 800	NU1021	—	NUP1021	—	—	114	111.5	118	122	—	151	—	—	2	1	1.85
	190	36	2.1	2.1	126.8	168.8	201	241	3 300	3 900	NU221	NJ221	NUP221	N221	NF221	116	116	124	129	137	179	179	173	2	2	4.00
	190	65.1	2.1	2.1	126.8	—	344	482	2 600	3 900	NU3221	—	—	—	—	116	116	124	129	—	179	—	—	2	2	8.00
	225	49	3	3	135	195	366	417	2 600	3 500	NU321	NJ321	NUP321	N321	NF321	118	118	132	137	149	212	212	199	2.5	2.5	8.76
	225	77	3	3	135	—	568	750	2 300	3 500	NU2321	—	NUP2321	—	—	118	118	131	138	—	212	—	—	2.5	2.5	15.6
	225	87.3	3	3	135	—	638	871	2 300	3 500	NU3321	—	—	—	—	118	118	132	137	—	212	—	—	2.5	2.5	17.4
	260	60	4	4	144.5	220.5	471	510	2 400	3 100	NU421	NJ421	NUP421	N421	NF421	121	121	143	147	162	244	244	223	3	3	19.1
110	170	28	2	1.1	125	—	134	171	3 800	4 500	NU1022	—	NUP1022	—	—	119	116.5	124	128	—	161	—	—	2	1	2.31
	200	38	2.1	2.1	132.5	178.5	241	290	3 100	3 700	NU222	NJ222	NUP222	N222	NF222	121	121	130	135	144	189	189	182	2	2	4.65
	200	38	2.1	2.1	132.5	—	293	365	3 100	3 700	NU222R	NJ222R	NUP222R	—	—	121	121	130	135	144	189	—	—	2	2	4.90
	200	53	2.1	2.1	132.5	—	334	442	2 800	3 700	NU2222	NJ2222	NUP2222	—	—	121	121	130	135	144	189	—	—	2	2	6.93
	200	53	2.1	2.1	132.5	—	384	517	2 800	3 700	NU2222R	NJ2222R	NUP2222R	—	—	121	121	130	135	144	189	—	—	2	2	6.93
	200	69.8	2.1	2.1	132.5	—	427	607	2 500	3 700	NU3222	—	—	—	—	121	121	130	135	—	189	—	—	2	2	9.55
	240	50	3	3	143	207	411	467	2 500	3 300	NU322	NJ322	NUP322	N322	NF322	123	123	140	145	158	227	227	211	2.5	2.5	10.4
	240	50	3	3	143	—	451	525	2 400	3 200	NU322R	NJ322R	NUP322R	—	—	123	123	140	145	158	227	—	—	2.5	2.5	10.7
	240	80	3	3	143	—	604	789	2 200	3 300	NU2322	NJ2322	NUP2322	—	—	123	123	140	145	158	227	—	—	2.5	2.5	18.8
	240	80	3	3	143	—	680	880	2 200	3 200	NU2322R	NJ2322R	NUP2322R	—	—	123	123	140	145	158	227	—	—	2.5	2.5	18.8
	240	92.1	3	3	143	—	678	918	2 200	3 300	NU3322	—	—	—	—	123	123	140	145	—	227	—	—	2.5	2.5	21.1
	280	65	4	4	155	235	550	621	2 200	2 900	NU422	NJ422	NUP422	N422	NF422	126	126	153	157	173	264	264	237	3	3	19.9

[Remarks] 1) Standard cage types used for the above bearings are shown in Table 1 earlier in this section. Please note that basic load ratings and limiting speeds shown above indicate the value applicable to machined cage. Consult JTEKT about bearings with pressed cage, since they may be different from bearings with machined cage in values above.

2) Bearing numbers of NU and NJ type bearings with mounted thrust collar (refer to specification table shown after this specification table) are NUJ and NH.

Single-row cylindrical roller bearings

d 120 ~ (140) mm

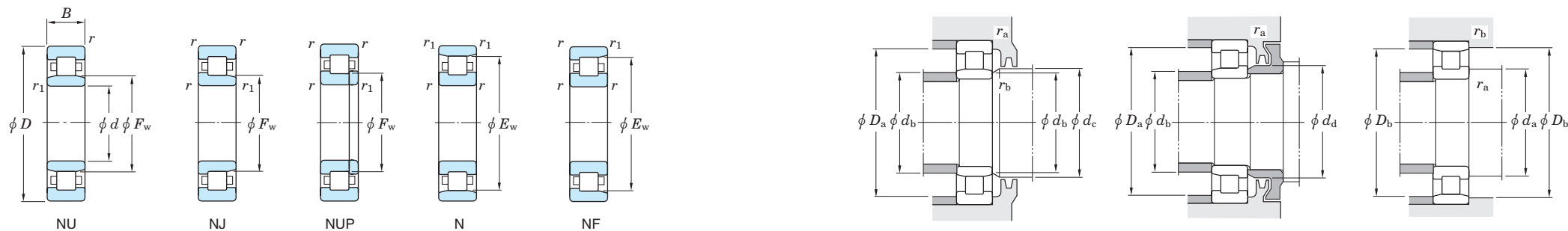

d	Boundary dimensions (mm)						Basic load ratings (kN)		Limiting speeds (min ⁻¹)		Bearing No.					Mounting dimensions (mm)								Mass NU (kg)		
	D	B	r min.	r1 min.	Fw	Ew	Cr	C0r	Grease lub.	Oil lub.	NU	NJ	NUP	N	NF	da min.	db min.	db max.	dc min.	da min.	Da max.	Db max.	ra min.		rb max.	
120	180	28	2	1.1	135	—	137	181	3 500	4 200	NU1024	—	NUP1024	—	—	129	126.5	134	138	—	171	—	—	2	1	2.47
	215	40	2.1	2.1	143.5	191.5	260	318	2 900	3 400	NU224	NJ224	NUP224	N224	NF224	131	131	141	146	156	204	204	196	2	2	5.65
	215	40	2.1	2.1	143.5	—	336	421	2 800	3 400	NU224R	NJ224R	NUP224R	—	—	131	131	141	146	156	204	—	—	2	2	5.85
	215	58	2.1	2.1	143.5	—	367	492	2 600	3 400	NU2224	NJ2224	NUP2224	—	—	131	131	141	146	156	204	—	—	2	2	8.56
	215	58	2.1	2.1	143.5	—	452	619	2 600	3 400	NU2224R	NJ2224R	NUP2224R	—	—	131	131	141	146	156	204	—	—	2	2	8.56
	215	76	2.1	2.1	143.5	—	477	695	2 300	3 400	NU3224	—	—	—	—	131	131	141	146	—	204	—	—	2	2	11.9
	260	55	3	3	154	226	485	551	2 200	3 000	NU324	NJ324	NUP324	N324	NF324	133	133	151	156	171	247	247	230	2.5	2.5	13.1
	260	55	3	3	154	—	528	610	2 200	3 000	NU324R	NJ324R	NUP324R	—	—	133	133	151	156	171	247	—	—	2.5	2.5	13.4
	260	86	3	3	154	—	708	918	2 000	3 000	NU2324	NJ2324	NUP2324	—	—	133	133	151	156	171	247	—	—	2.5	2.5	23.1
	260	86	3	3	154	—	793	1 030	2 000	3 000	NU2324R	NJ2324R	NUP2324R	—	—	133	133	151	156	172	247	—	—	2.5	2.5	23.1
	260	106	3	3	154	—	826	1 120	2 000	3 000	NU3324	—	—	—	—	133	133	151	156	—	247	—	—	2.5	2.5	28.3
	310	72	5	5	170	260	690	770	1 900	2 600	NU424	NJ424	NUP424	N424	NF424	140	140	168	172	190	290	290	262	4	4	28.0
130	200	33	2	1.1	148	—	171	238	3 200	3 800	NU1026	—	NUP1026	—	—	139	136.5	146	151	—	191	—	—	2	1	3.77
	230	40	3	3	156	204	282	362	2 700	3 200	NU226	NJ226	NUP226	N226	NF226	143	143	151	158	168	217	217	208	2.5	2.5	6.49
	230	40	3	3	153.5	—	364	453	2 600	3 200	NU226R	NJ226R	NUP226R	—	—	143	143	151	158	168	217	—	—	2.5	2.5	6.60
	230	64	3	3	156	—	395	560	2 400	3 200	NU2226	NJ2226	NUP2226	—	—	143	143	151	158	168	217	—	—	2.5	2.5	11.2
	230	64	3	3	153.5	—	530	737	2 400	3 200	NU2226R	NJ2226R	NUP2226R	—	—	143	143	151	158	168	217	—	—	2.5	2.5	11.2
	230	80	3	3	156	—	550	857	2 100	3 200	NU3226	—	—	—	—	143	143	151	158	—	217	—	—	2.5	2.5	14.1
	280	58	4	4	167	243	564	667	2 100	2 700	NU326	NJ326	NUP326	N326	NF326	146	146	164	169	184	264	264	247	3	3	16.4
	280	58	4	4	167	—	616	736	2 000	2 700	NU326R	NJ326R	NUP326R	—	—	146	146	164	169	184	264	—	—	3	3	16.7
	280	93	4	4	167	—	838	1 130	1 800	2 700	NU2326	NJ2326	NUP2326	—	—	146	146	164	169	184	264	—	—	3	3	29.1
	280	93	4	4	167	—	920	1 230	1 800	2 700	NU2326R	NJ2326R	NUP2326R	—	—	146	146	164	169	186	264	—	—	3	3	29.1
	280	112	4	4	167	—	936	1 290	1 800	2 700	NU3326	—	—	—	—	146	146	164	169	—	264	—	—	3	3	34.6
	340	78	5	5	185	285	771	876	1 800	2 300	NU426	NJ426	NUP426	N426	NF426	150	150	183	187	208	320	320	287	4	4	36.1
140	210	33	2	1.1	158	—	175	250	3 000	3 600	NU1028	—	NUP1028	—	—	149	146.5	156	161	—	201	—	—	2	1	4.00
	250	42	3	3	169	221	324	421	2 400	2 900	NU228	NJ228	NUP228	N228	NF228	153	153	166	171	182	237	237	228	2.5	2.5	8.27
	250	42	3	3	169	—	392	514	2 400	2 900	NU228R	NJ228R	NUP228R	—	—	153	153	166	171	182	237	—	—	2.5	2.5	8.50

[Remarks] 1) Standard cage types used for the above bearings are shown in Table 1 earlier in this section. Please note that basic load ratings and limiting speeds shown above indicate the value applicable to machined cage. Consult JTEKT about bearings with pressed cage, since they may be different from bearings with machined cage in values above.

2) Bearing numbers of NU and NJ type bearings with mounted thrust collar (refer to specification table shown after this specification table) are NUJ and NH.

Single-row cylindrical roller bearings

d (140) ~ (160) mm

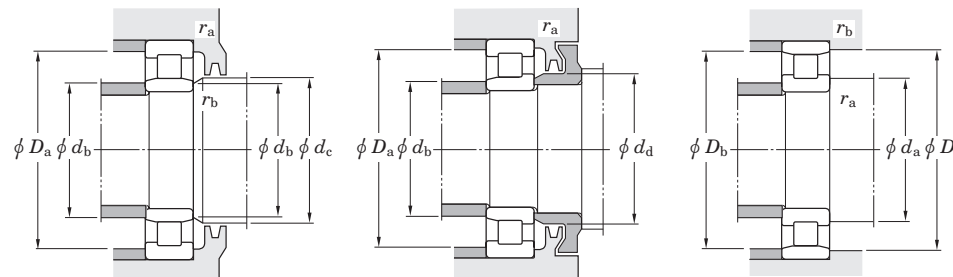
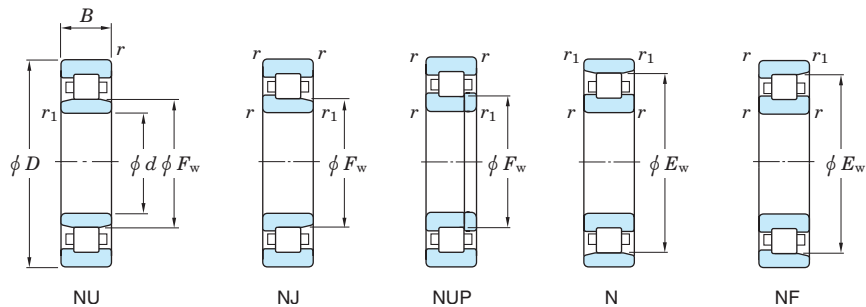

d	Boundary dimensions (mm)						Basic load ratings (kN)		Limiting speeds (min ⁻¹)		Bearing No.					Mounting dimensions (mm)								Mass NU (kg)		
	D	B	r _{min.}	r _{1 min.}	F _w	E _w	C _r	C _{0r}	Grease lub.	Oil lub.	NU	NJ	NUP	N	NF	d _{a min.}	d _{b min.}	d _{b max.}	d _{c min.}	d _{a min.}	D _{a max.}	D _{b max.}	r _{a min.}		r _{b min.}	r _{a max.}
140	250	68	3	3	169	—	465	671	2 200	2 900	NU2228	NJ2228	NUP2228	—	—	153	153	166	171	182	237	—	—	2.5	2.5	14.3
	250	68	3	3	169	—	572	835	2 200	2 900	NU2228R	NJ2228R	NUP2228R	—	—	153	153	166	171	182	237	—	—	2.5	2.5	14.3
	250	88	3	3	169	—	604	939	1 900	2 900	NU3228	—	—	—	—	153	153	166	171	—	237	—	—	2.5	2.5	18.5
	300	62	4	4	180	260	623	746	1 900	2 500	NU328	NJ328	NUP328	N328	NF328	156	156	176	182	198	284	284	264	3	3	21.8
	300	62	4	4	180	—	663	797	1 900	2 500	NU328R	NJ328R	NUP328R	—	—	156	156	176	182	198	284	—	—	3	3	21.8
	300	102	4	4	180	—	920	1 250	1 700	2 500	NU2328	NJ2328	NUP2328	—	—	156	156	176	182	198	284	—	—	3	3	36.8
	300	102	4	4	180	—	1 020	1 380	1 700	2 500	NU2328R	NJ2328R	NUP2328R	—	—	156	156	176	182	200	284	—	—	3	3	36.8
	300	118	4	4	180	—	1 090	1 550	1 700	2 500	NU3328	—	—	—	—	156	156	176	182	—	284	—	—	3	3	41.5
	360	82	5	5	198	302	874	1 020	1 600	2 200	NU428	NJ428	NUP428	N428	NF428	160	160	195	200	222	340	340	304	4	4	46.8
	150	225	35	2.1	1.5	169.5	—	201	281	2 800	3 300	NU1030	—	NUP1030	—	—	161	158	167	173	—	214	—	—	2	1.5
270		45	3	3	182	238	374	492	2 200	2 700	NU230	NJ230	NUP230	N230	NF230	163	163	179	184	196	257	257	245	2.5	2.5	10.3
270		45	3	3	182	—	448	594	2 200	2 600	NU230R	NJ230R	NUP230R	—	—	163	163	179	184	196	257	—	—	2.5	2.5	10.7
270		73	3	3	182	—	545	800	2 000	2 700	NU2230	NJ2230	NUP2230	—	—	163	163	179	184	196	257	—	—	2.5	2.5	18.7
270		73	3	3	182	—	662	982	2 000	2 600	NU2230R	NJ2230R	NUP2230R	—	—	163	163	179	184	196	257	—	—	2.5	2.5	18.7
270		96	3	3	182	—	749	1 200	1 800	2 700	NU3230	—	—	—	—	163	163	179	184	—	257	—	—	2.5	2.5	23.7
320		65	4	4	193	277	663	807	1 800	2 300	NU330	NJ330	NUP330	N330	NF330	166	166	190	195	213	304	304	281	3	3	26.4
320		65	4	4	193	—	757	922	1 700	2 300	NU330R	NJ330R	NUP330R	—	—	166	166	190	195	213	304	—	—	3	3	27.0
320		108	4	4	193	—	1 020	1 400	1 600	2 300	NU2330	NJ2330	NUP2330	—	—	166	166	190	195	213	304	—	—	3	3	44.7
320		108	4	4	193	—	1 180	1 600	1 500	2 300	NU2330R	NJ2330R	NUP2330R	—	—	166	166	190	195	213	304	—	—	3	3	44.7
320		128	4	4	193	—	1 290	1 890	1 600	2 300	NU3330	—	—	—	—	166	166	190	195	—	304	—	—	3	3	51.4
380		85	5	5	213	317	930	1 120	1 500	2 000	NU430	NJ430	NUP430	N430	NF430	170	170	210	216	237	360	360	319	4	4	53.3
160		240	38	2.1	1.5	180	—	236	330	2 600	3 000	NU1032	—	NUP1032	—	—	171	168	178	184	—	229	—	—	2	1.5
	290	48	3	3	195	255	427	568	2 100	2 500	NU232	NJ232	NUP232	N232	NF232	173	173	192	197	210	277	277	262	2.5	2.5	14.4
	290	48	3	3	195	—	498	666	2 000	2 400	NU232R	NJ232R	NUP232R	—	—	173	173	192	197	210	277	—	—	2.5	2.5	14.8
	290	80	3	3	195	—	631	939	1 800	2 500	NU2232	NJ2232	NUP2232	—	—	173	173	192	197	210	277	—	—	2.5	2.5	23.6
	290	80	3	3	193	—	809	1 190	1 800	2 400	NU2232R	NJ2232R	NUP2232R	—	—	173	173	192	197	210	277	—	—	2.5	2.5	23.6
	290	104	3	3	195	—	857	1 390	1 600	2 500	NU3232	—	—	—	—	173	173	192	197	—	277	—	—	2.5	2.5	29.8

[Remarks] 1) Standard cage types used for the above bearings are shown in Table 1 earlier in this section. Please note that basic load ratings and limiting speeds shown above indicate the value applicable to machined cage. Consult JTEKT about bearings with pressed cage, since they may be different from bearings with machined cage in values above.

2) Bearing numbers of NU and NJ type bearings with mounted thrust collar (refer to specification table shown after this specification table) are NUJ and NH.

Single-row cylindrical roller bearings

d (160) ~ (190) mm

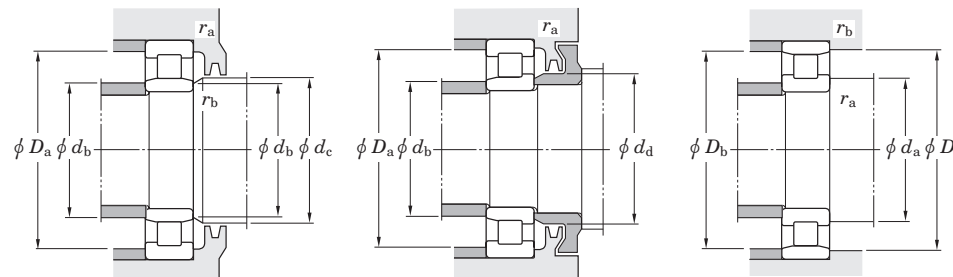
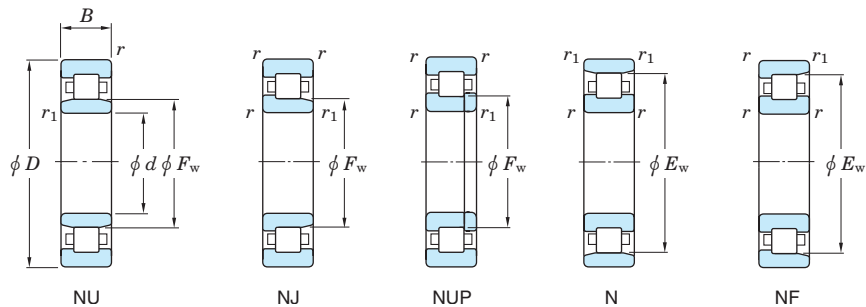

Boundary dimensions (mm)			Basic load ratings (kN)		Limiting speeds (min ⁻¹)		Bearing No.					Mounting dimensions (mm)								(Refer.)						
d	D	B	r min.	r1 min.	Fw	Ew	Cr	C0r	Grease lub.	Oil lub.	NU	NJ	NUP	N	NF	da min.	db min.	db max.	dc min.	da min.	Da max.	Db max.	ra min.	rb max.	Mass NU (kg)	
160	340	68	4	4	208	292	698	876	1 600	2 200	NU332	NJ332	NUP332	N332	NF332	176	176	200	211	228	324	324	296	3	3	31.7
	340	68	4	4	204	—	857	1 050	1 600	2 100	NU332R	NJ332R	NUP332R	—	—	176	176	200	211	228	324	—	—	3	3	32.0
	340	114	4	4	208	—	1 070	1 520	1 400	2 200	NU2332	NJ2332	NUP2332	—	—	176	176	200	211	228	324	—	—	3	3	53.1
	340	114	4	4	204	—	1 310	1 820	1 400	2 100	NU2332R	NJ2332R	NUP2332R	—	—	176	176	200	211	228	324	—	—	3	3	53.1
	340	136	4	4	208	—	1 270	1 890	1 400	2 200	NU3332	—	—	—	—	176	176	200	211	—	324	—	—	3	3	61.5
170	260	42	2.1	2.1	193	—	276	400	2 400	2 800	NU1034	—	NUP1034	—	—	181	181	190	197	—	249	—	—	2	2	7.90
	310	52	4	4	208	272	475	637	1 900	2 300	NU234	NJ234	NUP234	N234	NF234	186	186	204	211	223	294	294	280	3	3	18.4
	310	52	4	4	207	—	603	802	1 900	2 200	NU234R	NJ234R	NUP234R	—	—	186	186	204	211	223	294	—	—	3	3	18.6
	310	86	4	4	208	—	715	1 080	1 700	2 300	NU2234	NJ2234	NUP2234	—	—	186	186	204	211	223	294	—	—	3	3	29.2
	310	86	4	4	205	—	967	1 410	1 700	2 200	NU2234R	NJ2234R	NUP2234R	—	—	186	186	204	211	223	294	—	—	3	3	29.2
	310	110	4	4	208	—	964	1 580	1 500	2 300	NU3234	—	—	—	—	186	186	204	211	—	294	—	—	3	3	36.2
	360	72	4	4	220	310	809	1 010	1 500	2 000	NU334	NJ334	NUP334	N334	NF334	186	186	216	223	241	344	344	314	3	3	38.6
	360	120	4	4	220	—	1 220	1 750	1 300	2 000	NU2334	NJ2334	NUP2334	—	—	186	186	216	223	241	344	—	—	3	3	62.6
	360	140	4	4	220	—	1 420	2 120	1 300	2 000	NU3334	—	—	—	—	186	186	216	223	—	344	—	—	3	3	70.8
180	280	46	2.1	2.1	205	—	356	503	2 200	2 600	NU1036	—	NUP1036	—	—	191	191	203	209	—	269	—	—	2	2	10.5
	320	52	4	4	218	282	492	677	1 800	2 200	NU236	NJ236	NUP236	N236	NF236	196	196	214	221	233	304	304	290	3	3	19.3
	320	52	4	4	217	—	626	852	1 800	2 100	NU236R	NJ236R	NUP236R	—	—	196	196	214	221	233	304	—	—	3	3	19.3
	320	86	4	4	218	—	741	1 140	1 600	2 200	NU2236	NJ2236	NUP2236	—	—	196	196	214	221	233	304	—	—	3	3	30.4
	320	86	4	4	215	—	1 010	1 510	1 600	2 100	NU2236R	NJ2236R	NUP2236R	—	—	196	196	214	221	233	304	—	—	3	3	30.4
	320	112	4	4	218	—	999	1 680	1 400	2 200	NU3236	—	—	—	—	196	196	214	221	—	304	—	—	3	3	38.4
	380	75	4	4	232	328	917	1 150	1 400	1 900	NU336	NJ336	NUP336	N336	NF336	196	196	227	235	255	364	364	332	3	3	42.6
	380	126	4	4	232	—	1 350	1 940	1 300	1 900	NU2336	NJ2336	NUP2336	—	—	196	196	227	235	255	364	—	—	3	3	73.0
	380	150	4	4	232	—	1 660	2 520	1 300	1 900	NU3336	—	—	—	—	196	196	227	235	—	364	—	—	3	3	84.4
190	290	46	2.1	2.1	215	—	366	530	2 100	2 500	NU1038	—	NUP1038	—	—	201	201	213	219	—	279	—	—	2	2	10.9
	340	55	4	4	231	299	554	768	1 700	2 000	NU238	NJ238	NUP238	N238	NF238	206	206	227	234	247	324	324	310	3	3	23.2
	340	55	4	4	230	—	694	954	1 700	2 000	NU238R	NJ238R	NUP238R	—	—	206	206	227	234	247	324	—	—	3	3	23.3
	340	92	4	4	231	—	828	1 290	1 500	2 000	NU2238	NJ2238	NUP2238	—	—	206	206	227	234	247	324	—	—	3	3	37.0

[Remarks] 1) Standard cage types used for the above bearings are shown in Table 1 earlier in this section. Please note that basic load ratings and limiting speeds shown above indicate the value applicable to machined cage. Consult JTEKT about bearings with pressed cage, since they may be different from bearings with machined cage in values above.

2) Bearing numbers of NU and NJ type bearings with mounted thrust collar (refer to specification table shown after this specification table) are NUJ and NH.

Single-row cylindrical roller bearings

d (190) ~ (240) mm

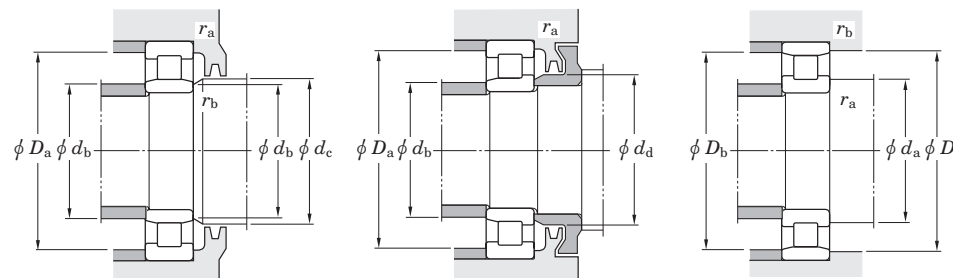
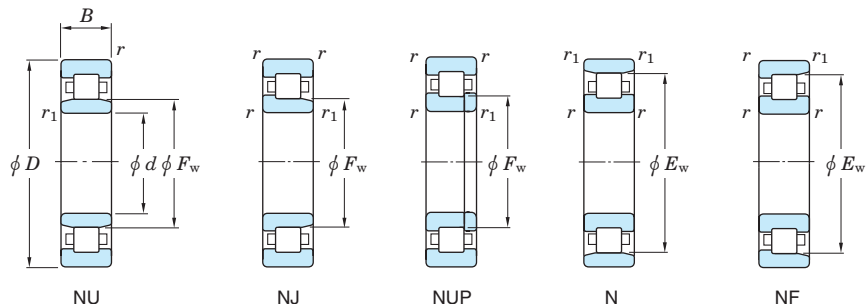

Boundary dimensions (mm)								Basic load ratings (kN)		Limiting speeds (min ⁻¹)		Bearing No.					Mounting dimensions (mm)								Mass NU (kg)	
d	D	B	r min.	r1 min.	Fw	Ew	Cr	C0r	Grease lub.	Oil lub.	NU	NJ	NUP	N	NF	da min.	db min.	db max.	dc min.	da min.	Da max.	Db max.	rb min.	ra max.		rb max.
190	340	92	4	4	228	—	1 100	1 670	1 500	2 000	NU2238R	NJ2238R	NUP2238R	—	—	206	206	227	234	247	324	—	—	3	3	37.0
	340	120	4	4	231	—	1 310	1 930	1 300	2 000	NU3238	—	—	—	—	206	206	227	234	—	324	—	—	3	3	46.8
	400	78	5	5	245	345	987	1 260	1 300	1 800	NU338	NJ338	NUP338	N338	NF338	210	210	240	248	268	380	380	349	4	4	49.9
	400	132	5	5	245	—	1 520	2 220	1 200	1 800	NU2338	NJ2338	NUP2338	—	—	210	210	240	248	268	380	—	—	4	4	84.7
	400	155	5	5	245	—	1 870	2 910	1 200	1 800	NU3338	—	—	—	—	210	210	240	248	—	380	—	—	4	4	96.5
200	310	51	2.1	2.1	229	—	388	582	1 900	2 300	NU1040	—	NUP1040	—	—	211	211	226	233	—	299	—	—	2	2	14.1
	360	58	4	4	244	316	618	865	1 600	1 900	NU240	NJ240	NUP240	N240	NF240	216	216	240	247	261	344	344	328	3	3	26.8
	360	58	4	4	243	—	766	1 060	1 600	1 900	NU240R	NJ240R	NUP240R	—	—	216	216	240	247	261	344	—	—	3	3	27.2
	360	98	4	4	244	—	946	1 490	1 400	1 900	NU2240	NJ2240	NUP2240	—	—	216	216	240	247	261	344	—	—	3	3	44.4
	360	98	4	4	241	—	1 220	1 870	1 400	1 900	NU2240R	NJ2240R	NUP2240R	—	—	216	216	240	247	261	344	—	—	3	3	44.4
	360	128	4	4	244	—	1 200	2 020	1 300	1 900	NU3240	—	—	—	—	216	216	240	247	—	344	—	—	3	3	56.2
	420	80	5	5	260	360	987	1 270	1 200	1 700	NU340	NJ340	NUP340	N340	NF340	220	220	254	263	283	400	400	364	4	4	56.2
	420	138	5	5	260	—	1 520	2 240	1 100	1 700	NU2340	NJ2340	NUP2340	—	—	220	220	254	263	283	400	—	—	4	4	97.4
	420	165	5	5	260	—	1 870	2 930	1 100	1 700	NU3340	—	—	—	—	220	220	250	258	—	400	—	—	4	4	113
220	340	56	3	3	250	—	507	748	1 700	2 000	NU1044	—	NUP1044	—	—	233	233	248	254	—	327	—	—	2.5	2.5	18.5
	400	65	4	4	270	350	766	1 080	1 400	1 700	NU244	NJ244	NUP244	N244	NF244	236	236	266	273	289	384	384	362	3	3	38.5
	400	108	4	4	270	—	1 130	1 810	1 200	1 700	NU244	NJ244	—	—	—	236	236	266	273	289	384	—	—	3	3	60.9
	400	144	4	4	270	—	1 630	2 880	1 100	1 700	NU3244	—	—	—	—	236	236	266	273	—	384	—	—	3	3	78.8
	460	88	5	5	284	396	1 200	1 570	1 100	1 500	NU344	NJ344	NUP344	N344	NF344	240	240	279	287	309	440	440	400	4	4	74.4
	460	145	5	5	284	—	1 810	2 690	990	1 500	NU2344	—	NUP2344	—	—	240	240	276	287	—	440	—	—	4	4	119
	460	180	5	5	284	—	2 130	3 300	990	1 500	NU3344	—	—	—	—	240	240	279	287	—	440	—	—	4	4	148
240	360	56	3	3	270	—	535	822	1 600	1 900	NU1048	—	NUP1048	—	—	253	253	268	275	—	347	—	—	2.5	2.5	20.1
	440	72	4	4	295	385	949	1 340	1 200	1 500	NU248	NJ248	NUP248	N248	NF248	256	256	293	298	316	424	424	397	3	3	52.1
	440	120	4	4	295	—	1 430	2 320	1 100	1 500	NU248	NJ248	—	—	—	256	256	293	298	316	424	—	—	3	3	82.5
	440	160	4	4	295	—	1 950	3 460	990	1 500	NU3248	—	—	—	—	256	256	293	298	—	424	—	—	3	3	107
	500	95	5	5	310	430	1 430	1 950	990	1 300	NU348	NJ348	NUP348	N348	NF348	260	260	305	313	337	480	480	434	4	4	94.6
	500	155	5	5	310	—	2 170	3 320	880	1 300	NU2348	—	NUP2348	—	—	260	260	303	313	—	480	—	—	4	4	152

[Remarks] 1) Standard cage types used for the above bearings are shown in Table 1 earlier in this section. Please note that basic load ratings and limiting speeds shown above indicate the value applicable to machined cage. Consult JTEKT about bearings with pressed cage, since they may be different from bearings with machined cage in values above.

2) Bearing numbers of NU and NJ type bearings with mounted thrust collar (refer to specification table shown after this specification table) are NUJ and NH.

Single-row cylindrical roller bearings

d (240) ~ 460 mm

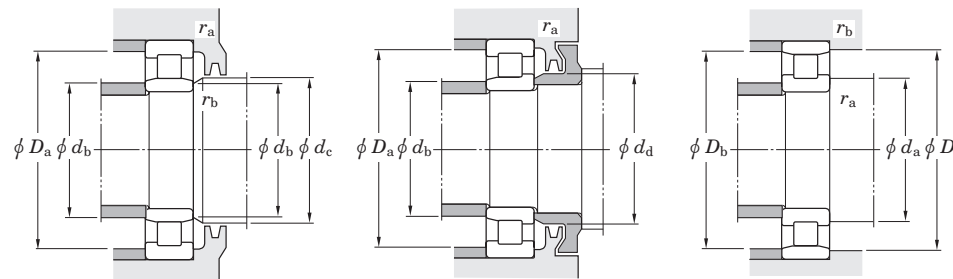
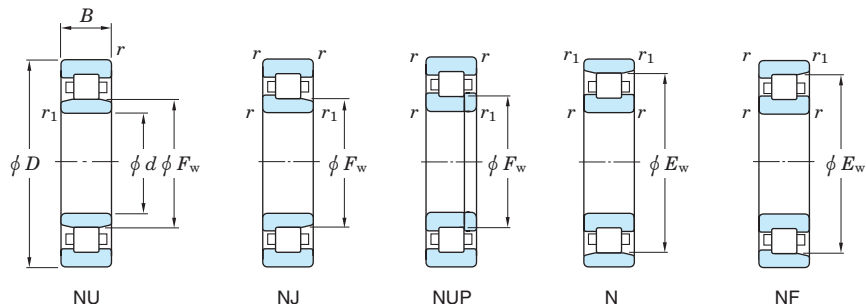

Boundary dimensions (mm)								Basic load ratings (kN)		Limiting speeds (min ⁻¹)		Bearing No.					Mounting dimensions (mm)								(Refer.)	
d	D	B	r min.	r_1 min.	F_w	E_w	C_r	C_{0r}	Grease lub.	Oil lub.	NU	NJ	NUP	N	NF	d_a min.	d_b min.	d_b max.	d_c min.	d_a min.	D_a max.	D_b max.	r_a min.	r_b max.	Mass NU (kg)	
240	500	195	5	5	310	—	2 540	4 070	880	1 300	NU3348	—	—	—	—	260	260	305	313	—	480	—	—	4	4	189
260	400	65	4	4	296	—	651	979	1 400	1 700	NU1052	—	NUP1052	—	—	276	276	292	300	—	384	—	—	3	3	29.2
	480	80	5	5	320	420	1 100	1 580	1 100	1 300	NU252	NJ252	NUP252	N252	NF252	280	280	318	323	343	460	460	432	4	4	69.0
	480	130	5	5	320	—	1 790	2 950	990	1 300	NU2252	NJ2252	—	—	—	280	280	318	323	343	460	—	—	4	4	107
	480	174	5	5	320	—	2 140	3 680	880	1 300	NU3252	—	—	—	—	280	280	318	323	—	460	—	—	4	4	139
	540	165	6	6	336	—	2 430	3 750	790	1 200	NU2352	—	NUP2352	—	—	284	284	327	339	—	516	—	—	5	5	185
	540	206	6	6	336	—	2 940	4 790	790	1 200	NU3352	—	—	—	—	284	284	330	339	—	516	—	—	5	5	232
280	420	65	4	4	316	—	669	1 030	1 300	1 500	NU1056	—	NUP1056	—	—	296	296	313	320	—	404	—	—	3	3	35.2
	500	80	5	5	340	440	1 140	1 680	1 000	1 200	NU256	NJ256	NUP256	N256	NF256	300	300	336	343	365	480	480	452	4	4	72.7
300	460	74	4	4	340	—	890	1 380	1 200	1 400	NU1060	—	NUP1060	—	—	316	316	337	344	—	444	—	—	3	3	44.1
	540	85	5	5	364	476	1 350	1 960	920	1 100	NU260	NJ260	NUP260	N260	NF260	320	320	361	368	392	520	520	487	4	4	90.7
320	480	74	4	4	360	—	913	1 450	1 100	1 300	NU1064	—	NUP1064	—	—	336	336	356	365	—	464	—	—	3	3	48.4
	580	92	5	5	390	510	1 540	2 270	840	1 000	NU264	NJ264	NUP264	N264	NF264	340	340	386	393	419	560	560	522	4	4	114
	670	112	7.5	7.5	425	—	1 970	2 880	650	870	NU364	—	—	—	—	352	352	419	428	—	638	638	575	6	6	199
340	520	82	5	5	385	—	1 090	1 750	980	1 200	NU1068	—	NUP1068	—	—	360	360	381	390	—	500	—	—	4	4	64.1
360	540	82	5	5	405	—	1 120	1 830	920	1 100	NU1072	—	NUP1072	—	—	380	380	401	410	—	520	—	—	4	4	67.1
380	560	82	5	5	425	—	1 150	1 920	860	1 000	NU1076	—	NUP1076	—	—	400	400	421	430	—	540	—	—	4	4	70.1
400	600	90	5	5	450	—	1 400	2 310	780	920	NU1080	—	NUP1080	—	—	420	420	446	455	—	580	—	—	4	4	91.0
420	620	90	5	5	470	—	1 390	2 320	730	860	NU1084	—	NUP1084	—	—	440	440	466	475	—	600	—	—	4	4	94.6
440	650	94	6	6	493	—	1 490	2 520	680	800	NU1088	—	NUP1088	—	—	464	464	489	498	—	626	—	—	5	5	109
460	680	100	6	6	516	—	1 590	2 730	630	750	NU1092	—	NUP1092	—	—	484	484	512	520	—	656	—	—	5	5	127

(Remarks) 1) Standard cage types used for the above bearings are shown in Table 1 earlier in this section. Please note that basic load ratings and limiting speeds shown above indicate the value applicable to machined cage. Consult JTEKT about bearings with pressed cage, since they may be different from bearings with machined cage in values above.

2) Bearing numbers of NU and NJ type bearings with mounted thrust collar (refer to specification table shown after this specification table) are NUJ and NH.

Thrust collars for cylindrical roller bearings

d 20 ~ (35) mm

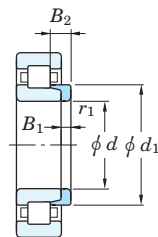

Thrust collar

d	Boundary dimensions (mm)				Thrust collar No.	(Refer.) Mass (kg)	Applicable bearing No.		
	d_1	B_1	B_2	r_1 min.			NJ	NU	
20	29.7	3	6.75	0.6	HJ204	0.012	NJ204	NU204	
	29.8	3	5.5	0.6	HJ204R	0.011	NJ204R	NU204R	
	30	3	7.5	0.6	HJ2204	0.012	NJ2204	NU2204	
	29.8	3	6.5	0.6	HJ2204R	0.012	NJ2204R	NU2204R	
	31.8	4	7.5	0.6	HJ304	0.017	NJ304	NU304	
	31.4	4	6.5	0.6	HJ304R	0.017	NJ304R	NU304R	
	31.8	4	8.5	0.6	HJ2304	0.020	NJ2304	NU2304	
	31.4	4	7.5	0.6	HJ2304R	0.018	NJ2304R	NU2304R	
	25	34.7	3	7.25	0.6	HJ205	0.015	NJ205	NU205
		34.8	3	6	0.6	HJ205R	0.014	NJ205R	NU205R
34.7		3	7.5	0.6	HJ2205	0.015	NJ2205	NU2205	
34.8		3	6.5	0.6	HJ2205R	0.014	NJ2205R	NU2205R	
39		4	8	1.1	HJ305	0.025	NJ305	NU305	
38.2		4	7	1.1	HJ305R	0.025	NJ305R	NU305R	
39		4	9	1.1	HJ2305	0.025	NJ2305	NU2305	
38.2		4	8	1.1	HJ2305R	0.026	NJ2305R	NU2305R	
30		41.8	4	8.25	0.6	HJ206	0.025	NJ206	NU206
		41.4	4	7	0.6	HJ206R	0.025	NJ206R	NU206R
	41.8	4	8.5	0.6	HJ2206	0.025	NJ2206	NU2206	
	41.4	4	7.5	0.6	HJ2206R	0.025	NJ2206R	NU2206R	
	45.9	5	9.5	1.1	HJ306	0.039	NJ306	NU306	
	45.1	5	8.5	1.1	HJ306R	0.042	NJ306R	NU306R	
	45.9	5	11.5	1.1	HJ2306	0.039	NJ2306	NU2306	
	45.1	5	9.5	1.1	HJ2306R	0.043	NJ2306R	NU2306R	
	50.5	7	11.5	1.5	HJ406	0.080	NJ406	NU406	
	35	47.6	4	8	0.6	HJ207	0.030	NJ207	NU207
48.2		4	7	0.6	HJ207R	0.033	NJ207R	NU207R	
47.6		4	8.5	0.6	HJ2207	0.030	NJ2207	NU2207	

d (35) ~ (50) mm

d	Boundary dimensions (mm)				Thrust collar No.	(Refer.) Mass (kg)	Applicable bearing No.	
	d_1	B_1	B_2	r_1 min.			NJ	NU
35	48.2	4	8.5	0.6	HJ2207R	0.035	NJ2207R	NU2207R
	50.8	6	11	1.1	HJ307	0.056	NJ307	NU307
	51.1	6	9.5	1.1	HJ307R	0.060	NJ307R	NU307R
	50.8	6	14	1.1	HJ2307	0.056	NJ2307	NU2307
	51.1	6	11	1.1	HJ2307R	0.062	NJ2307R	NU2307R
	59	8	13	1.5	HJ407	0.120	NJ407	NU407
	40	54.2	5	9	1.1	HJ208	0.046	NJ208
54.1		5	8.5	1.1	HJ208R	0.049	NJ208R	NU208R
54.2		5	9.5	1.1	HJ2208	0.046	NJ2208	NU2208
54.1		5	9	1.1	HJ2208R	0.050	NJ2208R	NU2208R
58.4		7	12.5	1.5	HJ308	0.083	NJ308	NU308
57.7		7	11	1.5	HJ308R	0.088	NJ308R	NU308R
58.4		7	14.5	1.5	HJ2308	0.083	NJ2308	NU2308
57.7		7	12.5	1.5	HJ2308R	0.091	NJ2308R	NU2308R
64.8		8	13	2	HJ408	0.140	NJ408	NU408
45		59	5	9.5	1.1	HJ209	0.053	NJ209
	59.1	5	8.5	1.1	HJ209R	0.055	NJ209R	NU209R
	59	5	9.5	1.1	HJ2209	0.053	NJ2209	NU2209
	59.1	5	9	1.1	HJ2209R	0.055	NJ2209R	NU2209R
	64	7	12.5	1.5	HJ309	0.099	NJ309	NU309
	64.5	7	11.5	1.5	HJ309R	0.110	NJ309R	NU309R
	64	7	15	1.5	HJ2309	0.099	NJ2309	NU2309
	64.5	7	13	1.5	HJ2309R	0.113	NJ2309R	NU2309R
	71.8	8	13.5	2	HJ409	0.175	NJ409	NU409
	50	64.6	5	10	1.1	HJ210	0.063	NJ210
64.1		5	9	1.1	HJ210R	0.061	NJ210R	NU210R
64.6		5	9.5	1.1	HJ2210	0.063	NJ2210	NU2210
64.1		5	9	1.1	HJ2210R	0.061	NJ2210R	NU2210R
71		8	14	2	HJ310	0.142	NJ310	NU310

Thrust collars for cylindrical roller bearings

d (50) ~ (65) mm

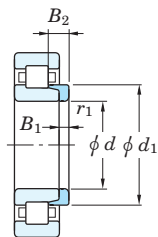

Thrust collar

d	Boundary dimensions (mm)				Thrust collar No.	(Refer.) Mass (kg)	Applicable bearing No.	
	d_1	B_1	B_2	r_1 min.			NJ	NU
50	71.4	8	13	2	HJ310R	0.151	NJ310R	NU310R
	71	8	17	2	HJ2310	0.142	NJ2310	NU2310
	71.4	8	14.5	2	HJ2310R	0.155	NJ2310R	NU2310R
	78.8	9	14.5	2.1	HJ410	0.230	NJ410	NU410
55	70.8	6	11	1.1	HJ211	0.084	NJ211	NU211
	70.9	6	9.5	1.1	HJ211R	0.087	NJ211R	NU211R
	70.8	6	11	1.1	HJ2211	0.084	NJ2211	NU2211
	70.9	6	10	1.1	HJ2211R	0.088	NJ2211R	NU2211R
	77.2	9	15	2	HJ311	0.182	NJ311	NU311
	77.6	9	14	2	HJ311R	0.195	NJ311R	NU311R
	77.2	9	18.5	2	HJ2311	0.182	NJ2311	NU2311
	77.6	9	15.5	2	HJ2311R	0.200	NJ2311R	NU2311R
	85.2	10	16.5	2.1	HJ411	0.290	NJ411	NU411
	60	78.4	6	11	1.5	HJ212	0.108	NJ212
77.7		6	10	1.5	HJ212R	0.108	NJ212R	NU212R
78.4		6	11	1.5	HJ2212	0.108	NJ2212	NU2212
77.7		6	10	1.5	HJ2212R	0.108	NJ2212R	NU2212R
84.2		9	15.5	2.1	HJ312	0.220	NJ312	NU312
84.5		9	14.5	2.1	HJ312R	0.231	NJ312R	NU312R
84.2		9	19	2.1	HJ2312	0.220	NJ2312	NU2312
84.5		9	16	2.1	HJ2312R	0.237	NJ2312R	NU2312R
91.8		10	16.5	2.1	HJ412	0.340	NJ412	NU412
65		84.8	6	11	1.5	HJ213	0.123	NJ213
	84.5	6	10	1.5	HJ213R	0.129	NJ213R	NU213R
	84.8	6	11.5	1.5	HJ2213	0.123	NJ2213	NU2213
	84.5	6	10.5	1.5	HJ2213R	0.131	NJ2213R	NU2213R
	91	10	17	2.1	HJ313	0.280	NJ313	NU313
	90.6	10	15.5	2.1	HJ313R	0.288	NJ313R	NU313R

d (65) ~ (80) mm

d	Boundary dimensions (mm)				Thrust collar No.	(Refer.) Mass (kg)	Applicable bearing No.	
	d_1	B_1	B_2	r_1 min.			NJ	NU
65	91	10	20	2.1	HJ2313	0.280	NJ2313	NU2313
	90.6	10	18	2.1	HJ2313R	0.298	NJ2313R	NU2313R
	98.5	11	18	2.1	HJ413	0.420	NJ413	NU413
70	89.6	7	12.5	1.5	HJ214	0.150	NJ214	NU214
	89.5	7	11	1.5	HJ214R	0.157	NJ214R	NU214R
	89.6	7	12.5	1.5	HJ2214	0.150	NJ2214	NU2214
	89.5	7	11.5	1.5	HJ2214R	0.158	NJ2214R	NU2214R
	98	10	17.5	2.1	HJ314	0.330	NJ314	NU314
	97.5	10	15.5	2.1	HJ314R	0.330	NJ314R	NU314R
	98	10	20.5	2.1	HJ2314	0.330	NJ2314	NU2314
	97.5	10	18.5	2.1	HJ2314R	0.345	NJ2314R	NU2314R
	110.5	12	20	3	HJ414	0.605	NJ414	NU414
	75	94	7	12.5	1.5	HJ215	0.156	NJ215
94.5		7	11	1.5	HJ215R	0.166	NJ215R	NU215R
94		7	12.5	1.5	HJ2215	0.156	NJ2215	NU2215
94.5		7	11.5	1.5	HJ2215R	0.167	NJ2215R	NU2215R
104.2		11	18.5	2.1	HJ315	0.400	NJ315	NU315
104.2		11	16.5	2.1	HJ315R	0.410	NJ315R	NU315R
104.2		11	21.5	2.1	HJ2315	0.400	NJ2315	NU2315
104.2		11	19.5	2.1	HJ2315R	0.430	NJ2315R	NU2315R
116		13	21.5	3	HJ415	0.710	NJ415	NU415
80		101.2	8	13.5	2	HJ216	0.207	NJ216
	101.6	8	12.5	2	HJ216R	0.222	NJ216R	NU216R
	101.2	8	13.5	2	HJ2216	0.207	NJ2216	NU2216
	101.6	8	12.5	2	HJ2216R	0.222	NJ2216R	NU2216R
	111.8	11	19.5	2.1	HJ316	0.470	NJ316	NU316
	110.6	11	17	2.1	HJ316R	0.460	NJ316R	NU316R
	111.8	11	23	2.1	HJ2316	0.470	NJ2316	NU2316
	110.6	11	20	2.1	HJ2316R	0.480	NJ2316R	NU2316R

Thrust collars for cylindrical roller bearings

d (80) ~ (100) mm

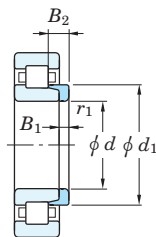

Thrust collar

Boundary dimensions (mm)					Thrust collar No.	(Refer.) Mass (kg)	Applicable bearing No.	
d	d_1	B_1	B_2	r_1 min.			NJ	NU
80	122	13	22	3	HJ416	0.780	NJ416	NU416
85	108.2	8	14	2	HJ217	0.250	NJ217	NU217
	107.6	8	12.5	2	HJ217R	0.250	NJ217R	NU217R
	108.2	8	14	2	HJ2217	0.250	NJ2217	NU2217
	107.6	8	13	2	HJ2217R	0.252	NJ2217R	NU2217R
	117.5	12	20.5	3	HJ317	0.560	NJ317	NU317
	117.9	12	18.5	3	HJ317R	0.575	NJ317R	NU317R
	117.5	12	24	3	HJ2317	0.560	NJ2317	NU2317
	117.9	12	22	3	HJ2317R	0.595	NJ2317R	NU2317R
126	14	24	4	HJ417	0.880	NJ417	NU417	
90	114.2	9	15	2	HJ218	0.305	NJ218	NU218
	114.4	9	14	2	HJ218R	0.320	NJ218R	NU218R
	114.2	9	16	2	HJ2218	0.305	NJ2218	NU2218
	114.4	9	15	2	HJ2218R	0.325	NJ2218R	NU2218R
	125	12	21	3	HJ318	0.630	NJ318	NU318
	124.2	12	18.5	3	HJ318R	0.630	NJ318R	NU318R
	125	12	26	3	HJ2318	0.630	NJ2318	NU2318
	124.2	12	22	3	HJ2318R	0.660	NJ2318R	NU2318R
	137	14	24	4	HJ418	1.05	NJ418	NU418
	95	121	9	15.5	2.1	HJ219	0.352	NJ219
120.6		9	14	2.1	HJ219R	0.355	NJ219R	NU219R
121		9	16.5	2.1	HJ2219	0.352	NJ2219	NU2219
120.6		9	15.5	2.1	HJ2219R	0.365	NJ2219R	NU2219R
132		13	22.5	3	HJ319	0.760	NJ319	NU319
132.2		13	20.5	3	HJ319R	0.785	NJ319R	NU319R
132		13	26.5	3	HJ2319	0.760	NJ2319	NU2319
147		15	25.5	4	HJ419	1.30	NJ419	NU419
100	128	10	17	2.1	HJ220	0.444	NJ220	NU220

d (100) ~ 120 mm

Boundary dimensions (mm)					Thrust collar No.	(Refer.) Mass (kg)	Applicable bearing No.		
d	d_1	B_1	B_2	r_1 min.			NJ	NU	
100	127.5	10	15	2.1	HJ220R	0.435	NJ220R	NU220R	
	128	10	18	2.1	HJ2220	0.444	NJ2220	NU2220	
	127.5	10	16	2.1	HJ2220R	0.450	NJ2220R	NU2220R	
	140.5	13	22.5	3	HJ320	0.895	NJ320	NU320	
	139.6	13	20.5	3	HJ320R	0.890	NJ320R	NU320R	
	140.5	13	27.5	3	HJ2320	0.895	NJ2320	NU2320	
	139.6	13	23.5	3	HJ2320R	0.920	NJ2320R	NU2320R	
	153.5	16	27	4	HJ420	1.50	NJ420	NU420	
	105	135	10	17.5	2.1	HJ221	0.505	NJ221	NU221
		147	13	22.5	3	HJ321	0.970	NJ321	NU321
159.5		16	27	4	HJ421	1.65	NJ421	NU421	
110	141.5	11	18.5	2.1	HJ222	0.615	NJ222	NU222	
	141.7	11	17	2.1	HJ222R	0.620	NJ222R	NU222R	
	141.5	11	20.5	2.1	HJ2222	0.615	NJ2222	NU2222	
	141.7	11	19.5	2.1	HJ2222R	0.645	NJ2222R	NU2222R	
	155.5	14	23	3	HJ322	1.17	NJ322	NU322	
	155.8	14	22	3	HJ322R	1.21	NJ322R	NU322R	
	155.5	14	28	3	HJ2322	1.17	NJ2322	NU2322	
	155.8	14	26.5	3	HJ2322R	1.27	NJ2322R	NU2322R	
	171	17	29.5	4	HJ422	2.10	NJ422	NU422	
	120	153	11	19	2.1	HJ224	0.715	NJ224	NU224
153.4		11	17	2.1	HJ224R	0.710	NJ224R	NU224R	
153		11	22	2.1	HJ2224	0.715	NJ2224	NU2224	
153.4		11	20	2.1	HJ2224R	0.745	NJ2224R	NU2224R	
168.5		14	23.5	3	HJ324	1.40	NJ324	NU324	
168.6		14	22.5	3	HJ324R	1.41	NJ324R	NU324R	
168.5		14	28	3	HJ2324	1.40	NJ2324	NU2324	
168.6		14	26	3	HJ2324R	1.46	NJ2324R	NU2324R	
188		17	30.5	5	HJ424	2.60	NJ424	NU424	

Thrust collars for cylindrical roller bearings

d 130 ~ (160) mm

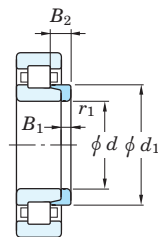

Thrust collar

d (160) ~ (200) mm

d	Boundary dimensions (mm)				r_1 min.	Thrust collar No.	(Refer.) Mass (kg)	Applicable bearing No.	
	d_1	B_1	B_2					NJ	NU
130	165.5	11	19		3	HJ226	0.840	NJ226	NU226
	164.2	11	17		3	HJ226R	0.790	NJ226R	NU226R
	165.5	11	25		3	HJ2226	0.840	NJ2226	NU2226
	164.2	11	21		3	HJ2226R	0.840	NJ2226R	NU2226R
	182	14	24		4	HJ326	1.62	NJ326	NU326
	182.3	14	23		4	HJ326R	1.65	NJ326R	NU326R
	182	14	29.5		4	HJ2326	1.62	NJ2326	NU2326
	182.3	14	28		4	HJ2326R	1.73	NJ2326R	NU2326R
	205	18	32		5	HJ426	3.30	NJ426	NU426
	140	179.5	11	19		3	HJ228	1.00	NJ228
180		11	18		3	HJ228R	0.990	NJ228R	NU228R
179.5		11	25		3	HJ2228	1.00	NJ2228	NU2228
180		11	23		3	HJ2228R	1.07	NJ2228R	NU2228R
196		15	26		4	HJ328	1.93	NJ328	NU328
196		15	25		4	HJ328R	2.04	NJ328R	NU328R
196		15	33.5		4	HJ2328	1.98	NJ2328	NU2328
196		15	31		4	HJ2328R	2.14	NJ2328R	NU2328R
219		18	33		5	HJ428	3.75	NJ428	NU428
150		193	12	20.5		3	HJ230	1.24	NJ230
	193.7	12	19.5		3	HJ230R	1.26	NJ230R	NU230R
	193	12	26.5		3	HJ2230	1.24	NJ2230	NU2230
	193.7	12	24.5		3	HJ2230R	1.35	NJ2230R	NU2230R
	210	15	26.5		4	HJ330	2.37	NJ330	NU330
	210	15	25		4	HJ330R	2.35	NJ330R	NU330R
	210	15	34		4	HJ2330	2.37	NJ2330	NU2330
	210	15	31.5		4	HJ2330R	2.48	NJ2330R	NU2330R
	234	20	36.5		5	HJ430	4.70	NJ430	NU430
	160	207	12	21		3	HJ232	1.48	NJ232
207.3		12	20		3	HJ232R	1.48	NJ232R	NU232R

d	Boundary dimensions (mm)				r_1 min.	Thrust collar No.	(Refer.) Mass (kg)	Applicable bearing No.	
	d_1	B_1	B_2					NJ	NU
160	205	12	28		3	HJ2232	1.48	NJ2232	NU2232
	206.1	12	24.5		3	HJ2232R	1.55	NJ2232R	NU2232R
	225	15	28		4	HJ332	2.75	NJ332	NU332
	222.1	15	25		4	HJ332R	2.59	NJ332R	NU332R
	225	15	37		4	HJ2332	2.75	NJ2332	NU2332
	222.1	15	32		4	HJ2332R	2.76	NJ2332R	NU2332R
	170	220.5	12	22		4	HJ234	1.70	NJ234
220.8		12	20		4	HJ234R	1.70	NJ234R	NU234R
219		12	29		4	HJ2234	1.70	NJ2234	NU2234
219.5		12	24		4	HJ2234R	1.79	NJ2234R	NU2234R
238		16	29.5		4	HJ334	3.25	NJ334	NU334
238		16	38.5		4	HJ2334	3.25	NJ2334	NU2334
180	230.5	12	22		4	HJ236	1.80	NJ236	NU236
	230.8	12	20		4	HJ236R	1.79	NJ236R	NU236R
	229	12	29		4	HJ2236	1.80	NJ2236	NU2236
	229.5	12	24		4	HJ2236R	1.88	NJ2236R	NU2236R
	252	17	30.5		4	HJ336	3.85	NJ336	NU336
	252	17	40		4	HJ2336	3.85	NJ2336	NU2336
	190	244.5	13	23.5		4	HJ238	2.20	NJ238
244.5		13	21.5		4	HJ238R	2.19	NJ238R	NU238R
243		13	31.5		4	HJ2238	2.20	NJ2238	NU2238
243.2		13	26.5		4	HJ2238R	2.31	NJ2238R	NU2238R
265		18	32		5	HJ338	4.45	NJ338	NU338
265		18	41.5		5	HJ2338	4.45	NJ2338	NU2338
200	258	14	25		4	HJ240	2.60	NJ240	NU240
	258.2	14	23		4	HJ240R	2.65	NJ240R	NU240R
	258	14	34		4	HJ2240	2.60	NJ2240	NU2240
	256.9	14	28		4	HJ2240R	2.78	NJ2240R	NU2240R
	280	18	33		5	HJ340	5.00	NJ340	NU340

Thrust collars for cylindrical roller bearings

d (200) ~ 320 mm

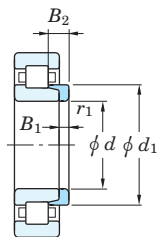

Thrust collar

d	Boundary dimensions (mm)				Thrust collar No.	(Refer.) Mass (kg)	Applicable bearing No.	
	d_1	B_1	B_2	r_1 min.			NJ	NU
200	280	18	44.5	5	HJ2340	5.00	NJ2340	NU2340
220	286	15	27.5	4	HJ244	3.55	NJ244	NU244
	286	15	36.5	4	HJ2244	3.55	NJ2244	NU2244
	307	20	36	5	HJ344	7.05	NJ344	NU344
240	313	16	29.5	4	HJ248	4.65	NJ248	NU248
	313	16	38.5	4	HJ2248	4.65	NJ2248	NU2248
	335	22	39.5	5	HJ348	8.20	NJ348	NU348
260	340	18	33	5	HJ252	6.20	NJ252	NU252
	340	18	40.5	5	HJ2252	6.20	NJ2252	NU2252
280	360	18	33	5	HJ256	7.15	NJ256	NU256
300	387	20	34.5	5	HJ260	7.40	NJ260	NU260
320	415	21	37	5	HJ264	11.3	NJ264	NU264

Double-row cylindrical roller bearings

d 25 ~ (110) mm

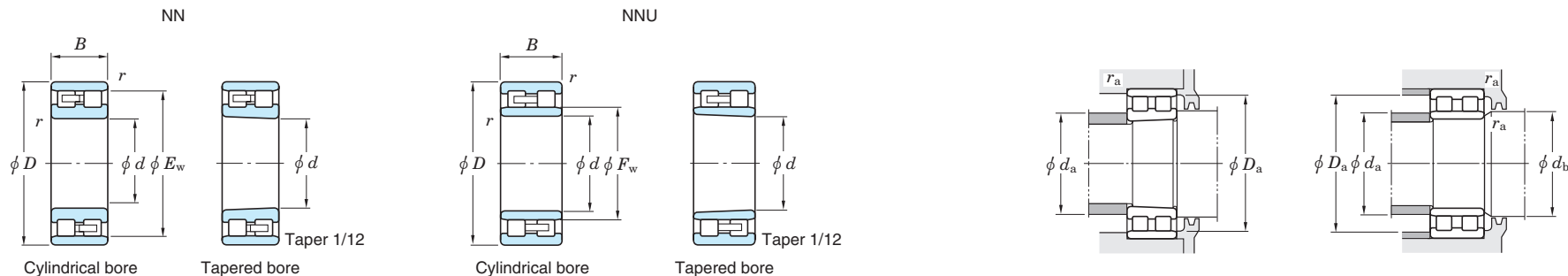

Boundary dimensions (mm)						Basic load ratings (kN)		Limiting speeds (min ⁻¹)		Bearing No.		Mounting dimensions (mm)						(Refer.) Mass (kg)			
d	D	B	$r_{min.}$	F_w	E_w	C_r	C_{0r}	Grease lub.	Oil lub.	NN		NNU		min. d_a	max. d_b	min. D_a	max. r_a	Cylindrical bore	Tapered bore		
										Cylindrical bore	Tapered bore	Cylindrical bore	Tapered bore								
25	47	16	0.6	—	41.3	25.7	30.0	14 000	17 000	NN3005	NN3005K	—	—	29	—	—	43	42	0.6	0.127	0.123
30	55	19	1	—	48.5	36.8	44.1	12 000	14 000	NN3006	NN3006K	—	—	35	—	—	50	49	1	0.198	0.192
35	62	20	1	—	55	39.1	50.0	10 000	12 000	NN3007	NN3007K	—	—	40	—	—	57	56	1	0.253	0.246
40	68	21	1	—	61	41.3	55.9	9 100	11 000	NN3008	NN3008K	—	—	45	—	—	63	62	1	0.307	0.298
45	75	23	1	—	67.5	53.4	71.9	8 300	9 900	NN3009	NN3009K	—	—	50	—	—	70	69	1	0.404	0.382
50	80	23	1	—	72.5	52.8	72.6	7 600	9 100	NN3010	NN3010K	—	—	55	—	—	75	74	1	0.429	0.415
55	90	26	1.1	—	81	71.2	101	6 800	8 200	NN3011	NN3011K	—	—	61.5	—	—	83.5	82	1	0.637	0.618
60	95	26	1.1	—	86.1	72.8	106	6 400	7 700	NN3012	NN3012K	—	—	66.5	—	—	88.5	87	1	0.685	0.664
65	100	26	1.1	—	91	74.5	111	6 000	7 200	NN3013	NN3013K	—	—	71.5	—	—	93.5	92	1	0.728	0.705
70	110	30	1.1	—	100	96.9	148	5 500	6 500	NN3014	NN3014K	—	—	76.5	—	—	103.5	101	1	1.04	1.02
75	115	30	1.1	—	105	99.0	155	5 200	6 200	NN3015	NN3015K	—	—	81.5	—	—	108.5	106	1	1.11	1.08
80	125	34	1.1	—	113	119	186	4 800	5 800	NN3016	NN3016K	—	—	86.5	—	—	118.5	114	1	1.55	1.50
85	130	34	1.1	—	118	121	194	4 600	5 500	NN3017	NN3017K	—	—	91.5	—	—	123.5	119	1	1.63	1.58
90	140	37	1.5	—	127	142	228	4 200	5 100	NN3018	NN3018K	—	—	98	—	—	132	129	1.5	2.07	2.01
95	145	37	1.5	—	132	150	246	4 100	4 900	NN3019	NN3019K	—	—	103	—	—	137	134	1.5	2.17	2.10
100	140	40	1.1	113	—	139	258	4 000	4 800	—	—	—	—	106.5	111	115	133.5	—	1	1.95	1.87
	150	37	1.5	—	137	157	265	3 900	4 700	NN3020	NN3020K	—	—	108	—	—	142	139	1.5	2.28	2.21
105	145	40	1.1	118	—	157	306	3 900	4 600	—	—	—	—	111.5	116	120	138.5	—	1	2.00	1.91
	160	41	2	—	146	197	322	3 700	4 400	NN3021	NN3021K	—	—	114	—	—	151	148	2	2.88	2.81
110	150	40	1.1	123	—	163	326	3 700	4 500	—	—	—	—	116.5	121	125	143.5	—	1	2.10	2.01

Double-row cylindrical roller bearings

d (110) ~ (260) mm

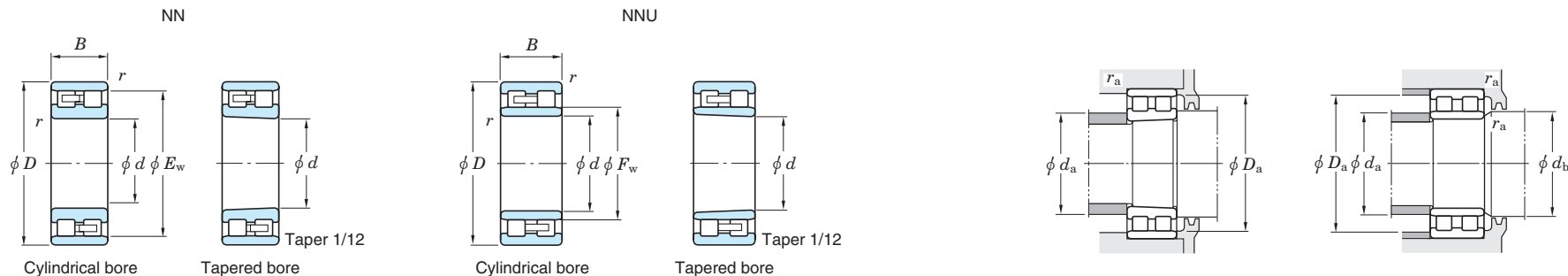

Boundary dimensions (mm)						Basic load ratings (kN)		Limiting speeds (min ⁻¹)		Bearing No.		Mounting dimensions (mm)						(Refer.) Mass (kg)					
d	D	B	$r_{min.}$	F_w	E_w	C_r	C_{0r}	Grease lub.	Oil lub.	NN		NNU		d_a min.	d_a max.	d_b min.	d_b max.	D_a min.	D_a max.	r_a min.	r_a max.	Cylindrical bore	Tapered bore
										Cylindrical bore	Tapered bore	Cylindrical bore	Tapered bore										
110	170	45	2	—	155	221	361	3 500	4 200	NN3022	NN3022K	—	—	119	—	—	161	157	2	—	—	3.65	3.56
120	165	45	1.1	134.5	—	187	373	3 400	4 000	—	—	NNU4924	NNU4924K	126.5	132	137	158.5	—	1	—	—	2.90	2.77
	180	46	2	—	165	232	392	3 200	3 900	NN3024	NN3024K	—	—	129	—	—	171	167	2	—	—	4.00	3.87
130	180	50	1.5	146	—	216	428	3 100	3 700	—	—	NNU4926	NNU4926K	138	143.5	148	172	—	1.5	—	—	3.90	3.73
	200	52	2	—	182	283	476	2 900	3 500	NN3026	NN3026K	—	—	139	—	—	191	183	2	—	—	5.94	5.76
140	190	50	1.5	156	—	222	456	2 900	3 500	—	—	NNU4928	NNU4928K	148	153.5	158	182	—	1.5	—	—	4.15	3.97
	210	53	2	—	192	297	516	2 700	3 300	NN3028	NN3028K	—	—	149	—	—	201	194	2	—	—	6.41	6.21
150	210	60	2	168.5	—	343	692	2 600	3 100	—	—	NNU4930	NNU4930K	159	166	171	201	—	2	—	—	6.50	6.22
	225	56	2.1	—	206	334	587	2 500	3 000	NN3030	NN3030K	—	—	161	—	—	214	208	2	—	—	7.74	7.50
160	220	60	2	178.5	—	340	695	2 500	3 000	—	—	NNU4932	NNU4932K	169	176	182	211	—	2	—	—	6.95	6.65
	240	60	2.1	—	219	398	695	2 400	2 800	NN3032	NN3032K	—	—	171	—	—	229	221	2	—	—	9.38	9.08
170	230	60	2	188.5	—	361	763	2 300	2 800	—	—	NNU4934	NNU4934K	179	186	192	221	—	2	—	—	7.20	6.88
	260	67	2.1	—	236	471	824	2 200	2 600	NN3034	NN3034K	—	—	181	—	—	249	238	2	—	—	12.8	12.4
180	250	69	2	202	—	458	964	2 100	2 600	—	—	NNU4936	NNU4936K	189	199.5	205	241	—	2	—	—	10.5	10.1
	280	74	2.1	—	255	561	958	2 000	2 400	NN3036	NN3036K	—	—	191	—	—	269	257	2	—	—	16.8	16.3
190	260	69	2	210	—	465	996	2 000	2 400	—	—	NNU4938	NNU4938K	199	207	215	251	—	2	—	—	11.0	10.5
	290	75	2.1	—	265	598	1 020	1 900	2 300	NN3038	NN3038K	—	—	201	—	—	279	267	2	—	—	17.6	17.1
200	280	80	2.1	223	—	509	1 050	1 900	2 300	—	—	NNU4940	NNU4940K	211	219.5	228	269	—	2	—	—	15.4	14.7
	310	82	2.1	—	282	638	1 120	1 700	2 100	NN3040	NN3040K	—	—	211	—	—	299	285	2	—	—	22.5	21.8
220	300	80	2.1	244	—	561	1 220	1 700	2 000	—	—	NNU4944	NNU4944K	231	241	248	289	—	2	—	—	16.7	16.0
	340	90	3	—	310	752	1 370	1 600	1 900	NN3044	NN3044K	—	—	233	—	—	327	313	2.5	—	—	29.3	28.4
240	320	80	2.1	263	—	588	1 340	1 600	1 900	—	—	NNU4948	NNU4948K	251	260	269	309	—	2	—	—	18.0	17.2
	360	92	3	—	330	864	1 590	1 400	1 700	NN3048	NN3048K	—	—	253	—	—	347	333	2.5	—	—	32.8	31.8
260	360	100	2.1	287	—	941	2 050	1 400	1 700	—	—	NNU4952	NNU4952K	271	284	296	349	—	2	—	—	31.4	30.0

Double-row cylindrical roller bearings

d (260) ~ 480 mm

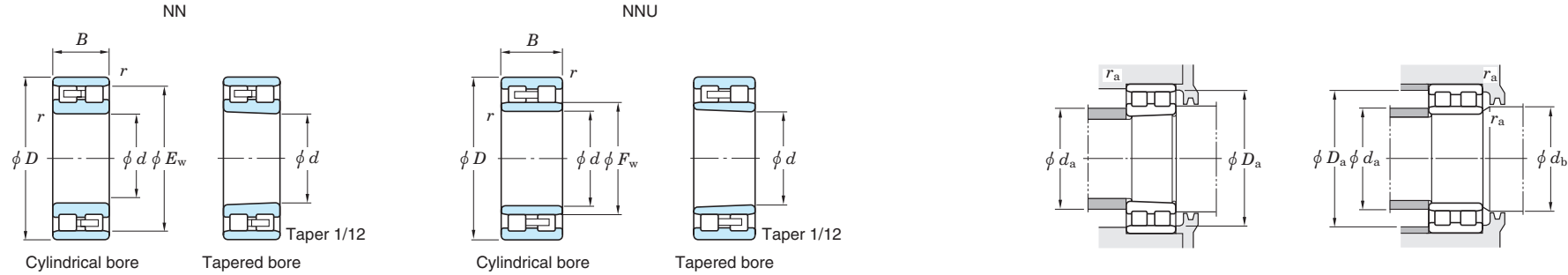

Boundary dimensions (mm)						Basic load ratings (kN)		Limiting speeds (min ⁻¹)		Bearing No.		Mounting dimensions (mm)						(Refer.) Mass (kg)					
d	D	B	$r_{min.}$	F_w	E_w	C_r	C_{0r}	Grease lub.	Oil lub.	NN		NNU		min. d_a	max. d_a	min. d_b	max. d_b	min. D_a	max. D_a	min. r_a	max. r_a	Cylindrical bore	Tapered bore
										Cylindrical bore	Tapered bore	Cylindrical bore	Tapered bore										
260	400	104	4	—	364	1 030	1 830	1 300	1 500	NN3052	NN3052K	—	—	276	—	—	384	367	3	—	—	47.4	46.0
	420	106	4	—	384	1 090	2 010	1 200	1 400	NN3056	NN3056K	—	—	291	305	316	369	—	2	—	—	33.1	31.6
300	420	118	3	339	—	1 170	2 720	1 100	1 300	—	—	NNU4956	NNU4956K	291	305	316	369	—	2	—	—	33.1	31.6
	460	118	4	—	418	1 290	2 460	1 100	1 300	NN3060	NN3060K	—	—	296	—	—	404	387	3	—	—	51.2	49.6
320	440	118	3	352	—	1 220	2 750	1 100	1 300	—	—	NNU4960	NNU4960K	313	335	343	407	—	2.5	—	—	51.9	49.7
	480	121	4	—	438	1 350	2 670	980	1 200	NN3064	NN3064K	—	—	316	—	—	444	421	3	—	—	70.8	68.7
340	440	118	3	372	—	1 220	2 750	1 100	1 300	—	—	NNU4964	NNU4964K	333	348	363	427	—	2.5	—	—	53.7	51.4
	520	133	5	—	473	1 580	3 090	880	1 100	NN3068	NN3068K	—	—	336	—	—	464	442	3	—	—	76.4	74.0
360	460	118	3	372	—	1 270	2 930	990	1 200	—	—	NNU4968	NNU4968K	353	368	383	447	—	2.5	—	—	56.8	54.3
	520	133	5	—	473	1 580	3 090	880	1 100	NN3068	NN3068K	—	—	360	—	—	500	477	4	—	—	101	97.8
360	540	134	5	—	493	1 560	3 090	830	990	NN3072	NN3072K	—	—	380	—	—	520	497	4	—	—	107	104
380	560	135	5	—	510	1 650	3 350	780	940	NN3076	NN3076K	—	—	400	—	—	540	514	4	—	—	113	109
400	600	148	5	—	548	2 030	4 140	700	850	NN3080	NN3080K	—	—	420	—	—	580	552	4	—	—	146	141
420	620	150	5	—	570	2 310	4 570	670	800	NN3084	NN3084K	—	—	440	—	—	600	574	4	—	—	154	149
440	650	157	6	—	597	2 520	5 060	620	740	NN3088	NN3088K	—	—	464	—	—	626	602	5	—	—	177	171
460	680	163	6	—	627	2 700	5 480	570	690	NN3092	NN3092K	—	—	484	—	—	656	632	5	—	—	201	195
480	700	165	6	—	642	2 770	5 710	540	650	NN3096	NN3096K	—	—	504	—	—	676	647	5	—	—	211	204

Tapered roller bearings

Tapered roller bearings are designed such that outer ring, inner ring and rollers have tapered surfaces whose apexes converge at a common point on the bearing axis. Along with metric series bearings, inch series bearings are also available. This type of bearing is suitable for applications that involve heavy or impact loading.

■ Single-row tapered roller bearings

- Able to carry radial and axial load in one direction simultaneously.

Because an axial component of force is produced when this type of bearing is loaded radially, two bearings are used together facing one another, or two or more bearings are matched and used.

- There are the standard, medium and steep type which are different in contact angle size. Medium-tapered metric series bearings are identified by the supplementary code "C" which is added as a suffix to bearing numbers.

- Bearings whose outer ring width, outer ring small inside diameter and contact angle are determined in accordance with ISO 355 specifications are identified by the supplementary code "J" as a suffix.

Inner ring assemblies and the outer rings of such bearings are interchangeable with those of bearings produced abroad if the bearing numbers are the same.

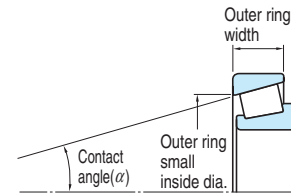

ISO sub-unit specifications

■ Double-row tapered roller bearings

- These bearings are divided into the TDO type which has one double outer ring and two single-row inner rings, and the TDI type which has two single-row outer rings and one double inner ring. Both accommodate radial and axial loading in both directions.

These two also carry moment loads, however, the TDO type is superior to the TDI type, because the distance between load centers (α) is longer in the TDO type.

- The spacer of the TDO type, or the TDI type, pre-adjusts the internal clearance to provide proper operating clearance after mounting.

Single-row tapered roller bearings



Metric series

Bore diameter **15 – 360 mm**



Inch series

(including J series metric bearing)

Bore diameter **9.525 – 292.100 mm**

Double-row tapered roller bearings

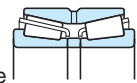

TDO type

Bore diameter **25 – 500 mm**

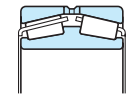

TDI type

Bore diameter **100 – 500 mm**

[Note] When supplementary code "J" is added as a prefix (not a suffix) to bearing numbers (e.g. JHM720249/JHM720210), the bearings are not designed according to ISO 355. Such bearings are called "J series metric tapered roller bearings," and are produced according to special tolerances.



Boundary dimensions	Metric single-row tapered roller bearings : as specified in JIS B 1512.																																								
	<p>Reference JIS B 1512 specifies new dimension series which are based on ISO 355, as well as the conventional "3XX" dimension series. These new dimension series are as follows :</p> <p style="text-align: center;">New dimension series</p> <div style="display: flex; justify-content: space-around;"> <div style="text-align: center;"> <p>(1) Angle series</p> <table border="1"> <thead> <tr> <th rowspan="2">Angle series</th> <th colspan="2">Contact angle α</th> </tr> <tr> <th>over</th> <th>up to</th> </tr> </thead> <tbody> <tr><td>2</td><td>10°</td><td>13° 52'</td></tr> <tr><td>3</td><td>13° 52'</td><td>15° 59'</td></tr> <tr><td>4</td><td>15° 59'</td><td>18° 55'</td></tr> <tr><td>5</td><td>18° 55'</td><td>23°</td></tr> <tr><td>6</td><td>23°</td><td>27°</td></tr> <tr><td>7</td><td>27°</td><td>30°</td></tr> </tbody> </table> </div> <div style="text-align: center;"> <p>(3) Width series</p> <table border="1"> <thead> <tr> <th rowspan="2">Width series</th> <th colspan="2">$T/\{(D-d)^{0.95}\}$</th> </tr> <tr> <th>over</th> <th>up to</th> </tr> </thead> <tbody> <tr><td>B</td><td>0.50</td><td>0.68</td></tr> <tr><td>C</td><td>0.68</td><td>0.80</td></tr> <tr><td>D</td><td>0.80</td><td>0.88</td></tr> <tr><td>E</td><td>0.88</td><td>1.00</td></tr> </tbody> </table> </div> </div>	Angle series	Contact angle α		over	up to	2	10°	13° 52'	3	13° 52'	15° 59'	4	15° 59'	18° 55'	5	18° 55'	23°	6	23°	27°	7	27°	30°	Width series	$T/\{(D-d)^{0.95}\}$		over	up to	B	0.50	0.68	C	0.68	0.80	D	0.80	0.88	E	0.88	1.00
	Angle series		Contact angle α																																						
		over	up to																																						
2	10°	13° 52'																																							
3	13° 52'	15° 59'																																							
4	15° 59'	18° 55'																																							
5	18° 55'	23°																																							
6	23°	27°																																							
7	27°	30°																																							
Width series	$T/\{(D-d)^{0.95}\}$																																								
	over	up to																																							
B	0.50	0.68																																							
C	0.68	0.80																																							
D	0.80	0.88																																							
E	0.88	1.00																																							
<p>(2) Diameter series</p> <table border="1"> <thead> <tr> <th rowspan="2">Diameter series</th> <th colspan="2">$D/(d^{0.77})$</th> </tr> <tr> <th>over</th> <th>up to</th> </tr> </thead> <tbody> <tr><td>B</td><td>3.40</td><td>3.80</td></tr> <tr><td>C</td><td>3.80</td><td>4.40</td></tr> <tr><td>D</td><td>4.40</td><td>4.70</td></tr> <tr><td>E</td><td>4.70</td><td>5.00</td></tr> <tr><td>F</td><td>5.00</td><td>5.60</td></tr> <tr><td>G</td><td>5.60</td><td>7.00</td></tr> </tbody> </table>	Diameter series	$D/(d^{0.77})$		over	up to	B	3.40	3.80	C	3.80	4.40	D	4.40	4.70	E	4.70	5.00	F	5.00	5.60	G	5.60	7.00	<p>[Remarks]</p> <p>1. Combine these series symbols in the listed order to make the dimension series numbers. (ex. 2BC)</p> <p>2. Bearing numbers consist of a dimension series number and a bore diameter which is added as a suffix. (ex. 2BC080 : bore diameter 80 mm)</p>																	
Diameter series		$D/(d^{0.77})$																																							
	over	up to																																							
B	3.40	3.80																																							
C	3.80	4.40																																							
D	4.40	4.70																																							
E	4.70	5.00																																							
F	5.00	5.60																																							
G	5.60	7.00																																							
Tolerances	<ul style="list-style-type: none"> · Metric series single-row tapered roller bearings as specified in JIS B 1514-1. (refer to Table 7-5 on pp. A 60 – A 62.) · Metric series double-row tapered roller bearings as specified in BAS 1002. (refer to Table 7-6 on p. A 63.) · Inch series tapered roller bearings as specified in ABMA Section 19. (refer to Table 7-7 on pp. A 64, 65.) · J series metric tapered roller bearings the tolerance is specified separately. (refer to Table 7-8 on pp. A 66, 67.) 																																								
Internal clearance	Radial internal clearance of double-row, four-row and matched pair tapered roller bearings (refer to Table 10-10 on p. A 104.)																																								
Recommended fits	<ul style="list-style-type: none"> · Metric series tapered roller bearings (classes 0, 6X and 6) (refer to Table 9-4 on pp. A 85, 86.) · Inch series tapered roller bearings (refer to Table 9-7 on pp. A 90, 91.) · J series metric tapered roller bearings (refer to Table 9-6 on pp. A 88, 89.) 																																								
Standard cage	Pressed steel cage (supplementary code : //) (Some large size bearings have a pin type cage (FP) instead.) (They are listed separately in the bearing specification table.)																																								

Allowable misalignment	Single-row tapered roller bearings : 0.000 9 rad (3') (If the misalignment exceeds this angle size, JTEKT is ready to design special bearings to order.)
Equivalent radial load	<p>■ Single-row tapered roller bearings</p> <p>Dynamic equivalent radial load $\left(\text{when } \frac{F_a}{F_r} \leq e \right) P_r = F_r$ $\left(\text{when } \frac{F_a}{F_r} > e \right) P_r = 0.4F_r + Y_1 F_a$</p> <p>Static equivalent radial load $P_{0r} = 0.5F_r + Y_0 F_a$ when $P_{0r} < F_r, P_{0r} = F_r$</p> <p>[Note] Refer to the bearing specification table for the values of axial load factors Y_1, Y_2, Y_3 and Y_0 and constant e.</p> <p>■ Double-row or four-row tapered roller bearings</p> <p>Dynamic equivalent radial load $\left(\text{when } \frac{F_a}{F_r} \leq e \right) P_r = F_r + Y_2 F_a$ $\left(\text{when } \frac{F_a}{F_r} > e \right) P_r = 0.67F_r + Y_3 F_a$</p> <p>Static equivalent radial load $P_{0r} = F_r + Y_0 F_a$</p>
[Remarks]	<p>1. When two single-row tapered roller bearings are used together facing one another, an axial component of force is produced under radial load. In this case, refer to pp. A 34, 35 for calculation of the dynamic equivalent radial load.</p> <p>2. When the load is too small, slippage occurs between the rollers and raceways, causing smearing to develop. This also occurs to matched pair bearings when the ratio of axial load to radial load exceeds the value e shown in the specification table ($F_a / F_r > e$). Consult with JTEKT on use of bearings under such conditions.</p>

Single-row tapered roller bearings
metric series

d 15 ~ 22 mm

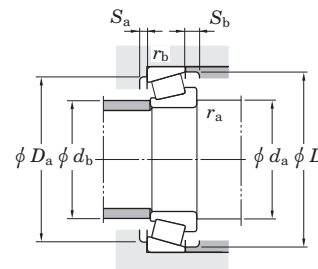
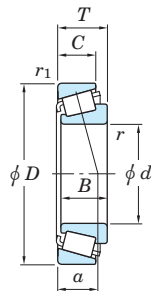

Boundary dimensions (mm)							Basic load ratings (kN)		Limiting speeds (min ⁻¹)		Bearing No. ¹⁾	Dimension series to ISO355 (Refer.)	Load center (mm) a	Mounting dimensions (mm)								Constant e	Axial load factors		(Refer.) Mass (kg)	
d	D	T	B	C	r _{min.}	r _{1 min.}	C _r	C _{0r}	Grease lub.	Oil lub.				d _a min.	d _b max.	D _a max.	D _b min.	S _a min.	S _b min.	r _a max.	r _b max.		Y ₁	Y ₀		
15	35	11.75	11	10	0.6	0.6	15.8	14.5	12 000	16 000	30202R 30302JR	—	8.3	19.5	20	30.5	29	33	2	1.7	0.6	0.6	0.32	1.88	1.04	0.054
	42	14.25	13	11	1	1	21.9	19.2	10 000	14 000		2FB	10.0	20.5	22	36.5	35	38	2	3	1	1	0.29	2.11	1.16	0.098
17	40	13.25	12	11	1	1	20.8	20.7	10 000	14 000	30203JR 32203JR	2DB	10.1	22.5	23	34.5	33	37	2	2	1	1	0.35	1.74	0.96	0.081
	40	17.25	16	14	1	1	27.4	27.5	10 000	14 000		2DD	11.4	22.5	23	34.5	33	37	2	3	1	1	0.31	1.92	1.06	0.104
	47	15.25	14	12	1	1	27.4	24.5	9 200	12 000	30303JR 30303R	2FB	11.0	22.5	25	41.5	40	42	2	3	1	1	0.29	2.11	1.16	0.133
	47	15.25	14	12	1	1	27.4	24.5	9 200	12 000		—	10.5	22.5	25	41.5	40	42	2	3	1	1	0.28	2.11	1.16	0.127
	47	20.25	19	16	1	1	31.9	29.9	9 400	13 000	32303 32303JR	—	12.4	22.5	25	41.5	39	43	2	4	1	1	0.28	2.11	1.16	0.170
	47	20.25	19	16	1	1	36.6	35.9	9 400	13 000		2FD	12.2	22.5	25	41.5	39	43	2	4	1	1	0.29	2.11	1.16	0.176
20	42	15	15	12	0.6	0.6	27.3	31.5	9 700	13 000	32004JR 57008R	3CC	10.5	24.5	25	37.5	35	39	3	3	0.6	0.6	0.37	1.60	0.88	0.102
	47	15.25	14	12	1	1	25.8	25.5	9 000	12 000		—	12.9	25.5	26	41.5	37	44	2	3	1	1	0.52	1.16	0.64	0.125
	47	15.25	14	12	1	1	27.0	27.2	8 700	12 000	30204JR 32204JR	2DB	11.8	25.5	27	41.5	39	44	2	3	1	1	0.35	1.74	0.96	0.127
	47	19.25	18	15	1	1	33.1	34.7	8 900	12 000		2DD	12.5	25.5	27	41.5	39	43	2	4	1	1	0.33	1.81	1.00	0.159
	47	19.25	18	16	1	1	33.3	37.0	9 100	12 000	32204XR 30304AC	—	15.3	25.5	25	41.5	35	45	2	3	1	1	0.55	1.10	0.60	0.170
	52	16.25	16	12	1.5	1.5	30.5	28.4	8 300	11 000		—	13.5	28.5	28	43.5	42	49	4	4	1.5	1.5	0.55	1.10	0.60	0.170
	52	16.25	16	13	1.5	1.5	36.2	35.1	8 300	11 000	30304AJR 32304CR	—	11.1	28.5	28	44	44	47	2	3	1.5	1.5	0.30	2.00	1.10	0.179
	52	22.25	21	18	1.5	1.5	41.8	44.9	8 600	12 000		—	16.5	28.5	25	43.5	37	48	3	4	1.5	1.5	0.55	1.10	0.60	0.250
	52	22.25	21	18	1.5	1.5	45.1	46.7	8 400	11 000	32304JR	2FD	14.4	28.5	27	43.5	43	47	3	4	1.5	1.5	0.30	2.00	1.10	0.244
	22	44	15	15	11.5	0.6	0.6	28.3	33.6	9 100	12 000	320/22JR T2CC022	3CC	11.0	26.5	27	39.5	38	41	3	3.5	0.6	0.6	0.40	1.51	0.83
47		17	17.5	13.5	1	1	32.7	35.9	8 700	12 000	2CC		11.3	27.5	28	41.5	40	44	4	3.5	1	1	0.33	1.79	0.99	0.138
50		15.25	14	12	1	1	29.2	28.6	8 400	11 000	302/22CR 302/22R	—	13.9	27.5	28	44.5	40	47	2	3	1	1	0.55	1.10	0.60	0.140
50		15.25	14	12	1	1	29.3	30.9	8 100	11 000		—	12.2	27.5	30	44.5	41	46	2	3	1	1	0.37	1.60	0.88	0.144
50		19.25	18	15	1	1	35.1	39.1	8 400	11 000	322/22CR 322/22R	—	15.5	27.5	28	44.5	38	47	2	4	1	1	0.55	1.10	0.60	0.170
50		19.25	18	15	1	1	36.8	41.6	8 100	11 000		—	14.0	27.5	29	44.5	41	46	2	4	1	1	0.37	1.60	0.88	0.178
56		17.25	16	13	1.5	1.5	36.3	36.6	7 700	10 000	303/22XR 303/22R	—	15.7	30.5	31	47.5	44	52	3	4	1.5	1.5	0.59	1.02	0.56	0.210
56		17.25	16	14	1.5	1.5	41.7	41.1	7 500	10 000		—	12.2	30.5	32	47.5	47	51	2	3	1.5	1.5	0.31	1.97	1.08	0.216
56		22.25	21	17	1.5	1.5	48.3	50.6	8 000	11 000	323/22CR 323/22R	—	16.9	30.5	28	47.5	41	52	3	5	1.5	1.5	0.55	1.10	0.60	0.290
56		22.25	21	18	1.5	1.5	50.6	52.7	7 600	10 000		—	14.6	30.5	31	47.5	46	51	3	4	1.5	1.5	0.31	1.97	1.08	0.273

[Note] 1) Please consult with JTEKT when using the bearings identified by suffix C. They are medium-tapered types especially designed for special purposes.

Single-row tapered roller bearings
metric series

d 25 ~ (30) mm

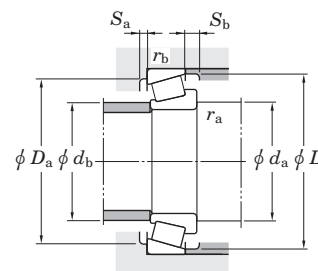
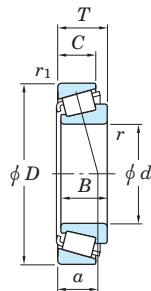

Boundary dimensions (mm)							Basic load ratings (kN)		Limiting speeds (min ⁻¹)		Bearing No. ¹⁾	Dimension series to ISO355 (Refer.)	Load center (mm) a	Mounting dimensions (mm)								Constant e	Axial load factors		(Refer.) Mass (kg)		
d	D	T	B	C	r min.	r1 min.	C _r	C _{0r}	Grease lub.	Oil lub.				d _a min.	d _b max.	D _a max.	D _b min.	S _a min.	S _b min.	r _a max.	r _b max.		Y ₁	Y ₀			
25	47	15	15	11.5	0.6	0.6	30.2	37.7	8 300	11 000	32005JR	4CC	11.8	29.5	30	42.5	40	44	3	3.5	0.6	0.6	0.43	1.39	0.77	0.118	
	47	17	17	14	0.6	0.6	33.5	42.3	8 300	11 000	33005JR	2CE	10.9	29.5	30	42.5	41	44	3	3	0.6	0.6	0.29	2.07	1.14	0.131	
	52	16.25	15	12	1	1	30.4	32.4	7 900	11 000	30205XR	—	14.9	30.5	30	46.5	41	49	2	4	1	1	0.58	1.04	0.57	0.155	
	52	16.25	15	13	1	1	31.5	33.7	7 800	10 000	30205JR	3CC	12.9	30.5	31	46.5	44	48	2	3	1	1	0.37	1.60	0.88	0.156	
	52	19.25	18	16	1	1	36.4	43.2	7 900	11 000	32205XR	—	16.2	30.5	30	46.5	40	50	2	3	1	1	0.55	1.10	0.60	0.200	
	52	19.25	18	16	1	1	39.8	44.8	7 900	11 000	32205JR	2CD	13.5	30.5	31	46.5	43	48	2	4	1	1	0.36	1.67	0.92	0.188	
	52	22	22	18	1	1	48.9	58.5	7 900	10 000	33205JR	2DE	14.1	30.5	30	46.5	43	49	4	4	1	1	0.35	1.71	0.94	0.225	
	62	18.25	17	13	1.5	1.5	39.8	42.5	5 700	8 000	30305DJR	7FB	20.4	33.5	34	53.5	47	58.5	3	5	1.5	1.5	0.83	0.73	0.40	0.269	
	62	18.25	17	14	1.5	1.5	45.0	45.8	6 700	9 000	TR0506R	—	16.3	33.5	35	53.5	50	58	3	4	1.5	1.5	0.55	1.10	0.60	0.275	
	62	18.25	17	15	1.5	1.5	48.2	46.9	6 800	9 000	30305JR	2FB	12.9	33.5	34	54	54	57	2	3	1.5	1.5	0.30	2.00	1.10	0.273	
	62	25.25	24	19	1.5	1.5	57.2	65.8	7 000	9 300	32305XR	—	18.9	33.5	33	53.5	46	58	3	6	1.5	1.5	0.55	1.10	0.60	0.390	
	62	25.25	24	20	1.5	1.5	61.2	64.1	6 900	9 100	32305JR	2FD	16.6	33.5	33	53.5	52	57	3	5	1.5	1.5	0.30	2.00	1.10	0.386	
	28	52	16	16	12	1	1	35.2	44.0	7 500	10 000	320/28JR	4CC	12.7	33.5	33	46.5	45	49	3	4	1	1	0.43	1.39	0.77	0.150
		58	17.25	16	13	1	1	38.8	41.7	7 000	9 300	302/28CR	—	16.0	33.5	34	52.5	47	55	2	4	1	1	0.55	1.10	0.60	0.205
58		17.25	16	14	1	1	38.8	42.0	7 000	9 300	302/28R	—	13.4	33.5	35	52.5	49	54	2	3	1	1	0.37	1.60	0.88	0.209	
58		20.25	19	16	1	1	44.9	54.1	7 100	9 400	322/28CR	—	17.0	33.5	33	52.5	45	55	3	4	1	1	0.55	1.10	0.60	0.255	
58		20.25	19	16	1	1	49.2	55.2	6 900	9 100	322/28R	—	15.0	33.5	35	52.5	49	54.5	2	4	1	1	0.37	1.60	0.88	0.244	
58		24	24	19	1	1	57.6	69.5	7 000	9 300	332/28JR	2DE	15.4	33.5	34	52.5	49	55	4	5	1	1	0.34	1.77	0.97	0.302	
68		19.75	18	14	1.5	1.5	51.7	50.2	6 200	8 200	303/28CR	—	17.8	36.5	37	59.5	55	64	3	4.5	1.5	1.5	0.55	1.10	0.60	0.332	
68		19.75	18	16	1.5	1.5	53.5	54.0	6 100	8 200	303/28R	—	14.9	36.5	38	59.5	58	63	2	3.5	1.5	1.5	0.32	1.88	1.04	0.345	
68		25.75	24	20	1.5	1.5	66.5	72.9	6 300	8 500	323/28CR	—	20.5	36.5	35	59.5	51	64	3	5.5	1.5	1.5	0.55	1.10	0.60	0.480	
68		25.75	24	21	1.5	1.5	69.6	75.6	6 100	8 100	323/28R	—	17.6	36.5	38	59.5	57	63	3	4.5	1.5	1.5	0.32	1.88	1.04	0.469	
30	55	17	17	13	1	1	38.2	48.0	7 000	9 400	32006JR	4CC	13.6	35.5	35	49.5	47	52	3	4	1	1	0.43	1.39	0.77	0.177	
	55	20	20	16	1	1	43.2	55.2	7 000	9 400	33006JR	2CE	13.0	35.5	36	49.5	48	52	3	4	1	1	0.29	2.06	1.13	0.203	
	62	17.25	16	13	1	1	42.3	45.1	6 500	8 700	30206CR	—	16.5	35.5	36	56.5	51	59	2	4	1	1	0.55	1.10	0.60	0.230	
	62	17.25	16	14	1	1	41.5	44.8	6 500	8 700	30206JR	3DB	14.1	35.5	37	56.5	53	57	2	3	1	1	0.37	1.60	0.88	0.236	
	62	21.25	20	16	1	1	51.7	59.0	6 600	8 900	32206XR	—	18.0	35.5	36	56.5	49	59	3	5	1	1	0.55	1.10	0.60	0.300	

[Note] 1) Please consult with JTEKT when using the bearings identified by suffix C. They are medium-tapered types especially designed for special purposes.

Single-row tapered roller bearings
metric series

d (30) ~ (35) mm

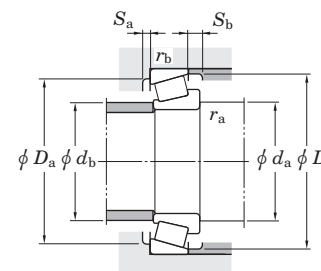
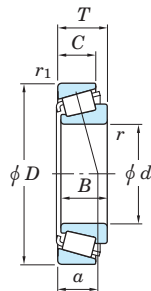

Boundary dimensions (mm)							Basic load ratings (kN)		Limiting speeds (min ⁻¹)		Bearing No. ¹⁾	Dimension series to ISO355 (Refer.)	Load center (mm) a	Mounting dimensions (mm)								Constant e	Axial load factors		(Refer.) Mass (kg)	
d	D	T	B	C	r min.	r1 min.	Cr	C0r	Grease lub.	Oil lub.				da min.	db max.	Da max.	Db min.	Sa min.	Sb min.	ra max.	rb max.		Y1	Y0		
30	62	21.25	20	17	1	1	50.7	57.9	6 500	8 700	32206JR	3DC	15.9	35.5	37	56.5	52	58	2	4	1	1	0.37	1.60	0.88	0.292
	62	25	25	19.5	1	1	66.4	79.4	6 500	8 700	33206JR	2DE	16.3	35.5	36	56.5	53	59	5	5.5	1	1	0.34	1.76	0.97	0.359
	72	20.75	19	14	1.5	1.5	50.9	54.9	4 900	6 800	30306DJR	7FB	23.7	38.5	40	63.5	55	68	3	6.5	1.5	1.5	0.83	0.73	0.40	0.400
	72	20.75	19	16	1.5	1.5	56.9	55.6	5 900	7 900	TRA0607R	—	18.6	38.5	39	63.5	58	68	3	4.5	1.5	1.5	0.55	1.10	0.60	0.405
	72	20.75	19	16	1.5	1.5	59.6	60.1	5 800	7 700	30306JR	2FB	15.7	38.5	40	63.5	62	66	3	4.5	1.5	1.5	0.31	1.90	1.05	0.411
	72	28.75	27	23	1.5	1.5	80.0	93.8	6 000	8 000	32306CR	5FD	22.0	38.5	37	63.5	54	68	3	5.5	1.5	1.5	0.55	1.10	0.60	0.610
	72	28.75	27	23	1.5	1.5	82.2	91.6	5 900	7 900	32306JR	2FD	18.9	38.5	39	63.5	59	66	3	5.5	1.5	1.5	0.31	1.90	1.05	0.588
	32	58	17	17	13	1	1	39.2	50.6	6 700	8 900	320/32JR	4CC	14.3	37.5	38	52.5	50	55	3	4	1	1	0.45	1.32	0.73
65		18.25	17	14	1	1	47.5	51.5	6 200	8 300	302/32CR	—	17.2	37.5	38	59.5	53	62	3	4	1	1	0.55	1.10	0.60	0.275
65		18.25	17	15	1	1	48.0	51.4	6 200	8 200	302/32R	—	14.9	37.5	39	59.5	55	61	3	3	1	1	0.37	1.60	0.88	0.266
65		22.25	21	17	1	1	55.8	65.1	6 300	8 400	322/32CR	—	18.7	37.5	37	59.5	51	62	3	5	1	1	0.55	1.10	0.60	0.340
65		22.25	21	18	1	1	51.6	57.7	6 200	8 200	322/32	—	16.3	37.5	40	59.5	55	61	2	4	1	1	0.37	1.60	0.88	0.330
65		26	26	20.5	1	1	71.8	86.9	6 200	8 300	332/32JR	2DE	16.9	37.5	38	59.5	55	62	5	5.5	1	1	0.35	1.73	0.95	0.404
75		21.75	20	16	1.5	1.5	63.4	66.3	5 600	7 400	303/32CR	—	19.7	40.5	42	66.5	60	70	3	5.5	1.5	1.5	0.55	1.10	0.60	0.465
75		21.75	20	18	1.5	1.5	64.4	65.6	5 500	7 300	303/32R	—	16.0	40.5	43	66.5	64	70	3	3.5	1.5	1.5	0.32	1.88	1.04	0.461
75		29.75	28	23	1.5	1.5	75.1	87.1	5 600	7 400	TR0608A	5FD	23.7	40.5	41	66.5	57	71	3	6.5	1.5	1.5	0.55	1.10	0.60	0.649
75		29.75	28	25	1.5	1.5	89.6	101	5 600	7 400	323/32R	—	19.6	40.5	42	66.5	63	69	3	4.5	1.5	1.5	0.32	1.88	1.04	0.650
35	55	14	14	11.5	0.6	0.6	26.1	36.5	6 600	8 800	32907JR-2	2BD	10.9	39.5	40	50.5	49	52	2.5	2.5	0.6	0.6	0.29	2.06	1.13	0.120
	62	18	18	14	1	1	45.5	59.4	6 200	8 200	32007JR	4CC	15.1	40.5	40	56.5	54	59	4	4	1	1	0.45	1.32	0.73	0.231
	62	21	20	16	1	1	40.8	53.8	6 200	8 200	33007	—	14.8	40.5	41	56.5	55	59	3	4	1	1	0.33	1.80	0.99	0.250
	62	21	21	17	1	1	51.3	68.0	6 200	8 200	33007JR	2CE	14.2	40.5	41	56.5	55	59	3	4	1	1	0.31	1.97	1.08	0.263
	72	18.25	17	15	1.5	1.5	52.9	56.2	5 700	7 600	30207CR	—	17.9	43.5	43	63.5	59	68	3	3	1.5	1.5	0.55	1.10	0.60	0.350
	72	18.25	17	15	1.5	1.5	55.1	60.9	5 600	7 400	30207JR	3DB	15.3	43.5	44	63.5	62	67	3	3	1.5	1.5	0.37	1.60	0.88	0.344
	72	24.25	23	19	1.5	1.5	69.0	86.6	5 700	7 600	32207-1R	—	21.1	43.5	42	63.5	56	68	3	5	1.5	1.5	0.58	1.04	0.57	0.465
	72	24.25	23	19	1.5	1.5	69.6	82.4	5 600	7 500	32207JR	3DC	18.2	43.5	43	63.5	61	67	3	5	1.5	1.5	0.37	1.60	0.88	0.453
	72	28	28	22	1.5	1.5	87.6	107	5 700	7 500	33207JR	2DE	18.4	43.5	42	63.5	61	68	5	6	1.5	1.5	0.35	1.70	0.93	0.551
	80	22.75	21	15	2	1.5	63.1	69.1	4 300	6 000	30307DJR	7FB	26.8	45	44	70	66	76.5	3	7.5	2	1.5	0.83	0.73	0.40	0.536

[Note] 1) Please consult with JTEKT when using the bearings identified by suffix C. They are medium-tapered types especially designed for special purposes.

Single-row tapered roller bearings
metric series

d (35) ~ (45) mm

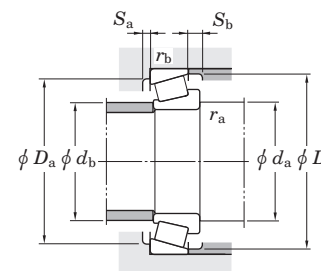
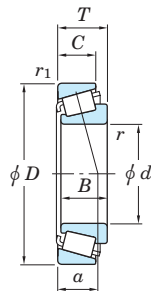

Boundary dimensions (mm)							Basic load ratings (kN)		Limiting speeds (min ⁻¹)		Bearing No. ¹⁾	Dimension series to ISO355 (Refer.)	Load center (mm) a	Mounting dimensions (mm)								Constant e	Axial load factors		(Refer.) Mass (kg)	
d	D	T	B	C	r min.	r1 min.	Cr	C0r	Grease lub.	Oil lub.				da min.	db max.	Da max.	Db min.	Sa min.	Sb min.	ra max.	rb max.		Y1	Y0		
35	80	22.75	21	18	2	1.5	69.8	77.8	5 200	7 000	30307XR	—	20.5	45	45	70	63	74	3	4.5	2	1.5	0.55	1.10	0.60	0.560
	80	22.75	21	18	2	1.5	76.2	78.9	5 200	6 900	30307JR-1	2FB	16.9	45	45	70	70	74	3	4.5	2	1.5	0.31	1.90	1.05	0.527
	80	32.75	31	25	2	1.5	96.9	123	5 200	7 000	TR0708-1R	—	23.8	45	44	70	60	75	3	7.5	2	1.5	0.47	1.27	0.70	0.830
	80	32.75	31	25	2	1.5	101	114	5 300	7 000	32307JR	2FE	20.6	45	44	70	66	74	3	7.5	2	1.5	0.31	1.90	1.05	0.776
40	62	15	15	12	0.6	0.6	33.5	48.5	5 900	7 800	32908JR	2BC	11.9	44.5	45	57.5	55	59	3	3	0.6	0.6	0.29	2.07	1.14	0.164
	68	19	19	14.5	1	1	53.5	71.4	5 600	7 400	32008JR	3CD	15.1	45.5	46	62.5	60	65	4	4.5	1	1	0.38	1.58	0.87	0.282
	68	22	22	18	1	1	60.4	84.6	5 500	7 400	33008JR	2BE	14.7	45.5	46	62.5	60	65	3	4	1	1	0.28	2.12	1.17	0.326
	75	26	26	20.5	1.5	1.5	82.2	108	5 200	6 900	33108JR	2CE	18.3	48.5	47	66.5	65	71	4	5.5	1.5	1.5	0.36	1.69	0.93	0.508
	80	19.75	18	15	1.5	1.5	61.4	67.4	5 000	6 700	30208CR	—	20.2	48.5	49	71.5	66	76	3	4.5	1.5	1.5	0.55	1.10	0.60	0.445
	80	19.75	18	16	1.5	1.5	62.9	69.2	5 000	6 700	30208JR	3DB	17.0	48.5	49	71.5	69	75	3	3.5	1.5	1.5	0.37	1.60	0.88	0.434
	80	24.75	23	19	1.5	1.5	78.5	93.1	5 000	6 700	32208CR	5DC	22.0	48.5	48	71.5	64	76	3	5.5	1.5	1.5	0.55	1.10	0.60	0.570
	80	24.75	23	19	1.5	1.5	77.7	90.8	5 000	6 600	32208JR	3DC	19.4	48.5	48	71.5	68	75	3	5.5	1.5	1.5	0.37	1.60	0.88	0.554
	80	32	32	25	1.5	1.5	108	139	5 000	6 700	33208JR	2DE	20.7	48.5	47	71.5	67	76	5	7	1.5	1.5	0.36	1.68	0.92	0.758
	85	33	32.5	28	2.5	2	114	143	4 800	6 400	T2EE040	2EE	21.9	52	48	75	70	80	5	5	2	2	0.34	1.74	0.96	0.900
	90	25.25	23	17	2	1.5	80.5	90.2	3 800	5 300	30308DJR	7FB	29.9	50	51	80	71	86.5	3	8	2	1.5	0.83	0.73	0.40	0.757
	90	25.25	23	20	2	1.5	87.3	98.5	4 600	6 100	30308XR	—	23.8	50	53	80	72	84	3	5	2	1.5	0.55	1.10	0.60	0.780
	90	25.25	23	20	2	1.5	90.6	101	4 500	6 100	30308JR	2FB	19.9	50	52	80	77	82	3	5	2	1.5	0.35	1.74	0.96	0.757
	90	35.25	33	26	2	1.5	112	138	4 700	6 200	TR0809AR	—	27.5	50	49	80	67	85	3	9	2	1.5	0.55	1.10	0.60	1.10
90	35.25	33	27	2	1.5	116	139	4 600	6 200	32308JR	2FD	24.3	50	50	80	73	82	3	8	2	1.5	0.35	1.74	0.96	1.06	
45	68	15	15	12	0.6	0.6	34.7	52.4	5 300	7 100	32909JR	2BC	12.5	49.5	50	63.5	61	64	3	3	0.6	0.6	0.32	1.88	1.04	0.190
	75	20	20	15.5	1	1	62.8	86.5	5 000	6 600	32009JR	3CC	16.5	50.5	51	69.5	67	72	4	4.5	1	1	0.39	1.53	0.84	0.354
	75	24	24	19	1	1	69.6	101	5 000	6 700	33009JR	2CE	16.4	50.5	51	69.5	67	71	4	5	1	1	0.29	2.04	1.12	0.416
	80	26	26	20.5	1.5	1.5	87.5	120	4 800	6 400	33109JR	3CE	19.4	53.5	52	71.5	69	76.5	4	5.5	1.5	1.5	0.38	1.57	0.86	0.563
	85	20.75	19	15	1.5	1.5	69.4	81.5	4 600	6 100	30209XR	—	21.1	53.5	54	76.5	71	80	4	5.5	1.5	1.5	0.55	1.10	0.60	0.500
	85	20.75	19	16	1.5	1.5	67.2	77.4	4 600	6 100	30209JR	3DB	18.9	53.5	54	76.5	74	80	3	4.5	1.5	1.5	0.40	1.48	0.81	0.502
	85	24.75	23	19	1.5	1.5	80.7	102	4 600	6 200	32209CR	—	23.0	53.5	53	76.5	69	81	3	5.5	1.5	1.5	0.55	1.10	0.60	0.625
	85	24.75	23	19	1.5	1.5	84.2	104	4 600	6 100	32209JR-1	3DC	20.3	53.5	53	76.5	73	81	3	5.5	1.5	1.5	0.40	1.48	0.81	0.597

[Note] 1) Please consult with JTEKT when using the bearings identified by suffix C. They are medium-tapered types especially designed for special purposes.

Single-row tapered roller bearings
metric series

d (45) ~ (55) mm

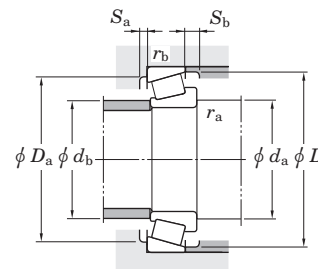
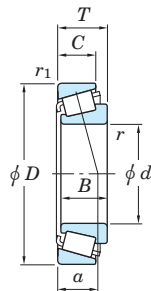

Boundary dimensions (mm)							Basic load ratings (kN)		Limiting speeds (min ⁻¹)		Bearing No. ¹⁾	Dimension series to ISO355 (Refer.)	Load center (mm) a	Mounting dimensions (mm)								Constant e	Axial load factors		(Refer.) Mass (kg)	
d	D	T	B	C	r min.	r1 min.	C _r	C _{0r}	Grease lub.	Oil lub.				d _a min.	d _b max.	D _a max.	D _b min.	S _a min.	S _b min.	r _a max.	r _b max.		Y ₁	Y ₀		
45	85	32	32	25	1.5	1.5	112	149	4 600	6 200	33209JR	3DE	21.8	53.5	52	76.5	72	81	5	7	1.5	1.5	0.39	1.56	0.86	0.818
	95	29	26.5	20	2.5	2.5	94.1	118	3 600	5 100	T7FC045	7FC	32.6	57	54	83	71	91	3	9	2	2	0.87	0.69	0.38	0.943
	95	36	35	30	2.5	2.5	140	177	4 300	5 700	T2ED045	2ED	23.8	57	55	83	80	89	6	6	2	2	0.32	1.86	1.02	1.20
	100	27.25	25	18	2	1.5	95.1	107	3 400	4 700	30309DJR	7FB	32.9	55	56	90	79	96	3	9	2	1.5	0.83	0.73	0.40	0.973
	100	27.25	25	20	2	1.5	109	119	4 100	5 500	30309CR	—	25.7	55	57	90	81	94	4	7	2	1.5	0.55	1.10	0.60	1.00
	100	27.25	25	22	2	1.5	113	128	4 100	5 400	30309JR	2FB	21.3	55	59	90	86	93	3	5	2	1.5	0.35	1.74	0.96	1.01
	100	38.25	36	29	2	1.5	145	182	4 200	5 600	32309CR	—	30.3	55	56	90	76	95	4	9	2	1.5	0.55	1.10	0.60	1.45
100	38.25	36	30	2	1.5	146	180	4 100	5 500	32309JR	2FD	26.8	55	56	90	82	93	3	8	2	1.5	0.35	1.74	0.96	1.43	
50	72	15	15	12	0.6	0.6	35.9	56.3	4 900	6 600	32910JR	2BC	13.7	54.5	55	67.5	65	69	3	3	0.6	0.6	0.34	1.76	0.97	0.195
	80	20	20	15.5	1	1	65.7	94.5	4 600	6 100	32010JR	3CC	17.7	55.5	56	74.5	72	77	4	4.5	1	1	0.42	1.42	0.78	0.389
	80	24	24	19	1	1	73.0	110	4 600	6 100	33010JR	2CE	17.4	55.5	56	74.5	72	76	4	5	1	1	0.32	1.90	1.04	0.451
	85	26	26	20	1.5	1.5	89.4	127	4 400	5 900	33110JR	3CE	20.6	58.5	56	76.5	74	81.5	4	6	1.5	1.5	0.41	1.46	0.80	0.594
	90	21.75	20	16	1.5	1.5	77.2	95.8	4 300	5 700	30210CR	—	22.7	58.5	58	81.5	76	86	4	5.5	1.5	1.5	0.55	1.10	0.60	0.590
	90	21.75	20	17	1.5	1.5	76.5	91.7	4 300	5 700	30210JR	3DB	20.1	58.5	58	81.5	79	85	3	4.5	1.5	1.5	0.42	1.43	0.79	0.566
	90	24.75	23	19	1.5	1.5	84.5	113	4 300	5 700	32210CR	—	24.0	58.5	58	81.5	74	86	3	5.5	1.5	1.5	0.55	1.10	0.60	0.675
	90	24.75	23	19	1.5	1.5	85.0	105	4 300	5 700	32210JR	3DC	20.6	58.5	58	81.5	78	85	3	5.5	1.5	1.5	0.42	1.43	0.79	0.643
	90	32	32	24.5	1.5	1.5	119	167	4 300	5 700	33210JR	3DE	23.1	58.5	57	81.5	77	86.5	5	7.5	1.5	1.5	0.41	1.45	0.80	0.887
	100	36	35	30	2.5	2.5	157	196	4 100	5 400	T2ED050	2ED	24.5	62	58	88	84	94	6	6	2	2	0.34	1.75	0.96	1.28
	105	32	29	22	3	3	113	140	3 300	4 600	T7FC050	7FC	35.9	64	59	91	78	100	4	10	2.5	2.5	0.87	0.69	0.38	1.25
	110	29.25	27	19	2.5	2	115	133	3 100	4 300	30310DJR	7FB	35.0	62	62	98	87	105	3	10	2	2	0.83	0.73	0.40	1.25
	110	29.25	27	20	2.5	2	124	143	3 700	4 900	30310CR	—	27.5	62	64	98	90	103	4	9	2	2	0.55	1.10	0.60	1.25
	110	29.25	27	23	2.5	2	137	152	3 700	4 900	30310JR	2FB	22.9	62	65	98	95	102	3	6	2	2	0.35	1.74	0.96	1.32
	110	42.25	40	33	2.5	2	171	234	3 800	5 100	32310CR	5FD	33.4	62	61	98	81	103	4	9	2	2	0.55	1.10	0.60	2.00
	110	42.25	40	33	2.5	2	176	220	3 700	5 000	32310JR	2FD	29.4	62	62	98	90	102	3	9	2	2	0.35	1.74	0.96	1.89
55	80	17	17	14	1	1	44.6	73.3	4 400	5 900	32911JR	2BC	14.5	61	61	74	72	76	3	3	1	1	0.31	1.94	1.07	0.285
	90	23	23	17.5	1.5	1.5	84.6	121	4 100	5 500	32011JR	3CC	19.8	63.5	63	81.5	81	86	4	5.5	1.5	1.5	0.41	1.48	0.81	0.569
	90	27	27	21	1.5	1.5	96.5	149	4 100	5 400	33011JR	2CE	19.3	63.5	63	81.5	81	86	5	6	1.5	1.5	0.31	1.92	1.06	0.672

[Note] 1) Please consult with JTEKT when using the bearings identified by suffix C. They are medium-tapered types especially designed for special purposes.

Single-row tapered roller bearings
metric series

d (55) ~ (60) mm

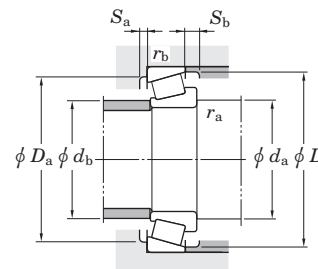
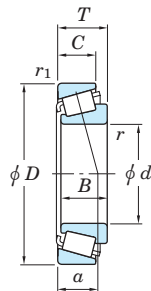

Boundary dimensions (mm)							Basic load ratings (kN)		Limiting speeds (min ⁻¹)		Bearing No. ¹⁾	Dimension series to ISO355 (Refer.)	Load center (mm) a	Mounting dimensions (mm)								Constant e	Axial load factors		(Refer.) Mass (kg)	
d	D	T	B	C	r min.	r1 min.	C _r	C _{0r}	Grease lub.	Oil lub.				d _a min.	d _b max.	D _a max.	D _b min.	S _a min.	S _b min.	r _a max.	r _b max.		Y ₁	Y ₀		
55	95	30	30	23	1.5	1.5	116	161	4 000	5 300	3311JR	3CE	22.5	63.5	62	86.5	83	91	5	7	1.5	1.5	0.37	1.60	0.88	0.868
	100	22.75	21	17	2	1.5	89.6	108	3 900	5 200	3021CR	—	24.3	65	63	90	84	95	4	5.5	2	1.5	0.55	1.10	0.60	0.750
	100	22.75	21	18	2	1.5	94.6	113	3 900	5 200	3021JR	3DB	20.7	65	64	90	88	94	4	4.5	2	1.5	0.40	1.48	0.81	0.732
	100	26.75	25	21	2	1.5	107	135	3 900	5 200	3221CR	—	25.9	65	64	90	83	96	4	5.5	2	1.5	0.55	1.10	0.60	0.875
	100	26.75	25	21	2	1.5	107	133	3 900	5 200	3221JR-1	3DC	23.0	65	63	90	87	95	4	5.5	2	1.5	0.40	1.48	0.81	0.863
	100	35	35	27	2	1.5	142	189	3 900	5 200	3321JR	3DE	25.3	65	62	90	85	96	6	8	2	1.5	0.40	1.50	0.83	1.18
	115	34	31	23.5	3	3	129	164	3 000	4 200	T7FC055	7FC	38.6	69	65	101	86	109	4	10.5	2.5	2.5	0.87	0.69	0.38	1.59
	120	31.5	29	21	2.5	2	129	148	2 900	4 000	3031DJR	7FB	38.4	67	68	108	94	113	4	10.5	2	2	0.83	0.73	0.40	1.59
	120	31.5	29	22	2.5	2	144	161	3 400	4 500	3031CR	—	29.8	67	70	108	97	112	4.5	9.5	2	2	0.55	1.10	0.60	1.58
	120	31.5	29	25	2.5	2	149	170	3 300	4 500	3031JR	2FB	25.5	67	71	108	104	111	4	6.5	2	2	0.35	1.74	0.96	1.65
	120	45.5	43	35	2.5	2	184	247	3 400	4 600	32311C	5FD	35.9	67	67	108	90	113	4	10	2	2	0.55	1.10	0.60	2.45
	120	45.5	43	35	2.5	2	171	203	3 400	4 500	32311J	2FD	32.4	67	68	108	99	111	4	10.5	2	2	0.35	1.74	0.96	2.24
	120	45.5	43	35	2.5	2	200	250	3 400	4 500	32311JR	2FD	32.4	67	68	108	99	111	4	10.5	2	2	0.35	1.74	0.96	2.38
	60	85	17	17	14	1	1	46.2	78.2	4 100	5 500	32912JR	2BC	15.6	65.5	66	79.5	77	81	3	3	1	1	0.33	1.81	1.00
95		23	23	17.5	1.5	1.5	86.1	127	3 900	5 200	32012JR	4CC	21.0	68.5	67	86.5	85	91	4	5.5	1.5	1.5	0.43	1.39	0.77	0.621
95		27	27	21	1.5	1.5	101	162	3 900	5 200	33012JR	2CE	20.1	68.5	67	86.5	85	90	5	6	1.5	1.5	0.33	1.83	1.01	0.719
100		30	30	23	1.5	1.5	118	170	3 700	5 000	33112JR	3CE	23.7	68.5	67	91.5	88	96	5	7	1.5	1.5	0.40	1.51	0.83	0.923
110		23.75	22	17	2	1.5	102	123	3 500	4 700	30212CR	—	26.2	70	70	100	93	104	4	6.5	2	1.5	0.55	1.10	0.60	0.930
110		23.75	22	19	2	1.5	106	127	3 500	4 700	30212JR	3EB	21.9	70	70	100	96	103	4	4.5	2	1.5	0.40	1.48	0.81	0.945
110		29.75	28	22	2	1.5	128	164	3 600	4 700	32212CR	—	28.6	70	68	100	91	105	4	7.5	2	1.5	0.55	1.10	0.60	1.20
110		29.75	28	24	2	1.5	132	167	3 500	4 700	32212JR	3EC	25.1	70	69	100	95	104	4	5.5	2	1.5	0.40	1.48	0.81	1.19
110		38	38	29	2	1.5	174	239	3 600	4 700	33212JR	3EE	27.2	70	69	100	93	105	6	9	2	1.5	0.40	1.48	0.82	1.57
115		39	38	31	4	2.5	158	227	3 400	4 600	T5ED060	5ED	32.4	78	70	103	92	110	5	8	3	2	0.53	1.13	0.62	1.81
115		40	39	33	2.5	2.5	183	242	3 400	4 600	T2EE060	2EE	27.6	72	70	103	98	109	6	7	2	2	0.33	1.80	0.99	1.80
125		37	33.5	26	3	3	153	194	2 800	3 900	T7FC060	7FC	40.8	74	71	111	94	119	4	11	2.5	2.5	0.82	0.73	0.40	2.03
130		33.5	31	22	3	2.5	153	179	2 600	3 700	30312DJR	7FB	40.8	74	73	118	103	124	4	11.5	2.5	2	0.83	0.73	0.40	2.01
130		33.5	31	23	3	2.5	169	196	3 100	4 200	30312CR	—	31.9	74	75	118	105	121	5	10.5	2.5	2	0.55	1.10	0.60	1.99

[Note] 1) Please consult with JTEKT when using the bearings identified by suffix C. They are medium-tapered types especially designed for special purposes.

Single-row tapered roller bearings
metric series

d (60) ~ (70) mm

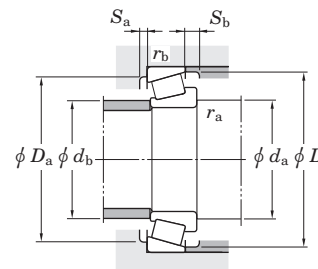
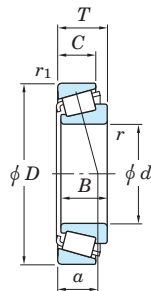

Boundary dimensions (mm)							Basic load ratings (kN)		Limiting speeds (min ⁻¹)		Bearing No. ¹⁾	Dimension series to ISO355 (Refer.)	Load center (mm) a	Mounting dimensions (mm)								Constant e	Axial load factors		(Refer.) Mass (kg)	
d	D	T	B	C	r min.	r1 min.	Cr	C0r	Grease lub.	Oil lub.				da min.	db max.	Da max.	Db min.	Sa min.	Sb min.	ra max.	rb max.		Y1	Y0		
60	130	33.5	31	26	3	2.5	173	201	3 100	4 100	30312JR	2FB	26.9	74	77	118	112	120	4	7.5	2.5	2	0.35	1.74	0.96	2.08
	130	48.5	46	37	3	2.5	229	310	3 200	4 300	32312CR	5FD	38.3	74	73	118	98	122	5	11	2.5	2	0.55	1.10	0.60	3.15
	130	48.5	46	37	3	2.5	221	275	3 100	4 200	32312J	2FD	32.3	74	74	118	107	120	4	11.5	2.5	2	0.35	1.74	0.96	2.87
	130	48.5	46	37	3	2.5	244	315	3 100	4 200	32312JR	2FD	32.3	74	74	118	107	120	4	11.5	2.5	2	0.35	1.74	0.96	2.99
65	90	17	17	14	1	1	47.4	83.1	3 900	5 200	32913JR	2BC	16.8	70.5	70	84.5	81	86	3	3	1	1	0.35	1.70	0.93	0.327
	100	23	23	17.5	1.5	1.5	90.0	137	3 600	4 800	32013JR	4CC	22.5	73.5	72	91.5	90	97	4	5.5	1.5	1.5	0.46	1.31	0.72	0.664
	100	27	27	21	1.5	1.5	103	169	3 600	4 800	33013JR	2CE	21.1	73.5	72	91.5	89	96	5	6	1.5	1.5	0.35	1.72	0.95	0.762
	110	34	34	26.5	1.5	1.5	152	223	3 400	4 600	33113JR	3DE	25.9	73.5	73	101.5	96	106	6	7.5	1.5	1.5	0.39	1.55	0.85	1.33
	120	24.75	23	18	2	1.5	116	139	3 200	4 300	30213CR	—	28.1	75	77	110	102	114	4	6.5	2	1.5	0.55	1.10	0.60	1.15
	120	24.75	23	20	2	1.5	128	156	3 200	4 300	30213JR	3EB	24.2	75	77	110	106	113	4	4.5	2	1.5	0.40	1.48	0.81	1.18
	120	32.75	31	24	2	1.5	151	198	3 200	4 300	32213CR	—	31.3	75	75	110	99	114	4	8.5	2	1.5	0.55	1.10	0.60	1.55
	120	32.75	31	27	2	1.5	157	203	3 200	4 300	32213JR	3EC	26.6	75	76	110	104	115	4	5.5	2	1.5	0.40	1.48	0.81	1.58
	120	39	38	31	4	2.5	151	232	3 200	4 300	T5ED065	5ED	34.1	83	75	108	96	115	5	8	3	2	0.56	1.07	0.59	1.93
	120	41	41	32	2	1.5	200	277	3 200	4 300	33213JR	3EE	30.0	75	74	110	102	115	7	9	2	1.5	0.39	1.54	0.85	2.02
	130	37	33.5	26	3	3	148	211	2 600	3 600	T7FC065	7FC	44.4	79	78	116	98	124	4	11	2.5	2.5	0.87	0.69	0.38	2.17
	140	36	33	23	3	2.5	176	209	2 400	3 400	30313DJR	7GB	44.3	79	79	128	111	133	4	13	2.5	2	0.83	0.73	0.40	2.44
	140	36	33	25	3	2.5	193	227	2 900	3 900	30313CR	—	34.3	79	81	128	113	130	5	11	2.5	2	0.55	1.10	0.60	2.44
	140	36	33	28	3	2.5	204	239	2 800	3 800	30313JR	2GB	29.3	79	83	128	122	130	4	8	2.5	2	0.35	1.74	0.96	2.56
	140	51	48	39	3	2.5	258	361	2 900	3 900	32313CR	5GD	40.9	79	79	128	106	131	5	12	2.5	2	0.55	1.10	0.60	3.85
	140	51	48	39	3	2.5	250	312	2 900	3 900	32313J	2GD	34.7	79	80	128	117	130	4	12	2.5	2	0.35	1.74	0.96	3.49
140	51	48	39	3	2.5	276	357	2 900	3 900	32313JR	2GD	34.7	79	80	128	117	130	4	12	2.5	2	0.35	1.74	0.96	3.64	
70	100	20	20	16	1	1	71.0	115	3 500	4 700	32914JR	2BC	17.8	75.5	77	94.5	91	96	4	4	1	1	0.32	1.90	1.05	0.496
	110	25	25	19	1.5	1.5	108	163	3 300	4 400	32014JR	4CC	23.6	78.5	78	101.5	98	105	5	6	1.5	1.5	0.43	1.38	0.76	0.884
	110	31	31	25.5	1.5	1.5	134	208	3 300	4 400	33014JR	2CE	22.1	78.5	78	101.5	99	105	5	5.5	1.5	1.5	0.28	2.11	1.16	1.09
	120	37	37	29	2	1.5	181	266	3 100	4 200	33114JR	3DE	28.0	80	79	110	104	115	6	8	2	1.5	0.38	1.58	0.87	1.71
	125	26.25	24	19	2	1.5	126	158	3 000	4 000	30214CR	—	29.9	80	82	116.5	107	119	4	7	2	1.5	0.55	1.10	0.60	1.30
	125	26.25	24	21	2	1.5	138	173	3 100	4 100	30214JR	3EB	25.9	80	81	116.5	110	118	4	5	2	1.5	0.42	1.43	0.79	1.32

[Note] 1) Please consult with JTEKT when using the bearings identified by suffix C. They are medium-tapered types especially designed for special purposes.

Single-row tapered roller bearings
metric series

d (70) ~ (75) mm

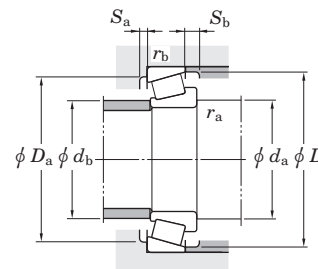
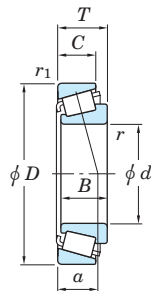

Boundary dimensions (mm)							Basic load ratings (kN)		Limiting speeds (min ⁻¹)		Bearing No. ¹⁾	Dimension series to ISO355 (Refer.)	Load center (mm) a	Mounting dimensions (mm)								Constant e	Axial load factors		(Refer.) Mass (kg)		
d	D	T	B	C	r min.	r1 min.	C _r	C _{0r}	Grease lub.	Oil lub.				d _a min.	d _b max.	D _a max.	D _b min.	S _a min.	S _b min.	r _a max.	r _b max.		Y ₁	Y ₀			
70	125	33.25	31	24	2	1.5	157	212	3 100	4 100	32214CR	—	32.6	80	80	116.5	104	120	4	9.5	2	1.5	0.55	1.10	0.60	1.65	
	125	33.25	31	27	2	1.5	169	225	3 100	4 100	32214JR	3EC	29.2	80	80	116.5	108	119	4	6	2	1.5	0.42	1.43	0.79	1.71	
	125	41	41	32	2	1.5	206	294	3 100	4 100	33214JR	3EE	31.2	80	79	116.5	107	120	7	9	2	1.5	0.41	1.47	0.81	2.16	
	130	43	42	35	3	2.5	233	319	3 000	4 000	T2ED070	2ED	30.2	84	81	118	111	123	1	1	2.5	2	0.33	1.80	0.99	2.48	
	140	39	35.5	27	3	3	177	242	2 400	3 400	T7FC070	7FC	46.5	84	82	126	106	133	5	12	2.5	2.5	0.87	0.69	0.38	2.64	
	140	52	51	43	5	3	264	382	2 900	3 800	T4FE070	4FE	37.7	92	82	126	111	133	7	9	4	2.5	0.45	1.34	0.74	3.69	
	150	38	35	25	3	2.5	197	235	2 300	3 200	30314DJR	7GB	47.1	84	84	138	118	142	4	13	2.5	2	0.83	0.73	0.40	2.97	
	150	38	35	30	3	2.5	224	256	2 700	3 600	30314CR	—	37.0	84	87	138	123	141	6	8	2.5	2	0.55	1.10	0.60	3.10	
	150	38	35	30	3	2.5	230	273	2 600	3 500	30314JR	2GB	30.5	84	89	138	130	140	4	8	2.5	2	0.35	1.74	0.96	3.08	
	150	54	51	42	3	2.5	257	315	2 700	3 600	32314	—	37.0	84	86	138	125	140	4	12	2.5	2	0.35	1.73	0.95	4.11	
	150	54	51	42	3	2.5	297	391	2 700	3 600	32314C	5GD	44.4	84	84	138	115	142	5	12	2.5	2	0.55	1.10	0.60	4.50	
	150	54	51	42	3	2.5	317	414	2 700	3 600	32314JR	2GD	37.4	84	86	138	125	140	4	12	2.5	2	0.35	1.74	0.96	4.50	
	75	105	20	20	16	1	1	73.6	123	3 300	4 400	32915JR	2BC	18.9	80.5	81	99.5	96	101	4	4	1	1	0.33	1.80	0.99	0.526
		115	25	25	19	1.5	1.5	110	169	3 100	4 200	32015JR	4CC	25.1	83.5	83	106.5	103	110	5	6	1.5	1.5	0.46	1.31	0.72	0.930
115		31	31	25.5	1.5	1.5	141	225	3 200	4 200	33015JR	2CE	22.9	83.5	83	106.5	104	110	6	5.5	1.5	1.5	0.30	2.01	1.11	1.16	
125		37	37	29	2	1.5	186	280	3 000	4 000	33115JR	3DE	29.3	85	84	116.5	109	120	6	8	2	1.5	0.40	1.51	0.83	1.84	
130		27.25	25	20	2	1.5	136	178	2 900	3 800	30215CR	—	31.0	85	87	121.5	111	124	5	7	2	1.5	0.55	1.10	0.60	1.40	
130		27.25	25	22	2	1.5	142	181	2 900	3 900	30215JR	4DB	27.6	85	86	121.5	115	124	4	5	2	1.5	0.44	1.38	0.76	1.42	
130		33.25	31	24	2	1.5	163	225	2 900	3 900	32215CR	—	33.7	85	85	121.5	109	125	4	9	2	1.5	0.55	1.10	0.60	1.75	
130		33.25	31	27	2	1.5	174	234	2 900	3 900	32215JR	4DC	30.2	85	85	121.5	114	125	4	6	2	1.5	0.44	1.38	0.76	1.77	
130		41	41	31	2	1.5	212	310	2 900	3 900	33215JR	3EE	32.5	85	83	121.5	111	125	7	10	2	1.5	0.43	1.40	0.77	2.26	
150		42	38	29	3	3	191	270	2 200	3 100	T7FC075	7FC	50.6	89	89	136	114	143	5	13	2.5	2.5	0.87	0.69	0.38	3.24	
160		40	37	26	3	2.5	213	254	2 100	2 900	30315DJR	7GB	49.9	89	91	148	127	151	6	14	2.5	2	0.83	0.73	0.40	3.45	
160		40	37	26	3	2.5	222	266	2 100	2 900	30315DR	—	48.8	89	91	148	127	151	6	14	2.5	2	0.81	0.74	0.41	3.48	
160		40	37	31	3	2.5	248	296	2 500	3 400	30315CR	—	39.2	89	94	148	130	150	6	9	2.5	2	0.55	1.10	0.60	3.80	
160		40	37	31	3	2.5	260	311	2 500	3 300	30315JR	2GB	32.5	89	95	148	139	149	4	9	2.5	2	0.35	1.74	0.96	3.65	
160		40	37	31	3	2.5	251	298	2 500	3 300	30315R	—	31.9	89	95	148	139	149	4	9	2.5	2	0.35	1.73	0.95	3.52	

[Note] 1) Please consult with JTEKT when using the bearings identified by suffix C. They are medium-tapered types especially designed for special purposes.

Single-row tapered roller bearings
metric series

d (75) ~ (85) mm

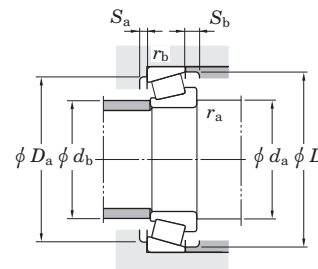
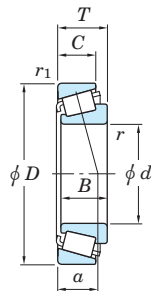

Boundary dimensions (mm)							Basic load ratings (kN)		Limiting speeds (min ⁻¹)		Bearing No. ¹⁾	Dimension series to ISO355 (Refer.)	Load center (mm) a	Mounting dimensions (mm)								Constant e	Axial load factors		(Refer.) Mass (kg)	
d	D	T	B	C	r min.	r1 min.	Cr	C0r	Grease lub.	Oil lub.				da min.	db max.	Da max.	Db min.	Sa min.	Sb min.	ra max.	rb max.		Y1	Y0		
75	160	58	55	43	3	2.5	357	474	2 500	3 400	32315CR	—	46.6	89	90	148	125	154	6	15	2.5	2	0.55	1.10	0.60	5.50
	160	58	55	45	3	2.5	363	481	2 500	3 300	32315JR	2GD	40.0	89	91	148	133	149	4	13	2.5	2	0.35	1.74	0.96	5.41
	160	58	55	45	3	2.5	340	444	2 500	3 300	32315R	—	39.5	89	91	148	133	149	4	13	2.5	2	0.35	1.73	0.95	5.30
80	110	20	20	16	1	1	76.1	131	3 100	4 200	32916JR	2BC	20.1	85.5	86	104.5	101	106	4	4	1	1	0.35	1.71	0.94	0.556
	125	29	29	22	1.5	1.5	147	225	2 900	3 900	32016JR	3CC	26.7	88.5	89	116.5	112	120	6	7	1.5	1.5	0.42	1.42	0.78	1.32
	125	36	36	29.5	1.5	1.5	173	288	2 900	3 900	33016JR	2CE	25.1	88.5	90	116.5	112	119	6	6.5	1.5	1.5	0.28	2.16	1.19	1.63
	130	37	37	29	2	1.5	191	294	2 800	3 800	33116JR	3DE	30.5	90	89	121.5	114	126	6	8	2	1.5	0.42	1.44	0.79	1.93
	140	28.25	26	22	2.5	2	161	202	2 700	3 600	30216JR	3EB	28.6	92	91	130	124	132	4	6	2	2	0.42	1.43	0.79	1.72
	140	35.25	33	28	2.5	2	203	271	2 700	3 600	32216JR	3EC	31.7	92	90	130	122	134	4	7	2	2	0.42	1.43	0.79	2.17
	140	46	46	35	2.5	2	250	371	2 700	3 600	33216JR	3EE	35.7	92	89	130	119	135	7	11	2	2	0.43	1.41	0.78	2.99
	145	46	45	38	3	2.5	266	381	2 600	3 500	T2ED080	2ED	32.7	94	92	133	125	137	7	8	2.5	2	0.32	1.88	1.03	3.20
	170	42.5	39	27	3	2.5	236	282	2 000	2 800	30316DJR	7GB	53.5	94	97	158	134	159	6	15.5	2.5	2	0.83	0.73	0.40	4.12
	170	42.5	39	33	3	2.5	294	355	2 300	3 100	30316JR	2GB	34.8	94	102	158	148	159	4	9.5	2.5	2	0.35	1.74	0.96	4.46
	170	42.5	39	33	3	2.5	277	330	2 300	3 100	30316R	—	33.9	94	102	158	148	159	4	9.5	2.5	2	0.35	1.73	0.95	4.26
	170	61.5	58	48	3	2.5	347	440	2 300	3 100	32316J	2GD	43.5	94	98	158	142	159	4	13.5	2.5	2	0.35	1.74	0.96	6.04
	170	61.5	58	48	3	2.5	383	503	2 300	3 100	32316JR	2GD	43.5	94	98	158	142	159	4	13.5	2.5	2	0.35	1.74	0.96	6.31
85	120	23	23	18	1.5	1.5	97.1	165	2 900	3 900	32917JR	2BC	21.2	93.5	93	111.5	109	115	5	5	1.5	1.5	0.33	1.83	1.01	0.794
	130	29	29	22	1.5	1.5	150	234	2 800	3 700	32017JR	4CC	28.0	93.5	94	121.5	117	125	6	7	1.5	1.5	0.44	1.36	0.75	1.38
	130	36	36	29.5	1.5	1.5	177	300	2 800	3 700	33017JR	2CE	26.3	93.5	94	121.5	118	125	6	6.5	1.5	1.5	0.29	2.06	1.13	1.72
	140	41	41	32	2.5	2	224	346	2 600	3 500	33117JR	3DE	33.2	97	95	130	122	135	7	9	2	2	0.41	1.48	0.81	2.43
	150	30.5	28	24	2.5	2	182	231	2 500	3 400	30217JR	3EB	30.4	97	97	140	132	141	5	6.5	2	2	0.42	1.43	0.79	2.17
	150	38.5	36	30	2.5	2	232	315	2 500	3 400	32217JR	3EC	34.2	97	96	140	130	142	5	8.5	2	2	0.42	1.43	0.79	2.80
	150	49	49	37	2.5	2	294	439	2 500	3 400	33217JR	3EE	37.1	97	95	140	128	144	7	12	2	2	0.42	1.43	0.79	3.63
	180	44.5	41	28	4	3	231	265	1 900	2 600	30317D	—	56.0	103	103	166	143	169	6	16.5	3	2.5	0.81	0.74	0.41	4.54
	180	44.5	41	28	4	3	263	317	1 900	2 600	30317DJR	7GB	56.3	103	103	166	143	169	6	16.5	3	2.5	0.83	0.73	0.40	4.81
	180	44.5	41	34	4	3	316	384	2 200	2 900	30317JR	2GB	36.0	103	107	166	156	167	5	10.5	3	2.5	0.35	1.74	0.96	5.15
	180	44.5	41	34	4	3	305	367	2 200	2 900	30317R	—	35.8	103	107	166	156	167	5	10.5	3	2.5	0.35	1.73	0.95	4.97

[Note] 1) Please consult with JTEKT when using the bearings identified by suffix C. They are medium-tapered types especially designed for special purposes.

Single-row tapered roller bearings
metric series

d (85) ~ 95 mm

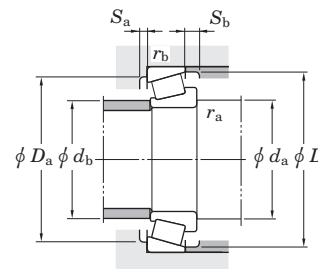
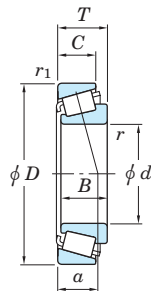

Boundary dimensions (mm)							Basic load ratings (kN)		Limiting speeds (min ⁻¹)		Bearing No.	Dimension series to ISO355 (Refer.)	Load center (mm) a	Mounting dimensions (mm)								Constant e	Axial load factors		(Refer.) Mass (kg)	
d	D	T	B	C	r min.	r1 min.	Cr	C0r	Grease lub.	Oil lub.				da min.	db max.	Da max.	Db min.	Sa min.	Sb min.	ra max.	rb max.		Y1	Y0		
85	180	63.5	60	49	4	3	439	587	2 200	3 000	32317JR	2GD	43.8	103	103	166	150	167	5	14.5	3	2.5	0.35	1.74	0.96	7.42
90	125	23	23	18	1.5	1.5	101	175	2 800	3 700	32918JR	2BC	22.3	98.5	97	116.5	114	120	5	5	1.5	1.5	0.34	1.75	0.96	0.834
	140	32	32	24	2	1.5	178	276	2 600	3 500	32018JR	3CC	29.8	100	100	131.5	125	134	6	8	2	1.5	0.42	1.42	0.78	1.80
	140	39	39	32.5	2	1.5	221	367	2 600	3 400	33018JR	2CE	27.1	100	100	131.5	127	135	7	6.5	2	1.5	0.27	2.23	1.23	2.22
	150	45	45	35	2.5	2	258	413	2 500	3 300	33118JR	3DE	35.4	102	100	140	130	144	7	10	2	2	0.40	1.51	0.83	3.13
	155	46	46	38	3	3	273	405	2 400	3 200	T2ED090	2ED	33.5	104	102	141	135	147	7	8	2.5	2.5	0.33	1.84	1.01	3.47
	160	32.5	30	26	2.5	2	204	261	2 400	3 200	30218JR	3FB	32.6	102	103	150	140	150	5	6.5	2	2	0.42	1.43	0.79	2.65
	160	42.5	40	34	2.5	2	263	362	2 400	3 200	32218JR	3FC	37.0	102	102	150	138	152	5	8.5	2	2	0.42	1.43	0.79	3.47
	160	55	55	42	2.5	2	343	527	2 400	3 200	33218JR	3FE	40.8	102	101	150	135	154	9	13	2	2	0.42	1.43	0.78	4.76
	190	46.5	43	30	4	3	288	350	1 700	2 400	30318DJR	7GB	59.6	108	109	176	151	179	6	16.5	3	2.5	0.83	0.73	0.40	5.57
	190	46.5	43	30	4	3	282	336	1 700	2 400	30318DR	—	59.1	108	109	176	151	179	6	16.5	3	2.5	0.81	0.74	0.41	5.60
	190	46.5	43	36	4	3	345	420	2 100	2 700	30318JR	2GB	38.1	108	113	176	165	177	5	10.5	3	2.5	0.35	1.74	0.96	6.04
	190	46.5	43	36	4	3	336	407	2 100	2 700	30318R	—	37.2	108	113	176	165	177	5	10.5	3	2.5	0.35	1.73	0.95	5.78
190	67.5	64	53	4	3	461	614	2 100	2 800	32318JR	2GD	46.6	108	108	176	157	177	5	14.5	3	2.5	0.35	1.74	0.96	8.61	
95	130	23	23	18	1.5	1.5	104	186	2 600	3 500	32919JR	2BC	23.5	103.5	102	121.5	119	125	5	5	1.5	1.5	0.36	1.68	0.92	0.876
	145	32	32	24	2	1.5	182	287	2 500	3 300	32019JR	4CC	31.2	105	105	136.5	130	140	6	8	2	1.5	0.44	1.36	0.75	1.88
	145	39	39	32.5	2	1.5	226	382	2 500	3 300	33019JR	2CE	27.8	105	104	136.5	131	139	7	6.5	2	1.5	0.28	2.16	1.19	2.31
	160	46	46	38	3	3	281	427	2 300	3 100	T2ED095	2ED	34.6	109	107	146	140	152	7	8	2.5	2.5	0.34	1.77	0.97	3.62
	160	49	49	38	2.5	2	304	473	2 300	3 100	33119JR	3EE	37.3	107	106	150	138	154	8	11	2	2	0.39	1.54	0.85	3.89
	170	34.5	32	27	3	2.5	231	299	2 200	3 000	30219JR	3FB	34.9	109	110	158	149	159	5	7.5	2.5	2	0.42	1.43	0.79	3.20
	170	45.5	43	37	3	2.5	311	439	2 200	3 000	32219JR	3FC	38.9	109	108	158	145	161	5	8.5	2.5	2	0.42	1.43	0.79	4.34
	170	58	58	44	3	2.5	374	582	2 200	2 900	33219JR	3FE	42.8	109	107	158	144	163	9	14	2.5	2	0.41	1.47	0.81	5.66
	200	49.5	45	32	4	3	319	391	1 700	2 300	30319DJR	7GB	62.7	113	113	186	157	187	6	17.5	3	2.5	0.83	0.73	0.40	6.68
	200	49.5	45	38	4	3	317	368	2 000	2 600	30319	—	39.8	113	118	186	172	186	5	11.5	3	2.5	0.35	1.73	0.95	6.32
	200	49.5	45	38	4	3	372	455	2 000	2 600	30319JR	2GB	40.8	113	118	186	172	186	5	11.5	3	2.5	0.35	1.74	0.96	6.96
	200	71.5	67	55	4	3	427	544	2 000	2 600	32319	—	49.1	113	115	186	166	186	5	16.5	3	2.5	0.35	1.73	0.95	9.35
200	71.5	67	55	4	3	517	695	2 000	2 600	32319JR	2GD	49.8	113	115	186	166	186	5	16.5	3	2.5	0.35	1.74	0.96	10.1	

Single-row tapered roller bearings
metric series

d 100 ~ (105) mm

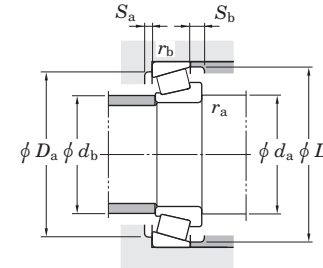
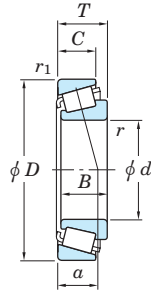

Boundary dimensions (mm)							Basic load ratings (kN)		Limiting speeds (min ⁻¹)		Bearing No.	Dimension series to ISO355 (Refer.)	Load center (mm) <i>a</i>	Mounting dimensions (mm)								Constant <i>e</i>	Axial load factors		(Refer.) Mass (kg)	
<i>d</i>	<i>D</i>	<i>T</i>	<i>B</i>	<i>C</i>	<i>r</i> min.	<i>r</i> ₁ min.	<i>C</i> _r	<i>C</i> _{0r}	Grease lub.	Oil lub.				<i>d</i> _a min.	<i>d</i> _b max.	<i>D</i> _a max.	<i>D</i> _b min.	<i>S</i> _a min.	<i>S</i> _b min.	<i>r</i> _a max.	<i>r</i> _b max.		<i>Y</i> ₁	<i>Y</i> ₀		
100	140	25	25	20	1.5	1.5	126	217	2 400	3 300	32920JR	2CC	24.0	109	108	131	128	135	5	5	1.5	1.5	0.33	1.82	1.00	1.19
	145	24	22.5	17.5	3	3	116	167	2 400	3 200	T4CB100	4CB	29.9	112	109	133	132	140	4	6.5	2.5	2.5	0.47	1.27	0.70	1.12
	150	32	32	24	2	1.5	185	298	2 400	3 200	32020JR	4CC	32.6	110	109	141	134	144	6	8	2	1.5	0.46	1.31	0.72	1.95
	150	39	39	32.5	2	1.5	231	397	2 400	3 200	33020JR	2CE	28.6	110	108	141	135	143	7	6.5	2	1.5	0.29	2.09	1.15	2.40
	165	47	46	39	3	3	293	458	2 200	3 000	T2EE100	2EE	35.1	114	112	151	145	157	7	8	2.5	2.5	0.32	1.88	1.04	3.86
	165	52	52	40	2.5	2	325	523	2 200	3 000	33120JR	3EE	40.1	112	111	155	142	159	8	12	2	2	0.41	1.48	0.81	4.29
	180	37	34	29	3	2.5	258	338	2 100	2 800	30220JR	3FB	36.8	114	116	168	157	168	5	8	2.5	2	0.42	1.43	0.79	3.83
	180	49	46	39	3	2.5	347	495	2 100	2 800	32220JR	3FC	42.1	114	114	168	154	171	5	10	2.5	2	0.42	1.43	0.79	5.21
	180	63	63	48	3	2.5	431	680	2 100	2 800	32320JR	3FE	45.7	114	112	168	151	172	10	15	2.5	2	0.40	1.48	0.82	6.92
	215	51.5	47	34	4	3	318	374	1 500	2 100	30320D	—	65.9	118	121	201	183	204	5	17	3	2.5	0.81	0.74	0.41	8.02
	215	51.5	47	39	4	3	344	400	1 800	2 400	30320	—	41.4	118	127	201	184	200	6	12.5	3	2.5	0.35	1.73	0.95	7.76
	215	51.5	47	39	4	3	422	521	1 800	2 400	30320JR	2GB	42.7	118	127	201	184	200	6	12.5	3	2.5	0.35	1.74	0.96	8.49
	215	56.5	51	35	4	3	373	459	1 500	2 200	31320JR	7GB	67.7	118	120	201	183	202	6	17.5	3	2.5	0.83	0.73	0.40	8.72
	215	77.5	73	60	4	3	491	637	1 800	2 400	32320	—	52.6	118	123	201	177	200	8	17.5	3	2.5	0.35	1.73	0.95	12.2
	215	77.5	73	60	4	3	579	783	1 800	2 400	32320JR	2GD	53.9	118	123	201	177	200	8	17.5	3	2.5	0.35	1.74	0.96	13.0
	105	145	25	25	20	1.5	1.5	128	224	2 400	3 100	32921JR	2CC	25.1	113.5	113	136.5	133	140	5	5	1.5	1.5	0.34	1.75	0.96
160		35	35	26	2.5	2	215	344	2 200	3 000	32021JR	4DC	34.5	117	116	150	143	154	6	9	2	2	0.44	1.35	0.74	2.45
160		43	43	34	2.5	2	267	461	2 200	3 000	33021JR	2DE	30.9	117	116	150	145	153	7	9	2	2	0.28	2.12	1.17	3.08
175		56	56	44	2.5	2	360	607	2 100	2 800	33121JR	3EE	43.2	117	116	165	150	169	9	12	2	2	0.40	1.48	0.82	5.33
190		39	36	30	3	2.5	288	380	2 000	2 600	30221JR	3FB	39.0	119	122	178	165	178	6	9	2.5	2	0.42	1.43	0.79	4.49
190		53	50	43	3	2.5	392	567	2 000	2 700	32221JR	3FC	44.8	119	120	178	161	180	6	10	2.5	2	0.42	1.43	0.79	6.37
190		68	68	52	3	2.5	497	790	2 000	2 600	33221JR	3FE	48.8	119	117	178	159	182	10	16	2.5	2	0.40	1.49	0.82	8.43
225		53.5	49	36	4	3	339	396	1 400	2 000	30321D	—	69.1	123	127	211	193	209	6	17	3	2.5	0.81	0.74	0.41	8.76
225		53.5	49	41	4	3	371	432	1 700	2 300	30321	—	43.1	123	132	211	193	209	7	12.5	3	2.5	0.35	1.73	0.95	8.74
225		53.5	49	41	4	3	464	578	1 700	2 300	30321JR	2GB	44.1	123	132	211	193	209	7	12.5	3	2.5	0.35	1.74	0.96	9.73
225		58	53	36	4	3	397	489	1 500	2 100	31321JR	7GB	70.3	123	126	211	193	211	6	18	3	2.5	0.83	0.73	0.40	9.72
225		81.5	77	63	4	3	543	707	1 800	2 300	32321	—	55.7	123	128	211	185	209	8	18.5	3	2.5	0.35	1.73	0.95	13.9

Single-row tapered roller bearings
metric series

d (105) ~ 120 mm

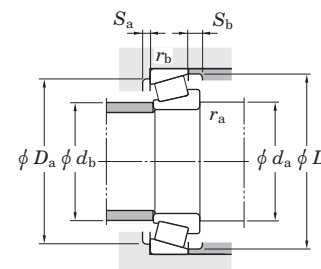
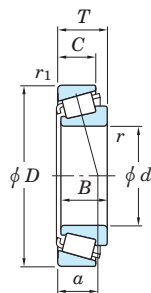

Boundary dimensions (mm)							Basic load ratings (kN)		Limiting speeds (min ⁻¹)		Bearing No.	Dimension series to ISO355 (Refer.)	Load center (mm) <i>a</i>	Mounting dimensions (mm)								Constant <i>e</i>	Axial load factors		(Refer.) Mass (kg)	
<i>d</i>	<i>D</i>	<i>T</i>	<i>B</i>	<i>C</i>	<i>r</i> min.	<i>r</i> ₁ min.	<i>C</i> _r	<i>C</i> _{0r}	Grease lub.	Oil lub.				<i>d</i> _a min.	<i>d</i> _b max.	<i>D</i> _a max.	<i>D</i> _b min.	<i>S</i> _a min.	<i>S</i> _b min.	<i>r</i> _a max.	<i>r</i> _b max.		<i>Y</i> ₁	<i>Y</i> ₀		
105	225	81.5	77	63	4	3	635	866	1 800	2 300	32321JR	2GD	56.1	123	128	211	185	209	8	18.5	3	2.5	0.35	1.74	0.96	14.9
110	150	25	25	20	1.5	1.5	129	231	2 300	3 000	32922JR	2CC	26.3	119	118	141	138	145	5	5	1.5	1.5	0.36	1.69	0.93	1.28
	160	27	25.5	19.5	3	3	146	225	2 200	2 900	T4CB110	4CB	31.8	124	120	146	145	154	5	7.5	2.5	2.5	0.44	1.36	0.75	1.63
	170	38	38	29	2.5	2	248	395	2 100	2 800	32022JR	4DC	36.1	122	122	160	152	163	7	9	2	2	0.43	1.39	0.77	3.12
	170	47	47	37	2.5	2	287	502	2 100	2 800	33022JR	2DE	33.4	122	123	160	152	161	7	10	2	2	0.29	2.09	1.15	3.81
	180	56	56	43	2.5	2	369	634	2 000	2 700	33122JR	3EE	44.5	122	121	170	155	174	9	13	2	2	0.42	1.43	0.79	5.52
	200	41	38	32	3	2.5	324	434	1 900	2 500	30222JR	3FB	40.8	124	129	188	174	188	6	9	2.5	2	0.42	1.43	0.79	5.33
	200	56	53	46	3	2.5	438	640	1 900	2 500	32222JR	3FC	46.7	124	126	188	170	190	6	10	2.5	2	0.42	1.43	0.79	7.45
	240	54.5	50	36	4	3	365	429	1 400	1 900	30322D	—	71.5	128	135	226	205	222	6	18	3	2.5	0.81	0.74	0.41	10.2
	240	54.5	50	42	4	3	407	475	1 600	2 100	30322	—	44.8	128	141	226	206	222	8	12.5	3	2.5	0.35	1.73	0.95	10.4
	240	54.5	50	42	4	3	481	590	1 600	2 100	30322JR	2GB	46.3	128	141	226	206	222	8	12.5	3	2.5	0.35	1.74	0.96	11.4
	240	63	57	38	4	3	452	563	1 400	1 900	31322JR	7GB	76.2	128	135	226	205	224	6	21	3	2.5	0.83	0.73	0.40	12.2
	240	84.5	80	65	4	3	607	797	1 600	2 200	32322	—	57.3	128	137	226	198	222	9	19.5	3	2.5	0.35	1.73	0.95	16.6
240	84.5	80	65	4	3	691	943	1 600	2 200	32322JR	2GD	59.3	128	137	226	198	222	9	19.5	3	2.5	0.35	1.74	0.96	17.8	
120	165	29	29	23	1.5	1.5	172	298	2 100	2 700	32924JR	2CC	29.4	129	128	156	152	160	6	6	1.5	1.5	0.35	1.72	0.95	1.77
	170	27	25	19.5	3	3	164	262	2 000	2 700	T4CB120	4CB	34.6	134	130	156	155	164	4	7.5	2.5	2.5	0.47	1.27	0.70	1.76
	180	38	38	29	2.5	2	258	427	2 000	2 600	32024JR	4DC	38.8	132	131	170	161	173	7	9	2	2	0.46	1.31	0.72	3.34
	180	48	48	38	2.5	2	299	540	2 000	2 600	33024JR	2DE	36.2	132	132	170	160	171	6	10	2	2	0.31	1.97	1.08	4.16
	200	62	62	48	2.5	2	462	785	1 800	2 400	33124JR	3FE	47.8	132	133	190	172	192	9	14	2	2	0.40	1.51	0.83	7.73
	215	43.5	40	34	3	2.5	347	473	1 700	2 300	30224JR	4FB	44.2	134	140	203	187	203	6	9.5	2.5	2	0.44	1.38	0.76	6.36
	215	61.5	58	50	3	2.5	470	691	1 700	2 300	32224JR	4FD	51.6	134	136	203	181	204	7	11.5	2.5	2	0.44	1.38	0.76	9.04
	260	59.5	55	38	4	3	430	512	1 200	1 700	30324D	—	77.8	138	145	246	219	239	6	21	3	2.5	0.81	0.74	0.41	13.0
	260	59.5	55	46	4	3	505	611	1 500	2 000	30324	—	48.9	138	152	246	221	239	10	13.5	3	2.5	0.35	1.73	0.95	13.7
	260	59.5	55	46	4	3	569	714	1 500	2 000	30324JR	2GB	50.2	138	152	246	221	239	10	13.5	3	2.5	0.35	1.74	0.96	14.5
	260	68	62	42	4	3	526	665	1 300	1 800	31324JR	7GB	81.9	138	145	246	221	244	6	21	3	2.5	0.83	0.73	0.40	15.4
	260	90.5	86	69	4	3	800	1 110	1 500	2 000	32324JR	2GD	62.7	138	148	246	213	239	9	21.5	3	2.5	0.35	1.74	0.96	22.2
260	90.5	86	69	4	3	797	1 110	1 500	2 000	32324R	—	61.1	138	148	246	213	239	9	21.5	3	2.5	0.35	1.73	0.95	21.8	

Single-row tapered roller bearings
metric series

d 130 ~ (150) mm

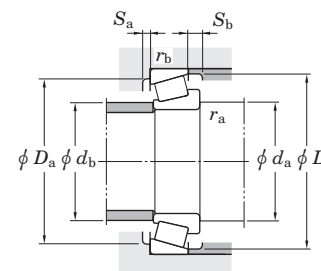
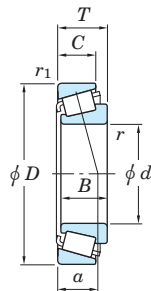

Boundary dimensions (mm)							Basic load ratings (kN)		Limiting speeds (min ⁻¹)		Bearing No.	Dimension series to ISO355 (Refer.)	Load center (mm) a	Mounting dimensions (mm)								Constant e	Axial load factors		(Refer.) Mass (kg)	
d	D	T	B	C	r min.	r1 min.	Cr	C0r	Grease lub.	Oil lub.				da min.	db max.	Da max.	Db min.	Sa min.	Sb min.	ra max.	rb max.		Y1	Y0		
130	180	32	32	25	2	1.5	200	368	1 900	2 500	32926JR	2CC	31.4	140	141	171	165	174	6	7	2	1.5	0.34	1.77	0.97	2.42
	185	29	27	21	3	3	183	282	1 800	2 500	T4CB130	4CB	37.8	144	141	171	170	179	5	8	2.5	2.5	0.47	1.27	0.70	2.22
	200	45	45	34	2.5	2	340	563	1 800	2 300	32026JR	4EC	42.9	142	144	190	178	192	8	11	2	2	0.43	1.38	0.76	5.04
	200	55	55	43	2.5	2	390	705	1 700	2 300	33026JR	2EE	42.5	142	143	190	178	192	8	12	2	2	0.34	1.76	0.97	6.19
	230	43.75	40	34	4	3	377	511	1 600	2 100	30226JR	4FB	46.2	148	152	216	203	218	7	9.5	3	2.5	0.44	1.38	0.76	7.24
	230	67.75	64	54	4	3	554	830	1 600	2 200	32226JR	4FD	56.0	148	146	216	193	219	7	13.5	3	2.5	0.44	1.38	0.76	11.5
	280	63.75	58	41	5	4	485	582	1 200	1 600	30326D	—	84.0	152	155	262	240	261	7	22	4	3	0.81	0.74	0.41	16.3
	280	63.75	58	49	5	4	657	834	1 400	1 800	30326JR	2GB	54.0	152	164	262	239	255	8	14.5	4	3	0.35	1.74	0.96	18.1
	280	72	66	44	5	4	589	748	1 200	1 600	31326JR	7GB	87.3	152	155	262	236	261	7	23	4	3	0.83	0.73	0.40	18.9
	280	98.75	93	78	5	4	852	1 160	1 400	1 800	32326	—	69.1	152	163	262	226	259	10	15	4	3	0.35	1.73	0.95	26.5
140	190	32	32	25	2	1.5	206	390	1 800	2 300	32928JR	2CC	33.6	150	150	181	174	184	6	7	2	1.5	0.36	1.67	0.92	2.57
	195	29	27	21	3	3	185	293	1 700	2 300	T4CB140	4CB	40.9	154	151	181	180	189	5	8	2.5	2.5	0.50	1.19	0.66	2.36
	210	45	45	34	2.5	2	346	585	1 700	2 200	32028JR	4DC	45.6	152	153	200	187	202	8	11	2	2	0.46	1.31	0.72	5.28
	210	56	56	44	2.5	2	406	758	1 600	2 200	33028JR	2DE	45.6	152	152	200	186	202	7	12	2	2	0.36	1.67	0.92	6.61
	250	45.75	42	36	4	3	420	570	1 500	1 900	30228JR	4FB	49.4	158	163	236	219	237	9	9.5	3	2.5	0.44	1.38	0.76	8.97
	250	71.75	68	58	4	3	636	961	1 500	2 000	32228JR	4FD	60.0	158	158	236	210	238	9	13.5	3	2.5	0.44	1.38	0.76	14.7
	300	67.75	62	44	5	4	525	627	1 100	1 500	30328D	—	90.2	162	169	282	254	280	7	23	4	3	0.81	0.74	0.41	20.0
	300	67.75	62	53	5	4	749	962	1 300	1 700	30328JR	2GB	56.9	162	179	282	254	273	10	14.5	4	3	0.35	1.74	0.96	22.6
	300	77	70	47	5	4	674	865	1 100	1 500	31328JR	7GB	93.8	162	167	282	254	280	8	26	4	3	0.83	0.73	0.40	23.3
	300	107.75	102	85	5	4	1 110	1 570	1 300	1 700	32328R	—	74.2	162	175	282	246	280	10	17	4	3	0.35	1.74	0.96	35.1
150	210	38	38	30	2.5	2	286	536	1 600	2 100	32930JR	2DC	36.1	162	163	200	194	202	7	8	2	2	0.33	1.83	1.01	3.96
	225	48	48	36	3	2.5	391	668	1 500	2 000	32030JR	4EC	48.8	164	164	213	200	216	8	12	2.5	2	0.46	1.31	0.72	6.41
	225	59	59	46	3	2.5	459	869	1 500	2 000	33030JR	2EE	47.8	164	164	213	200	217	8	13	2.5	2	0.36	1.65	0.90	8.09
	270	49	45	38	4	3	483	664	1 300	1 800	30230JR	4GB	52.4	168	175	256	234	255	9	11	3	2.5	0.44	1.38	0.76	11.6
	270	77	73	60	4	3	704	1 070	1 300	1 800	32230JR	4GD	65.2	168	170	256	226	254	8	17	3	2.5	0.44	1.38	0.76	18.2
	320	72	65	46	5	4	616	750	970	1 400	30330D	—	96.0	172	183	302	270	301	9	26	4	3	0.81	0.74	0.41	23.9
	320	72	65	55	5	4	837	1 080	1 200	1 500	30330JR	2GB	60.8	172	193	302	272	292	12	17	4	3	0.35	1.74	0.96	26.6

Single-row tapered roller bearings
metric series

d (150) ~ (190) mm

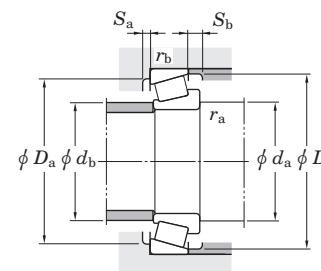
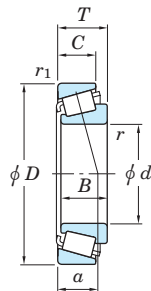

Boundary dimensions (mm)							Basic load ratings (kN)		Limiting speeds (min ⁻¹)		Bearing No.	Dimension series to ISO355 (Refer.)	Load center (mm) a	Mounting dimensions (mm)								Constant e	Axial load factors		(Refer.) Mass (kg)				
d	D	T	B	C	r min.	r1 min.	Cr	C0r	Grease lub.	Oil lub.				da min.	db max.	Da max.	Db min.	Sa min.	Sb min.	ra max.	rb max.		Y1	Y0					
150	320	82	75	50	5	4	763	989	980	1 400	31330JR 32330R	7GB —	100.1 78.4	172	179	302	272	301	9	27	4	3	0.83	0.73	0.40	28.0			
	320	114	108	90	5	4	1 240	1 790	1 200	1 600				—	—	172	187	302	263	298	10	17	4	3	0.35	1.74	0.96	42.0	
160	220	32	30	23	3	3	225	379	1 500	2 000	T4DB160 32932JR 32032JR 30232JR 32232JR 30332D 30332JR 32332	4DB 2DC 4EC 4GB 4GD — 2GB —	44.7 38.4 52.1 56.3 70.3 — 63.3 83.0	174	172	206	204	213	5	9	2.5	2.5	0.49	1.23	0.68	3.23			
	220	38	38	30	2.5	2	295	568	1 500	2 000				—	—	38.4	172	173	210	204	212	7	8	2	2	0.35	1.73	0.95	4.19
	240	51	51	38	3	2.5	440	758	1 400	1 900				—	—	52.1	174	175	228	213	231	8	13	2.5	2	0.46	1.31	0.72	7.75
	290	52	48	40	4	3	542	750	1 200	1 600				—	—	56.3	178	189	276	252	269	8	12	3	2.5	0.44	1.38	0.76	14.1
	290	84	80	67	4	3	795	1 210	1 200	1 700				—	—	70.3	178	182	276	242	274	10	17	3	2.5	0.44	1.38	0.76	23.2
	340	75	68	48	5	4	742	933	900	1 300				—	—	101.8	182	195	322	290	320	9	27	4	3	0.81	0.74	0.41	29.1
	340	75	68	58	5	4	938	1 220	1 100	1 400				—	—	63.3	182	205	322	289	310	12	17	4	3	0.35	1.74	0.96	31.8
340	121	114	95	5	4	1 220	1 720	1 100	1 400	—	—	83.0	182	200	322	277	316	10	18	4	3	0.35	1.73	0.95	47.9				
170	230	38	38	30	2.5	2	296	606	1 400	1 900	32934JR 32034JR 30234JR 32234JR 30334D 30334JR 32334	3DC 4EC 4GB 4GD — 2GB —	42.0 55.8 61.2 76.2 — 67.9 86.1	182	183	220	213	222	7	8	2	2	0.38	1.57	0.86	4.49			
	260	57	57	43	3	2.5	526	905	1 300	1 700				—	—	55.8	184	187	248	230	249	10	14	2.5	2	0.44	1.35	0.74	10.5
	310	57	52	43	5	4	620	867	1 100	1 500				—	—	61.2	192	202	292	269	288	8	14	4	3	0.44	1.38	0.76	17.8
	310	91	86	71	5	4	898	1 380	1 100	1 500				—	—	76.2	192	195	292	259	294	10	20	4	3	0.44	1.38	0.76	28.9
	360	80	72	50	5	4	762	1 040	830	1 200				—	—	108.3	192	211	342	310	333	9	30	4	3	0.81	0.74	0.41	34.3
	360	80	72	62	5	4	1 040	1 370	1 000	1 300				—	—	67.9	192	218	342	306	329	13	18	4	3	0.35	1.74	0.96	37.5
	360	127	120	100	5	4	1 310	1 830	1 000	1 300				—	—	86.1	192	200	342	295	337	14	26	4	3	0.35	1.73	0.95	56.9
180	250	45	45	34	2.5	2	357	735	1 300	1 700	32936JR 32036JR 30236JR 32236JR 30336D 30336 32336	4DC 3FD 4GB 4GD — — —	53.5 59.5 63.6 77.8 — — 91.8	192	193	240	225	241	8	11	2	2	0.48	1.25	0.69	6.64			
	280	64	64	48	3	2.5	644	1 100	1 200	1 600				—	—	59.5	194	199	268	247	268	10	16	2.5	2	0.42	1.42	0.78	14.1
	320	57	52	43	5	4	615	870	1 100	1 400				—	—	63.6	202	211	302	278	297	9	14	4	3	0.45	1.33	0.73	18.3
	320	91	86	71	5	4	957	1 520	1 100	1 500				—	—	77.8	202	204	302	267	303	10	20	4	3	0.45	1.33	0.73	29.9
	380	83	75	52	5	4	833	1 150	780	1 100				—	—	112.8	202	225	362	330	351	10	31	4	3	0.81	0.74	0.41	40.1
	380	83	75	64	5	4	901	1 110	940	1 300				—	—	71.0	202	227	362	318	346	13	19	4	3	0.35	1.73	0.95	39.7
	380	134	126	106	5	4	1 410	1 980	960	1 300				—	—	91.8	202	215	362	310	355	14	27	4	3	0.35	1.73	0.95	67.0
190	260	45	45	34	2.5	2	366	789	1 200	1 600	32938JR 32038JR	4DC 4FD	55.0 62.9	202	204	250	235	252	8	11	2	2	0.48	1.26	0.69	6.89			
	290	64	64	48	3	2.5	654	1 170	1 100	1 500				—	—	62.9	204	209	278	257	279	10	16	2.5	2	0.44	1.36	0.75	14.7

Single-row tapered roller bearings
metric series

d (190) ~ 260 mm

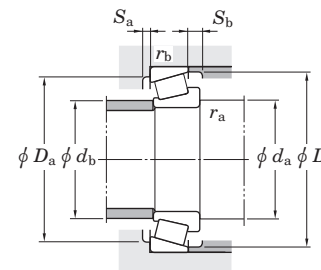
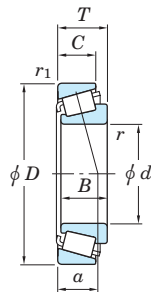

Boundary dimensions (mm)							Basic load ratings (kN)		Limiting speeds (min ⁻¹)		Bearing No.	Dimension series to ISO355 (Refer.)	Load center (mm) a	Mounting dimensions (mm)								Constant e	Axial load factors		(Refer.) Mass (kg)													
d	D	T	B	C	r min.	r1 min.	Cr	C0r	Grease lub.	Oil lub.				da min.	db max.	Da max.	Db min.	Sa min.	Sb min.	ra max.	rb max.		Y1	Y0														
190	340	60	55	46	5	4	729	1 030	1 000	1 300	30238JR	4GB	66.4	212	225	322	298	318	12	13	4	3	0.44	1.38	0.76	21.9												
	340	97	92	75	5	4	1 090	1 740	1 000	1 300			32238JR	4GD	81.9	212	216	322	286	323	12	22	4	3	0.44	1.38	0.76	36.6										
	400	86	78	52	6	5	950	1 210	740	1 000					30338D	—	119.2	218	232	378	350	372	11	34	5	4	0.81	0.74	0.41	44.8								
	400	86	78	65	6	5	1 010	1 250	880	1 200							30338	—	73.2	218	241	378	342	370	10	20	5	4	0.35	1.73	0.95	46.2						
	400	140	132	109	6	5	1 550	2 190	890	1 200									32338	—	96.5	218	225	378	330	375	14	30	5	4	0.35	1.73	0.95	76.6				
200	280	51	51	39	3	2.5	486	958	1 100	1 500	32940JR	3EC	53.6	214	216	268	257	271	9	12	2.5	2	0.39	1.52	0.84	9.44												
	310	70	70	53	3	2.5	755	1 340	1 100	1 400			32040JR	4FD	66.9	214	221	298	273	297	11	17	2.5	2	0.43	1.39	0.77	19.1										
	360	64	58	48	5	4	792	1 120	940	1 200					30240JR	4GB	70.3	222	238	342	315	336	12	15	4	3	0.44	1.38	0.76	26.4								
	360	104	98	82	5	4	1 240	1 880	960	1 300							32240JR	3GD	84.6	222	225	342	302	340	11	22	4	3	0.41	1.48	0.81	44.2						
	420	89	80	56	6	5	904	1 230	690	970									30340D	—	122.6	228	248	398	365	385	11	33	5	4	0.81	0.74	0.41	50.6				
	420	89	80	67	6	5	1 120	1 450	820	1 100											30340	—	79.8	228	255	398	354	385	11	21	5	4	0.35	1.73	0.95	53.5		
	420	146	138	115	6	5	1 790	2 580	830	1 100													32340	—	102.9	228	240	398	345	395	16	30	5	4	0.35	1.73	0.95	91.0
	220	300	51	51	39	3	2.5	498	1 010	1 000															1 400	32944JR	3EC	58.6	234	234	288	275	290	9	12	2.5	2	0.43
340		76	76	57	4	3	894	1 620	940	1 300	32044JR	4FD	72.8	238	243	326	300	326	12	19	3	2.5	0.43	1.39	0.77			25.2										
400		72	65	54	5	4	1 010	1 440	830	1 100			30244JR	—	76.5	242	263	382	344	371	14	17	4	3	0.44			1.43	0.79	35.9								
400		114	108	90	5	4	1 190	1 930	830	1 100					32244	—	95.9	242	260	382	333	377	16	14	4			3	0.43	1.39	0.77	56.8						
460		97	88	73	6	5	1 260	1 680	730	980							30344	—	84.6	248	282	438	386	420	12			23	5	4	0.35	1.73	0.95	69.0				
240	320	51	51	39	3	2.5	515	1 090	940	1 300	32948JR	4EC	64.5	254	254	308	294	311	9	12	2.5	2	0.46	1.31	0.72	10.9												
	360	76	76	57	4	3	924	1 720	870	1 200			32048JR	4FD	78.5	258	261	346	318	346	12	19	3	2.5	0.46	1.31	0.72	26.8										
	440	79	72	60	5	4	1 230	1 790	730	980					30248R	—	82.7	262	287	422	377	409	14	18	4	3	0.42	1.43	0.79	49.5								
	440	127	120	100	5	4	1 530	2 480	740	980							32248	—	106.1	262	282	422	365	415	16	14	4	3	0.43	1.39	0.77	76.4						
260	360	63.5	63.5	48	3	2.5	741	1 550	830	1 100	32952JR	3EC	69.6	274	279	348	328	347	11	15.5	2.5	2	0.41	1.48	0.81	18.9												
	400	87	87	65	5	4	1 170	2 170	770	1 000			32052JR	4FC	85.0	282	287	382	352	383	14	22	4	3	0.43	1.38	0.76	39.5										
	480	89	80	67	6	5	1 210	1 860	650	870					30252	—	93.6	288	310	458	415	450	14	21	5	4	0.42	1.44	0.79	64.9								
	480	137	130	106	6	5	1 760	2 870	660	880							32252	—	115.2	288	300	458	400	455	16	30	5	4	0.43	1.39	0.77	102						

Single-row tapered roller bearings
metric series

d 280 ~ 360 mm

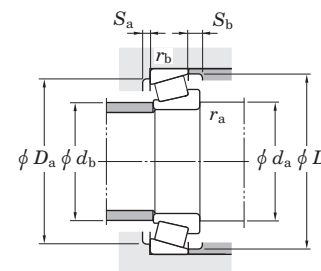
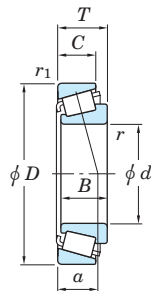

Boundary dimensions (mm)							Basic load ratings (kN)		Limiting speeds (min ⁻¹)		Bearing No.	Dimension series to ISO355 (Refer.)	Load center (mm) a	Mounting dimensions (mm)								Constant e	Axial load factors		(Refer.) Mass (kg)	
d	D	T	B	C	r min.	r1 min.	Cr	C0r	Grease lub.	Oil lub.				da min.	db max.	Da max.	Db min.	Sa min.	Sb min.	ra max.	rb max.		Y1	Y0		
280	380	63.5	63.5	48	3	2.5	760	1 630	770	1 000	32956JR	4EC	75.1	294	298	368	347	368	11	15.5	2.5	2	0.43	1.39	0.76	20.1
	420	87	87	65	5	4	1 200	2 280	720	960	32056JR	4FC	91.1	302	305	402	370	402	14	22	4	3	0.46	1.31	0.72	41.7
	500	89	80	67	6	5	1 260	1 920	610	810	30256	—	96.2	308	325	478	440	475	14	21	5	4	0.42	1.44	0.79	67.6
	500	137	130	106	6	5	1 860	3 150	610	810	32256	—	117.2	308	325	478	420	474	16	30	5	4	0.43	1.39	0.77	108
300	420	76	76	57	4	3	1 050	2 210	680	910	32960JR	3FD	79.9	318	324	406	383	405	12	19	3	2.5	0.39	1.52	0.84	32.4
	460	100	100	74	5	4	1 430	2 660	640	850	32060JR	4GD	97.9	322	329	442	404	439	15	26	4	3	0.43	1.38	0.76	57.5
	540	96	85	71	6	5	1 510	2 360	550	730	30260	—	103.9	328	350	518	475	505	14	24	5	4	0.42	1.44	0.79	84.7
320	440	76	76	57	4	3	1 060	2 270	640	850	32964JR	3FD	85.0	338	342	426	401	426	12	19	3	2.5	0.42	1.44	0.79	34.0
	480	100	100	74	5	4	1 510	2 810	600	800	32064JR	4GD	103.0	342	344	462	418	461	16	26	4	3	0.46	1.31	0.72	58.7
	580	104	92	75	6	5	1 740	2 770	490	660	30264	—	111.9	348	370	558	505	540	14	28	5	4	0.42	1.44	0.79	108
340	460	76	76	57	4	3	1 070	2 340	590	790	32968JR	4FD	90.5	358	361	446	420	446	12	19	3	2.5	0.44	1.37	0.75	35.6
360	480	76	76	57	4	3	1 080	2 400	560	740	32972JR	4FD	96.2	378	379	466	438	466	12	19	3	2.5	0.46	1.31	0.72	37.1

Single-row tapered roller bearings
inch series

d 9.525 ~ (22.225) mm

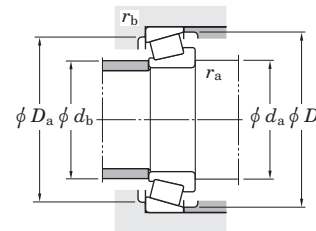
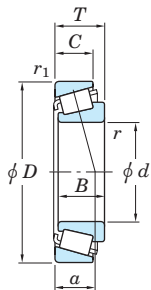

Boundary dimensions (mm)							Basic load ratings (kN)		Limiting speeds (min ⁻¹)		Inner ring	Outer ring	Load center (mm) a	Mounting dimensions (mm)						Constant e	Axial load factors		(Refer.) Mass (kg)	
d	D	T	B	C	$r_{min.}$	$r_{1 min.}$	C_r	C_{0r}	Grease lub.	Oil lub.				d_a	d_b	D_a	D_b	$r_{a max.}$	$r_{b max.}$		Y_1	Y_0	Inner ring	Outer ring
9.525	31.991	10.008	10.785	7.938	1.2	1.2	10.7	9.30	14 000	19 000	A2037	A2126	7.1	15.0	13.5	26.0	29.0	1.2	1.2	0.40	1.48	0.82	0.029	0.017
11.986	31.991	10.008	10.785	7.938	0.8	1.2	10.7	9.30	14 000	19 000	A2047	A2126	7.1	16.5	15.5	26.0	29.0	0.8	1.2	0.40	1.48	0.82	0.023	0.017
12.700	34.988	10.998	10.988	8.730	1.2	1.2	12.6	11.9	12 000	17 000	A4050	A4138	8.3	18.5	17.0	29.0	32.0	1.2	1.2	0.45	1.33	0.73	0.033	0.022
14.989	34.988	10.998	10.988	8.730	0.8	1.2	12.6	11.9	12 000	17 000	A4059	A4138	8.3	19.5	19.0	29.0	32.0	0.8	1.2	0.45	1.33	0.73	0.029	0.022
15.875	34.988	10.998	10.998	8.712	1.2	1.2	14.5	14.3	12 000	16 000	L21549	L21511	7.6	21.5	19.5	29.0	32.5	1.2	1.2	0.32	1.88	1.04	0.031	0.018
	41.275	14.288	14.681	11.112	1.2	2.0	21.8	20.5	11 000	14 000	03062	03162	9.3	21.5	20.0	34.0	37.5	1.2	2.0	0.31	1.93	1.06	0.060	0.035
	42.862	16.670	16.670	13.495	1.6	1.6	30.6	29.5	10 000	14 000	17580R	17520	10.9	23.0	21.0	36.5	39.0	1.6	1.6	0.33	1.81	1.00	0.078	0.048
	49.225	19.845	21.539	14.288	0.8	1.2	37.7	37.7	8 900	12 000	09062	09195	10.6	22.0	21.5	42.0	44.5	0.8	1.2	0.27	2.26	1.24	0.139	0.065
	53.975	22.225	21.839	15.875	0.8	2.4	42.0	41.2	8 400	11 000	21063	21212	16.6	29.0	26.5	43.0	50.0	0.8	2.4	0.59	1.02	0.56	0.163	0.097
16.000	47.000	21.000	21.000	16.000	1.0	2.0	36.3	37.7	9 800	13 000	HM81649	HM81610	15.0	27.5	23.0	37.5	43.0	1.0	2.0	0.55	1.10	0.60	0.111	0.080
17.462	39.878	13.843	14.605	10.668	1.2	1.2	25.4	26.0	11 000	14 000	LM11749R	LM11710	8.6	23.0	21.5	34.0	37.0	1.2	1.2	0.29	2.10	1.15	0.058	0.028
19.050	45.237	15.494	16.637	12.065	1.2	1.2	29.4	30.1	9 400	13 000	LM11949	LM11910	10.0	25.0	23.5	39.5	41.5	1.2	1.2	0.30	2.00	1.10	0.081	0.044
	49.225	19.845	21.539	14.288	1.2	1.2	37.7	37.7	8 900	12 000	09078	09195	10.6	25.5	24.0	42.0	44.5	1.2	1.2	0.27	2.26	1.24	0.124	0.065
	49.225	21.209	19.050	17.462	1.2	1.6	37.7	37.7	8 900	12 000	09067	09196	13.8	25.5	24.0	41.5	44.5	1.2	1.6	0.27	2.26	1.24	0.114	0.084
20.000	50.005	13.495	14.260	9.525	1.6	1.0	26.7	28.8	7 900	11 000	07079	07196	10.8	27.5	26.0	44.5	47.0	1.6	1.0	0.40	1.49	0.82	0.104	0.034
20.638	49.225	19.845	19.845	15.875	1.6	1.6	36.4	37.7	8 600	12 000	12580	12520	12.7	28.5	26.0	42.5	45.5	1.6	1.6	0.32	1.86	1.02	0.116	0.067
21.430	50.005	17.526	18.288	13.970	1.2	1.2	39.1	40.7	8 500	11 000	M12649	M12610	11.1	27.5	25.5	44.0	46.0	1.2	1.2	0.28	2.16	1.19	0.119	0.058
21.987	45.974	15.494	16.637	12.065	1.2	1.2	30.1	34.6	8 900	12 000	LM12749	LM12711	10.0	27.5	26.0	40.0	42.5	1.2	1.2	0.31	1.96	1.08	0.078	0.043
22.225	50.005	17.526	18.288	13.970	1.2	1.2	39.1	40.7	8 500	11 000	M12648	M12610	11.1	28.5	26.5	44.0	46.0	1.2	1.2	0.28	2.16	1.19	0.115	0.058
	52.388	19.368	20.168	14.288	1.6	1.6	36.7	37.9	8 000	11 000	1380	1328	11.6	29.5	29.5	45.0	48.5	1.6	1.6	0.29	2.05	1.13	0.132	0.066
	53.975	19.368	20.168	14.288	1.6	1.6	36.7	37.9	8 000	11 000	1380	1329	11.6	29.5	29.5	46.0	49.0	1.6	1.6	0.29	2.05	1.13	0.137	0.082

[Remark] Inch series tapered roller bearings with bore diameter larger than 100 mm are shown in catalog "large size ball & roller bearings".

Single-row tapered roller bearings
inch series

d (22.225) ~ (26.988) mm

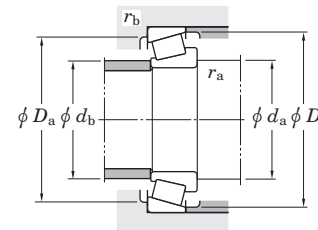
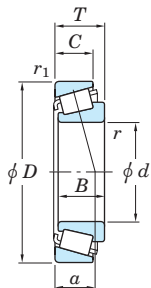

Boundary dimensions (mm)							Basic load ratings (kN)		Limiting speeds (min ⁻¹)		Bearing No.	Load center (mm) a	Mounting dimensions (mm)						Constant e	Axial load factors		(Refer.) Mass (kg)				
d	D	T	B	C	r _{min.}	r _{1 min.}	C _r	C _{0r}	Grease lub.	Oil lub.			Inner ring	Outer ring	d _a	d _b	D _a	D _b		r _{a max.}	r _{b max.}	Y ₁	Y ₀	Inner ring	Outer ring	
22.225	56.896	19.368	19.837	15.875	1.2	1.2	40.0	43.1	7 600	10 000	1755	1729	12.5	29.0	27.5	49.0	51.0	1.2	1.2	0.31	1.95	1.07	0.150	0.100		
	57.150	22.225	22.225	17.462	0.8	1.6	52.6	55.7	7 600	10 000			1280	1220	15.3	29.5	29.0	49.0	52.0	0.8	1.6	0.35	1.73	0.95	0.189	0.105
	66.421	23.812	25.433	19.050	1.6	1.2	67.0	75.2	6 500	8 700			2684	2631	13.9	31.5	29.0	58.0	60.0	1.6	1.2	0.25	2.36	1.30	0.295	0.163
22.606	47.000	15.500	15.500	12.000	1.6	1.0	28.0	32.8	8 700	12 000	LM72849	LM72810	12.3	30.0	28.0	40.5	44.0	1.6	1.0	0.47	1.27	0.70	0.076	0.047		
23.812	50.292	14.224	14.732	10.668	1.6	1.2	31.2	37.0	7 800	10 000	L44640R	L44610	10.8	30.5	28.5	44.5	47.0	1.6	1.2	0.37	1.60	0.88	0.099	0.034		
	56.896	19.368	19.837	15.875	0.8	1.2	40.0	43.1	7 600	10 000			1779	1729	12.5	29.5	28.5	49.0	51.0	0.8	1.2	0.31	1.95	1.07	0.141	0.100
24.981	50.005	13.495	14.260	9.525	1.6	1.0	26.7	28.8	7 900	11 000	07098	07196	10.8	31.0	29.0	44.5	47.0	1.6	1.0	0.40	1.49	0.82	0.084	0.034		
	62.000	16.002	16.566	14.288	1.6	1.6	38.0	40.6	6 700	8 900			17098	17244	12.7	33.0	30.5	54.0	57.0	1.6	1.6	0.38	1.57	0.86	0.162	0.090
25.000	50.005	13.495	14.260	9.525	1.6	1.0	26.7	28.8	7 900	11 000	07097	07196	10.8	31.0	29.0	44.5	47.0	1.6	1.0	0.40	1.49	0.82	0.085	0.035		
25.400	50.005	13.495	14.260	9.525	1.0	1.0	26.7	28.8	7 900	11 000	07100	07196	10.8	30.5	29.5	44.5	47.0	1.0	1.0	0.40	1.49	0.82	0.084	0.035		
	50.005	13.495	14.260	9.525	1.6	1.0	26.7	28.8	7 900	11 000	07100S	07196	10.8	31.5	29.5	44.5	47.0	1.6	1.0	0.40	1.49	0.82	0.082	0.035		
	50.292	14.224	14.732	10.668	1.2	1.2	31.2	37.0	7 800	10 000	L44643R	L44610	10.8	31.5	29.5	44.5	47.0	1.2	1.2	0.37	1.60	0.88	0.092	0.039		
	51.994	15.011	14.260	12.700	1.0	1.2	26.7	28.8	7 900	11 000	07100	07204	12.3	30.5	29.5	45.0	48.0	1.0	1.2	0.40	1.49	0.82	0.075	0.065		
	58.738	19.050	19.355	15.080	1.2	1.2	48.8	57.1	7 000	9 300	1986R	1932	13.1	32.5	30.5	52.0	54.0	1.2	1.2	0.33	1.82	1.00	0.179	0.088		
	59.530	23.368	23.114	18.288	0.8	1.6	50.4	57.1	7 200	9 600	M84249	M84210	18.2	36.0	32.5	49.5	56.0	0.8	1.6	0.55	1.10	0.60	0.194	0.128		
	61.912	19.050	20.638	14.288	0.8	2.0	44.6	50.7	6 400	8 600	15101	15243	13.2	32.5	31.5	55.0	58.0	0.8	2.0	0.35	1.71	0.94	0.215	0.080		
	62.000	19.050	20.638	14.288	3.6	1.2	44.6	50.7	6 400	8 600	15100	15245	13.2	38.0	31.5	55.0	58.0	3.6	1.2	0.35	1.71	0.94	0.215	0.081		
	63.500	19.050	20.638	14.288	0.8	1.2	44.6	50.7	6 400	8 600	15101	15250R	13.2	32.5	31.5	55.0	59.0	0.8	1.2	0.35	1.71	0.94	0.215	0.097		
	64.292	21.432	21.432	16.670	1.6	1.6	55.2	70.7	6 400	8 500	M86643R	M86610	18.0	38.0	36.5	54.0	61.0	1.6	1.6	0.55	1.10	0.60	0.248	0.127		
	66.421	23.812	25.433	19.050	1.2	1.2	67.0	75.2	6 500	8 700	2687	2631	13.9	33.5	31.5	58.0	60.0	1.2	1.2	0.25	2.36	1.30	0.272	0.163		
	68.262	22.225	22.225	17.462	0.8	1.6	51.0	61.1	6 000	8 000	02473	02420	17.1	34.5	33.5	59.0	63.0	0.8	1.6	0.42	1.44	0.79	0.275	0.150		
	72.233	25.400	25.400	19.842	0.8	2.4	66.9	87.4	5 700	7 600	HM88630	HM88610	20.7	39.5	39.5	60.0	69.0	0.8	2.4	0.55	1.10	0.60	0.391	0.185		
	26.162	66.421	23.812	25.433	19.050	1.6	1.2	67.0	75.2	6 500	8 700	2682	2631	13.9	34.5	32.0	58.0	60.0	1.6	1.2	0.25	2.36	1.30	0.268	0.163	
26.988	50.292	14.224	14.732	10.668	3.6	1.2	31.2	37.0	7 800	10 000	L44649R	L44610	10.8	37.5	31.0	44.5	47.0	3.6	1.2	0.37	1.60	0.88	0.083	0.039		

[Remark] Inch series tapered roller bearings with bore diameter larger than 100 mm are shown in catalog "large size ball & roller bearings".

Single-row tapered roller bearings
inch series

d (26.988) ~ (30.162) mm

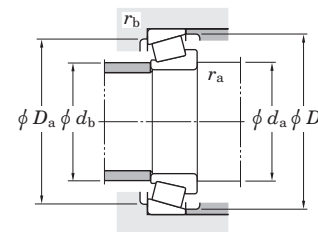
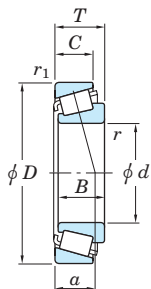

d	Boundary dimensions (mm)						Basic load ratings (kN)		Limiting speeds (min ⁻¹)		Bearing No.	Load center (mm) a	Mounting dimensions (mm)						Con-stant e	Axial load factors		(Refer.) Mass (kg)		
	D	T	B	C	$r_{min.}$	$r_{1 min.}$	C_r	C_{0r}	Grease lub.	Oil lub.			Inner ring	Outer ring	d_a	d_b	D_a	D_b		$r_{a max.}$	$r_{b max.}$	Y_1	Y_0	Inner ring
26.988	60.325	19.842	17.462	15.875	3.6	1.6	37.8	42.7	7 000	9 400	15580	15523	15.1	38.5	32.0	51.0	54.0	3.6	1.6	0.35	1.73	0.95	0.140	0.122
	62.000	19.050	20.638	14.288	0.8	1.2	44.6	50.7	6 400	8 600	15106	15245	13.2	33.5	33.0	55.0	58.0	0.8	1.2	0.35	1.71	0.94	0.206	0.081
	66.421	23.812	25.433	19.050	1.6	1.2	67.0	75.2	6 500	8 700	2688	2631	13.9	35.0	33.0	58.0	60.0	1.6	1.2	0.25	2.36	1.30	0.262	0.163
28.575	57.150	17.462	17.462	13.495	3.6	1.6	37.8	42.7	7 000	9 400	15590	15520	12.7	39.0	33.5	51.0	53.0	3.6	1.6	0.35	1.73	0.95	0.131	0.069
	57.150	19.845	19.355	15.875	3.6	1.6	48.8	57.1	7 000	9 300	1988R	1922	13.9	39.5	33.5	51.0	53.5	3.6	1.6	0.33	1.82	1.00	0.151	0.076
	62.000	19.050	20.638	14.288	3.6	1.2	44.6	50.7	6 400	8 600	15112	15245	13.2	40.0	34.0	55.0	58.0	3.6	1.2	0.35	1.71	0.94	0.193	0.081
	62.000	19.050	20.638	14.288	0.8	1.2	44.6	50.7	6 400	8 600	15113	15245	13.2	34.5	34.0	55.0	58.0	0.8	1.2	0.35	1.71	0.94	0.195	0.081
	64.292	21.432	21.432	16.670	1.6	1.6	55.2	70.7	6 400	8 500	M86647R	M86610	18.0	40.0	38.0	54.0	61.0	1.6	1.6	0.55	1.10	0.60	0.225	0.127
	66.421	23.812	25.433	19.050	1.2	1.2	67.0	75.2	6 500	8 700	2689	2631	13.9	36.0	34.0	58.0	60.0	1.2	1.2	0.25	2.36	1.30	0.249	0.165
	68.262	22.225	22.225	17.462	0.8	1.6	51.0	61.1	6 000	8 000	02474	02420	17.1	36.5	36.0	59.0	63.0	0.8	1.6	0.42	1.44	0.79	0.252	0.150
	72.000	19.000	18.923	15.875	1.6	1.6	47.5	49.6	5 900	7 800	26112	26283	15.3	37.0	35.0	62.0	65.0	1.6	1.6	0.36	1.67	0.92	0.217	0.163
	72.626	24.608	24.257	17.462	4.8	1.6	61.8	60.5	6 100	8 100	41125	41286	20.7	48.0	36.5	61.0	68.0	4.8	1.6	0.60	1.00	0.55	0.292	0.177
	72.626	24.608	24.257	17.462	1.6	1.6	61.8	60.5	6 100	8 100	41126	41286	20.7	41.5	36.5	61.0	68.0	1.6	1.6	0.60	1.00	0.55	0.295	0.177
	72.626	30.162	29.997	23.812	3.6	3.2	78.8	89.3	5 800	7 700	3192	3120	20.3	42.5	37.0	61.0	67.0	3.6	3.2	0.33	1.80	0.99	0.401	0.222
	72.626	30.162	29.997	23.812	1.2	3.2	78.8	89.3	5 800	7 700	3198	3120	20.3	39.0	37.0	61.0	67.0	1.2	3.2	0.33	1.80	0.99	0.410	0.222
	73.025	22.225	22.225	17.462	0.8	3.2	55.0	65.7	5 500	7 400	02872	02820	18.4	37.5	37.0	62.0	68.0	0.8	3.2	0.45	1.32	0.73	0.319	0.158
29.000	50.292	14.224	14.732	10.668	3.6	1.2	28.9	37.2	7 600	10 000	L45449	L45410	10.9	39.5	33.0	44.5	48.0	3.6	1.2	0.37	1.62	0.89	0.079	0.036
29.367	66.421	23.812	25.433	19.050	3.6	1.2	67.0	75.2	6 500	8 700	2690	2631	13.9	41.0	35.0	58.0	60.0	3.6	1.2	0.25	2.36	1.30	0.242	0.165
29.987	62.000	16.002	16.566	14.288	1.6	1.6	38.0	40.6	6 700	8 900	17118	17244	12.7	37.0	34.5	54.0	57.0	1.6	1.6	0.38	1.57	0.86	0.135	0.090
	62.000	19.050	20.638	14.288	1.2	1.2	44.6	50.7	6 400	8 600	15117	15245	13.2	36.5	35.0	55.0	58.0	1.2	1.2	0.35	1.71	0.94	0.184	0.081
30.000	69.012	19.845	19.583	15.875	3.6	1.2	46.1	55.0	5 900	7 800	14117A	14276	15.5	42.5	39.5	60.0	63.0	3.6	1.2	0.38	1.57	0.86	0.225	0.135
30.112	62.000	19.050	20.638	14.288	0.8	1.2	44.6	50.7	6 400	8 600	15116	15245	13.2	36.0	35.5	55.0	58.0	0.8	1.2	0.35	1.71	0.94	0.184	0.081
30.162	62.000	16.002	16.566	14.288	1.6	1.6	38.0	40.6	6 700	8 900	17119	17244	12.7	37.0	34.5	54.0	57.0	1.6	1.6	0.38	1.57	0.86	0.139	0.091
	64.292	21.432	21.432	16.670	1.6	1.6	55.2	70.7	6 400	8 500	M86649R	M86610	18.0	41.0	38.0	54.0	61.0	1.6	1.6	0.55	1.10	0.60	0.213	0.127

[Remark] Inch series tapered roller bearings with bore diameter larger than 100 mm are shown in catalog "large size ball & roller bearings".

Single-row tapered roller bearings
inch series

d (30.162) ~ (34.925) mm

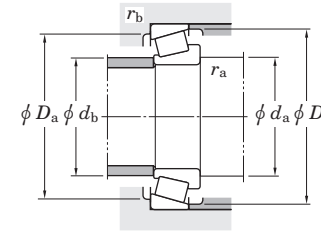
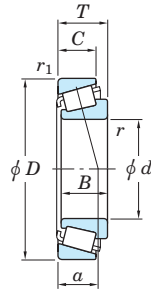

Boundary dimensions (mm)							Basic load ratings (kN)		Limiting speeds (min ⁻¹)		Inner ring	Outer ring	Load center (mm) a	Mounting dimensions (mm)						Con-stant e	Axial load factors Y ₁ Y ₀		(Refer.) Mass (kg)	
d	D	T	B	C	r ¹ min.	r ₁ min.	C _r	C _{0r}	Grease lub.	Oil lub.				d _a	d _b	D _a	D _b	r _a max.	r _b max.		Y ₁	Y ₀	Inner ring	Outer ring
30.162	68.262	22.225	22.225	17.462	2.4	1.6	56.1	71.1	6 000	7 900	M88043	M88010	19.2	43.5	39.5	58.0	65.0	2.4	1.6	0.55	1.10	0.60	0.258	0.144
30.213	62.000	19.050	20.638	14.288	3.6	1.2	44.6	50.7	6 400	8 600	15118	15245	13.2	41.5	35.5	55.0	58.0	3.6	1.2	0.35	1.71	0.94	0.181	0.081
	62.000	19.050	20.638	14.288	1.6	1.2	44.6	50.7	6 400	8 600	15119	15245	13.2	37.5	35.5	55.0	58.0	1.6	1.2	0.35	1.71	0.94	0.183	0.081
	62.000	19.050	20.638	14.288	0.8	1.2	44.6	50.7	6 400	8 600	15120	15245	13.2	36.0	35.5	55.0	58.0	0.8	1.2	0.35	1.71	0.94	0.183	0.081
30.226	69.012	19.845	19.583	15.875	0.8	3.2	46.1	55.0	5 900	7 800	14116	14274	15.5	37.0	36.5	59.0	63.0	0.8	3.2	0.38	1.57	0.86	0.226	0.131
31.750	58.738	14.684	15.080	10.716	1.0	1.0	29.5	33.3	6 600	8 900	08125	08231	13.5	37.5	36.0	52.0	55.0	1.0	1.0	0.48	1.26	0.69	0.109	0.056
	59.131	15.875	16.764	11.811	SP	1.2	35.8	43.1	6 600	8 800	LM67048	LM67010	13.0	42.5	36.0	52.0	56.0	3.5	1.2	0.41	1.46	0.80	0.120	0.062
	62.000	18.161	19.050	14.288	SP	1.2	44.6	50.7	6 400	8 600	15123	15245	13.2	42.5	36.5	55.0	58.0	3.5	1.2	0.35	1.71	0.94	0.157	0.081
	62.000	19.050	20.638	14.288	3.6	1.2	44.6	50.7	6 400	8 600	15125	15245	13.2	42.5	36.5	55.0	58.0	3.6	1.2	0.35	1.71	0.94	0.169	0.081
	62.000	19.050	20.638	14.288	0.8	1.2	44.6	50.7	6 400	8 600	15126	15245	13.2	37.0	36.5	55.0	58.0	0.8	1.2	0.35	1.71	0.94	0.171	0.081
	66.421	25.400	25.357	20.638	0.8	3.2	71.4	85.1	6 000	8 000	2580	2520	16.0	38.5	37.5	57.0	62.5	0.8	3.2	0.27	2.19	1.21	0.281	0.123
	68.262	22.225	22.225	17.462	3.6	1.6	51.0	61.1	6 000	8 000	02475	02420	17.1	44.5	38.5	59.0	63.0	3.6	1.6	0.42	1.44	0.79	0.224	0.150
	68.262	22.225	22.225	17.462	0.8	1.6	51.0	61.1	6 000	8 000	02476	02420	17.1	39.0	38.5	59.0	63.0	0.8	1.6	0.42	1.44	0.79	0.226	0.150
	68.262	22.225	22.225	17.462	1.6	1.6	56.1	71.1	6 000	7 900	M88046	M88010	19.2	43.0	40.5	58.0	65.0	1.6	1.6	0.55	1.10	0.60	0.245	0.144
	73.025	22.225	22.225	17.462	3.6	3.2	55.0	65.7	5 600	7 400	02875	02820	17.1	45.5	39.5	62.0	68.0	3.6	3.2	0.45	1.32	0.73	0.293	0.158
	73.025	22.225	22.225	17.462	0.8	3.2	55.0	65.7	5 500	7 400	02876	02820	17.1	40.0	39.5	62.0	68.0	0.8	3.2	0.45	1.32	0.73	0.293	0.158
	73.025	29.370	27.783	23.020	1.2	3.2	74.3	101	5 600	7 500	HM88542	HM88510	23.4	45.5	42.5	59.0	70.0	1.2	3.2	0.55	1.10	0.60	0.377	0.238
	73.812	29.370	27.783	23.020	1.2	3.2	74.3	101	5 600	7 500	HM88542	HM88512	23.4	45.5	42.5	59.0	70.0	1.2	3.2	0.55	1.10	0.60	0.377	0.254
33.338	68.262	22.225	22.225	17.462	0.8	1.6	56.1	71.1	6 000	7 900	M88048	M88010	19.2	42.5	41.0	58.0	65.0	0.8	1.6	0.55	1.10	0.60	0.231	0.144
	72.000	19.000	18.923	15.875	3.6	1.6	47.5	49.6	5 900	7 800	26131	26283	15.3	44.5	38.5	62.0	65.0	3.6	1.6	0.36	1.67	0.92	0.200	0.163
	73.025	29.370	27.783	23.020	0.8	3.2	74.3	101	5 600	7 500	HM88547	HM88510	23.4	45.5	42.6	59.0	70.0	0.8	3.2	0.55	1.10	0.60	0.360	0.238
	76.200	29.370	28.575	23.020	0.8	3.2	79.5	107	5 400	7 200	HM89443	HM89410	23.9	46.5	44.6	62.0	73.0	0.8	3.2	0.55	1.10	0.60	0.415	0.254
34.925	65.088	18.034	18.288	13.970	SP	1.2	48.0	58.5	6 000	8 000	LM48548	LM48510	14.3	46.0	40.0	58.0	61.0	3.5	1.2	0.38	1.59	0.88	0.164	0.086
	69.012	26.982	26.721	15.875	0.8	1.2	46.1	55.0	5 900	7 800	14136A	14276	22.6	40.0	38.0	60.0	63.0	0.8	1.2	0.38	1.57	0.86	0.254	0.133
	72.233	25.400	25.400	19.842	2.4	2.4	66.9	87.4	5 700	7 600	HM88649	HM88610	20.7	48.5	42.5	60.0	69.0	2.4	2.4	0.55	1.10	0.60	0.301	0.185

[Note] 1) SP indicates the specially chamfered from.

[Remark] Inch series tapered roller bearings with bore diameter larger than 100 mm are shown in catalog "large size ball & roller bearings".

Single-row tapered roller bearings
inch series

d (34.925) ~ (38.100) mm

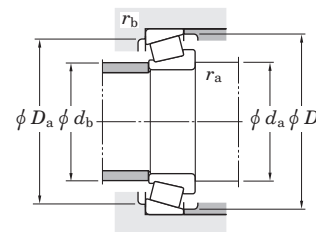
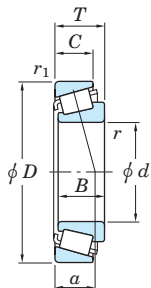

Boundary dimensions (mm)							Basic load ratings (kN)		Limiting speeds (min ⁻¹)		Bearing No. ²⁾	Load center (mm) a	Mounting dimensions (mm)					Constant e	Axial load factors		(Refer.) Mass (kg)			
d	D	T	B	C	$r_1^{1)}$ min.	$r_{1^{1)}$ min.	C_r	C_{0r}	Grease lub.	Oil lub.			Inner ring	Outer ring	d_a	d_b	D_a		D_b	r_a max.	r_b max.	Y_1	Y_0	Inner ring
34.925	72.238	20.638	20.638	15.875	3.6	1.2	49.7	61.3	5 600	7 400	16137	16284	16.6	46.5	40.5	63.0	67.0	3.6	1.2	0.40	1.49	0.82	0.236	0.144
	73.025	22.225	22.225	17.462	3.6	3.2	55.0	65.7	5 500	7 400	02877	02820	18.4	48.5	42.0	62.0	68.0	3.6	3.2	0.45	1.32	0.73	0.262	0.158
	73.025	22.225	22.225	17.462	0.8	3.2	55.0	65.7	5 500	7 400	02878	02820	18.4	42.5	42.0	62.0	68.0	0.8	3.2	0.45	1.32	0.73	0.265	0.158
	73.025	23.812	24.608	19.050	1.6	0.8	72.2	87.3	5 600	7 400	25877R	25821	15.8	43.0	40.5	65.0	68.0	1.6	0.8	0.29	2.07	1.14	0.310	0.165
	73.025	26.988	26.975	22.225	3.6	1.6	77.8	94.1	5 700	7 600	23690	23620	18.8	49.0	42.0	64.0	68.0	3.6	1.6	0.37	1.62	0.89	0.326	0.212
	76.200	20.638	20.940	15.507	1.6	1.2	57.3	65.9	5 300	7 000	28137	28300	16.5	43.5	41.0	68.0	71.0	1.6	1.2	0.40	1.49	0.82	0.315	0.137
	76.200	23.812	25.654	19.050	3.6	3.2	74.1	92.2	5 400	7 200	2796R	2720	15.9	47.5	41.0	66.0	70.0	3.6	3.2	0.30	1.98	1.09	0.344	0.185
	76.200	29.370	28.575	23.812	1.6	3.2	80.9	97.4	5 400	7 200	31594	31520	21.6	46.0	43.5	64.0	72.0	1.6	3.2	0.40	1.49	0.82	0.388	0.232
	79.375	29.370	29.771	23.812	3.6	3.2	87.4	105	5 200	6 900	3478	3420	20.8	50.0	43.5	67.0	74.0	3.6	3.2	0.37	1.64	0.90	0.462	0.256
	87.312	30.162	30.886	23.812	3.6	3.2	95.8	120	4 600	6 200	3581R	3525	20.5	48.0	45.5	75.0	81.0	3.6	3.2	0.31	1.96	1.08	0.622	0.300
	95.250	27.783	29.901	22.225	0.8	2.4	103	122	4 500	5 900	449	432	18.4	44.0	43.5	83.0	87.0	0.8	2.4	0.28	2.11	1.16	0.686	0.384
	34.980	59.131	15.875	16.764	11.938	SP	1.2	35.7	48.5	6 400	8 500	L68149	L68110	13.2	45.5	39.0	53.0	56.0	3.5	1.2	0.42	1.44	0.79	0.112
59.975		15.875	16.764	11.938	SP	1.2	35.7	48.5	6 400	8 500	L68149	L68111	13.2	45.5	39.0	53.0	56.0	3.5	1.2	0.42	1.44	0.79	0.112	0.063
35.000	79.375	23.812	25.400	19.050	0.8	0.8	81.1	105	5 000	6 700	26883R	26822	16.4	42.5	42.0	71.0	74.0	0.8	0.8	0.32	1.88	1.04	0.414	0.186
	80.000	21.000	22.403	17.826	0.8	1.2	68.0	74.8	4 900	6 600	339	332	15.1	42.5	41.5	73.0	75.0	0.8	1.2	0.27	2.20	1.21	0.385	0.144
35.717	72.233	25.400	25.400	19.842	3.6	2.4	66.9	87.4	5 700	7 600	HM88648	HM88610	20.7	52.0	42.5	60.0	69.0	3.6	2.4	0.55	1.10	0.60	0.291	0.185
36.487	73.025	23.812	24.608	19.050	1.6	0.8	72.2	87.3	5 600	7 400	25880R	25821	15.8	44.0	42.0	65.0	68.0	1.6	0.8	0.29	2.07	1.14	0.294	0.165
	73.025	23.812	25.654	19.050	3.6	0.8	74.1	92.2	5 400	7 200	2794R	2735X	15.9	49.0	42.5	66.0	69.0	3.6	0.8	0.30	1.98	1.09	0.344	0.134
36.512	76.200	29.370	28.575	23.020	3.6	0.8	79.5	107	5 400	7 200	HM89449	HM89411	23.9	54.0	44.5	65.0	73.0	3.6	0.8	0.55	1.10	0.60	0.386	0.258
	79.375	23.812	25.400	19.050	0.8	0.8	81.1	105	5 000	6 700	26877R	26822	16.4	44.0	43.0	71.0	74.0	0.8	0.8	0.32	1.88	1.04	0.404	0.186
	79.375	29.370	29.771	23.812	0.8	3.2	87.4	105	5 200	6 900	3479	3420	20.8	45.5	44.5	67.0	74.0	0.8	3.2	0.37	1.64	0.90	0.429	0.259
	85.725	30.162	30.162	23.812	0.8	3.2	108	136	4 800	6 400	3878	3820	22.9	48.0	47.0	73.0	81.0	0.8	3.2	0.40	1.49	0.82	0.605	0.285
38.000	63.000	17.000	17.000	13.500	SP	SP	43.5	58.2	6 000	8 000	JL69349	JL69310	14.6	49.0	41.0	60.0	56.5	3.5	1.2	0.42	1.44	0.79	0.128	0.070
38.100	63.500	12.700	11.908	9.525	1.6	0.8	25.5	33.1	5 800	7 700	13889	13830	11.9	45.0	42.5	59.0	60.0	1.6	0.8	0.35	1.73	0.95	0.104	0.045

[Notes] 1) SP indicates the specially chamfered from.
2) To the bearings with supplementary code "J" attached at the front of bearing number, tolerances shown in table 7-8 on page A66 are applied.

[Remark] Inch series tapered roller bearings with bore diameter larger than 100 mm are shown in catalog "large size ball & roller bearings".

Single-row tapered roller bearings inch series

d (38.100) ~ (40.000) mm

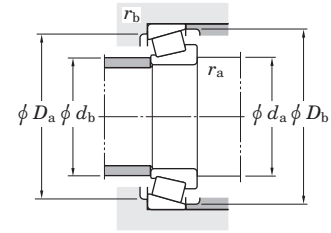
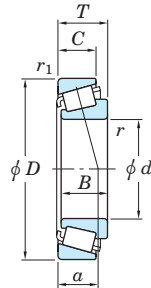

Boundary dimensions (mm)							Basic load ratings (kN)		Limiting speeds (min ⁻¹)		Bearings No.	Load center (mm)	Mounting dimensions (mm)						Con-stant	Axial load factors		(Refer.) Mass (kg)				
<i>d</i>	<i>D</i>	<i>T</i>	<i>B</i>	<i>C</i>	<i>r</i> ¹⁾ _{min.}	<i>r</i> _{1 min.}	<i>C_r</i>	<i>C</i> _{0r}	Grease lub.	Oil lub.			Inner ring	Outer ring	<i>d</i> _a	<i>d</i> _b	<i>D</i> _a	<i>D</i> _b		<i>r</i> _{a max.}	<i>r</i> _{b max.}	<i>e</i>	<i>Y</i> ₁	<i>Y</i> ₀	Inner ring	Outer ring
38.100	65.088	12.700	11.908	9.525	1.6	0.8	25.5	33.1	5 800	7 700	13889	13836	11.9	45.0	42.5	59.0	61.0	1.6	0.8	0.35	1.73	0.95	0.104	0.046		
	65.088	18.034	18.288	13.970	SP	1.2	42.9	56.5	5 800	7 800	LM29748	LM29710	13.8	49.0	42.5	59.0	62.0	3.5	1.2	0.33	1.80	0.99	0.154	0.079		
	65.088	19.812	18.288	15.748	2.4	1.2	42.9	56.5	5 800	7 800	LM29749	LM29711	15.6	46.0	42.5	58.0	62.0	2.4	1.2	0.33	1.80	0.99	0.159	0.092		
	69.012	19.050	19.050	15.083	2.0	2.4	49.2	62.0	5 600	7 500	13687	13621	16.1	46.5	43.0	61.0	65.0	2.0	2.4	0.40	1.49	0.82	0.191	0.102		
	71.438	15.875	16.520	11.908	1.6	1.0	46.1	53.8	5 700	7 600	19150R	19281	14.5	45.0	43.0	63.0	66.0	1.6	1.0	0.44	1.35	0.74	0.167	0.105		
	71.996	17.018	16.520	14.288	1.6	1.6	46.1	53.8	5 700	7 600	19150R	19283	15.7	45.0	43.0	63.0	66.0	1.6	1.6	0.44	1.35	0.74	0.167	0.132		
	71.996	19.000	20.638	14.237	3.6	1.6	49.7	61.3	5 600	7 400	16150	16282	15.0	49.5	43.0	63.0	67.0	3.6	1.6	0.40	1.49	0.82	0.207	0.121		
	72.238	20.638	20.638	15.875	3.6	1.2	49.7	61.3	5 600	7 400	16150	16284	16.6	49.5	43.0	63.0	67.0	3.6	1.2	0.40	1.49	0.82	0.207	0.144		
	72.238	23.812	20.638	19.050	3.6	2.4	49.7	61.3	5 600	7 400	16150	16283	19.8	49.5	43.0	61.0	67.0	3.6	2.4	0.40	1.49	0.82	0.207	0.183		
	73.025	23.812	25.654	19.050	3.6	0.8	74.1	92.2	5 400	7 200	2788R	2735X	15.9	50.0	43.5	66.0	69.0	3.6	0.8	0.30	1.98	1.09	0.308	0.134		
	76.200	23.812	25.654	19.050	3.6	0.8	74.1	92.2	5 400	7 200	2788R	2729	15.9	50.0	43.5	68.0	70.0	3.6	0.8	0.30	1.98	1.09	0.308	0.189		
	79.375	29.370	29.771	23.812	3.6	3.2	87.4	105	5 200	6 900	3490	3420	20.8	52.0	45.9	67.0	74.0	3.6	3.2	0.37	1.64	0.90	0.419	0.256		
	80.035	21.432	20.940	15.875	1.6	1.6	57.3	65.9	5 300	7 000	28150	28317	16.9	45.5	43.5	69.0	73.0	1.6	1.6	0.40	1.49	0.82	0.285	0.201		
	80.035	24.608	23.698	18.512	0.8	1.6	73.2	91.6	5 200	6 900	27880	27820	22.2	48.0	47.0	68.0	75.0	0.8	1.6	0.56	1.07	0.59	0.378	0.208		
	80.035	24.608	23.698	18.512	3.6	1.6	73.2	91.6	5 200	6 900	27881	27820	22.2	53.0	47.0	68.0	75.0	3.6	1.6	0.56	1.07	0.59	0.378	0.208		
	82.550	29.370	28.575	23.020	0.8	3.2	87.3	117	4 900	6 600	HM801346	HM801310	24.4	51.0	49.0	68.0	78.0	0.8	3.2	0.55	1.10	0.60	0.483	0.282		
	82.550	29.370	28.575	23.020	2.4	3.2	87.3	117	4 900	6 600	HM801346X	HM801310	24.4	54.0	49.0	68.0	78.0	2.4	3.2	0.55	1.10	0.60	0.483	0.282		
	82.931	23.812	25.400	19.050	0.8	0.8	77.2	100	4 800	6 300	25572	25520	17.5	46.0	46.0	74.0	77.0	0.8	0.8	0.33	1.79	0.99	0.437	0.203		
	88.501	26.988	29.083	22.225	3.6	1.6	98.2	112	4 900	6 500	418	414	16.9	51.0	44.5	77.0	80.0	3.6	1.6	0.26	2.28	1.25	0.523	0.325		
	90.488	39.688	40.386	33.338	1.6	3.2	132	169	4 500	6 000	4375	4335	25.6	51.0	48.5	77.0	85.0	1.6	3.2	0.28	2.11	1.16	0.841	0.459		
	101.600	34.925	36.068	26.988	3.6	3.2	131	159	4 000	5 300	525	522	22.2	54.0	48.0	89.0	95.0	3.6	3.2	0.29	2.10	1.16	1.05	0.411		
39.688	73.025	16.667	17.462	12.700	0.8	1.6	45.9	55.8	5 200	6 900	18587	18520	14.5	46.0	46.0	66.0	69.0	0.8	1.6	0.35	1.71	0.94	0.215	0.085		
	73.025	23.812	25.654	19.050	3.6	0.8	74.1	92.2	5 400	7 200	2789R	2735X	15.9	52.0	45.0	66.0	69.0	3.6	0.8	0.30	1.98	1.09	0.288	0.134		
	80.167	29.370	30.391	23.812	0.8	3.2	91.0	106	5 000	6 700	3386	3320	18.7	46.5	45.5	70.0	75.0	0.8	3.2	0.27	2.20	1.21	0.442	0.217		
	84.138	29.370	30.391	23.812	3.6	3.2	91.0	106	5 000	6 700	3382	3328	18.7	52.0	45.5	72.0	76.0	3.6	3.2	0.27	2.20	1.21	0.438	0.312		
40.000	76.200	20.638	20.940	15.507	1.6	1.2	57.3	65.9	5 300	7 000	28158	28300	16.5	47.5	45.0	68.0	71.0	1.6	1.2	0.40	1.49	0.82	0.266	0.137		
	80.000	21.000	22.403	17.826	3.6	1.2	68.0	74.8	4 900	6 600	344	332	15.1	52.0	45.5	73.0	75.0	3.6	1.2	0.27	2.20	1.21	0.334	0.144		

[Note] 1) SP indicates the specially chamfered from.

[Remark] Inch series tapered roller bearings with bore diameter larger than 100 mm are shown in catalog "large size ball & roller bearings".

Single-row tapered roller bearings
inch series

d (40.000) ~ 42.070 mm

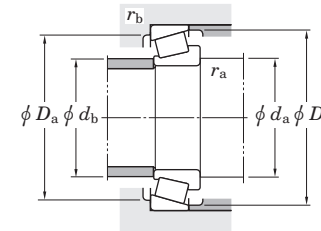
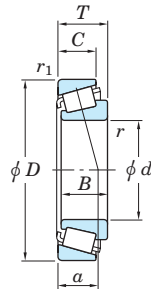

Boundary dimensions (mm)							Basic load ratings (kN)		Limiting speeds (min ⁻¹)		Bearing No.	Load center (mm) <i>a</i>	Mounting dimensions (mm)						Constant <i>e</i>	Axial load factors		(Refer.) Mass (kg)			
<i>d</i>	<i>D</i>	<i>T</i>	<i>B</i>	<i>C</i>	<i>r</i> _{min.}	<i>r</i> _{1 min.}	<i>C</i> _r	<i>C</i> _{0r}	Grease lub.	Oil lub.			Inner ring	Outer ring	<i>d</i> _a	<i>d</i> _b	<i>D</i> _a	<i>D</i> _b		<i>r</i> _{a max.}	<i>r</i> _{b max.}	<i>Y</i> ₁	<i>Y</i> ₀	Inner ring	Outer ring
40.000	80.000	21.000	22.403	17.826	0.8	1.2	68.0	74.8	4 900	6 600	344A	332	15.1	46.0	45.5	73.0	75.0	0.8	1.2	0.27	2.20	1.21	0.334	0.144	
	85.000	20.638	21.692	17.462	0.8	1.2	71.8	81.7	4 600	6 200	350A	354A	15.5	47.5	46.5	77.0	80.0	0.8	1.2	0.31	1.96	1.08	0.416	0.162	
	88.501	26.988	29.083	22.225	3.6	1.6	98.2	112	4 900	6 500	420	414	16.9	52.0	46.0	77.0	80.0	3.6	1.6	0.26	2.28	1.25	0.465	0.325	
	107.950	36.512	36.957	28.575	3.6	3.2	138	172	3 800	5 100	543	532X	23.9	57.0	50.0	94.0	100.0	3.6	3.2	0.30	2.03	1.11	1.17	0.570	
40.483	82.550	29.370	28.575	23.020	3.6	3.2	87.3	117	4 900	6 600	HM801349	HM801310	24.4	58.0	49.0	68.0	78.0	3.6	3.2	0.55	1.10	0.60	0.450	0.282	
41.275	73.025	16.667	17.462	12.700	3.6	1.6	45.9	55.8	5 200	6 900	18590	18520	14.5	53.0	46.0	66.0	69.0	3.6	1.6	0.35	1.71	0.94	0.199	0.085	
	73.431	19.558	19.812	14.732	3.6	0.8	57.8	73.0	5 200	7 000	LM501349	LM501310	16.1	53.0	46.5	67.0	70.0	3.6	0.8	0.40	1.50	0.83	0.227	0.107	
	73.431	21.430	19.812	16.604	3.6	0.8	57.8	73.0	5 200	7 000	LM501349	LM501314	18.0	53.0	46.5	66.0	70.0	3.6	0.8	0.40	1.50	0.83	0.227	0.126	
	73.431	23.012	19.812	18.186	3.6	2.4	57.8	73.0	5 200	7 000	LM501349	LM501311	16.1	53.0	46.5	64.0	70.0	3.6	2.4	0.40	1.50	0.83	0.227	0.140	
	76.200	18.009	17.384	14.288	1.6	1.6	51.6	63.3	5 200	6 900	11162R	11300	17.5	49.0	46.5	67.0	72.0	1.6	1.6	0.49	1.23	0.68	0.221	0.127	
	76.200	22.225	23.020	17.462	3.6	0.8	66.3	83.3	5 200	6 900	24780R	24720	17.4	54.0	47.0	68.0	72.0	3.6	0.8	0.39	1.53	0.84	0.275	0.148	
	80.000	21.000	22.403	17.826	0.8	1.2	68.0	74.8	4 900	6 600	336	332	15.1	47.0	46.0	73.0	75.0	0.8	1.2	0.27	2.20	1.21	0.325	0.144	
	80.000	21.000	22.403	17.826	3.6	1.2	68.0	74.8	4 900	6 600	342	332	15.1	53.0	46.0	73.0	75.0	3.6	1.2	0.27	2.20	1.21	0.317	0.144	
	82.550	26.543	25.654	20.193	3.6	3.2	83.7	105	4 900	6 500	M802048	M802011	23.3	57.0	50.6	70.0	79.0	3.6	3.2	0.55	1.10	0.60	0.403	0.227	
	85.725	30.162	30.162	23.812	3.6	1.2	108	136	4 800	6 400	3877	3821	22.9	57.0	50.3	75.0	81.0	3.6	1.2	0.40	1.49	0.82	0.506	0.324	
	87.312	30.162	30.886	23.812	0.8	3.2	95.8	120	4 600	6 200	3576R	3525	20.5	49.0	48.0	75.0	81.0	0.8	3.2	0.31	1.96	1.08	0.533	0.300	
	88.501	26.988	29.083	22.225	3.6	1.6	98.2	112	4 900	6 500	419	414	16.9	54.0	47.0	77.0	80.0	3.6	1.6	0.26	2.28	1.25	0.441	0.325	
	88.900	20.638	22.225	16.513	3.6	1.2	74.3	87.3	4 400	5 800	365A	362A	16.1	55.0	48.5	81.0	84.0	3.6	1.2	0.32	1.88	1.03	0.458	0.164	
	88.900	30.162	29.370	23.020	0.8	3.2	99.6	125	4 600	6 100	HM803145	HM803110	26.1	54.0	53.0	74.0	85.0	0.8	3.2	0.55	1.10	0.60	0.577	0.318	
	88.900	30.162	29.370	23.020	3.6	3.2	99.6	125	4 600	6 100	HM803146	HM803110	26.1	60.0	53.0	74.0	85.0	3.6	3.2	0.55	1.10	0.60	0.574	0.318	
	90.488	39.688	40.386	33.338	3.6	3.2	132	169	4 500	6 000	4388	4335	25.6	57.0	51.0	77.0	85.0	3.6	3.2	0.28	2.11	1.16	0.775	0.454	
	93.662	31.750	31.750	26.195	0.8	3.2	105	134	4 400	5 800	46162	46368	24.0	52.0	51.0	79.0	87.0	0.8	3.2	0.40	1.49	0.82	0.695	0.403	
	95.250	30.162	29.370	23.020	3.6	3.2	104	140	3 300	4 400	HM804840	HM804810	26.5	61.0	54.0	81.0	91.0	3.6	3.2	0.55	1.10	0.60	0.719	0.351	
	101.600	34.925	36.068	26.988	3.6	3.2	131	159	4 000	5 300	526	522	22.2	57.0	50.0	89.0	95.0	3.6	3.2	0.29	2.10	1.16	1.02	0.411	
	104.775	36.512	36.512	28.575	1.6	3.2	141	195	3 800	5 100	HM807035	HM807010	29.3	60.0	57.0	89.0	100.0	1.6	3.2	0.49	1.23	0.68	1.19	0.497	
	42.070	90.488	39.688	40.386	33.338	3.6	3.2	132	169	4 500	6 000	4395	4335	25.6	58.0	51.0	77.0	85.0	3.6	3.2	0.28	2.11	1.16	0.751	0.459

[Remark] Inch series tapered roller bearings with bore diameter larger than 100 mm are shown in catalog "large size ball & roller bearings".

Single-row tapered roller bearings
inch series

d 42.862 ~ 45.000 mm

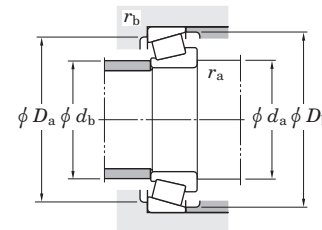
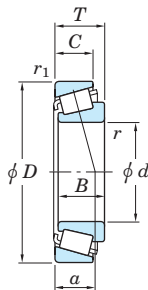

Boundary dimensions (mm)							Basic load ratings (kN)		Limiting speeds (min ⁻¹)		Bearing No.	Load center (mm) a	Mounting dimensions (mm)						Constant e	Axial load factors		(Refer.) Mass (kg)		
d	D	T	B	C	$r_{min.}$	$r_{1 min.}$	C_r	C_{0r}	Grease lub.	Oil lub.			Inner ring	Outer ring	d_a	d_b	D_a	D_b		$r_{a max.}$	$r_{b max.}$	e	Y_1	Y_0
42.862	76.992	17.463	17.145	11.908	1.6	1.6	48.4	62.2	5 000	6 600	12168	12303	17.5	51.0	48.5	68.0	73.0	1.6	1.6	0.51	1.19	0.65	0.220	0.097
42.875	79.375	23.812	25.400	19.050	3.6	0.8	81.1	105	5 000	6 700	26884R 25577	26822 25520	16.1	55.0	48.5	71.0	74.0	3.6	0.8	0.32	1.88	1.04	0.314	0.186
	82.931	23.812	25.400	19.050	3.6	0.8	77.2	100	4 800	6 300			17.5	55.0	49.0	74.0	77.0	3.6	0.8	0.33	1.79	0.99	0.382	0.200
44.450	73.025	18.258	18.258	15.083	1.6	1.6	47.2	65.5	5 100	6 800	L102849 12175 18685 25582 3578R 355 355A HM803149 49175 46175 46176 33885 438 HM804842 HM804843 49576 527 HM807040 535 615	L102810 12303 18620 25520 3520 354A 354A HM803110 49368 46368 46368 33821 432A HM804810 HM804810 49520 522 HM807010 532A 612	14.6	51.0	49.0	66.0	69.0	1.6	1.6	0.32	1.88	1.04	0.183	0.102
	76.992	17.463	17.145	11.908	1.6	1.6	48.4	62.2	5 000	6 600			17.5	52.0	49.5	68.0	73.0	1.6	1.6	0.51	1.19	0.65	0.206	0.097
	79.375	17.462	17.462	13.495	2.8	1.6	47.1	59.1	4 800	6 400			16.0	54.0	49.5	71.0	74.0	2.8	1.6	0.37	1.60	0.88	0.214	0.126
	82.931	23.812	25.400	19.050	5.2	0.8	77.2	100	4 800	6 300			17.5	59.0	51.0	74.0	77.0	5.2	0.8	0.33	1.79	0.99	0.361	0.200
	84.138	30.162	30.886	23.812	3.6	3.2	95.8	120	4 600	6 200			20.5	57.0	51.0	74.0	79.5	3.6	3.2	0.31	1.96	1.08	0.479	0.221
	85.000	20.638	21.692	17.462	2.4	1.2	71.8	81.7	4 600	6 200			15.5	54.0	50.0	77.0	80.0	2.4	1.2	0.31	1.96	1.08	0.344	0.160
	85.000	20.638	21.692	17.462	0.8	1.2	71.8	81.7	4 600	6 200			15.5	51.0	50.0	77.0	80.0	0.8	1.2	0.31	1.96	1.08	0.344	0.160
	88.900	30.162	29.370	23.020	3.6	3.2	99.6	125	4 600	6 100			26.1	62.0	53.4	74.0	85.0	3.6	3.2	0.55	1.10	0.60	0.525	0.318
	93.662	31.750	31.750	25.400	3.6	3.2	105	123	4 400	5 900			22.9	59.0	53.0	82.0	87.0	3.6	3.2	0.36	1.67	0.92	0.645	0.371
	93.662	31.750	31.750	26.195	0.8	3.2	105	134	4 400	5 800			24.0	55.0	54.0	79.0	87.0	0.8	3.2	0.40	1.49	0.82	0.609	0.403
	93.662	31.750	31.750	26.195	3.6	3.2	105	134	4 400	5 800			24.0	60.0	54.0	79.0	87.0	3.6	3.2	0.40	1.49	0.82	0.609	0.403
	95.250	27.783	28.575	22.225	0.8	2.4	108	141	4 100	5 400			20.4	53.0	53.0	85.0	90.0	0.8	2.4	0.33	1.82	1.00	0.714	0.264
	95.250	27.783	29.901	22.225	3.6	0.8	103	122	4 500	5 900			18.4	57.0	51.0	84.0	87.0	3.6	0.8	0.28	2.11	1.16	0.555	0.375
	95.250	30.162	29.370	23.020	0.8	2.4	104	140	3 300	4 400			26.5	57.0	57.0	81.0	91.0	0.8	2.4	0.55	1.10	0.60	0.673	0.351
	95.250	30.162	29.370	23.020	3.6	2.4	104	140	3 300	4 400			26.5	63.0	57.0	81.0	91.0	3.6	2.4	0.55	1.10	0.60	0.670	0.351
	98.425	30.162	31.750	25.400	0.8	3.2	114	143	3 900	5 200			24.1	55.0	54.0	88.0	96.0	0.8	3.2	0.40	1.50	0.82	0.856	0.384
	101.600	34.925	36.068	26.988	3.6	3.2	131	159	4 000	5 300			22.2	59.0	53.0	89.0	95.0	3.6	3.2	0.29	2.10	1.16	0.939	0.411
	104.775	36.512	36.512	28.575	3.6	3.2	141	195	3 800	5 100			29.3	66.0	59.0	89.0	100.0	3.6	3.2	0.49	1.23	0.68	1.13	0.497
111.125	38.100	36.957	30.162	3.6	3.2	138	172	3 800	5 100	23.9	60.0	54.0	95.0	100.0	3.6	3.2	0.30	2.03	1.11	1.09	0.746			
120.650	41.275	41.275	31.750	3.6	3.2	174	217	3 500	4 600	27.3	62.0	56.0	105.0	110.0	3.6	3.2	0.31	1.91	1.05	1.48	0.853			
44.983	93.264	30.162	30.302	23.812	3.6	3.2	103	137	4 200	5 500	3776	3720	22.2	59.0	53.0	82.0	88.0	3.6	3.2	0.34	1.77	0.97	0.650	0.288
45.000	85.000	20.638	21.692	17.462	1.6	1.2	71.8	81.7	4 600	6 200	358	354A	15.5	52.5	50.0	77.0	80.0	1.6	1.2	0.31	1.96	1.08	0.338	0.162

[Remark] Inch series tapered roller bearings with bore diameter larger than 100 mm are shown in catalog "large size ball & roller bearings".

Single-row tapered roller bearings inch series

d 45.242 ~ 49.212 mm

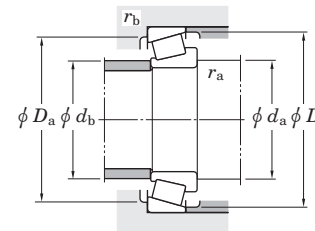
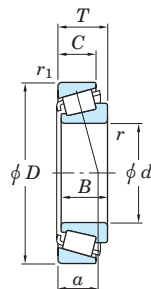

Boundary dimensions (mm)							Basic load ratings (kN)		Limiting speeds (min ⁻¹)		Bearing No.	Load center (mm) a	Mounting dimensions (mm)						Constant e	Axial load factors		(Refer.) Mass (kg)				
d	D	T	B	C	r min.	r1 min.	Cr	C0r	Grease lub.	Oil lub.			Inner ring	Outer ring	da	db	Da	Db		ra max.	rb max.	Y1	Y0	Inner ring	Outer ring	
45.242	73.431	19.558	19.812	15.748	3.6	0.8	55.6	78.1	5 100	6 700	LM102949	LM102910	14.7	56.0	50.0	68.0	70.0	3.6	0.8	0.31	1.97	1.08	0.209	0.100		
	77.788	19.842	19.842	15.080	3.6	0.8	57.1	73.5	4 900	6 500			LM603049	LM603011	17.5	57.0	50.0	71.0	74.0	3.6	0.8	0.43	1.41	0.77	0.243	0.120
	77.788	21.430	19.842	16.667	3.6	0.8	57.1	73.5	4 900	6 500			LM603049	LM603012	19.1	57.0	50.0	71.0	74.0	3.6	0.8	0.43	1.41	0.77	0.243	0.138
	79.974	19.842	19.842	15.080	3.6	0.8	57.1	73.5	4 900	6 500			LM603049	LM603014	17.5	57.0	50.0	71.0	74.0	3.6	0.8	0.43	1.41	0.77	0.243	0.152
45.618	85.000	23.812	25.400	19.050	3.6	2.4	77.2	100	4 800	6 300	25590	25526	17.5	58.0	51.0	74.0	78.0	3.6	2.4	0.33	1.79	0.99	0.344	0.241		
45.987	74.976	18.000	18.000	14.000	2.4	1.6	52.6	74.6	5 000	6 600	LM503349R	LM503310	16.0	53.0	51.0	67.0	72.0	2.4	1.6	0.40	1.49	0.82	0.207	0.095		
46.038	79.375	17.462	17.462	13.495	2.8	1.6	47.1	59.1	4 800	6 400	18690	18620	16.0	56.0	51.0	71.0	74.0	2.8	1.6	0.37	1.60	0.88	0.208	0.123		
	85.000	20.638	21.692	17.462	3.6	1.2	71.8	81.7	4 600	6 200			359A	354A	15.5	57.0	51.0	77.0	80.0	3.6	1.2	0.31	1.96	1.08	0.323	0.160
	85.000	20.638	21.692	17.462	2.4	1.2	71.8	81.7	4 600	6 200			359S	354A	15.5	55.0	51.0	77.0	80.0	2.4	1.2	0.31	1.96	1.08	0.323	0.160
	85.000	25.400	25.608	20.638	3.6	1.2	80.0	106	4 600	6 100			2984	2924	18.9	58.0	52.0	76.0	80.0	3.6	1.2	0.35	1.73	0.95	0.389	0.220
47.625	88.900	20.638	22.225	16.513	3.6	1.2	74.3	87.3	4 400	5 800	369A	362A	16.1	60.0	53.0	81.0	84.0	3.6	1.2	0.32	1.88	1.03	0.373	0.164		
	88.900	25.400	25.400	19.050	3.6	3.2	87.1	112	4 400	5 900			M804049	M804010	23.6	62.0	55.0	76.0	85.0	3.6	3.2	0.55	1.10	0.60	0.450	0.216
	95.250	30.162	29.370	23.020	3.6	3.2	104	140	3 300	4 400			HM804846	HM804810	26.5	64.0	57.0	81.0	91.0	3.6	3.2	0.55	1.10	0.60	0.617	0.351
	96.838	21.000	21.946	15.875	0.8	0.8	80.4	101	3 900	5 200			386A	382A	17.4	56.0	55.0	89.0	92.0	0.8	0.8	0.35	1.69	0.93	0.563	0.177
	101.600	34.925	36.068	26.988	3.6	3.2	131	159	4 000	5 300			528	522	22.2	62.0	55.0	89.0	95.0	3.6	3.2	0.29	2.10	1.16	0.871	0.411
	104.775	30.162	29.317	24.605	4.8	3.2	109	144	3 700	4 900			463	453X	23.6	65.0	56.0	92.0	98.0	4.8	3.2	0.34	1.79	0.98	0.838	0.372
	104.775	30.162	29.317	24.605	0.8	3.2	109	144	3 700	4 900			467	453X	23.6	57.0	56.0	92.0	98.0	0.8	3.2	0.34	1.79	0.98	0.844	0.372
	104.775	30.162	30.958	23.812	3.6	3.2	126	165	3 700	4 900			45282	45220	22.2	64.0	59.0	93.0	99.0	3.6	3.2	0.33	1.80	0.99	0.940	0.345
48.412	95.250	30.162	29.370	23.020	2.4	3.2	104	140	3 300	4 400	HM804848	HM804810	26.5	63.0	57.5	81.0	91.0	2.4	3.2	0.55	1.10	0.60	0.606	0.351		
	95.250	30.162	29.370	23.020	3.6	3.2	104	140	3 300	4 400			HM804849	HM804810	26.5	66.0	57.5	81.0	91.0	3.6	3.2	0.55	1.10	0.60	0.604	0.351
49.212	88.900	20.638	22.225	16.513	0.8	1.2	74.3	87.3	4 400	5 800	365S	362A	16.1	55.0	54.0	81.0	84.0	0.8	1.2	0.32	1.88	1.03	0.366	0.164		
	104.775	36.512	36.512	28.575	3.6	3.2	141	195	3 800	5 100			HM807044	HM807010	29.3	69.0	63.0	89.0	100.0	3.6	3.2	0.49	1.23	0.68	1.03	0.497
	114.300	44.450	44.450	34.925	3.6	3.2	189	230	3 800	5 000			65390	65320	31.7	70.0	60.0	97.0	107.0	3.6	3.2	0.43	1.40	0.77	1.28	0.894
	114.300	44.450	44.450	36.068	3.6	3.2	212	263	3 700	5 000			HH506348	HH506310	30.6	71.0	61.0	97.0	107.0	3.6	3.2	0.40	1.49	0.82	1.49	0.834

[Remark] Inch series tapered roller bearings with bore diameter larger than 100 mm are shown in catalog "large size ball & roller bearings".

Single-row tapered roller bearings inch series

d 49.987 ~ (50.800) mm

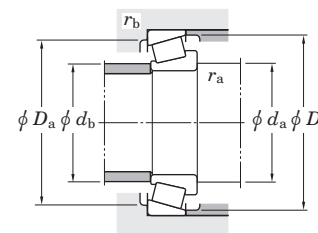
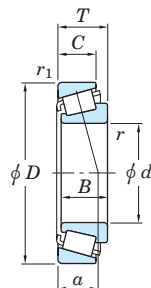

Boundary dimensions (mm)							Basic load ratings (kN)		Limiting speeds (min ⁻¹)		Bearing No. ¹⁾	Load center (mm) a	Mounting dimensions (mm)						Constant e	Axial load factors		(Refer.) Mass (kg)		
d	D	T	B	C	r min.	r ₁ min.	C _r	C _{0r}	Grease lub.	Oil lub.			Inner ring	Outer ring	d _a	d _b	D _a	D _b		r _a max.	r _b max.	Y ₁	Y ₀	Inner ring
49.987	92.075	24.608	25.400	19.845	2.4	0.8	84.8	119	4 200	5 600	28579R	28521	19.9	60.0	56.0	83.0	87.0	2.4	0.8	0.38	1.59	0.87	0.463	0.247
50.000	82.000	21.501	21.501	17.000	3.0	0.5	71.7	97.9	4 500	6 000	JLM104948	JLM104910	16.2	60.0	55.0	76.0	78.0	3.0	0.5	0.31	1.97	1.08	0.304	0.128
	88.900	20.638	22.225	16.513	2.0	1.2	74.3	87.3	4 400	5 800	365	362A	16.1	58.0	55.0	81.0	84.0	2.0	1.2	0.32	1.88	1.03	0.346	0.164
	88.900	20.638	22.225	16.513	2.4	1.2	74.3	87.3	4 400	5 800	366	362A	16.1	59.0	55.0	81.0	84.0	2.4	1.2	0.32	1.88	1.03	0.351	0.166
	90.000	28.000	28.000	23.000	3.0	2.5	105	138	4 300	5 800	JM205149	JM205110	20.2	62.0	57.0	80.0	85.0	3.0	2.5	0.33	1.82	1.00	0.508	0.243
	105.000	37.000	36.000	29.000	3.0	2.8	149	205	3 800	5 100	JHM807045	JHM807012	29.4	69.0	63.0	90.0	100.0	3.0	2.8	0.49	1.23	0.68	1.01	0.523
	110.000	22.000	21.996	18.824	0.8	1.2	86.4	116	3 400	4 500	396	394A	21.3	61.0	60.0	101.0	105.0	0.8	1.2	0.40	1.49	0.82	0.777	0.264
50.800	80.962	18.258	18.258	14.288	1.6	1.6	54.0	81.1	4 600	6 100	L305649R	L305610	16.0	58.0	56.0	73.0	77.0	1.6	1.6	0.35	1.69	0.93	0.228	0.119
	82.550	21.590	22.225	16.510	3.6	1.2	61.2	84.3	4 500	6 000	LM104949	LM104911	16.4	62.0	55.0	75.0	78.0	3.6	1.2	0.31	1.97	1.08	0.287	0.131
	85.725	19.050	18.263	12.700	1.6	1.6	50.7	66.4	4 400	5 900	18200	18337	22.7	59.0	56.0	76.0	81.0	1.6	1.6	0.57	1.06	0.58	0.268	0.134
	88.900	17.462	17.462	13.495	3.6	1.2	49.7	65.5	4 400	5 900	18790	18724	17.4	62.0	56.0	78.0	82.0	3.6	1.2	0.41	1.48	0.81	0.226	0.190
	88.900	20.638	22.225	16.513	1.6	1.2	74.3	87.3	4 400	5 800	368	362A	16.1	58.0	56.0	81.0	84.0	1.6	1.2	0.32	1.88	1.03	0.333	0.164
	88.900	20.638	22.225	16.513	3.6	1.2	74.3	87.3	4 400	5 800	368A	362A	16.1	62.0	56.0	81.0	84.0	3.6	1.2	0.32	1.88	1.03	0.331	0.164
	88.900	20.638	22.225	16.513	5.2	1.2	74.3	87.3	4 400	5 800	370A	362A	16.1	65.0	56.0	81.0	84.0	5.2	1.2	0.32	1.88	1.03	0.326	0.164
	92.075	24.608	25.400	19.845	3.6	0.8	84.8	119	4 200	5 600	28580R	28521	19.9	63.0	57.0	83.0	87.0	3.6	0.8	0.38	1.59	0.87	0.453	0.247
	93.264	20.638	22.225	15.083	2.4	1.2	84.4	98.5	4 200	5 600	375	374	17.1	60.0	57.0	85.0	88.0	2.4	1.2	0.34	1.77	0.97	0.416	0.174
	93.264	30.162	30.302	23.812	3.6	3.2	103	137	4 200	5 500	3780	3720	22.2	64.0	58.0	82.0	88.0	3.6	3.2	0.34	1.77	0.97	0.547	0.288
	93.264	30.162	30.302	23.812	3.6	0.8	103	137	4 200	5 500	3780	3730	22.2	64.0	58.0	84.0	88.0	3.6	0.8	0.34	1.77	0.97	0.547	0.293
	95.250	27.783	28.575	22.225	3.6	0.8	108	141	4 100	5 400	33889	33822	20.4	64.0	58.0	86.0	90.0	3.6	0.8	0.33	1.82	1.00	0.604	0.267
	96.838	21.000	21.946	15.875	0.8	0.8	80.4	101	3 900	5 200	385AX	382A	17.4	59.0	58.0	89.0	92.0	0.8	0.8	0.35	1.69	0.93	0.521	0.177
	97.630	24.608	24.608	19.446	3.6	0.8	89.6	131	3 900	5 200	28678	28622	21.2	65.0	58.0	88.0	92.0	3.6	0.8	0.40	1.49	0.82	0.569	0.267
	98.425	30.162	30.302	23.812	3.6	3.2	103	137	4 200	5 500	3780	3732	22.2	64.0	58.0	84.0	90.0	3.6	3.2	0.34	1.77	0.97	0.547	0.433
	101.600	31.750	31.750	25.400	3.6	3.2	114	143	3 900	5 200	49585	49520	24.1	66.0	59.0	88.0	96.0	3.6	3.2	0.40	1.50	0.82	0.736	0.384
	101.600	34.925	36.068	26.988	0.8	3.2	131	159	4 000	5 300	529	522	22.2	59.0	58.0	89.0	95.0	0.8	3.2	0.29	2.10	1.16	0.806	0.411
	101.600	34.925	36.068	26.988	3.6	3.2	131	159	4 000	5 300	529X	522	22.2	65.0	58.0	89.0	95.0	3.6	3.2	0.29	2.10	1.16	0.802	0.411
	104.775	30.162	30.958	23.812	6.4	3.2	126	165	3 700	4 900	45284	45220	22.2	71.0	59.0	93.0	99.0	6.4	3.2	0.33	1.80	0.99	0.873	0.345
	104.775	36.512	36.512	28.575	3.6	3.2	148	187	3 900	5 100	59200	59412	26.9	68.0	61.0	92.0	99.0	3.6	3.2	0.40	1.49	0.82	0.767	0.623

[Note] 1) To the bearings with supplementary code "J" attached at the front of bearing number, tolerances shown in table 7-8 on page A66 are applied.

[Remark] Inch series tapered roller bearings with bore diameter larger than 100 mm are shown in catalog "large size ball & roller bearings".

Single-row tapered roller bearings
inch series

d (50.800) ~ (55.000) mm

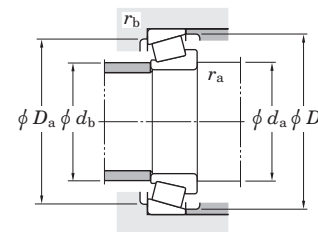
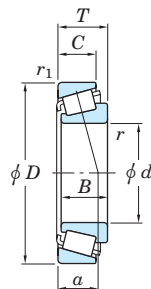

Boundary dimensions (mm)							Basic load ratings (kN)		Limiting speeds (min ⁻¹)		Bearing No. ¹⁾	Load center (mm) a	Mounting dimensions (mm)						Constant e	Axial load factors		(Refer.) Mass (kg)				
d	D	T	B	C	r _{min.}	r _{1 min.}	C _r	C _{0r}	Grease lub.	Oil lub.			Inner ring	Outer ring	d _a	d _b	D _a	D _b		r _{a max.}	r _{b max.}	Y ₁	Y ₀	Inner ring	Outer ring	
50.800	104.775	36.512	36.512	28.575	3.6	3.2	141	195	3 800	5 100	HM807046	HM807010	29.3	70.0	63.0	89.0	100.0	3.6	3.2	0.49	1.23	0.68	0.995	0.497		
	104.775	39.688	40.157	33.338	3.6	3.2	151	211	3 800	5 100			4580	4535	27.3	67.0	61.0	90.0	99.0	3.6	3.2	0.34	1.79	0.98	1.06	0.576
	107.950	36.512	36.957	28.575	3.6	3.2	138	172	3 800	5 100			537	532X	23.9	65.0	59.0	94.0	100.0	3.6	3.2	0.30	2.03	1.11	0.969	0.569
	112.712	30.162	30.162	23.812	3.6	3.2	147	207	3 300	4 500			39575	39520	23.3	68.0	61.0	101.0	107.0	3.6	3.2	0.34	1.77	0.97	1.13	0.355
	120.650	41.275	41.275	31.750	3.6	3.2	174	217	3 500	4 600			619	612	27.3	67.0	61.0	105.0	110.0	3.6	3.2	0.31	1.91	1.05	1.44	0.853
	127.000	44.450	44.450	34.925	3.6	3.2	208	269	3 300	4 400			65200	65500	35.2	75.0	69.0	107.0	119.0	3.6	3.2	0.49	1.23	0.68	1.86	1.03
	51.592	88.900	20.638	22.225	16.513	2.0	1.2	74.3	87.3	4 400			5 800	368S	362A	16.1	59.0	56.0	81.0	84.0	2.0	1.2	0.32	1.88	1.03	0.321
52.388	92.075	24.608	25.400	19.845	3.6	0.8	84.8	119	4 200	5 600	28584R	28521	19.9	65.0	58.0	83.0	87.0	3.6	0.8	0.38	1.59	0.87	0.435	0.247		
	104.775	30.162	29.317	24.605	1.6	3.2	109	144	3 700	4 900			468	453X	23.6	62.0	60.0	92.0	98.0	1.6	3.2	0.34	1.79	0.98	0.748	0.372
53.975	88.900	19.050	19.050	13.492	2.4	2.0	62.9	86.8	4 200	5 600	LM806649	LM806610	21.5	63.0	60.0	80.0	85.0	2.4	2.0	0.55	1.10	0.60	0.312	0.135		
	95.250	27.783	28.575	22.225	1.6	0.8	108	141	4 100	5 400			33895	33822	20.4	63.0	60.0	86.0	90.0	1.6	0.8	0.33	1.82	1.00	0.550	0.267
	104.775	30.162	29.317	24.605	3.6	3.2	109	144	3 700	4 900			456	453X	23.6	68.0	61.0	92.0	98.0	3.6	3.2	0.34	1.79	0.98	0.728	0.372
	104.775	36.512	36.512	28.575	3.6	3.2	141	195	3 800	5 100			HM807049	HM807010	29.3	73.0	63.0	89.0	100.0	3.6	3.2	0.49	1.23	0.68	0.921	0.497
	104.775	39.688	40.157	33.338	3.6	3.2	151	211	3 800	5 100			4595	4535	27.3	70.0	63.0	90.0	99.0	3.6	3.2	0.34	1.79	0.98	0.981	0.576
	107.950	36.512	36.957	28.575	3.6	3.2	138	172	3 800	5 100			539	532X	23.9	68.0	61.0	94.0	100.0	3.6	3.2	0.30	2.03	1.11	0.894	0.569
	107.950	36.512	36.957	28.575	5.6	3.2	138	172	3 800	5 100			539A	532X	23.9	72.0	61.0	94.0	100.0	5.6	3.2	0.30	2.03	1.11	0.861	0.569
	117.475	33.338	31.750	23.812	3.6	3.2	129	152	3 500	4 600			66212R	66462	33.2	73.0	67.0	100.0	111.0	3.6	3.2	0.63	0.96	0.53	1.03	0.552
	120.650	41.275	41.275	31.750	3.6	3.2	174	217	3 500	4 600			621	612	27.3	70.0	63.0	105.0	110.0	3.6	3.2	0.31	1.91	1.05	1.36	0.853
	122.238	33.338	31.750	23.812	3.6	3.2	128	153	3 300	4 300			66584	66520	35.4	75.0	68.0	105.0	116.0	3.6	3.2	0.67	0.90	0.50	1.25	0.551
	122.238	43.658	43.764	36.512	3.6	3.2	221	318	3 200	4 300			5578R	5535	31.1	73.0	67.0	106.0	116.0	3.6	3.2	0.36	1.67	0.92	1.84	0.807
	123.825	38.100	36.678	30.162	3.6	3.2	162	223	3 200	4 200			557S	552A	28.7	71.0	65.0	109.0	116.0	3.6	3.2	0.35	1.73	0.95	1.47	0.756
	127.000	44.450	44.450	34.925	3.6	3.2	208	269	3 300	4 400			65212	65500	35.2	77.0	71.0	107.0	119.0	3.6	3.2	0.49	1.23	0.68	1.78	1.02
54.988	104.775	30.162	29.317	24.605	2.4	3.2	109	144	3 700	4 900	466	453X	23.6	67.0	61.0	92.0	98.0	2.4	3.2	0.34	1.79	0.98	0.708	0.372		
54.991	135.755	53.975	56.007	44.450	3.6	3.2	266	357	3 000	4 000	6381	6320	34.8	76.0	70.0	117.0	126.0	3.6	3.2	0.32	1.85	1.02	2.75	1.37		
55.000	90.000	23.000	23.000	18.500	1.6	0.5	81.4	115	4 200	5 500	JLM506849	JLM506810	20.1	63.0	61.0	82.0	86.0	1.6	0.5	0.40	1.49	0.82	0.370	0.183		

[Note] 1) To the bearings with supplementary code "J" attached at the front of bearing number, tolerances shown in table 7-8 on page A66 are applied.

[Remark] Inch series tapered roller bearings with bore diameter larger than 100 mm are shown in catalog "large size ball & roller bearings".

Single-row tapered roller bearings
inch series

d (55.000) ~ (60.000) mm

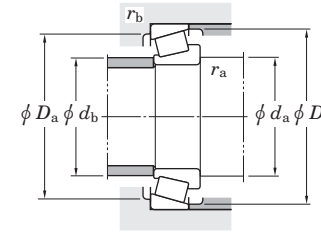
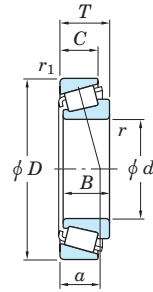

Boundary dimensions (mm)							Basic load ratings (kN)		Limiting speeds (min ⁻¹)		Load center (mm) a	Mounting dimensions (mm)						Constant e	Axial load factors		(Refer.) Mass (kg)			
d	D	T	B	C	r _{min.}	r _{1 min.}	C _r	C _{0r}	Grease lub.	Oil lub.		Inner ring	Outer ring	d _a	d _b	D _a	D _b		r _{a max.}	r _{b max.}	Y ₁	Y ₀	Inner ring	Outer ring
55.000	95.000	29.000	29.000	23.500	1.6	2.8	110	150	4 000	5 300	JM207049	JM207010	21.3	64.0	62.0	85.0	91.0	1.6	2.8	0.33	1.79	0.99	0.567	0.256
	96.838	21.000	21.946	15.875	2.4	0.8	80.4	101	3 900	5 200	385	382A	17.4	65.0	61.0	89.0	92.0	2.4	0.8	0.35	1.69	0.93	0.461	0.177
	96.838	21.000	21.946	15.875	3.6	0.8	80.4	101	3 900	5 200	385X	382A	17.4	67.0	61.0	89.0	92.0	3.6	0.8	0.35	1.69	0.93	0.459	0.177
	110.000	39.000	39.000	32.000	3.0	2.5	176	224	3 600	4 900	JH307749	JH307710	26.8	71.0	64.0	97.0	104.0	3.0	2.5	0.35	1.73	0.95	1.16	0.560
55.562	97.630	24.608	24.608	19.446	3.6	0.8	89.6	131	3 900	5 200	28680	28622	21.2	68.0	62.0	88.0	92.0	3.6	0.8	0.40	1.49	0.82	0.492	0.267
	122.238	43.658	43.764	36.512	1.2	3.2	221	318	3 200	4 300	5566R	5535	31.1	70.0	68.0	106.0	116.0	1.2	3.2	0.36	1.67	0.92	1.82	0.807
	127.000	36.512	36.512	26.988	3.6	3.2	166	235	3 000	4 000	HM813840	HM813810	32.9	76.0	70.0	111.0	121.0	3.6	3.2	0.50	1.20	0.66	1.72	0.606
55.575	96.838	21.000	21.946	15.875	2.4	0.8	80.4	101	3 900	5 200	389	382A	17.4	65.0	61.0	89.0	92.0	2.4	0.8	0.35	1.69	0.93	0.452	0.177
57.150	96.838	21.000	21.946	15.875	2.4	0.8	80.4	101	3 900	5 200	387	382A	17.4	66.0	62.0	89.0	92.0	2.4	0.8	0.35	1.69	0.93	0.428	0.177
	96.838	21.000	21.946	15.875	3.6	0.8	80.4	101	3 900	5 200	387A	382A	17.4	69.0	62.0	89.0	92.0	3.6	0.8	0.35	1.69	0.93	0.426	0.177
	96.838	21.000	21.946	15.875	5.2	0.8	80.4	101	3 900	5 200	387AS	382A	17.4	72.0	62.0	89.0	92.0	5.2	0.8	0.35	1.69	0.93	0.422	0.177
	96.838	21.000	21.946	15.875	0.8	0.8	80.4	101	3 900	5 200	387S	382A	17.4	63.0	62.0	89.0	92.0	0.8	0.8	0.35	1.69	0.93	0.431	0.177
	98.425	21.000	21.946	17.826	2.4	0.8	80.4	101	3 900	5 200	387	382	17.4	66.0	62.0	89.0	92.0	2.4	0.8	0.35	1.69	0.93	0.428	0.223
	104.775	30.162	29.317	24.605	2.4	3.2	109	144	3 700	4 900	462	453X	23.6	67.0	63.0	92.0	98.0	2.4	3.2	0.34	1.79	0.98	0.685	0.372
	104.775	30.162	29.317	24.605	3.6	3.2	109	144	3 700	4 900	469	453X	23.6	70.0	63.0	92.0	98.0	3.6	3.2	0.34	1.79	0.98	0.682	0.372
	104.775	30.162	30.958	23.812	6.4	0.8	126	165	3 700	4 900	45291	45221	22.2	76.0	65.0	95.0	99.0	6.4	0.8	0.33	1.80	0.99	0.742	0.350
	112.712	30.162	30.048	23.812	3.6	3.2	111	164	3 400	4 500	3979	3920	25.9	72.0	66.0	99.0	106.0	3.6	3.2	0.40	1.49	0.82	0.916	0.448
	112.712	30.162	30.162	23.812	3.6	3.2	147	207	3 300	4 500	39580	39520	23.3	72.0	66.0	101.0	107.0	3.6	3.2	0.34	1.77	0.97	1.05	0.355
	112.712	30.162	30.162	23.812	7.9	3.2	147	207	3 300	4 500	39581	39520	23.3	81.0	66.0	101.0	107.0	7.9	3.2	0.34	1.77	0.97	1.03	0.355
	117.475	30.162	30.162	23.812	3.6	3.2	118	179	3 200	4 200	33225	33462	27.8	74.0	68.0	104.0	112.0	3.6	3.2	0.44	1.38	0.76	1.13	0.442
	120.650	41.275	41.275	31.750	3.6	3.2	174	217	3 500	4 600	623	612	27.3	72.0	66.0	105.0	110.0	3.6	3.2	0.31	1.91	1.05	1.27	0.853
	127.000	44.450	44.450	34.925	3.6	3.2	208	269	3 300	4 400	65225	65500	35.2	80.0	71.0	107.0	119.0	3.6	3.2	0.49	1.23	0.68	1.69	1.02
57.531	96.838	21.000	21.946	15.875	3.6	0.8	80.4	101	3 900	5 200	388A	382A	17.4	69.0	63.0	89.0	92.0	3.6	0.8	0.35	1.69	0.93	0.420	0.177
59.972	122.238	33.338	31.750	23.812	0.8	3.2	128	153	3 300	4 300	66589	66520	35.4	74.0	73.0	105.0	116.0	0.8	3.2	0.67	0.90	0.50	1.11	0.551
60.000	95.000	24.000	24.000	19.000	5.0	2.5	86.1	125	3 900	5 200	JLM508748	JLM508710	21.2	75.0	66.0	85.0	91.0	5.0	2.5	0.40	1.49	0.82	0.402	0.196

[Note] 1) To the bearings with supplementary code "J" attached at the front of bearing number, tolerances shown in table 7-8 on page A66 are applied.

[Remark] Inch series tapered roller bearings with bore diameter larger than 100 mm are shown in catalog "large size ball & roller bearings".

Single-row tapered roller bearings
inch series

d (60.000) ~ (65.000) mm

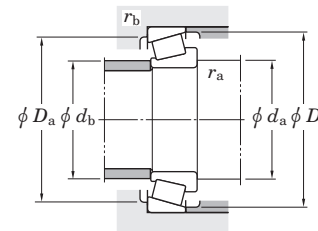
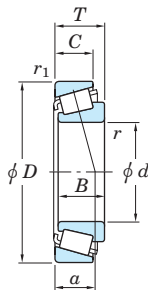

Boundary dimensions (mm)							Basic load ratings (kN)		Limiting speeds (min ⁻¹)		Bearing No. ¹⁾	Load center (mm) a	Mounting dimensions (mm)					Con-stant e	Axial load factors		(Refer.) Mass (kg)			
d	D	T	B	C	$r_{min.}$	$r_{1min.}$	C_r	C_{0r}	Grease lub.	Oil lub.			Inner ring	Outer ring	d_a	d_b	D_a		D_b	$r_{a max.}$	$r_{b max.}$	e	Y_1	Y_0
60.000	107.950	25.400	25.400	19.050	3.6	3.2	92.8	143	3 400	4 500	29580 397	29520 394A	24.7	74.0	68.0	96.0	103.0	3.6	3.2	0.46	1.31	0.72	0.713	0.277
	110.000	22.000	21.996	18.824	0.8	1.2	86.4	116	3 400	4 500			21.3	69.0	68.0	101.0	104.5	0.8	1.2	0.40	1.49	0.82	0.637	0.259
60.325	100.000	25.400	25.400	19.845	3.6	3.2	91.4	137	3 700	4 900	28985 28985 5583R HM813841 HM813841A 65237 65237A H715332	28921 28920 5535 HM813811 HM813810 65500 65500 H715311	22.8	73.0	67.0	89.0	96.0	3.6	3.2	0.43	1.41	0.78	0.533	0.230
	101.600	25.400	25.400	19.845	3.6	3.2	91.4	137	3 700	4 900			22.8	73.0	67.0	89.0	96.0	3.6	3.2	0.43	1.41	0.78	0.533	0.269
	122.238	43.658	43.764	36.512	3.6	3.2	221	318	3 200	4 300			31.1	78.0	72.0	106.0	116.0	3.6	3.2	0.36	1.67	0.92	1.66	0.807
	127.000	36.512	36.512	26.988	3.6	1.6	166	235	3 000	4 000			32.9	80.0	73.0	113.0	121.0	3.6	1.6	0.50	1.20	0.66	1.60	0.622
	127.000	36.512	36.512	26.988	1.6	3.2	166	235	3 000	4 000			32.9	74.0	71.0	110.0	121.0	1.6	3.2	0.50	1.20	0.66	1.62	0.606
	127.000	44.450	44.450	34.925	3.6	3.2	208	269	3 300	4 400			35.2	82.0	71.0	107.0	119.0	3.6	3.2	0.49	1.23	0.68	1.59	1.02
	127.000	44.450	44.450	34.925	1.6	3.2	208	269	3 300	4 400			35.2	78.0	71.0	107.0	119.0	1.6	3.2	0.49	1.23	0.68	1.59	1.02
	136.525	46.038	46.038	36.512	3.6	3.2	231	369	2 800	3 700			37.0	84.0	78.0	118.0	132.0	3.6	3.2	0.47	1.27	0.70	2.56	0.950
61.912	110.000	22.000	21.996	18.824	0.8	1.2	86.4	116	3 400	4 500	392	394A	21.3	70.0	69.0	101.0	104.5	0.8	1.2	0.40	1.49	0.82	0.606	0.259
63.500	107.950	25.400	25.400	19.050	1.6	3.2	92.8	143	3 400	4 500	29586 390A 395 29585 39585 477 HM212046 5584R 565 6382 H414235	29520 394A 394A 29521 39520 472 HM212011 5535 563 6320 H414210	24.7	73.0	71.0	96.0	103.0	1.6	3.2	0.46	1.31	0.72	0.649	0.277
	110.000	22.000	21.996	18.824	1.6	1.2	86.4	116	3 400	4 500			21.3	73.0	70.0	101.0	104.5	1.6	1.2	0.40	1.49	0.82	0.579	0.259
	110.000	22.000	21.996	18.824	3.6	1.2	86.4	116	3 400	4 500			21.3	77.0	70.0	101.0	104.5	3.6	1.2	0.40	1.49	0.82	0.575	0.259
	110.000	25.400	25.400	19.050	3.6	1.2	92.8	143	3 400	4 500			24.7	77.0	71.0	99.0	104.0	3.6	1.2	0.46	1.31	0.72	0.644	0.333
	112.712	30.162	30.162	23.812	3.6	3.2	147	207	3 300	4 500			23.3	77.0	71.0	101.0	107.0	3.6	3.2	0.34	1.77	0.97	0.908	0.355
	120.000	29.794	29.007	24.237	0.8	2.0	118	161	3 200	4 200			25.7	73.0	72.0	108.0	113.0	0.8	2.0	0.38	1.56	0.86	0.967	0.493
	122.238	38.354	38.100	29.718	3.6	3.2	191	249	3 200	4 300			27.6	80.0	73.0	108.0	116.0	3.6	3.2	0.34	1.78	0.98	1.36	0.591
	122.238	43.658	43.764	36.512	3.6	3.2	221	318	3 200	4 300			31.1	81.0	75.0	106.0	116.0	3.6	3.2	0.36	1.67	0.92	1.56	0.807
	127.000	36.512	36.170	28.575	3.6	3.2	156	226	3 000	4 000			28.6	80.0	73.0	112.0	120.0	3.6	3.2	0.36	1.65	0.91	1.43	0.648
	135.755	53.975	56.007	44.450	4.3	3.2	266	357	3 000	4 000			34.8	84.0	77.0	117.0	126.0	4.3	3.2	0.32	1.85	1.02	2.29	1.39
	136.525	41.275	41.275	31.750	3.6	3.2	241	308	2 900	3 800			30.3	82.0	78.0	121.0	129.0	3.6	3.2	0.36	1.67	0.92	2.11	0.796
	64.986	112.712	30.162	30.924	23.812	2.4	3.2	147	207	3 300			4 500	39586 39520	39520	23.3	76.0	72.0	101.0	107.0	2.4	3.2	0.34	1.77
110.000		28.000	28.000	22.500	3.0	2.8	136	191	3 400	4 600	24.5	78.0	72.0			99.0	105.0	3.0	2.8	0.40	1.49	0.82	0.733	0.338
65.000	105.000	24.000	23.000	18.500	3.0	1.0	95.3	129	3 500	4 700	JLM710949 JM511946	JLM710910 JM511910	23.8	77.0	71.0	96.0	100.5	3.0	1.0	0.45	1.32	0.73	0.513	0.234
	110.000	28.000	28.000	22.500	3.0	2.8	136	191	3 400	4 600			24.5	78.0	72.0	99.0	105.0	3.0	2.8	0.40	1.49	0.82	0.733	0.338

[Note] 1) To the bearings with supplementary code "J" attached at the front of bearing number, tolerances shown in table 7-8 on page A66 are applied.

[Remark] Inch series tapered roller bearings with bore diameter larger than 100 mm are shown in catalog "large size ball & roller bearings".

Single-row tapered roller bearings inch series

d (65.000) ~ 68.262 mm

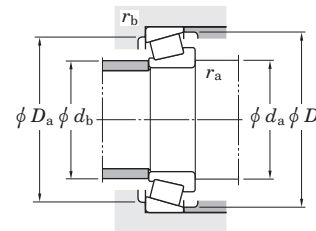
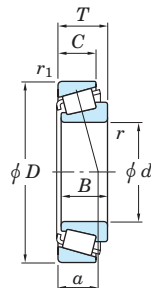

Boundary dimensions (mm)							Basic load ratings (kN)		Limiting speeds (min ⁻¹)		Bearing No. ¹⁾	Load center (mm) a	Mounting dimensions (mm)						Con-stant e	Axial load factors		(Refer.) Mass (kg)					
d	D	T	B	C	r min.	r_1 min.	C_r	C_{0r}	Grease lub.	Oil lub.			Inner ring	Outer ring	d_a	d_b	D_a	D_b		r_a max.	r_b max.	Y_1	Y_0	Inner ring	Outer ring		
65.000	120.000	39.000	38.500	32.000	3.0	2.8	189	255	3 200	4 300	JH211749	JH211710	27.9	80.0	74.0	107.0	114.0	3.0	2.8	0.34	1.78	0.98	1.27	0.618			
	120.000	39.000	38.500	32.000	7.1	2.8	189	255	3 200	4 300			JH211749A	JH211710	27.9	88.0	74.0	107.0	114.0	7.1	2.8	0.34	1.78	0.98	1.27	0.618	
65.088	135.755	53.975	56.007	44.450	3.6	3.2	266	357	3 000	4 000	6379	6320	34.8	84.0	77.5	117.0	126.0	3.6	3.2	0.32	1.85	1.02	2.34	1.37			
	136.525	46.038	46.038	36.512	3.6	3.2	231	369	2 800	3 700			H715340	H715311	37.0	88.0	82.0	118.0	132.0	3.6	3.2	0.47	1.27	0.70	2.39	0.950	
65.883	122.238	43.658	43.764	36.512	3.6	3.2	221	318	3 200	4 300	5595R	5535	31.1	83.0	77.0	106.0	116.0	3.6	3.2	0.36	1.67	0.92	1.48	0.807			
66.675	110.000	22.000	21.996	18.824	0.8	1.2	86.4	116	3 400	4 500	395A	394A	21.3	73.0	73.0	101.0	104.5	0.8	1.2	0.40	1.49	0.82	0.524	0.259			
	110.000	22.000	21.996	18.824	3.6	1.2	86.4	116	3 400	4 500			395S	394A	21.3	79.0	73.0	101.0	104.5	3.6	1.2	0.40	1.49	0.82	0.519	0.259	
	112.712	30.162	30.048	23.812	3.6	0.8	111	164	3 400	4 500			3984	3925	25.9	80.0	74.0	101.0	106.0	3.6	0.8	0.40	1.49	0.82	0.700	0.454	
	112.712	30.162	30.162	23.812	3.6	3.2	147	207	3 300	4 500	39590	39520	23.3	80.0	74.0	101.0	107.0	3.6	3.2	0.34	1.77	0.97	0.832	0.355			
	112.712	30.162	30.162	23.812	3.6	0.8	147	207	3 300	4 500			39590	39521	23.3	80.0	74.0	103.0	107.0	3.6	0.8	0.34	1.77	0.97	0.832	0.360	
	117.475	30.162	30.162	23.812	3.6	3.2	118	179	3 200	4 200			33262	33462	27.8	81.0	75.0	104.0	112.0	3.6	3.2	0.44	1.38	0.76	0.910	0.436	
	122.238	38.100	38.354	29.718	3.6	1.6	191	249	3 200	4 300	HM212049	HM212010	27.3	82.0	75.5	110.0	116.0	3.6	1.6	0.34	1.78	0.98	1.26	0.596			
	127.000	36.512	36.512	26.988	3.6	1.6	166	235	3 000	4 000	HM813844	HM813811	32.9	85.0	78.0	113.0	121.0	3.6	1.6	0.50	1.20	0.66	1.42	0.622			
	130.175	41.275	41.275	31.750	3.6	3.2	197	267	3 000	3 900	641	633	30.3	83.0	77.0	116.0	124.0	3.6	3.2	0.36	1.66	0.91	1.68	0.703			
	135.755	53.975	56.007	44.450	4.3	3.2	266	357	3 000	4 000	6386	6320	34.8	87.0	77.5	117.0	126.0	4.3	3.2	0.32	1.85	1.02	2.27	1.37			
	135.755	53.975	56.007	44.450	6.4	3.2	266	357	3 000	4 000	6389	6320	34.8	91.0	77.5	117.0	126.0	6.4	3.2	0.32	1.85	1.02	2.15	1.37			
	136.525	41.275	41.275	31.750	3.6	3.2	241	308	2 900	3 800	H414242	H414210	30.3	85.0	81.0	121.0	129.0	3.6	3.2	0.36	1.67	0.92	2.01	0.796			
	136.525	46.038	46.038	36.512	3.6	3.2	231	369	2 800	3 700	H715341	H715311	37.0	89.0	83.0	118.0	132.0	3.6	3.2	0.47	1.27	0.70	2.33	0.950			
	68.262	110.000	22.000	21.996	18.824	2.4	1.2	86.4	116	3 400	4 500	399A	394A	21.3	78.0	74.0	101.0	104.5	2.4	1.2	0.40	1.49	0.82	0.493	0.259		
		110.000	22.000	21.996	18.824	5.2	1.2	86.4	116	3 400	4 500			399AS	394A	21.3	83.0	74.0	101.0	104.5	5.2	1.2	0.40	1.49	0.82	0.485	0.259
		117.475	30.162	30.162	23.812	3.6	3.2	118	179	3 200	4 200			33269	33462	27.8	82.0	76.0	104.0	112.0	3.6	3.2	0.44	1.38	0.76	0.870	0.436
127.000		36.512	36.170	28.575	3.6	3.2	156	226	3 000	4 000	570	563	28.6	83.0	77.0	112.0	120.0	3.6	3.2	0.36	1.65	0.91	1.29	0.648			
136.525		41.275	41.275	31.750	3.6	3.2	241	308	2 900	3 800	H414245	H414210	30.3	86.0	82.0	121.0	129.0	3.6	3.2	0.36	1.67	0.92	1.92	0.788			
136.525		46.038	46.038	36.512	3.6	3.2	231	369	2 800	3 700	H715343	H715311	37.0	90.0	84.0	118.0	132.0	3.6	3.2	0.47	1.27	0.70	2.27	0.950			
152.400		47.625	46.038	31.750	3.6	3.2	244	278	2 700	3 600	9185	9121	44.5	94.0	81.5	130.0	145.0	3.6	3.2	0.66	0.91	0.50	2.67	1.20			

[Note] 1) To the bearings with supplementary code "J" attached at the front of bearing number, tolerances shown in table 7-8 on page A66 are applied.

[Remark] Inch series tapered roller bearings with bore diameter larger than 100 mm are shown in catalog "large size ball & roller bearings".

Single-row tapered roller bearings
inch series

d 69.850 ~ (73.025) mm

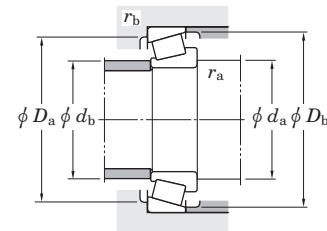
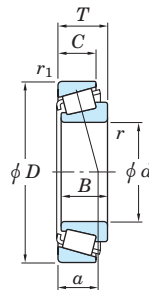

Boundary dimensions (mm)							Basic load ratings (kN)		Limiting speeds (min ⁻¹)		Bearing No. 1)	Load center (mm) a	Mounting dimensions (mm)					Con-stant e	Axial load factors		(Refer.) Mass (kg)			
d	D	T	B	C	r _{min.}	r _{1 min.}	C _r	C _{0r}	Grease lub.	Oil lub.			Inner ring	Outer ring	d _a	d _b	D _a		D _b	r _{a max.}	r _{b max.}	Y ₁	Y ₀	Inner ring
69.850	98.425	13.495	13.495	9.525	1.6	1.6	39.3	59.8	3 500	4 700	LL713049	LL713010	18.4	77.0	74.0	92.0	94.0	1.6	1.6	0.44	1.37	0.75	0.205	0.086
	112.712	22.225	21.996	15.875	1.6	0.8	91.6	127	3 300	4 400	LM613449	LM613410	21.9	78.0	76.0	104.0	107.0	1.6	0.8	0.42	1.44	0.79	0.562	0.238
	112.712	25.400	25.400	19.050	1.6	3.2	97.0	155	3 200	4 300	29675	29620	26.2	80.0	77.0	101.0	109.0	1.6	3.2	0.49	1.23	0.68	0.676	0.270
	117.475	30.162	30.162	23.812	3.6	3.2	118	179	3 200	4 200	33275	33462	27.8	84.0	77.0	104.0	112.0	3.6	3.2	0.44	1.38	0.76	0.830	0.436
	120.000	29.002	29.007	23.444	3.6	3.2	118	161	3 200	4 200	482	472A	24.9	83.0	77.0	106.0	114.0	3.6	3.2	0.38	1.56	0.86	0.791	0.462
	120.000	29.794	29.007	24.237	3.6	2.0	118	161	3 200	4 200	482	472	25.7	83.0	77.0	108.0	113.0	3.6	2.0	0.38	1.56	0.86	0.791	0.487
	120.000	32.545	32.545	26.195	3.6	3.2	150	218	3 100	4 200	47487R	47420	26.6	84.0	78.0	107.0	114.0	3.6	3.2	0.36	1.67	0.92	1.01	0.476
	120.650	32.545	32.545	26.195	3.6	0.8	150	218	3 100	4 200	47487R	47423	26.6	84.0	78.0	109.0	114.0	3.6	0.8	0.36	1.67	0.92	1.01	0.513
	123.825	30.162	29.007	24.605	3.6	3.2	118	161	3 200	4 200	482	472X	26.0	83.0	77.0	109.0	114.0	3.6	3.2	0.38	1.56	0.86	0.791	0.625
	127.000	36.512	36.170	28.575	3.6	3.2	156	226	3 000	4 000	566	563	28.6	85.0	78.0	112.0	120.0	3.6	3.2	0.36	1.65	0.91	1.24	0.648
	146.050	41.275	41.275	31.750	3.6	3.2	208	301	2 600	3 400	655	653	33.4	88.0	82.0	131.0	139.0	3.6	3.2	0.41	1.47	0.81	2.35	0.891
	150.089	44.450	46.672	36.512	3.6	3.2	264	368	2 500	3 400	745AR	742	32.4	88.0	82.0	134.0	142.0	3.6	3.2	0.33	1.84	1.01	2.79	1.07
	168.275	53.975	56.363	41.275	3.6	3.2	344	467	2 300	3 100	835R	832	35.0	91.0	84.0	149.0	155.0	3.6	3.2	0.30	2.00	1.10	4.32	1.72
	69.952	121.442	24.608	23.012	17.462	2.0	2.0	90.0	127	3 000	4 000	34274	34478	26.8	81.0	78.0	110.0	116.0	2.0	2.0	0.45	1.33	0.73	0.764
115.000		29.000	29.000	23.000	3.0	2.5	123	173	3 200	4 300	JLM813049	JLM813010	26.1	78.0	77.0	98.0	105.0	1.0	2.5	0.49	1.23	0.68	0.590	0.300
70.000	110.000	26.000	25.000	20.500	1.0	2.5	103	158	3 300	4 400	JM612949	JM612910	26.2	83.0	77.0	103.0	110.0	3.0	2.5	0.43	1.39	0.77	0.776	0.358
	117.475	30.162	30.162	23.812	3.6	3.2	118	179	3 200	4 200	33281	33462	27.8	85.0	79.0	104.0	112.0	3.6	3.2	0.44	1.38	0.76	0.789	0.436
	120.000	32.545	32.545	26.195	3.6	3.2	150	218	3 100	4 200	47490R	47420	26.6	86.0	79.0	107.0	114.0	3.6	3.2	0.36	1.67	0.92	0.964	0.476
	127.000	36.512	36.170	28.575	3.6	3.2	156	226	3 000	4 000	567A	563	28.6	86.0	80.0	112.0	120.0	3.6	3.2	0.36	1.65	0.91	1.19	0.648
	127.000	36.512	36.512	26.988	3.6	1.6	166	235	3 000	4 000	HM813849	HM813811	32.9	89.0	81.9	113.0	121.0	3.6	1.6	0.50	1.20	0.66	1.28	0.622
	136.525	41.275	41.275	31.750	3.6	3.2	241	308	2 900	3 800	H414249	H414210	30.3	89.0	83.3	121.0	129.0	3.6	3.2	0.36	1.67	0.92	1.80	0.788
	136.525	46.038	46.038	36.512	3.6	3.2	231	369	2 800	3 700	H715345	H715311	37.0	93.0	87.0	118.0	132.0	3.6	3.2	0.47	1.27	0.70	2.15	0.950
73.025	112.712	25.400	25.400	19.050	3.6	3.2	97.0	155	3 200	4 300	29685	29620	26.2	86.0	80.0	101.0	109.0	3.6	3.2	0.49	1.23	0.68	0.602	0.270
	117.475	30.162	30.162	23.812	3.6	3.2	118	179	3 200	4 200	33287	33462	27.8	87.0	80.0	104.0	112.0	3.6	3.2	0.44	1.38	0.76	0.747	0.436
	127.000	36.512	36.170	28.575	3.6	3.2	156	226	3 000	4 000	567	563	28.6	88.0	81.0	112.0	120.0	3.6	3.2	0.36	1.65	0.91	1.14	0.648
	139.992	36.512	36.098	28.575	3.6	3.2	175	262	2 700	3 600	576R	572	31.0	90.0	83.0	125.0	133.0	3.6	3.2	0.40	1.49	0.82	1.74	0.779

[Note] 1) To the bearings with supplementary code "J" attached at the front of bearing number, tolerances shown in table 7-8 on page A66 are applied.

[Remark] Inch series tapered roller bearings with bore diameter larger than 100 mm are shown in catalog "large size ball & roller bearings".

Single-row tapered roller bearings inch series

d (73.025) ~ 76.200 mm

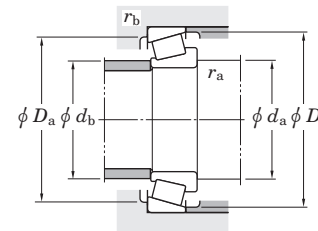
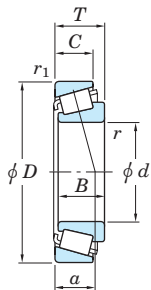

Boundary dimensions (mm)							Basic load ratings (kN)		Limiting speeds (min ⁻¹)		Bearing No. ¹⁾	Load center (mm) a	Mounting dimensions (mm)						Con-stant e	Axial load factors		(Refer.) Mass (kg)				
d	D	T	B	C	$r_{min.}$	$r_{1 min.}$	C_r	C_{0r}	Grease lub.	Oil lub.			Inner ring	Outer ring	d_a	d_b	D_a	D_b		$r_{a max.}$	$r_{b max.}$	Y_1	Y_0	Inner ring	Outer ring	
73.025	146.050	41.275	41.275	31.750	3.6	3.2	208	301	2 600	3 400	657	653	33.4	90.0	85.0	131.0	139.0	3.6	3.2	0.41	1.47	0.81	2.28	0.880		
	149.225	53.975	54.229	44.450	3.6	3.2	285	404	2 700	3 500			6460	6420	39.3	93.0	87.0	129.0	141.0	3.6	3.2	0.36	1.66	0.91	2.79	1.61
	150.089	44.450	46.672	36.512	3.6	3.2	264	368	2 500	3 400			744R	742	32.4	91.0	85.0	134.0	142.0	3.6	3.2	0.33	1.84	1.01	2.66	1.07
	161.925	47.625	48.260	38.100	3.6	3.2	273	391	2 400	3 200			762	752	35.5	92.0	97.0	144.0	150.0	3.6	3.2	0.34	1.76	0.97	3.18	1.61
73.817	112.712	25.400	25.400	19.050	1.6	3.2	97.0	155	3 200	4 300	29688	29620	26.2	83.0	81.0	101.0	109.0	1.6	3.2	0.49	1.23	0.68	0.588	0.270		
	127.000	36.512	36.170	28.575	0.8	3.2	156	226	3 000	4 000			568	563	28.6	83.0	82.0	112.0	120.0	0.8	3.2	0.36	1.65	0.91	1.12	0.648
74.612	139.992	36.512	36.098	28.575	3.6	3.2	175	262	2 700	3 600	577R	572	31.0	91.0	85.0	125.0	133.0	3.6	3.2	0.40	1.49	0.82	1.69	0.779		
75.000	115.000	25.000	25.000	19.000	3.0	2.8	101	151	3 100	4 200	JLM714149	JLM714110	25.5	87.0	81.0	104.0	110.0	3.0	2.8	0.46	1.31	0.72	0.612	0.269		
	120.000	31.000	29.500	25.000	3.0	2.8	145	216	3 100	4 100			JM714249	JM714210	30.0	88.0	82.9	108.0	115.0	3.0	2.8	0.44	1.35	0.74	0.846	0.430
	145.000	51.000	51.000	42.000	3.0	2.5	290	412	2 700	3 600			JH415647	JH415610	36.6	94.0	89.0	129.0	139.0	3.0	2.5	0.36	1.66	0.91	2.66	1.18
76.200	121.442	24.608	23.012	17.462	3.6	2.0	90.0	127	3 000	4 000	34301	34478	26.8	89.0	83.0	110.0	116.0	3.6	2.0	0.45	1.33	0.73	0.617	0.313		
	127.000	30.162	31.000	22.225	3.6	3.2	143	225	2 400	3 200			42687	42620	27.1	90.0	84.0	114.0	121.0	3.6	3.2	0.42	1.43	0.79	1.05	0.434
	127.000	30.162	31.000	22.225	6.4	3.2	143	225	2 400	3 200			42688	42620	27.1	96.0	84.0	114.0	121.0	6.4	3.2	0.42	1.43	0.79	1.04	0.434
	133.350	30.162	29.769	22.225	6.4	3.2	133	198	2 700	3 600			495AX	492A	29.8	98.0	86.0	120.0	128.0	6.4	3.2	0.44	1.35	0.74	1.20	0.430
	133.350	33.338	33.338	26.195	6.4	3.2	154	245	2 700	3 700			47678R	47620	29.2	97.0	90.0	119.0	128.0	6.4	3.2	0.40	1.48	0.82	1.29	0.577
	133.350	33.338	33.338	26.195	0.8	3.2	154	245	2 700	3 700			47680R	47620	29.2	86.0	85.0	119.0	128.0	0.8	3.2	0.40	1.48	0.82	1.39	0.577
	135.733	44.450	46.101	34.925	3.6	3.2	213	337	2 800	3 700			5760	5735	33.0	94.0	88.0	119.0	130.0	3.6	3.2	0.41	1.48	0.81	1.85	0.877
	136.525	30.162	29.769	22.225	3.6	3.2	133	198	2 700	3 600			495A	493	29.8	92.0	86.0	122.0	130.0	3.6	3.2	0.44	1.35	0.74	1.26	0.544
	139.992	36.512	36.098	28.575	3.6	3.2	175	262	2 700	3 600			575R	572	31.0	92.0	86.0	125.0	133.0	3.6	3.2	0.40	1.49	0.82	1.64	0.779
	139.992	36.512	36.098	28.575	6.7	3.2	175	262	2 700	3 600			575SR	572	31.0	99.0	86.0	125.0	133.0	6.7	3.2	0.40	1.49	0.82	1.61	0.779
	149.225	53.975	54.229	44.450	3.6	3.2	285	404	2 700	3 500			6461	6420	39.3	96.0	89.5	129.0	141.0	3.6	3.2	0.36	1.66	0.91	2.64	1.61
	149.225	53.975	54.229	44.450	9.5	3.2	285	404	2 700	3 500			6461A	6420	39.3	105.0	90.0	129.0	141.0	9.5	3.2	0.36	1.66	0.91	2.60	1.61
	150.089	44.450	46.672	36.512	3.6	3.2	264	368	2 500	3 400			748SR	742	32.4	93.0	87.0	134.0	142.0	3.6	3.2	0.33	1.84	1.01	2.51	1.06
	152.400	41.275	41.275	31.750	3.6	3.2	208	301	2 600	3 400			659	652	33.4	93.0	87.0	134.0	141.0	3.6	3.2	0.41	1.47	0.81	2.16	1.25
	190.500	57.150	57.531	46.038	3.6	3.2	440	602	2 000	2 700			HH221430	HH221410	42.5	101.0	95.0	171.0	179.0	3.6	3.2	0.33	1.79	0.99	6.33	2.21

[Note] 1) To the bearings with supplementary code "J" attached at the front of bearing number, tolerances shown in table 7-8 on page A66 are applied.

[Remark] Inch series tapered roller bearings with bore diameter larger than 100 mm are shown in catalog "large size ball & roller bearings".

Single-row tapered roller bearings
inch series

d 77.788 ~ (83.345) mm

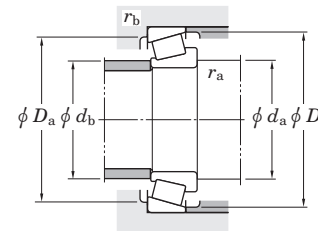
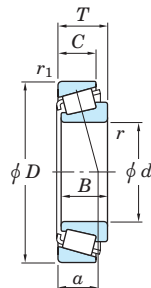

Boundary dimensions (mm)							Basic load ratings (kN)		Limiting speeds (min ⁻¹)		Bearing No. ¹⁾	Load center (mm) a	Mounting dimensions (mm)						Constant e	Axial load factors		(Refer.) Mass (kg)				
d	D	T	B	C	$r_{min.}$	$r_{1 min.}$	C_r	C_{0r}	Grease lub.	Oil lub.			Inner ring	Outer ring	d_a	d_b	D_a	D_b		$r_{a max.}$	$r_{b max.}$	Y_1	Y_0	Inner ring	Outer ring	
77.788	117.475	25.400	25.400	19.050	3.6	3.2	101	166	3 100	4 100	LM814849	LM814810	27.6	91.0	85.0	105.0	113.0	3.6	3.2	0.51	1.18	0.65	0.619	0.295		
	121.442	24.608	23.012	17.462	3.6	2.0	90.0	127	3 000	4 000			34306	34478	26.8	90.0	84.0	110.0	116.0	3.6	2.0	0.45	1.33	0.73	0.583	0.313
	121.442	24.608	23.012	17.462	6.4	2.0	90.0	127	3 000	4 000			34307	34478	26.8	96.0	84.0	110.0	116.0	6.4	2.0	0.45	1.33	0.73	0.571	0.313
	127.000	30.162	31.000	22.225	3.6	3.2	143	225	2 400	3 200			42690	42620	27.1	91.0	85.0	114.0	121.0	3.6	3.2	0.42	1.43	0.79	1.00	0.434
79.375	146.050	41.275	41.275	31.750	3.6	3.2	208	301	2 600	3 400	661	653	33.4	96.0	90.0	131.0	139.0	3.6	3.2	0.41	1.47	0.81	2.04	0.880		
	161.925	47.625	48.260	38.100	7.9	3.2	273	391	2 400	3 200			756A	752	35.5	106.0	91.0	144.0	150.0	7.9	3.2	0.34	1.76	0.97	2.95	1.59
	190.500	57.150	57.531	46.038	3.6	3.2	440	602	2 000	2 700			HH221431	HH221410	42.5	103.0	97.0	171.0	179.0	3.6	3.2	0.33	1.79	0.99	6.16	2.21
80.000	130.000	35.000	34.000	28.500	3.2	2.5	168	256	2 800	3 800	JM515649	JM515610	29.6	94.0	88.0	117.0	125.0	3.2	2.5	0.39	1.54	0.85	1.19	0.575		
	200.000	52.761	49.212	34.925	3.6	3.2	347	471	1 400	1 900			98316	98788	54.5	111.0	105.0	174.0	188.0	3.6	3.2	0.63	0.95	0.52	5.73	2.28
80.962	133.350	30.162	29.769	22.225	3.6	3.2	133	198	2 700	3 600	496	492A	29.8	95.0	89.0	120.0	128.0	3.6	3.2	0.44	1.35	0.74	1.12	0.429		
	133.350	33.338	33.338	26.195	3.6	3.2	154	245	2 700	3 700			47681R	47620	29.2	95.0	89.0	119.0	128.0	3.6	3.2	0.40	1.48	0.82	1.17	0.577
	139.992	36.512	36.098	28.575	3.6	3.2	175	262	2 700	3 600			581R	572	31.0	96.0	90.0	125.0	133.0	3.6	3.2	0.40	1.49	0.82	1.47	0.779
	150.089	44.450	46.672	36.512	5.2	3.2	264	368	2 500	3 400			740R	742	32.4	101.0	91.0	134.0	142.0	5.2	3.2	0.33	1.84	1.01	2.30	1.06
82.550	125.412	25.400	25.400	19.845	3.6	1.6	101	162	2 900	3 800	27687	27620	24.7	96.0	89.0	115.0	120.0	3.6	1.6	0.42	1.44	0.79	0.710	0.344		
	133.350	30.162	29.769	22.225	3.6	3.2	133	198	2 700	3 600			495	492A	29.8	97.0	90.0	120.0	128.0	3.6	3.2	0.44	1.35	0.74	1.08	0.429
	133.350	33.338	33.338	26.195	3.6	0.8	154	245	2 700	3 700			47686R	47620A	29.2	97.0	90.0	121.0	128.0	3.6	0.8	0.40	1.48	0.82	1.13	0.577
	133.350	39.688	39.688	32.545	6.7	3.2	177	306	2 800	3 700			HM516448	HM516410	32.2	105.0	92.0	118.0	128.0	6.7	3.2	0.40	1.49	0.82	1.33	0.763
	139.700	36.512	36.098	28.575	3.6	3.2	175	262	2 700	3 600			580R	572X	31.0	98.0	91.0	125.0	133.0	3.6	3.2	0.40	1.49	0.82	1.41	0.765
	139.992	36.512	36.098	28.575	3.6	3.2	175	262	2 700	3 600			580R	572	31.0	98.0	91.0	125.0	133.0	3.6	3.2	0.40	1.49	0.82	1.41	0.779
	139.992	36.512	36.098	28.575	6.7	3.2	175	262	2 700	3 600			582R	572	31.0	104.0	91.0	125.0	133.0	6.7	3.2	0.40	1.49	0.82	1.40	0.779
	146.050	41.275	41.275	31.750	3.6	3.2	208	301	2 600	3 400			663	653	33.4	99.0	92.0	131.0	139.0	3.6	3.2	0.41	1.47	0.81	1.91	0.880
	150.089	44.450	46.672	36.512	3.6	3.2	264	368	2 500	3 400			749AR	742	32.4	99.0	93.0	134.0	142.0	3.6	3.2	0.33	1.84	1.01	2.23	1.06
	150.089	44.450	46.672	36.512	6.7	3.2	264	368	2 500	3 400			750AR	742	32.4	106.0	93.0	134.0	142.0	6.7	3.2	0.33	1.84	1.01	2.19	1.06
	161.925	47.625	48.260	38.100	3.6	3.2	273	391	2 400	3 200			757	752	35.5	100.0	94.0	144.0	150.0	3.6	3.2	0.34	1.76	0.97	2.83	1.59
	83.345	125.412	25.400	25.400	19.845	0.8	1.6	101	162	2 900			3 800	27689	27620	24.7	90.0	90.0	115.0	120.0	0.8	1.6	0.42	1.44	0.79	0.746

[Note] 1) To the bearings with supplementary code "J" attached at the front of bearing number, tolerances shown in table 7-8 on page A66 are applied.

[Remark] Inch series tapered roller bearings with bore diameter larger than 100 mm are shown in catalog "large size ball & roller bearings".

Single-row tapered roller bearings
inch series

d (83.345) ~ (88.900) mm

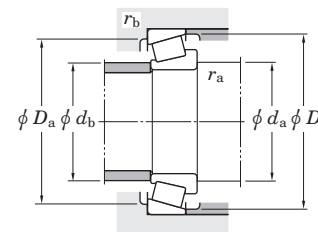
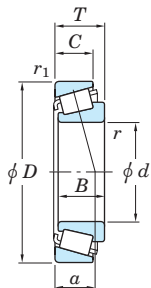

Boundary dimensions (mm)							Basic load ratings (kN)		Limiting speeds (min ⁻¹)		Bearing No. ¹⁾	Load center (mm) a	Mounting dimensions (mm)					Con-stant e	Axial load factors		(Refer.) Mass (kg)			
d	D	T	B	C	r min.	r_1 min.	C_r	C_{0r}	Grease lub.	Oil lub.			Inner ring	Outer ring	d_a	d_b	D_a		D_b	r_a max.	r_b max.	Y_1	Y_0	Inner ring
83.345	125.412	25.400	25.400	19.845	3.6	1.6	101	162	2 900	3 800	27690	27620	24.7	96.0	90.0	115.0	120.0	3.6	1.6	0.42	1.44	0.79	0.689	0.344
	125.412	25.400	25.400	19.845	6.4	1.6	101	162	2 900	3 800			24.7	102.0	90.0	115.0	120.0	6.4	1.6	0.42	1.44	0.79	0.646	0.344
84.138	133.350	30.162	29.769	22.225	3.6	3.2	133	198	2 700	3 600	498	492A	29.8	98.0	91.0	120.0	128.0	3.6	3.2	0.44	1.35	0.74	1.04	0.429
85.000	130.000	30.000	29.000	24.000	3.0	2.5	142	228	2 800	3 700	JM716649	JM716610	29.1	98.0	92.0	117.0	125.0	3.0	2.5	0.44	1.35	0.74	0.937	0.456
	140.000	39.000	38.000	31.500	3.0	2.5	203	308	2 700	3 500			32.8	100.0	93.9	125.0	134.0	3.0	2.5	0.41	1.47	0.81	1.54	0.759
	150.000	46.000	46.000	38.000	3.0	2.5	274	390	2 500	3 400			33.6	101.0	95.2	134.0	142.0	3.0	2.5	0.33	1.80	0.99	2.28	1.08
	200.000	52.761	49.212	34.925	3.6	3.2	347	471	1 400	1 900			54.5	115.0	109.0	174.0	188.0	3.6	3.2	0.63	0.95	0.52	5.47	2.28
85.026	150.089	44.450	46.672	36.512	3.6	3.2	264	368	2 500	3 400	749R	742	32.4	101.0	95.0	134.0	142.0	3.6	3.2	0.33	1.84	1.01	2.12	1.06
	150.089	44.450	46.672	36.512	5.2	3.2	264	368	2 500	3 400			32.4	104.0	95.0	134.0	142.0	5.2	3.2	0.33	1.84	1.01	2.08	1.06
85.725	133.350	30.162	29.769	22.225	3.6	3.2	133	198	2 700	3 600	497	492A	29.8	99.0	93.0	120.0	128.0	3.6	3.2	0.44	1.35	0.74	0.978	0.429
	136.525	30.162	29.769	22.225	6.4	3.2	133	198	2 700	3 600			29.8	105.0	93.0	122.0	130.0	6.4	3.2	0.44	1.35	0.74	0.965	0.544
	142.138	42.862	42.862	34.133	4.8	3.2	219	351	2 600	3 500			35.2	106.0	95.7	125.0	137.0	4.8	3.2	0.43	1.39	0.76	1.72	0.902
	146.050	41.275	41.275	31.750	3.6	3.2	208	301	2 600	3 400			33.4	102.0	95.0	131.0	139.0	3.6	3.2	0.41	1.47	0.81	1.77	0.880
	146.050	41.275	41.275	31.750	6.4	3.2	208	301	2 600	3 400			33.4	107.0	95.0	131.0	139.0	6.4	3.2	0.41	1.47	0.81	1.76	0.880
	152.400	39.688	36.322	30.162	3.6	3.2	183	287	2 400	3 300			37.1	102.0	96.0	135.0	144.0	3.6	3.2	0.44	1.36	0.75	1.83	1.04
	161.925	47.625	48.260	38.100	3.6	3.2	273	391	2 400	3 200			35.5	103.0	97.0	144.0	150.0	3.6	3.2	0.34	1.76	0.97	2.67	1.59
	168.275	41.275	41.275	30.162	3.6	3.2	224	349	2 200	3 000			38.6	105.0	99.0	149.0	160.0	3.6	3.2	0.47	1.28	0.70	2.89	1.22
	168.275	53.975	56.363	41.275	3.6	3.2	344	467	2 300	3 100			35.0	104.0	97.0	149.0	155.0	3.6	3.2	0.30	2.00	1.10	3.47	1.72
	88.900	123.825	20.638	20.638	16.670	1.6	1.6	81.8	145	2 800			3 700	L217849	L217810	20.7	97.0	94.0	116.0	119.0	1.6	1.6	0.33	1.82
152.400		39.688	39.688	30.162	6.4	3.2	248	359	2 400	3 200	33.1	110.0	98.0			135.0	114.0	6.4	3.2	0.40	1.49	0.82	2.10	0.768
161.925		47.625	48.260	38.100	3.6	3.2	273	391	2 400	3 200	35.5	106.0	99.0			144.0	150.0	3.6	3.2	0.34	1.76	0.97	2.50	1.59
161.925		47.625	48.260	38.100	7.1	3.2	273	391	2 400	3 200	35.5	113.0	99.0			144.0	150.0	7.1	3.2	0.34	1.76	0.97	2.48	1.59
161.925		53.975	55.100	42.862	3.6	3.2	316	471	2 400	3 200	49.8	109.0	98.0			141.0	154.0	3.6	3.2	0.40	1.50	0.82	3.09	1.65
168.275		41.275	41.275	30.162	3.6	3.2	224	349	2 200	3 000	38.6	107.0	101.0			149.0	160.0	3.6	3.2	0.47	1.28	0.70	2.75	1.22
190.500		57.150	57.531	44.450	7.9	3.2	385	565	2 100	2 700	40.0	118.0	103.0			170.0	174.0	7.9	3.2	0.33	1.79	0.99	5.05	2.66

[Note] 1) To the bearings with supplementary code "J" attached at the front of bearing number, tolerances shown in table 7-8 on page A66 are applied.

[Remark] Inch series tapered roller bearings with bore diameter larger than 100 mm are shown in catalog "large size ball & roller bearings".

Single-row tapered roller bearings
inch series

d (88.900) ~ 99.975 mm

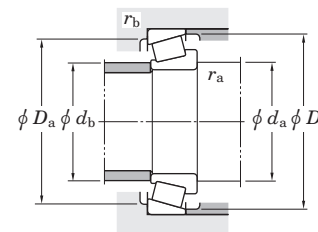
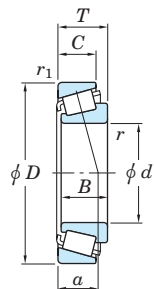

Boundary dimensions (mm)							Basic load ratings (kN)		Limiting speeds (min ⁻¹)		Bearing No. ¹⁾	Load center (mm) <i>a</i>	Mounting dimensions (mm)					Con-stant <i>e</i>	Axial load factors		(Refer.) Mass (kg)			
<i>d</i>	<i>D</i>	<i>T</i>	<i>B</i>	<i>C</i>	<i>r</i> _{min.}	<i>r</i> _{1 min.}	<i>C</i> _r	<i>C</i> _{0r}	Grease lub.	Oil lub.			Inner ring	Outer ring	<i>d</i> _a	<i>d</i> _b	<i>D</i> _a		<i>D</i> _b	<i>r</i> _{a max.}	<i>r</i> _{b max.}	<i>Y</i> ₁	<i>Y</i> ₀	Inner ring
88.900	190.500	57.150	57.531	46.038	7.9	3.2	440	602	2 000	2 700	HH221434	HH221410	42.5	120.0	105.0	171.0	179.0	7.9	3.2	0.33	1.79	0.99	5.57	2.21
	200.000	52.761	49.212	34.925	3.6	3.2	347	471	1 400	1 900			98350	98788	54.5	118.0	112.0	174.0	188.0	3.6	3.2	0.63	0.95	0.52
89.974	146.975	40.000	40.000	32.500	7.1	3.6	206	310	2 500	3 300	HM218248	HM218210	30.8	112.0	99.0	133.0	141.0	7.1	3.6	0.33	1.80	0.99	1.66	0.784
90.000	145.000	35.000	34.000	27.000	3.0	2.5	194	291	2 500	3 400	JM718149	JM718110	32.7	105.0	99.0	131.0	139.0	3.0	2.5	0.44	1.35	0.74	1.47	0.652
	155.000	44.000	44.000	35.500	3.0	2.5	290	407	2 400	3 200	JHM318448	JHM318410	34.5	106.0	100.0	140.0	148.0	3.0	2.5	0.34	1.76	0.97	2.37	1.00
	161.925	53.975	55.100	42.862	3.0	3.2	316	471	2 400	3 200	6581XR	6535	41.0	102.0	98.0	141.0	154.0	3.0	3.2	0.40	1.50	0.82	3.02	1.65
90.488	161.925	47.625	48.260	38.100	3.6	3.2	273	391	2 400	3 200	760	752	35.5	107.0	101.0	144.0	150.0	3.6	3.2	0.34	1.76	0.97	2.42	1.59
92.075	146.050	33.338	34.925	26.195	3.6	3.2	178	293	2 500	3 300	47890R	47820	32.6	107.0	101.0	131.0	140.0	3.6	3.2	0.45	1.34	0.74	1.46	0.657
	168.275	41.275	41.275	30.162	3.6	3.2	224	349	2 200	3 000	681	672	38.6	110.0	104.0	149.0	160.0	3.6	3.2	0.47	1.28	0.70	2.61	1.22
	168.275	41.275	41.275	30.162	6.4	3.2	224	349	2 200	3 000	681A	672	38.6	116.0	104.0	149.0	160.0	6.4	3.2	0.47	1.28	0.70	2.60	1.22
	180.975	47.625	48.006	38.100	3.6	3.2	288	438	2 100	2 800	778	772	39.5	111.0	105.0	161.0	168.0	3.6	3.2	0.39	1.56	0.86	3.65	1.92
	190.500	57.150	57.531	44.450	7.9	3.2	385	565	2 100	2 700	857R	854	39.9	121.0	106.0	170.0	174.0	7.9	3.2	0.33	1.79	0.99	4.86	2.66
95.000	150.000	35.000	34.000	27.000	3.0	2.5	187	294	2 400	3 300	JM719149	JM719113	33.5	109.0	104.0	135.0	143.0	3.0	2.5	0.44	1.36	0.75	1.43	0.766
95.250	128.588	15.875	15.083	11.908	1.6	1.6	58.0	93.0	2 600	3 500	LL319349	LL319310	20.3	103.0	100.0	122.0	124.0	1.6	1.6	0.35	1.71	0.94	0.393	0.147
	130.175	20.638	21.432	16.670	1.6	1.6	97.0	167	2 600	3 500	L319249	L319210	22.2	107.0	101.0	122.0	125.0	1.6	1.6	0.35	1.72	0.95	0.548	0.246
	146.050	33.338	34.925	26.195	3.6	3.2	178	293	2 500	3 300	47896R	47820	32.6	110.0	103.0	131.0	140.0	3.6	3.2	0.45	1.34	0.74	1.34	0.657
	147.638	35.717	36.322	26.192	5.2	0.8	183	287	2 400	3 300	594A	592XE	33.4	113.0	104.0	135.0	142.0	5.2	0.8	0.44	1.36	0.75	1.45	0.620
	157.162	36.512	36.116	26.195	3.6	3.2	180	288	2 300	3 000	52375	52618	36.0	112.0	105.0	142.0	152.0	3.6	3.2	0.47	1.26	0.69	1.94	0.694
	168.275	41.275	41.275	30.162	3.6	3.2	224	349	2 200	3 000	683	672	38.6	113.0	106.0	149.0	160.0	3.6	3.2	0.47	1.28	0.70	2.46	1.22
	190.500	57.150	57.531	44.450	7.9	3.2	385	565	2 100	2 700	864R	854	39.9	123.0	108.0	170.0	174.0	7.9	3.2	0.33	1.79	0.99	4.64	2.66
	190.500	57.150	57.531	46.038	7.9	3.2	440	602	2 000	2 700	HH221440	HH221410	42.5	125.0	110.0	171.0	179.0	7.9	3.2	0.33	1.79	0.99	5.16	2.21
98.425	168.275	41.275	41.275	30.162	3.6	3.2	224	349	2 200	3 000	685	672	38.6	116.0	109.0	149.0	160.0	3.6	3.2	0.47	1.28	0.70	2.29	1.22
	190.500	57.150	57.531	46.038	3.6	3.2	440	602	2 000	2 700	HH221442	HH221410	42.5	119.0	113.0	171.0	179.0	3.6	3.2	0.33	1.79	0.99	4.97	2.21
99.975	212.725	66.675	66.675	53.975	3.6	3.2	513	699	1 800	2 400	HH224334	HH224310	47.6	122.0	117.0	192.0	202.0	3.6	3.2	0.33	1.84	1.01	7.91	3.03

[Note] 1) To the bearings with supplementary code "J" attached at the front of bearing number, tolerances shown in table 7-8 on page A66 are applied.

[Remark] Inch series tapered roller bearings with bore diameter larger than 100 mm are shown in catalog "large size ball & roller bearings".

Single-row tapered roller bearings
inch series

d 99.982 ~ (107.950) mm

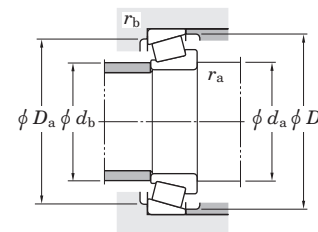
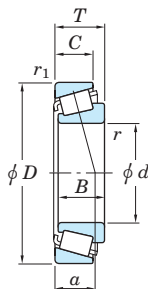

Boundary dimensions (mm)							Basic load ratings (kN)		Limiting speeds (min ⁻¹)		Bearing No. ¹⁾	Load center (mm) <i>a</i>	Mounting dimensions (mm)						Con-stant <i>e</i>	Axial load factors		(Refer.) Mass (kg)		
<i>d</i>	<i>D</i>	<i>T</i>	<i>B</i>	<i>C</i>	<i>r</i> _{min.}	<i>r</i> _{1 min.}	<i>C_r</i>	<i>C_{0r}</i>	Grease lub.	Oil lub.			Inner ring	Outer ring	<i>d_a</i>	<i>d_b</i>	<i>D_a</i>	<i>D_b</i>		<i>r_a</i> _{max.}	<i>r_b</i> _{max.}	<i>Y</i> ₁	<i>Y</i> ₀	Inner ring
99.982	190.500	57.150	57.531	46.038	6.4	3.2	440	602	2 000	2 700	HH221447	HH221410	42.5	126.0	114.0	171.0	179.0	6.4	3.2	0.33	1.79	0.99	4.84	2.21
100.000	155.000	36.000	35.000	28.000	3.0	2.5	204	328	2 300	3 100	JM720249	JM720210	35.6	110.0	110.0	139.0	148.0	3.0	2.5	0.47	1.27	0.70	1.64	0.763
	160.000	41.000	40.000	32.000	3.0	2.5	237	378	2 300	3 000	JHM720249	JHM720210	38.3	110.0	111.0	143.0	153.0	3.0	2.5	0.47	1.28	0.70	2.11	0.964
100.012	157.162	36.512	36.116	26.195	3.6	3.2	180	288	2 300	3 000	52393	52618	36.0	113.0	115.0	142.0	150.0	3.6	3.2	0.47	1.26	0.69	1.74	0.694
101.600	157.162	36.512	36.116	26.195	3.6	3.2	180	288	2 300	3 000	52400	52618	36.0	114.0	115.0	142.0	150.0	3.6	3.2	0.47	1.26	0.69	1.67	0.694
	157.162	36.512	36.116	26.195	7.9	3.2	180	288	2 300	3 000	52401	52618	36.0	126.0	111.0	142.0	152.0	7.9	3.2	0.47	1.26	0.69	1.64	0.694
	168.275	41.275	41.275	30.162	3.6	3.2	224	349	2 200	3 000	687	672	38.6	114.0	115.0	146.0	156.0	3.6	3.2	0.47	1.28	0.70	2.15	1.22
	180.975	47.625	48.006	38.100	3.6	3.2	288	438	2 100	2 800	780	772	39.5	114.0	120.0	156.0	165.0	3.6	3.2	0.39	1.56	0.86	3.09	1.92
	190.500	57.150	57.531	44.450	7.9	3.2	385	565	2 100	2 700	861R	854	39.9	129.0	114.0	170.0	174.0	7.9	3.2	0.33	1.79	0.99	4.20	2.66
	190.500	57.150	57.531	46.038	7.9	3.2	440	602	2 000	2 700	HH221449	HH221410	42.5	123.0	119.0	168.0	178.0	7.9	3.2	0.33	1.79	0.99	4.72	2.21
	200.000	52.761	49.212	34.925	3.6	3.2	347	471	1 400	1 900	98400	98788	54.5	114.0	123.0	170.0	185.0	3.6	3.2	0.63	0.95	0.52	4.55	2.28
	212.725	66.675	66.675	53.975	7.1	3.2	450	674	1 800	2 400	941	932	47.6	121.0	135.0	181.0	192.0	7.1	3.2	0.33	1.84	1.01	7.07	4.07
	212.725	66.675	66.675	53.975	7.1	3.2	513	699	1 800	2 400	HH224335	HH224310	47.6	121.0	134.0	189.0	201.0	7.1	3.2	0.33	1.84	1.01	7.76	3.03
104.775	180.975	47.625	48.006	38.100	3.6	3.2	288	438	2 100	2 800	782	772	39.5	117.0	120.0	156.0	165.0	3.6	3.2	0.39	1.56	0.86	2.90	1.92
	180.975	47.625	48.006	38.100	6.4	3.2	288	438	2 100	2 800	786	772	39.5	123.0	120.0	156.0	165.0	6.4	3.2	0.39	1.56	0.86	2.88	1.92
	180.975	47.625	48.006	38.100	7.1	3.2	288	438	2 100	2 800	787	772	39.5	129.0	116.0	161.0	168.0	7.1	3.2	0.39	1.56	0.86	2.87	1.92
	190.500	47.625	49.212	34.925	3.6	3.2	303	483	1 900	2 600	71412	71750	40.9	117.0	131.0	167.0	177.0	3.6	3.2	0.42	1.44	0.79	3.96	1.72
106.362	165.100	36.512	36.512	26.988	3.6	3.2	195	325	2 200	2 900	56418R	56650	38.6	122.0	116.0	149.0	159.0	3.6	3.2	0.50	1.21	0.66	1.84	0.852
107.950	146.050	21.432	21.432	16.670	1.6	1.6	86.4	167	2 300	3 100	L521949R	L521910	26.2	116.0	114.0	136.0	141.0	1.6	1.6	0.39	1.53	0.84	0.665	0.325
	158.750	23.020	21.438	15.875	3.6	3.2	104	169	2 200	3 000	37425	37625	36.5	121.0	121.0	141.0	148.0	3.6	3.2	0.61	0.99	0.54	0.893	0.484
	159.987	34.925	34.925	26.988	3.6	3.2	184	319	2 200	2 900	LM522546	LM522510	32.9	122.0	116.0	146.0	154.0	3.6	3.2	0.40	1.50	0.82	1.64	0.784
	161.925	34.925	34.925	26.988	3.6	3.2	173	293	2 200	2 900	48190	48120	39.1	121.0	120.0	145.0	154.0	3.6	3.2	0.51	1.19	0.65	1.57	0.820
	165.100	36.512	36.512	26.988	3.6	3.2	195	325	2 200	2 900	56425R	56650	38.6	123.0	117.0	149.0	159.0	3.6	3.2	0.50	1.21	0.66	1.76	0.852
	168.275	36.512	36.512	26.988	3.6	3.2	195	325	2 200	2 900	56425R	56662	38.6	123.0	117.0	150.0	160.0	3.6	3.2	0.50	1.21	0.66	1.76	1.03
	190.500	47.625	49.212	34.925	3.6	3.2	303	483	1 900	2 600	71425	71750	40.9	121.0	131.0	167.0	177.0	3.6	3.2	0.42	1.44	0.79	3.76	1.72

[Note] 1) To the bearings with supplementary code "J" attached at the front of bearing number, tolerances shown in table 7-8 on page A66 are applied.

[Remark] Inch series tapered roller bearings with bore diameter larger than 100 mm are shown in catalog "large size ball & roller bearings".

Single-row tapered roller bearings
inch series

d (107.950) ~ 127.000 mm

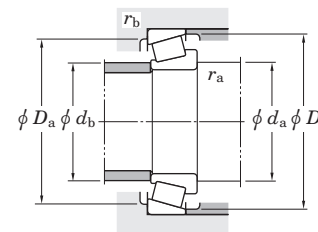
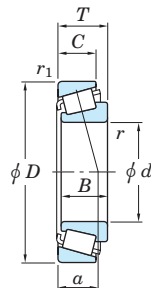

Boundary dimensions (mm)							Basic load ratings (kN)		Limiting speeds (min ⁻¹)		Bearing No. ¹⁾	Load center (mm) a	Mounting dimensions (mm)						Con-stant e	Axial load factors		(Refer.) Mass (kg)				
d	D	T	B	C	$r_{min.}$	$r_{1min.}$	C_r	C_{0r}	Grease lub.	Oil lub.			Inner ring	Outer ring	d_a	d_b	D_a	D_b		$r_{a max.}$	$r_{b max.}$	Y_1	Y_0	Inner ring	Outer ring	
107.950	212.725	66.675	66.675	53.975	7.9	3.2	450	674	1 800	2 400	936	932	47.6	137.0	122.0	187.0	193.0	7.9	3.2	0.33	1.84	1.01	6.52	4.07		
	212.725	66.675	66.675	53.975	7.9	3.2	513	699	1 800	2 400			HH224340	HH224310	47.6	129.0	134.0	189.0	201.0	7.9	3.2	0.33	1.84	1.01	7.21	3.03
109.538	158.750	23.020	21.438	15.875	6.4	6.4	104	169	2 200	3 000	37431	37625	36.5	123.0	116.0	143.0	152.0	6.4	6.4	0.61	0.99	0.54	0.848	0.484		
109.987	159.987	34.925	34.925	26.988	7.9	3.2	184	319	2 200	2 900	LM522548	LM522510	32.9	131.0	121.0	146.0	153.0	7.9	3.2	0.40	1.50	0.82	1.52	0.784		
	159.987	34.925	34.925	26.988	3.6	3.2	184	319	2 200	2 900			LM522549	LM522510	32.9	123.0	121.0	146.0	153.0	3.6	3.2	0.40	1.50	0.82	1.55	0.784
109.992	177.800	41.275	41.275	30.162	3.6	3.2	234	380	2 000	2 700	64433R	64700	42.8	128.0	121.0	160.0	172.6	3.6	3.2	0.52	1.16	0.64	2.69	1.10		
110.000	165.000	35.000	35.000	26.500	3.0	2.5	195	325	2 200	2 900	JM822049	JM822010	38.1	121.0	121.0	148.0	157.0	3.0	2.5	0.50	1.21	0.66	1.64	0.826		
	180.000	47.000	46.000	38.000	3.0	2.5	306	487	2 000	2 700			JHM522649	JHM522610	40.6	121.0	125.0	160.0	171.0	3.0	2.5	0.41	1.48	0.81	3.08	1.49
114.300	177.800	41.275	41.275	30.162	3.6	3.2	234	380	2 000	2 700	64450R	64700	42.8	131.0	125.0	160.0	172.0	3.6	3.2	0.52	1.16	0.64	2.45	1.10		
	180.975	34.925	31.750	25.400	3.6	3.2	171	247	2 000	2 700			68450	68712	40.6	127.0	131.0	161.0	169.0	3.6	3.2	0.50	1.21	0.66	1.89	1.04
	190.500	47.625	49.212	34.925	3.6	3.2	303	483	1 900	2 600			71450	71750	40.9	127.0	131.0	167.0	177.0	3.6	3.2	0.42	1.44	0.79	3.33	1.72
	212.725	66.675	66.675	53.975	7.1	3.2	450	674	1 800	2 400			938	932	47.6	141.0	128.0	187.0	193.0	7.1	3.2	0.33	1.84	1.01	5.96	4.07
	212.725	66.675	66.675	53.975	7.1	3.2	513	699	1 800	2 400			HH224346	HH224310	47.6	134.0	134.0	189.0	201.0	7.1	3.2	0.33	1.84	1.01	6.64	3.03
	273.050	82.550	82.550	53.975	6.4	6.4	707	898	1 500	1 900			HH926744	HH926710	76.1	133.0	151.0	230.0	252.0	6.4	6.4	0.63	0.95	0.52	15.0	6.97
	273.050	82.550	82.550	53.975	6.4	6.4	707	898	1 500	1 900			HH926744	HH926710	76.1	133.0	151.0	230.0	252.0	6.4	6.4	0.63	0.95	0.52	15.0	6.97
114.976	212.725	66.675	66.675	53.975	7.1	3.2	513	699	1 800	2 400	HH224349	HH224310	47.6	135.0	134.0	189.0	201.0	7.1	3.2	0.33	1.84	1.01	6.58	3.03		
115.087	190.500	47.625	49.212	34.925	3.6	3.2	303	483	1 900	2 600	71453	71750	40.9	133.0	126.0	171.0	181.0	3.6	3.2	0.42	1.44	0.79	3.28	1.72		
	190.500	47.625	49.212	34.925	7.9	3.2	303	483	1 900	2 600			71455	71750	40.9	136.0	131.0	167.0	177.0	7.9	3.2	0.42	1.44	0.79	3.25	1.72
117.475	180.975	34.925	31.750	25.400	3.6	3.2	171	247	2 000	2 700	68462	68712	40.6	130.0	131.0	161.0	169.0	3.6	3.2	0.50	1.21	0.66	1.75	1.04		
	180.975	34.925	31.750	25.400	7.9	3.2	171	247	2 000	2 700			68463	68712	40.6	141.0	125.0	163.0	172.0	7.9	3.2	0.50	1.21	0.66	1.61	1.05
120.650	190.500	46.038	46.038	34.925	3.6	1.6	313	512	1 900	2 500	HM624749	HM624710	41.6	146.0	132.0	174.0	184.0	3.6	1.6	0.43	1.41	0.77	3.20	1.44		
	254.000	77.788	82.550	61.912	9.5	6.4	717	1 050	1 500	2 000			HH228340	HH228310	54.3	158.0	142.0	223.0	234.0	9.5	6.4	0.32	1.87	1.03	12.6	6.00
127.000	254.000	77.788	82.550	61.912	9.5	6.4	717	1 050	1 500	2 000	HH228349	HH228310	54.3	164.0	148.0	223.0	234.0	9.5	6.4	0.32	1.87	1.03	11.8	6.00		

[Note] 1) To the bearings with supplementary code "J" attached at the front of bearing number, tolerances shown in table 7-8 on page A66 are applied.

[Remark] Inch series tapered roller bearings with bore diameter larger than 100 mm are shown in catalog "large size ball & roller bearings".

Single-row tapered roller bearings
inch series

d 133.350 ~ 292.100 mm

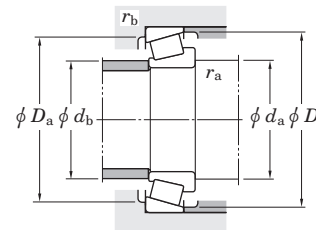
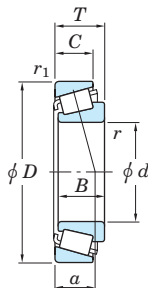

Boundary dimensions (mm)							Basic load ratings (kN)		Limiting speeds (min ⁻¹)		Bearing No. ¹⁾	Load center (mm) a	Mounting dimensions (mm)						Con-stant e	Axial load factors		(Refer.) Mass (kg)		
d	D	T	B	C	r _{min.}	r _{1 min.}	C _r	C _{0r}	Grease lub.	Oil lub.			Inner ring	Outer ring	d _a	d _b	D _a	D _b		r _{a max.}	r _{b max.}	Y ₁	Y ₀	Inner ring
133.350	177.008	25.400	26.195	20.638	1.6	1.6	141	278	1 900	2 500	L327249	L327210	29.1	142.0	145.0	164.0	169.0	1.6	1.6	0.35	1.72	0.95	1.14	0.543
142.875	200.025	41.275	39.688	34.130	7.9	3.3	246	491	1 700	2 200	48684	48620	38.4	166.0	151.0	185.0	193.0	7.9	3.3	0.34	1.78	0.98	2.43	1.38
	200.025	41.275	39.688	34.130	3.6	3.3	246	491	1 700	2 200	48685	48620	38.4	156.0	157.0	182.0	190.0	3.6	3.3	0.34	1.78	0.98	2.46	1.38
170.000	230.000	39.000	38.000	31.000	3.0	2.5	291	558	1 400	1 900	JHM534149	JHM534110	43.6	181.0	184.0	214.0	222.0	3.0	2.5	0.38	1.57	0.86	3.17	1.29
	240.000	46.000	44.500	37.000	3.0	2.5	353	666	1 400	1 800	JM734449	JM734410	50.6	181.0	184.0	220.0	231.0	3.0	2.5	0.44	1.37	0.75	4.31	2.00
171.450	222.250	25.400	24.608	19.050	1.6	1.6	157	299	1 400	1 900	L435049	L435010	36.0	181.0	179.0	211.0	215.0	1.6	1.6	0.38	1.60	0.88	1.63	0.697
180.000	250.000	47.000	45.000	37.000	3.0	2.5	365	705	1 300	1 700	JM736149	JM736110	55.2	191.0	193.0	230.0	242.0	3.0	2.5	0.48	1.25	0.69	4.47	2.10
190.000	260.000	46.000	44.000	36.500	3.0	2.5	369	723	1 200	1 700	JM738249	JM738210	56.0	201.0	203.0	240.0	251.0	3.0	2.5	0.48	1.26	0.69	4.71	2.18
196.850	254.000	28.575	27.783	21.433	1.6	1.6	188	387	1 200	1 600	L540049	L540010	43.1	206.0	214.0	238.0	243.0	1.6	1.6	0.40	1.51	0.83	2.34	1.02
200.000	300.000	65.000	62.000	51.000	3.6	2.5	617	1 140	1 100	1 500	JHM840449	JHM840410	72.1	213.0	218.0	270.0	288.0	3.6	2.5	0.52	1.15	0.63	9.97	5.13
220.878	317.500	47.625	52.388	36.513	3.2	3.2	488	928	970	1 300	LM245833	LM245810	50.5	234.0	253.0	296.0	304.0	3.2	3.2	0.33	1.80	0.99	9.56	2.78
228.600	358.775	71.438	71.438	53.975	3.6	3.2	773	1 590	840	1 100	M249732	M249710	64.4	242.0	279.0	330.0	342.0	3.6	3.2	0.33	1.80	0.99	20.1	6.44
230.188	317.500	47.625	52.388	36.513	3.2	3.2	488	928	970	1 300	LM245846	LM245810	50.5	242.0	238.0	309.0	312.0	3.2	3.2	0.33	1.80	0.99	8.25	2.78
231.775	317.500	47.625	52.388	36.513	3.2	3.2	488	928	970	1 300	LM245848	LM245810	50.5	244.0	240.0	309.0	312.0	3.2	3.2	0.33	1.80	0.99	8.02	2.78
	336.550	65.088	65.088	50.800	6.4	3.2	708	1 380	920	1 200	M246942	M246910	59.9	258.0	249.0	313.0	322.0	6.4	3.2	0.33	1.80	0.99	13.1	5.44
	358.775	71.438	71.438	53.975	6.4	3.2	773	1 590	920	1 200	M249734	M249710	64.4	258.0	253.0	335.0	343.0	6.4	3.2	0.33	1.80	0.99	19.9	6.44
254.000	358.775	71.438	71.438	53.975	3.6	3.2	773	1 590	840	1 100	M249749	M249710	64.4	268.0	279.0	330.0	342.0	3.6	3.2	0.33	1.80	0.99	14.8	6.44
257.175	342.900	57.150	57.150	44.450	6.4	3.2	612	1 280	870	1 200	M349549	M349510	60.1	276.0	276.0	320.0	330.0	6.4	3.2	0.35	1.73	0.95	9.27	3.99
292.100	374.650	47.625	47.625	34.925	3.6	3.2	468	971	760	1 000	L555249	L555210	64.7	306.0	309.0	351.0	360.0	3.6	3.2	0.40	1.49	0.82	7.97	3.53

[Note] 1) To the bearings with supplementary code "J" attached at the front of bearing number, tolerances shown in table 7-8 on page A66 are applied.

[Remark] Inch series tapered roller bearings with bore diameter larger than 100 mm are shown in catalog "large size ball & roller bearings".

Double-row tapered roller bearings

TDO type

d 25 ~ (60) mm

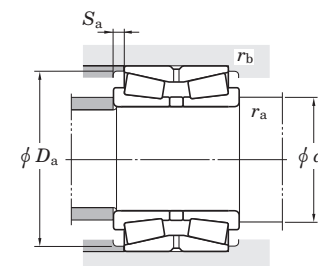
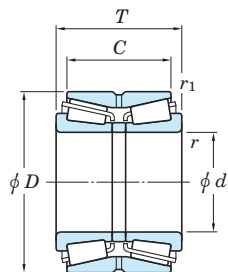

Boundary dimensions (mm)						Basic load ratings (kN)		Limiting speeds (min ⁻¹)		Bearings No.	Mounting dimensions (mm)					Constant e	Axial load factors			(Refer.) Mass (kg)
d	D	T	C	$r_{min.}$	$r_{1 min.}$	C_r	C_{0r}	Grease lub.	Oil lub.		d_a min.	D_a min.	S_a min.	r_a max.	r_b max.		Y_2	Y_3	Y_0	
25	62	40	29.5	1.5	0.6	68.3	84.9	4 500	6 400	46T30305DJR/29.5	33.5	58.5	5	1.5	0.6	0.83	0.82	1.22	0.8	0.592
30	72	45	31.5	1.5	0.6	87.3	110	3 900	5 400	46T30306DJR/31.5	38.5	68	6.5	1.5	0.6	0.83	0.82	1.22	0.8	0.872
35	80	51	35.5	2	0.6	108	138	3 400	4 800	46T30307DJR/35.5	45	76.5	7.5	2	0.6	0.83	0.82	1.22	0.8	1.2
40	80	45	37.5	1.5	0.6	108	138	4 000	5 300	46T30208JR/37.5	48.5	75	3.5	1.5	0.6	0.37	1.8	2.68	1.76	0.954
	80	55	43.5	1.5	0.6	133	182	4 000	5 300	46T32208JR/43.5	48.5	75	5.5	1.5	0.6	0.37	1.8	2.68	1.76	1.19
	90	56	39.5	2	0.6	138	180	3 000	4 200	46T30308DJR/39.5	50	86.5	8	2	0.6	0.83	0.82	1.22	0.8	1.67
	90	56	45.5	2	0.6	155	202	3 600	4 900	46T30308JR/45.5	50	82	5	2	0.6	0.35	1.96	2.91	1.91	1.67
45	85	47	37.5	1.5	0.6	115	155	3 700	4 900	46T30209JR/37.5	53.5	80	4.5	1.5	0.6	0.4	1.67	2.48	1.63	1.1
	85	55	43.5	1.5	0.6	144	207	3 700	4 900	46T32209JR-1/43.5	53.5	81	5.5	1.5	0.6	0.4	1.67	2.48	1.63	1.31
	100	60	41.5	2	0.6	163	214	2 700	3 800	46T30309DJR/41.5	55	96	9	2	0.6	0.83	0.82	1.22	0.8	2.15
	100	60	49.5	2	0.6	193	256	3 300	4 300	46T30309JR/49.5	55	93	5	2	0.6	0.35	1.96	2.91	1.91	2.2
50	90	49	39.5	1.5	0.6	131	183	3 400	4 600	46T30210JR/39.5	58.5	85	4.5	1.5	0.6	0.42	1.61	2.39	1.57	1.22
	90	55	43.5	1.5	0.6	146	211	3 500	4 600	46T32210JR/43.5	58.5	85	5.5	1.5	0.6	0.42	1.61	2.39	1.57	1.39
	110	64	51.5	2	0.6	236	305	3 000	4 000	46T30310JR/51.5	62	102	6	2	0.6	0.35	1.96	2.91	1.91	2.68
	110	73	52.5	2	0.6	198	266	2 500	3 500	46T30310DJR/52.5	62	105	10	2	0.6	0.83	0.82	1.22	0.8	3.11
	110	90	71.5	2	0.6	302	440	3 000	4 000	46T32310JR/71.5	62	102	9	2	0.6	0.35	1.96	2.91	1.91	3.95
55	100	51	41.5	2	0.6	162	226	3 100	4 100	46T30211JR/41.5	65	94	4.5	2	0.6	0.4	1.67	2.48	1.63	1.6
	100	60	48.5	2	0.6	184	266	3 100	4 100	46T32211JR-1/48.5	65	95	5.5	2	0.6	0.4	1.67	2.48	1.63	1.87
	120	70	49	2	0.6	221	297	2 300	3 200	46T30311DJR/49	67	113	10.5	2	0.6	0.83	0.82	1.22	0.8	3.54
	120	70	57	2	0.6	256	341	2 700	3 600	46T30311JR/57	67	111	6.5	2	0.6	0.35	1.96	2.91	1.91	3.57
	120	97	76	2	0.6	343	500	2 700	3 600	46T32311JR/76	67	111	10.5	2	0.6	0.35	1.96	2.91	1.91	4.98
60	110	53	43.5	2	0.6	182	254	2 800	3 800	46T30212JR/43.5	70	103	4.5	2	0.6	0.4	1.67	2.48	1.63	2.04
	110	66	54.5	2	0.6	226	334	2 800	3 800	46T32212JR/54.5	70	104	5.5	2	0.6	0.4	1.67	2.48	1.63	—
	130	74	51	2.5	1	262	359	2 100	2 900	46T30312DJR/51	74	124	11.5	2.5	1	0.83	0.82	1.22	0.8	4.45
	130	74	59	2.5	1	297	401	2 500	3 300	46T30312JR/59	74	120	7.5	2.5	1	0.35	1.96	2.91	1.91	4.46

[Remark] Bearings not shown above (e.g. inch series) are shown in catalog "large size ball & roller bearings".

Double-row tapered roller bearings

TDO type

d (60) ~ (90) mm

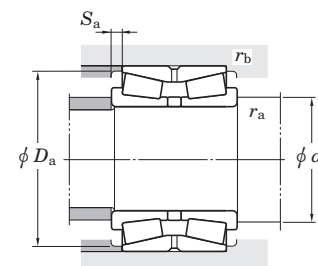
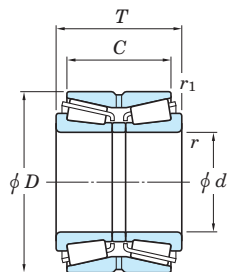

Boundary dimensions (mm)						Basic load ratings (kN)		Limiting speeds (min ⁻¹)		Bearing No.	Mounting dimensions (mm)					Constant e	Axial load factors			(Refer.) Mass (kg)
d	D	T	C	r min.	r ₁ min.	C _r	C _{0r}	Grease lub.	Oil lub.		d _a min.	D _a min.	S _a min.	r _a max.	r _b max.		Y ₂	Y ₃	Y ₀	
60	130	104	81	2.5	1	419	629	2 500	3 300	46T32312JR/81	74	120	11.5	2.5	1	0.35	1.96	2.91	1.91	6.45
65	120	56	46.5	2	0.6	220	311	2 600	3 400	46T30213JR/46.5	75	113	4.5	2	0.6	0.4	1.67	2.48	1.63	—
	120	73	61.5	2	0.6	270	406	2 600	3 400	46T32213JR/61.5	75	115	5.5	2	0.6	0.4	1.67	2.48	1.63	3.4
	140	79	53	2.5	1	302	417	1 900	2 700	46T30313DJR/53	79	133	13	2.5	1	0.83	0.82	1.22	0.8	5.3
	140	79	63	2.5	1	349	478	2 300	3 000	46T30313JR/63	79	130	8	2.5	1	0.35	1.96	2.91	1.91	5.51
	140	108	84	2.5	1	474	714	2 300	3 100	46T32313JR/84	79	130	12	2.5	1	0.35	1.96	2.91	1.91	7.71
70	125	59	48.5	2	0.6	236	346	2 400	3 300	46T30214JR/48.5	80	118	5	2	0.6	0.42	1.61	2.39	1.57	—
	125	74	61.5	2	0.6	290	450	2 400	3 300	46T32214JR/61.5	80	119	6	2	0.6	0.42	1.61	2.39	1.57	3.7
	150	83	57	2.5	1	338	470	1 800	2 500	46T30314DJR/57	84	142	13	2.5	1	0.83	0.82	1.22	0.8	6.48
	150	83	67	2.5	1	394	546	2 100	2 800	46T30314JR/67	84	140	8	2.5	1	0.35	1.96	2.91	1.91	6.65
	150	116	92	2.5	1	543	829	2 200	2 900	46T32314JR/92	84	140	12	2.5	1	0.35	1.96	2.91	1.91	9.46
75	115	30	26	1.5	0.6	71.7	105	2 500	3 300	46215	83.5	106.5	2	1.5	0.6	0.32	2.12	3.15	2.07	0.994
	115	38	30	1.5	0.6	122	207	2 500	3 300	46215A	83.5	107.4	4	1.5	0.6	0.32	2.12	3.15	2.07	1.32
	130	62	51.5	2	0.6	244	362	2 300	3 100	46T30215JR/51.5	85	124	5	2	0.6	0.44	1.55	2.31	1.52	3.12
	130	74	61.5	2	0.6	298	469	2 300	3 100	46T32215JR/61.5	85	125	6	2	0.6	0.44	1.55	2.31	1.52	3.85
	160	87	69	2.5	1	445	621	2 000	2 600	46T30315JR/69	89	149	9	2.5	1	0.35	1.96	2.91	1.91	7.8
	160	125	99	2.5	1	622	963	2 000	2 700	46T32315JR/99	89	149	13	2.5	1	0.35	1.96	2.91	1.91	11.5
80	125	34	30	1.5	0.6	108	155	2 300	3 100	46216	88.5	116.9	2	1.5	0.6	0.35	1.95	2.90	1.91	1.38
	140	64	51.5	2	0.6	277	405	2 200	2 900	46T30216JR/51.5	92	132	6	2	0.6	0.42	1.61	2.39	1.57	3.76
	140	78	63.5	2	0.6	347	542	2 200	2 900	46T32216JR/63.5	92	134	7	2	0.6	0.42	1.61	2.39	1.57	4.71
	170	92	73	2.5	1	504	711	1 800	2 500	46T30316JR/73	94	159	9.5	2.5	1	0.35	1.96	2.91	1.91	9.44
85	150	70	57	2	0.6	313	463	2 000	2 700	46T30217JR/57	97	141	6.5	2	0.6	0.42	1.61	2.39	1.57	4.79
	150	86	69	2	0.6	398	630	2 000	2 700	46T32217JR/69	97	142	8.5	2	0.6	0.42	1.61	2.39	1.57	6.05
	180	98	77	3	1	543	768	1 700	2 300	46T30317JR/77	103	167	10.5	3	1	0.35	1.96	2.91	1.91	11
	180	137	108	3	1	752	1 170	1 800	2 400	46T32317JR/108	103	167	14.5	3	1	0.35	1.96	2.91	1.91	16
90	140	37	33	2	0.6	136	199	2 100	2 800	46218	100	130.6	2	2	0.6	0.35	1.95	2.90	1.91	1.89

[Remark] Bearings not shown above (e.g. inch series) are shown in catalog "large size ball & roller bearings".

Double-row tapered roller bearings

TDO type

d (90) ~ 110 mm

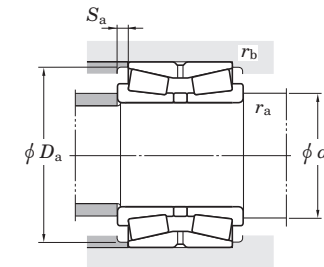
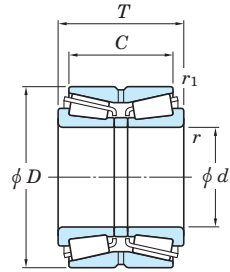

Boundary dimensions (mm)						Basic load ratings (kN)		Limiting speeds (min ⁻¹)		Bearing No.	Mounting dimensions (mm)					Constant e	Axial load factors			(Refer.) Mass (kg)	
d	D	T	C	r min.	r1 min.	Cr	C0r	Grease lub.	Oil lub.		da min.	Da min.	Sa min.	ra max.	rb max.		Y2	Y3	Y0		
90	140	46	37	2	0.6	157	266	2 000	2 700	46218A	100	129.9	4.5	2	0.6	0.32	2.12	3.15	2.07	2.37	
	160	74	61	2	0.6	350	522	1 900	2 500		46T30218JR/61	102	150	6.5	2	0.6	0.42	1.61	2.39	1.57	5.85
	160	94	77	2	0.6	451	724	1 900	2 500		46T32218JR/77	102	152	8.5	2	0.6	0.42	1.61	2.39	1.57	7.53
	190	102	81	3	1	592	841	1 600	2 200		46T30318JR/81	108	177	10.5	3	1	0.35	1.96	2.91	1.91	13
	190	144	115	3	1	791	1 230	1 700	2 200		46T32318JR/115	108	177	14.5	3	1	0.35	1.96	2.91	1.91	18.6
95	170	78	63	2.5	1	396	598	1 800	2 400	46T30219JR/63	109	159	7.5	2.5	1	0.42	1.61	2.39	1.57	7.01	
	170	100	83	2.5	1	533	877	1 800	2 400		46T32219JR/83	109	161	8.5	2.5	1	0.42	1.61	2.39	1.57	9.25
	200	108	85	3	1	638	909	1 600	2 100		46T30319JR/85	113	186	11.5	3	1	0.35	1.96	2.91	1.91	14.8
	200	151	118	3	1	886	1 390	1 600	2 100		46T32319JR/118	113	186	16.5	3	1	0.35	1.96	2.91	1.91	21.4
100	150	46	37	2	0.6	180	293	1 900	2 500	46220A	110	142	4.5	2	0.6	0.35	1.95	2.90	1.91	2.53	
	165	52	46	2.5	0.6	198	305	1 700	2 300		46320	112	154	3	2	0.6	0.35	1.95	2.90	1.91	4.03
	165	65	52	2.5	0.6	265	443	1 800	2 300		46320A	112	153	6.5	2	0.6	0.35	1.95	2.90	1.91	4.97
	180	83	67	2.5	1	443	676	1 700	2 200		46T30220JR/67	114	168	8	2.5	1	0.42	1.61	2.39	1.57	8.33
	180	107	87	2.5	1	596	990	1 700	2 200		46T32220JR/87	114	171	10	2.5	1	0.42	1.61	2.39	1.57	11.1
	215	112	87	3	1	724	1 040	1 500	1 900		46T30320JR/87	118	200	12.5	3	1	0.35	1.96	2.91	1.91	18.1
	215	162	127	3	1	993	1 570	1 500	2 000		46T32320JR/127	118	200	17.5	3	1	0.35	1.96	2.91	1.91	27.2
105	190	88	70	2.5	1	494	761	1 600	2 100	46T30221JR/70	119	178	9	2.5	1	0.42	1.61	2.39	1.57	9.87	
	190	115	95	2.5	1	672	1 130	1 600	2 100		46T32221JR/95	119	180	10	2.5	1	0.42	1.61	2.39	1.57	13.5
	225	116	91	3	1	796	1 160	1 400	1 800		46T30321JR/91	123	209	12.5	3	1	0.35	1.96	2.91	1.91	20.7
	225	170	133	3	1	1 090	1 730	1 400	1 900		46T32321JR/133	123	209	18.5	3	1	0.35	1.96	2.91	1.91	30.9
110	170	45	40	2.5	0.6	175	304	1 700	2 200	46222	122	158	2.5	2	0.6	0.35	1.95	2.90	1.91	3.58	
	180	56	50	2.5	0.6	245	388	1 600	2 100		46322	122	168	3	2	0.6	0.35	1.95	2.90	1.91	5.13
	180	70	56	2.5	0.6	324	533	1 600	2 100		46322A	122	168	7	2	0.6	0.35	1.92	2.86	1.88	6.43
	200	92	74	2.5	1	556	868	1 500	2 000		46T30222JR/74	124	188	9	2.5	1	0.42	1.61	2.39	1.57	11.6
	200	121	101	2.5	1	750	1 280	1 500	2 000		46T32222JR/101	124	190	10	2.5	1	0.42	1.61	2.39	1.57	15.9
	240	118	93	3	1	824	1 180	1 300	1 700		46T30322JR/93	128	222	12.5	3	1	0.35	1.96	2.91	1.91	23.8
	240	181	142	3	1	1 190	1 890	1 300	1 700		46T32322JR/142	128	222	19.5	3	1	0.35	1.96	2.91	1.91	37.3

[Remark] Bearings not shown above (e.g. inch series) are shown in catalog "large size ball & roller bearings".

Double-row tapered roller bearings

TDO type

d 120 ~ (150) mm

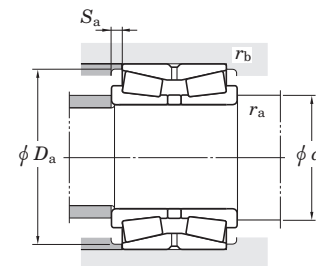
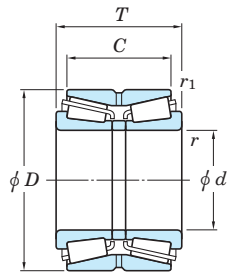

Boundary dimensions (mm)						Basic load ratings (kN)		Limiting speeds (min ⁻¹)		Bearing No.	Mounting dimensions (mm)					Constant e	Axial load factors			(Refer.) Mass (kg)
d	D	T	C	r min.	r ₁ min.	C _r	C _{0r}	Grease lub.	Oil lub.		d _a min.	D _a min.	S _a min.	r _a max.	r _b max.		Y ₂	Y ₃	Y ₀	
120	180	46	41	2.5	0.6	185	317	1 500	2 000	46224 46224A 46324 46324A 46324AS 46T30224JR/78 46T32224JR/109 46T30324JR/101 46T32324JR/145	132	170	2.5	2	0.6	0.35	1.95	2.90	1.91	3.81
	180	58	46	2.5	0.6	247	460	1 500	2 100		132	169	6	2	0.6	0.35	1.95	2.90	1.91	4.66
	200	62	55	2.5	0.6	292	470	1 400	1 900		132	184	3.5	2	0.6	0.35	1.95	2.90	1.91	7.28
	200	78	62	2.5	0.6	387	672	1 400	1 900		132	185	8	2	0.6	0.35	1.95	2.90	1.91	9.14
	200	100	84	2.5	0.6	533	1 010	1 400	1 900		132	190	8	2	0.6	0.35	1.95	2.90	1.91	12.0
	215	97	78	2.5	1	595	945	1 400	1 800		134	203	9.5	2.5	1	0.44	1.55	2.31	1.52	13.9
	215	132	109	2.5	1	806	1 380	1 400	1 900		134	204	11.5	2.5	1	0.44	1.55	2.31	1.52	19.8
	260	128	101	3	1	976	1 430	1 200	1 600		138	239	13.5	3	1	0.35	1.96	2.91	1.91	30.6
	260	188	145	4	1.5	1 370	2 210	1 200	1 600		142	239	21.5	4	1.5	0.35	1.96	2.91	1.91	45.9
130	200	52	46	2.5	0.6	239	425	1 400	1 800	46226 46226A 46326 46326A 46T30226JR/78.5 46T32226JR/117.5 46T30326JR/107.5	142	187	3	2	0.6	0.35	1.95	2.90	1.91	5.57
	200	65	52	2.5	0.6	319	618	1 400	1 900		142	185	6.5	2	0.6	0.35	1.95	2.90	1.91	7.06
	210	64	57	2.5	0.6	322	535	1 400	1 800		142	196	3.5	2	0.6	0.36	1.87	2.79	1.83	7.81
	210	80	64	2.5	0.6	424	723	1 300	1 800		142	198	8	2	0.6	0.36	1.87	2.79	1.83	9.57
	230	98	78.5	3	1	646	1 020	1 300	1 700		148	218	9.5	3	1	0.44	1.55	2.31	1.52	15.7
	230	145	117.5	3	1	949	1 660	1 300	1 700		148	219	14	3	1	0.44	1.55	2.31	1.52	24.1
	280	137	107.5	4	1.5	1 130	1 670	1 100	1 400		152	255	15	4	1.5	0.35	1.96	2.91	1.91	38.1
140	210	53	47	2.5	0.6	239	404	1 300	1 800	46228 46228A 46328 46328A 46T30228JR/82.5 46T32228JR/125.5 46T30328JR/115.5	152	196	3	2	0.6	0.33	2.03	3.02	1.98	5.85
	210	66	53	2.5	0.6	360	639	1 300	1 800		152	199	6.5	2	0.6	0.47	1.43	2.12	1.40	7.18
	225	68	61	3	1	360	564	1 200	1 700		154	210	3.5	2.5	1	0.35	1.95	2.90	1.91	9.56
	225	85	68	3	1	475	836	1 200	1 700		154	212	8	2.5	1	0.35	1.95	2.90	1.91	11.8
	250	102	82.5	3	1	720	1 140	1 200	1 500		158	237	9.5	3	1	0.44	1.55	2.31	1.52	19.7
	250	153	125.5	3	1	1 090	1 920	1 200	1 600		158	238	14	3	1	0.44	1.55	2.31	1.52	30.2
	300	145	115.5	4	1.5	1 280	1 920	1 000	1 300		162	273	15	4	1.5	0.35	1.96	2.91	1.91	46.6
	150	225	56	50	3	1	278	476	1 200		1 600	46230 46230A 46330 46330A 46T30230JR/87	164	213	3	2.5	1	0.33	2.03	3.02
225		70	56	3	1	377	703	1 200	1 600	164	213		7	2.5	1	0.33	2.03	3.02	1.98	8.82
250		80	71	3	1	467	786	1 100	1 500	164	233		4.5	2.5	1	0.35	1.95	2.90	1.91	14.6
250		100	80	3	1	595	1 070	1 100	1 500	164	234		10	2.5	1	0.35	1.95	2.90	1.91	17.6
270		109	87	3	1	827	1 330	1 100	1 400	168	255		11	3	1	0.44	1.55	2.31	1.52	24.6

[Remark] Bearings not shown above (e.g. inch series) are shown in catalog "large size ball & roller bearings".

Double-row tapered roller bearings

TDO type

d (150) ~ (200) mm

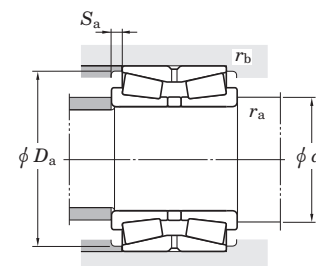
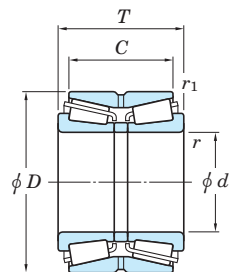

Boundary dimensions (mm)						Basic load ratings (kN)		Limiting speeds (min ⁻¹)		Bearing No.	Mounting dimensions (mm)					Constant e	Axial load factors			(Refer.) Mass (kg)
d	D	T	C	r min.	r1 min.	Cr	Cor	Grease lub.	Oil lub.		da min.	Da min.	Sa min.	ra max.	rb max.		Y2	Y3	Y0	
150	270	164	130	3	1	1 210	2 130	1 100	1 400	46T32230JR/130 46T30330JR/120	168	254	17	3	1	0.44	1.55	2.31	1.52	38
	320	154	120	4	1.5	1 430	2 160	930	1 200		172	292	17	4	1.5	0.35	1.96	2.91	1.91	56
160	240	60	53	3	1	324	565	1 100	1 500	46232 46232A 46332 46332A 46T30232JR/91 46T32232JR/144	174	228	3.5	2.5	1	0.33	2.03	3.02	1.98	8.71
	240	75	60	3	1	406	756	1 100	1 500		174	226	7.5	2.5	1	0.33	2.03	3.02	1.98	10.6
	270	86	76	3	1	592	950	1 000	1 400		174	252	5	2.5	1	0.35	1.95	2.90	1.91	18.8
	270	108	86	3	1	727	1 270	1 000	1 400		174	252	11	2.5	1	0.35	1.95	2.90	1.91	23.1
	290	115	91	3	1	929	1 500	980	1 300		178	269	12	3	1	0.44	1.55	2.31	1.52	29.9
	290	178	144	3	1	1 360	2 420	1 000	1 300		178	274	17	3	1	0.44	1.55	2.31	1.52	47.6
170	260	67	60	3	1	382	642	1 000	1 400	46234 46234A 46334 46334A 46T30234JR/97 46T32234JR/152	184	243	3.5	2.5	1	0.33	2.03	3.02	1.98	11.4
	260	84	67	3	1	502	969	1 000	1 400		184	244	8.5	2.5	1	0.33	2.03	3.02	1.98	14.7
	280	88	78	3	1	599	1 050	970	1 300		184	263	5	2.5	1	0.33	2.06	3.06	2.01	19.8
	280	110	88	3	1	776	1 390	980	1 300		184	260	11	2.5	1	0.33	2.06	3.06	2.01	24.7
	310	125	97	4	1.5	1 060	1 730	900	1 200		192	288	14	4	1.5	0.44	1.55	2.31	1.52	37.5
	310	192	152	4	1.5	1 540	2 760	910	1 200		192	294	20	4	1.5	0.44	1.55	2.31	1.52	58.8
180	280	74	66	3	1	464	801	950	1 300	46236 46236A 46336 46336A 46T30236JR/99 46T32236JR/152	194	263	4	2.5	1	0.33	2.03	3.02	1.98	15.5
	280	93	74	3	1	584	1 080	960	1 300		194	261	9.5	2.5	1	0.33	2.03	3.02	1.98	19.0
	300	96	85	4	1.5	693	1 240	910	1 200		198	277	5.5	3	1.5	0.33	2.06	3.06	2.01	25.8
	300	120	96	4	1.5	894	1 630	900	1 200		198	279	12	3	1.5	0.33	2.06	3.06	2.01	31.3
	320	127	99	4	1.5	1 060	1 740	860	1 200		202	297	14	4	1.5	0.45	1.5	2.23	1.47	40.1
	320	192	152	4	1.5	1 640	3 030	880	1 200		202	303	20	4	1.5	0.45	1.5	2.23	1.47	62.5
190	290	75	67	3	1	487	866	910	1 200	46238 46238A 46338 46338A 46T30238JR/105 46T32238JR/160	204	272	4	2.5	1	0.32	2.12	3.15	2.07	16.5
	290	94	75	3	1	632	1 170	900	1 200		204	274	9.5	2.5	1	0.33	2.03	3.02	1.98	20.0
	320	104	92	4	1.5	808	1 450	830	1 100		208	298	6	3	1.5	0.35	1.95	2.90	1.91	31.9
	320	130	104	4	1.5	1 020	1 860	840	1 100		208	298	13	3	1.5	0.35	1.95	2.90	1.91	39.0
	340	133	105	4	1.5	1 250	2 060	800	1 100		212	318	14	4	1.5	0.44	1.55	2.31	1.52	47.8
	340	204	160	4	1.5	1 870	3 480	810	1 100		212	323	22	4	1.5	0.44	1.55	2.31	1.52	75.1
200	310	82	73	3	1	572	1 040	850	1 100	46240	214	288	4.5	2.5	1	0.32	2.12	3.15	2.07	21.4

[Remark] Bearings not shown above (e.g. inch series) are shown in catalog "large size ball & roller bearings".

Double-row tapered roller bearings

TDO type

d (200) ~ (300) mm

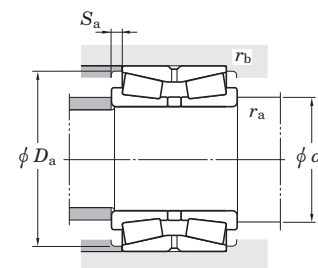
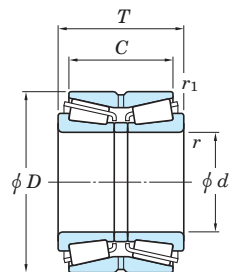

Boundary dimensions (mm)						Basic load ratings (kN)		Limiting speeds (min ⁻¹)		Bearing No.	Mounting dimensions (mm)					Constant e	Axial load factors			(Refer.) Mass (kg)	
d	D	T	C	r min.	r1 min.	Cr	C0r	Grease lub.	Oil lub.		da min.	Da min.	Sa min.	ra max.	rb max.		Y2	Y3	Y0		
200	310	103	82	3	1	713	1 380	840	1 100	46240A	214	289	10.5	2.5	1	0.32	2.12	3.15	2.07	26.3	
	340	112	100	4	1.5	939	1 580	780	1 000		46340	218	316	6	3	1.5	0.35	1.95	2.90	1.91	39.6
	340	140	112	4	1.5	1 110	2 040	770	1 000		46340A	218	319	14	3	1.5	0.35	1.95	2.90	1.91	48.2
	360	142	110	4	1.5	1 360	2 240	750	1 000		46T30240JR/110	222	336	16	4	1.5	0.44	1.55	2.31	1.52	56.5
	360	218	174	4	1.5	2 130	3 760	770	1 000		46T32240JR/174	222	340	22	4	1.5	0.41	1.66	2.47	1.62	88.2
220	340	90	80	4	1.5	677	1 240	750	990	46244	238	319	5	3	1.5	0.32	2.12	3.15	2.07	27.8	
	340	113	90	4	1.5	832	1 620	750	1 000		46244A	238	318	11.5	3	1.5	0.32	2.12	3.15	2.07	34.2
	370	120	107	5	1.5	1 070	1 810	700	930		46344	242	346	6.5	4	1.5	0.35	1.95	2.90	1.91	49.1
	370	150	120	5	1.5	1 330	2 470	710	940		46344A	242	343	15	4	1.5	0.35	1.95	2.90	1.91	60.1
	400	150	114	4	1.5	1 730	2 880	660	890		46T30244JR/114	242	371	18	4	1.5	0.42	1.61	2.39	1.57	75.8
240	360	92	82	4	1.5	768	1 430	690	920	46248	258	338	5	3	1.5	0.32	2.12	3.15	2.07	29.6	
	360	115	92	4	1.5	990	1 980	690	920		46248A	258	341	11.5	3	1.5	0.32	2.12	3.15	2.07	36.9
	400	128	114	5	1.5	1 190	2 180	630	840		46348	262	377	7	4	1.5	0.35	1.95	2.90	1.91	59.0
	400	160	128	5	1.5	1 540	3 060	630	850		46348A	262	373	16	4	1.5	0.35	1.95	2.90	1.91	76.2
260	400	104	92	5	1.5	935	1 830	610	820	46252	282	373	6	4	1.5	0.33	2.03	3.02	1.98	44.6	
	400	130	104	5	1.5	1 210	2 480	610	810		46252A	282	376	13	4	1.5	0.32	2.12	3.15	2.07	54.8
	440	144	128	5	1.5	1 510	2 880	560	750		46352	282	410	8	4	1.5	0.35	1.95	2.90	1.91	83.8
	440	180	144	5	1.5	2 010	3 960	570	760		46352A	282	409	18	4	1.5	0.35	1.95	2.90	1.91	105
280	420	106	94	5	1.5	1 010	1 970	570	760	46256	302	395	6	4	1.5	0.33	2.03	3.02	1.98	46.9	
	420	133	106	5	1.5	1 250	2 610	570	760		46256A	302	394	13.5	4	1.5	0.33	2.03	3.02	1.98	58.9
	460	146	130	6	2	1 550	2 930	530	700		46356	308	430	8	5	2	0.35	1.95	2.90	1.91	90.0
	460	183	146	6	2	2 040	3 940	520	690		46356A	308	434	18.5	5	2	0.35	1.95	2.90	1.91	111
300	460	118	105	5	1.5	1 290	2 400	500	670	46260	322	436	6.5	4	1.5	0.32	2.12	3.15	2.07	64.6	
	460	148	118	5	1.5	1 630	3 230	510	680		46260A	322	433	15	4	1.5	0.32	2.12	3.15	2.07	80.2
	500	160	142	6	2	1 980	3 540	470	620		46360	328	469	9	5	2	0.35	1.95	2.90	1.91	116
	500	200	160	6	2	2 270	4 630	470	630		46360A	328	466	20	5	2	0.35	1.95	2.90	1.91	144

[Remark] Bearings not shown above (e.g. inch series) are shown in catalog "large size ball & roller bearings".

Double-row tapered roller bearings

TDO type

d (300) ~ 420 mm

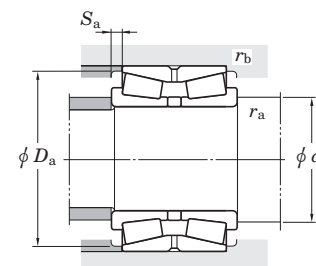
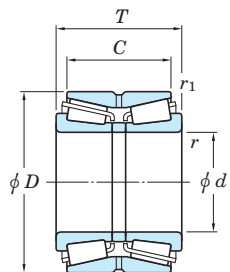

Boundary dimensions (mm)						Basic load ratings (kN)		Limiting speeds (min ⁻¹)		Bearing No.	Mounting dimensions (mm)					Constant e	Axial load factors			(Refer.) Mass (kg)
d	D	T	C	r min.	r1 min.	Cr	C0r	Grease lub.	Oil lub.		da min.	Da min.	Sa min.	ra max.	rb max.		Y2	Y3	Y0	
300	500	200	160	6	1.5	2 500	4 650	—	—	46360D	328	475	20	5	1.5	0.40	1.68	2.50	1.64	139
320	480	121	108	5	1.5	1 430	2 700	480	640	46264	342	452	6.5	4	1.5	0.32	2.12	3.15	2.07	71.6
	480	151	121	5	1.5	1 650	3 410	470	630	46264A	342	454	15	4	1.5	0.32	2.12	3.15	2.07	87.7
	540	176	157	6	2	2 440	4 570	420	560	46364	348	502	9.5	5	2	0.35	1.95	2.90	1.91	154
	540	220	176	6	2	2 610	5 390	430	570	46364A	348	497	22	5	2	0.35	1.95	2.90	1.91	190
340	520	133	118	6	2	1 550	3 070	420	570	46268	368	489	7.5	5	2	0.32	2.12	3.15	2.07	95.3
	520	165	133	6	2	1 930	4 060	420	560	46268A	368	491	16	5	2	0.32	2.12	3.15	2.07	117
	580	190	169	6	2	2 540	4 620	380	510	46368	368	539	10.5	5	2	0.35	1.95	2.90	1.91	198
	580	238	190	6	2	3 160	6 340	370	500	46368A	368	543	24	5	2	0.35	1.95	2.90	1.91	244
360	540	134	120	6	2	1 660	3 290	400	530	46272	388	510	7	5	2	0.32	2.12	3.15	2.07	93.0
	540	169	134	6	2	2 020	4 230	390	530	46272A	388	512	17.5	5	2	0.32	2.12	3.15	2.07	124
	600	192	171	6	2	2 680	4 880	360	480	46372	388	557	10.5	5	2	0.35	1.95	2.90	1.91	206
	600	240	192	6	2	3 660	7 230	360	480	46372A	388	568	24	5	2	0.39	1.74	2.59	1.70	254
380	560	135	122	6	2	1 740	3 560	370	500	46276	408	530	6.5	5	2	0.32	2.12	3.15	2.07	100
	560	171	135	6	2	2 240	4 670	380	500	46276A	408	531	18	5	2	0.39	1.74	2.59	1.70	129
	620	194	173	6	2	2 870	5 220	340	450	46376	408	582	10.5	5	2	0.39	1.74	2.59	1.70	215
	620	243	194	6	2	3 490	7 360	330	440	46376A	408	587	24.5	5	2	0.35	1.95	2.90	1.91	265
400	600	148	132	6	2	1 870	3 720	340	460	46280	428	560	8	5	2	0.32	2.12	3.15	2.07	135
	600	185	148	6	2	2 420	5 150	340	460	46280A	428	563	18.5	5	2	0.32	2.12	3.15	2.07	167
	650	200	178	6	3	2 980	5 920	320	420	46380	428	605	11	5	2.5	0.35	1.95	2.90	1.91	243
	650	250	200	6	3	4 060	8 850	310	420	46380A	428	610	25	5	2.5	0.35	1.95	2.90	1.91	306
420	620	150	134	6	2	2 010	4 130	320	420	46284	448	590	8	5	2	0.33	2.03	3.02	1.98	142
	620	188	150	6	2	2 700	5 660	320	430	46284A	448	589	19	5	2	0.39	1.74	2.59	1.70	176
	700	224	200	6	3	3 700	6 880	290	380	46384	448	656	12	5	2.5	0.39	1.74	2.59	1.70	325
	700	280	224	6	3	4 810	9 620	290	380	46384A	448	659	28	5	2.5	0.39	1.74	2.59	1.70	400

[Remark] Bearings not shown above (e.g. inch series) are shown in catalog "large size ball & roller bearings".

Double-row tapered roller bearings

TDO type

d 440 ~ 500 mm

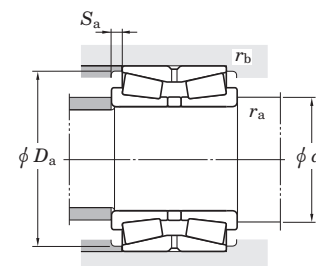
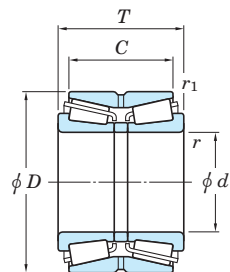

d	Boundary dimensions (mm)					Basic load ratings (kN)		Limiting speeds (min ⁻¹)		Bearing No.	Mounting dimensions (mm)					Constant e	Axial load factors			(Refer.) Mass (kg)
	D	T	C	r _{min.}	r _{1 min.}	C _r	C _{0r}	Grease lub.	Oil lub.		d _{a min.}	D _{a min.}	S _{a min.}	r _{a max.}	r _{b max.}		Y ₂	Y ₃	Y ₀	
440	650	157	140	6	3	2 260	4 430	300	390	46288 46288A 46388 46388A	468	622	8.5	5	2.5	0.33	2.03	3.02	1.98	156
	650	196	157	6	3	3 000	6 370	300	400		468	620	19.5	5	2.5	0.39	1.74	2.59	1.70	198
	720	226	201	6	3	3 940	8 110	270	360		468	676	12.5	5	2.5	0.39	1.74	2.59	1.70	354
	720	283	226	6	3	4 940	10 100	270	360		468	679	28.5	5	2.5	0.40	1.68	2.51	1.65	418
460	680	163	145	6	3	2 500	5 340	280	370	46292 46292A 46392 46392A	488	637	9	5	2.5	0.37	1.83	2.72	1.78	196
	680	204	163	6	3	3 220	6 850	280	370		488	646	20.5	5	2.5	0.39	1.74	2.59	1.70	232
	760	240	214	7.5	4	4 580	9 000	250	330		496	710	13	6	3	0.39	1.74	2.59	1.70	424
	760	300	240	7.5	4	5 680	11 600	250	330		496	718	30	6	3	0.39	1.74	2.59	1.70	506
480	700	165	147	6	3	2 530	5 300	260	340	46296 46296A 46396 46396A	508	672	9	5	2.5	0.33	2.03	3.02	1.98	186
	700	206	165	6	3	3 220	7 230	260	340		508	666	20.5	5	2.5	0.33	2.03	3.02	1.98	240
	790	248	221	7.5	4	4 640	8 920	230	310		516	742	13.5	6	3	0.39	1.74	2.59	1.70	457
	790	310	248	7.5	4	5 990	12 400	230	310		516	749	31	6	3	0.39	1.74	2.59	1.70	560
500	720	167	149	6	3	2 580	5 690	250	330	462/500 462/500A 463/500 463/500A	528	679	9	5	2.5	0.40	1.71	2.54	1.67	210
	720	209	167	6	3	3 500	7 850	250	330		528	690	21	5	2.5	0.42	1.62	2.41	1.58	258
	830	264	235	7.5	4	5 220	10 900	210	280		536	776	14.5	6	3	0.39	1.74	2.59	1.70	559
	830	330	264	7.5	4	6 780	14 000	210	280		536	784	33	6	3	0.39	1.74	2.59	1.70	669

[Remark] Bearings not shown above (e.g. inch series) are shown in catalog "large size ball & roller bearings".

Double-row tapered roller bearings

TDI type

d 100 ~ (220) mm

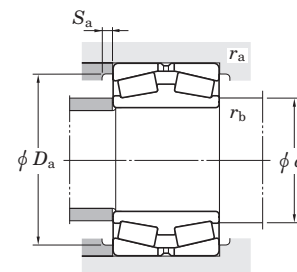
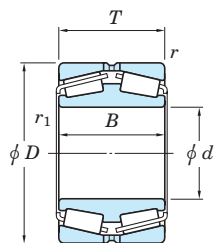

Boundary dimensions (mm)						Basic load ratings (kN)		Limiting speeds (min ⁻¹)		Bearing No.	Mounting dimensions (mm)					Constant e	Axial load factors			(Refer.) Mass (kg)	
d	D	B	T	r min.	r1 min.	Cr	C0r	Grease lub.	Oil lub.		da max.	Da max.	Da min.	Sa min.	ra max.		rb max.	Y2	Y3		Y0
100	165	52	52	2	2.5	237	384	1 800	2 300	45320	119	155	148	3.9	2	2	0.35	1.95	2.90	1.91	4.26
	180	56	56	2	2.5	300	505	1 600	2 100		45322	128	170	160	4	2	2	0.35	1.95	2.90	1.91
120	180	46	46	2	2.5	229	424	1 500	2 100	45224 45324	138	170	163	4	2	2	0.26	2.55	3.80	2.50	4.08
	200	62	62	2	2.5	353	598	1 400	1 900		45324	142	190	178	4	2	2	0.35	1.95	2.90	1.91
130	200	52	52	2	2.5	300	548	1 400	1 800	45226 45326	152	190	179	4	2	2	0.27	2.47	3.67	2.41	5.96
	210	64	64	2	2.5	412	657	1 300	1 800		45326	153	200	185	4	2	2	0.36	1.87	2.79	1.83
140	210	53	53	2	2.5	311	564	1 300	1 800	45228 45328	159	200	188	4	2	2	0.27	2.47	3.67	2.41	6.45
	225	68	68	2.5	3	486	807	1 200	1 700		45328	160	213	210	4	2	2.5	0.40	1.68	2.50	1.64
150	225	56	56	2.5	3	355	686	1 200	1 600	45230 45330	174	213	203	4	2	2.5	0.26	2.55	3.80	2.50	7.87
	250	80	80	2.5	3	593	955	1 100	1 500		45330	179	238	220	4	2	2.5	0.35	1.95	2.90	1.91
160	240	60	60	2.5	3	421	705	1 100	1 500	45232 45332	184	228	217	5	2	2.5	0.24	2.79	4.15	2.73	9.22
	270	86	86	2.5	3	678	1 100	1 000	1 400		45332	193	258	237	4	2	2.5	0.35	1.95	2.90	1.91
170	260	67	67	2.5	3	521	956	1 000	1 400	45234 45334	195	248	233	5	2	2.5	0.31	2.21	3.29	2.16	12.4
	280	88	88	2.5	3	723	1 210	970	1 300		45334	201	268	247	5	2	2.5	0.33	2.03	3.02	1.98
180	280	74	74	2.5	3	575	1 050	950	1 300	45236 45336	208	268	250	5	2	2.5	0.28	2.43	3.61	2.37	16.8
	300	96	96	3	4	860	1 370	910	1 200		45336	210	286	263	5	2.5	3	0.35	1.95	2.90	1.91
190	290	75	75	2.5	3	599	1 130	900	1 200	45238 45338	219	278	260	5	2	2.5	0.26	2.55	3.80	2.50	17.7
	320	104	104	3	4	981	1 590	840	1 100		45338	224	306	280	5	2.5	3	0.35	1.95	2.90	1.91
200	310	82	82	2.5	3	728	1 410	830	1 100	45240 45340	234	298	280	5	2	2.5	0.26	2.55	3.80	2.50	22.9
	340	112	112	3	4	1 080	1 840	770	1 000		45340	244	326	300	5	2.5	3	0.35	1.95	2.90	1.91
220	340	90	90	3	4	805	1 460	740	990	45244	259	326	306	5	2.5	3	0.28	2.43	3.61	2.37	28.5

[Remark] Bearings not shown above (e.g. inch series) are shown in catalog "large size ball & roller bearings".

Double-row tapered roller bearings

TDI type

d (220) ~ (420) mm

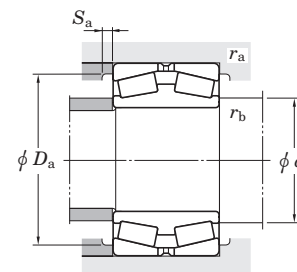
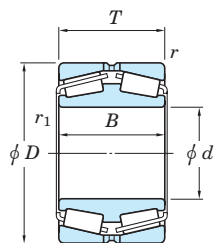

Boundary dimensions (mm)						Basic load ratings (kN)		Limiting speeds (min ⁻¹)		Bearing No.	Mounting dimensions (mm)					Constant e	Axial load factors			(Refer.) Mass (kg)	
d	D	B	T	$r_{min.}$	$r_{1 min.}$	C_r	C_{0r}	Grease lub.	Oil lub.		d_a max.	D_a max.	S_a min.	r_a max.	r_b max.		Y_2	Y_3	Y_0		
220	370	120	120	4	5	1 210	2 060	700	930	45344	263	352	324	5	3	4	0.35	1.95	2.90	1.91	50.8
	230	350	90	90	3	4	791	1 560	710		950	267	336	318	6	2.5	3	0.28	2.43	3.61	2.37
240	360	92	92	3	4	915	1 790	690	920	45248 45348	271	346	325	5	2.5	3	0.32	2.12	3.15	2.07	32.2
	400	128	128	4	5	1 430	2 470	630	840		286	382	354	5	3	4	0.35	1.95	2.90	1.91	65.4
260	400	104	104	4	5	1 140	2 120	610	810	45252 45352	302	382	360	6	3	4	0.25	2.74	4.08	2.68	48.1
	440	144	144	4	5	1 890	3 440	560	750		313	422	386	6	3	4	0.35	1.95	2.90	1.91	92.2
280	420	106	106	4	5	1 190	2 470	560	750	45256 45356	321	402	370	6	3	4	0.25	2.69	4.00	2.63	51.9
	460	146	146	5	6	1 930	3 320	520	700		323	438	409	6	4	5	0.39	1.74	2.59	1.70	93.1
300	460	118	118	4	5	1 610	3 150	500	670	45260 45360	350	442	418	6	3	4	0.25	2.74	4.08	2.68	78.5
	500	160	160	5	6	2 120	4 240	470	630		356	478	440	6	4	5	0.35	1.95	2.90	1.91	129
320	480	121	121	4	5	1 630	3 180	470	630	45264 45364R	368	462	434	6	3	4	0.26	2.55	3.80	2.50	77.8
	540	176	176	5	6	2 690	5 280	430	570		378	518	474	6	4	5	0.32	2.12	3.15	2.07	167
340	520	133	133	5	6	1 880	3 850	420	570	45268 45368	398	498	464	6	4	5	0.26	2.55	3.80	2.50	104
	580	190	190	5	6	3 290	5 470	390	510		401	558	515	6	4	5	0.32	2.12	3.15	2.07	202
360	540	134	134	5	6	2 050	3 910	400	540	45272 45372	408	518	488	11	4	5	0.32	2.12	3.15	2.07	101
	600	192	192	5	6	3 360	6 750	360	490		419	578	528	10	4	5	0.32	2.12	3.15	2.07	228
380	560	135	135	5	6	2 060	3 790	380	500	45276 45376	428	538	510	6	4	5	0.27	2.47	3.67	2.41	112
	620	194	194	5	6	3 070	6 360	340	450		445	598	545	6	4	5	0.32	2.12	3.15	2.07	234
400	600	148	148	5	6	2 410	4 960	340	450	45280 45380	452	578	545	6	4	5	0.33	2.03	3.02	1.98	143
	650	200	200	6	6	3 850	7 810	320	420		458	622	580	11	5	5	0.39	1.74	2.59	1.70	265
420	620	150	150	5	6	2 600	5 200	320	430	45284	475	598	564	6	4	5	0.33	2.03	3.02	1.98	152

[Remark] Bearings not shown above (e.g. inch series) are shown in catalog "large size ball & roller bearings".

Double-row tapered roller bearings

TDI type

d (420) ~ 500 mm

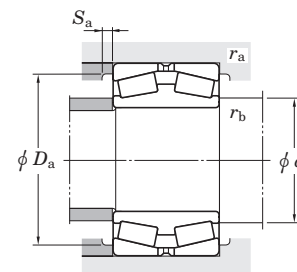
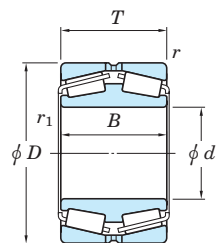

Boundary dimensions (mm)						Basic load ratings (kN)		Limiting speeds (min ⁻¹)		Bearing No.	Mounting dimensions (mm)					Constant e	Axial load factors			(Refer.) Mass (kg)	
d	D	B	T	$r_{min.}$	$r1_{min.}$	C_r	C_{0r}	Grease lub.	Oil lub.		d_a max.	D_a max.	S_a min.	r_a max.	r_b max.		Y_2	Y_3	Y_0		
420	700	224	224	6	6	4 710	8 380	280	380	45384	488	672	623	7	5	5	0.39	1.74	2.59	1.70	352
440	650	157	157	6	6	2 750	5 500	300	390	45288 45388	500	622	592	10	5	5	0.28	2.43	3.61	2.37	182
		720	226	226	6	6	4 990	9 130	270		360	506	692	642	7	5	5	0.39	1.74	2.59	1.70
460	680	163	163	6	6	3 000	5 660	280	370	45292 45392	510	652	616	6	5	5	0.39	1.74	2.59	1.70	197
		760	240	240	7.5	7.5	5 230	10 400	250		330	532	724	677	7	6	6	0.39	1.74	2.59	1.70
480	700	165	165	6	6	3 060	6 710	260	350	45296 45396	531	672	625	6	5	5	0.40	1.68	2.50	1.64	215
		790	248	248	7.5	7.5	5 710	11 600	230		310	555	754	703	7	6	6	0.39	1.74	2.59	1.70
500	720	167	167	6	6	3 430	7 350	250	330	452/500 453/500	545	692	645	8	5	5	0.39	1.74	2.59	1.70	222
		830	264	264	7.5	7.5	6 280	12 300	210		280	587	794	729	7	6	6	0.33	2.03	3.02	1.98

[Remark] Bearings not shown above (e.g. inch series) are shown in catalog "large size ball & roller bearings".

Spherical roller bearings

Spherical roller bearings feature a large load rating capacity and self-aligning capability.

This type of bearing is suitable for low- or medium-speed applications which involve heavy or impact loading.

- These bearings are divided into R(RR), RH(RHR) and RHA types, which differ in internal structure. (refer to Table 1.)
- Each type can be produced with a cylindrical bore or tapered bore.

Bearings with a tapered bore can be fit and removed easily using an adapter assembly or withdrawal sleeve.

The rate of taper is equivalent among all bearing series.
 240 and 241 series ... 1 : 30 (supplementary code "K30")
 Others ... 1 : 12 (supplementary code "K")

Spherical roller bearings



Cylindrical bore Tapered bore
 Bore diameter **25 – 500 mm**

Adapter assemblies



Bore diameter **20 – 470 mm**

Withdrawal sleeves



Bore diameter **35 – 480 mm**

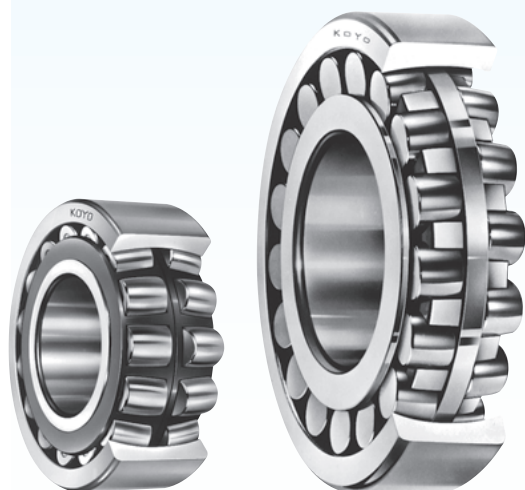



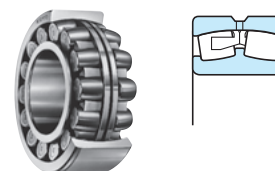

Table 1 Spherical roller bearings : types and structures

Structure	 R, RR type	 RH, RHR type	 RHA type
Roller	Convex asymmetrical roller	Convex symmetrical roller	Convex symmetrical roller
Cage	Copper alloy prong type machined cage	Pressed steel cage	Copper alloy integral type machined cage
Inner ring (with or without rib)	With center rib	Without center rib (guide ring)	Without center rib (guide ring)
	With ribs on both sides (to prevent rollers from falling)	Without ribs on both sides	With ribs on both sides (to prevent rollers from falling)
Characteristics	Superior to RH, RHR and RHA types in high-speed performance.	The load rating capacity is larger than that of R and RR type. (There are some exceptional cases due to different interior specifications.)	

Spherical roller bearings for shaker screens



- These bearings consist of convex asymmetric rollers and a prong type, copper alloy, outer ring guided, machined cage. This cage possesses optimum characteristics for use with shaker screens.
- The bearings most commonly used with shaker screens are 223 series spherical roller bearings. They are identified by the supplementary code "ROVS W502." The outer ring outside diameter tolerance of these bearings is held to a small allowable variation.

■ Bearings with lubrication holes and a lubrication groove

- Outer rings can be provided with lubrication holes, a lubrication groove and an anti-rotation pin hole. (Specifications are given in Table 4.)
- Inner rings can also be provided with lubrication holes and a lubrication groove.

Table 2 Supplementary codes for identification of bearings with lubrication holes, lubrication groove and anti-rotation pin hole (outer ring)

Supplementary code		Number of lubrication holes	Hole layout
With lubrication holes and lubrication groove	With lubrication holes, lubrication groove and anti-rotation pin hole		
W33	W3N	3 ¹⁾	3 equally spaced positions ¹⁾
W33A	W3NA	4	4 equally spaced positions
-	W3NB	5	6 equally spaced positions ²⁾
W33C	W3NC	6	6 equally spaced positions
-	W3ND	7	8 equally spaced positions ²⁾
W33T	-	8	8 equally spaced positions

[Notes] 1) Also 4 or 6 holes are provided in smaller size bearings, consult with JTEKT.
 2) One hole is used for the antirotation pin.

[Remark] Boldfaced codes indicate JTEKT standards.

Table 3 Supplementary codes for identification of bearings with lubrication holes and/or lubrication groove

Supplementary code	Inner ring		Outer ring	
	Number of lubrication holes	Lubrication groove	Number of lubrication holes	Lubrication groove
W513	3	-	3	○
W518	3	-	3	-
W26	3	-	-	-

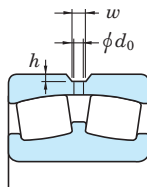

Table 4 (1) Lubrication hole and lubrication groove dimensions Unit : mm

Bore diameter number	Nominal bore diameter <i>d</i>	239			230			240			231			241			222			232			213			223						
		<i>d</i> ₀	<i>w</i>	<i>h</i>	<i>d</i> ₀	<i>w</i>	<i>h</i>	<i>d</i> ₀	<i>w</i>	<i>h</i>	<i>d</i> ₀	<i>w</i>	<i>h</i>	<i>d</i> ₀	<i>w</i>	<i>h</i>	<i>d</i> ₀	<i>w</i>	<i>h</i>	<i>d</i> ₀	<i>w</i>	<i>h</i>	<i>d</i> ₀	<i>w</i>	<i>h</i>	<i>d</i> ₀	<i>w</i>	<i>h</i>				
5	25	-	-	-	-	-	-	-	-	-	-	-	-	-	-	-	-	-	-	-	-	-	-	-	-	-	-	-	-	-	-	-
6	30	-	-	-	-	-	-	-	-	-	-	-	-	-	-	-	-	-	-	-	-	-	-	-	-	-	-	-	-	-	-	-
7	35	-	-	-	-	-	-	-	-	-	-	-	-	-	-	-	-	-	-	-	-	-	-	-	-	-	-	-	-	-	-	-
8	40	-	-	-	-	-	-	-	-	-	-	-	-	-	-	-	-	-	-	-	-	-	-	-	-	-	-	-	-	-	-	-
9	45	-	-	-	-	-	-	-	-	-	-	-	-	-	-	-	-	-	-	-	-	-	-	-	-	-	-	-	-	-	-	-
10	50	-	-	-	-	-	-	-	-	-	-	-	-	-	-	-	-	-	-	-	-	-	-	-	-	-	-	-	-	-	-	-
11	55	-	-	-	-	-	-	-	-	-	-	-	-	-	-	-	-	-	-	-	-	-	-	-	-	-	-	-	-	-	-	-
12	60	-	-	-	-	-	-	-	-	-	-	-	-	-	-	-	-	-	-	-	-	-	-	-	-	-	-	-	-	-	-	-
13	65	-	-	-	-	-	-	-	-	-	-	-	-	-	-	-	-	-	-	-	-	-	-	-	-	-	-	-	-	-	-	-
14	70	-	-	-	-	-	-	-	-	-	-	-	-	-	-	-	-	-	-	-	-	-	-	-	-	-	-	-	-	-	-	-
15	75	-	-	-	-	-	-	-	-	-	-	-	-	-	-	-	-	-	-	-	-	-	-	-	-	-	-	-	-	-	-	-
16	80	-	-	-	-	-	-	-	-	-	-	-	-	-	-	-	-	-	-	-	-	-	-	-	-	-	-	-	-	-	-	-
17	85	-	-	-	-	-	-	-	-	-	-	-	-	-	-	-	-	-	-	-	-	-	-	-	-	-	-	-	-	-	-	-
18	90	-	-	-	-	-	-	-	-	-	-	-	-	-	-	-	-	-	-	-	-	-	-	-	-	-	-	-	-	-	-	-
19	95	-	-	-	-	-	-	-	-	-	-	-	-	-	-	-	-	-	-	-	-	-	-	-	-	-	-	-	-	-	-	-
20	100	-	-	-	4	5	1	-	-	-	5	6	1.4	-	-	-	5	6	1.2	5	8	1.2	4	6	1.2	6	8	1.3	2	2	2	2
22	110	-	-	-	5	7	1	-	-	5	6	1.4	6	8	1.5	5	7	1.5	6	8	1.7	4	6	1.2	6	8	1.3	2	2	2	2	
24	120	-	-	-	5	7	1	5	6	1.4	5	6	1.4	6	8	1.5	5	7	1.5	6	10	1.7	-	-	-	-	-	-	8	10	2.5	2
26	130	-	-	-	5	7	1.2	6	8	1.5	5	6	1.5	6	8	1.5	5	7	1.5	6	10	1.7	-	-	-	-	-	-	8	12	2.5	2
28	140	4	5	1	5	7	1.2	6	8	1.5	6	8	1.5	8	10	2	6	8	1.8	8	10	2.5	-	-	-	-	-	12	14	3	3	
30	150	5	7	1	5	8	1.2	6	8	1.5	6	10	1.5	8	10	2	6	10	1.8	8	10	2.5	-	-	-	-	-	12	14	3	3	
32	160	5	7	1.2	5	8	1.2	6	8	1.5	8	12	2	10	12	2	10	12	2.5	10	12	2.5	-	-	-	-	-	12	14	3	3	
34	170	5	7	1.2	6	10	1.5	8	10	2	8	12	2	10	12	2	12	14	3	10	12	2.5	-	-	-	-	-	12	14	3	3	
36	180	6	7	1.3	8	12	1.5	10	12	2.5	10	12	2.5	10	12	2	12	14	3	10	12	2.5	-	-	-	-	-	14	16.5	4	4	
38	190	5	7	1.2	10	12	2.5	10	12	2.5	10	12	2.5	10	12	2	12	14	3	12	14	3	-	-	-	-	-	14	16.5	4	4	
40	200	6	8	1.5	10	12	2.5	10	12	2.5	12	14	3	12	14	3	12	14	3	12	14	3	-	-	-	-	-	14	16.5	4	4	
44	220	6	8	1.5	10	12	2.5	10	12	2.5	12	14	3	12	14	3	12	14	3	12	14	3	-	-	-	-	-	14	16.5	4	4	
48	240	6	8	1.5	10	12	2.5	10	12	2.5	12	14	3	12	14	3	14	16.5	4	14	16.5	4	-	-	-	-	-	14	16.5	4	4	
52	260	10	12	2.5	12	14	3	12	14	3	12	14	3	12	14	3	14	16.5	4	14	16.5	4	-	-	-	-	-	14	16.5	4	4	
56	280	10	12	2.5	12	14	3	12	14	3	12	14	3	12	14	3	14	16.5	4	14	16.5	4	-	-	-	-	-	14	16.5	4	4	
60	300	10	12	2.5	12	14	3	12	14	3	12	14	3	12	14	3	14	16.5	4	14	16.5	4	-	-	-	-	-	14	16.5	4	4	
64	320	10	12	2.5	12	14	3	12	14	3	14	16.5	4	14	16.5	4	14	16.5	4	14	16.5	4	-	-	-	-	-	14	16.5	4	4	
68	340	12	14	3	14	16.5	4	14	16.5	4	14	16.5	4	14	16.5	4	14	16.5	4	14	16.5	4	-	-	-	-	-	14	16.5	4	4	
72	360	12	14	3	14	16.5	4	14	16.5	4	14	16.5	4	14	16.5	4	14	16.5	4	14	16.5	4	-	-	-	-	-	14	16.5	4	4	

Table 4 (2) Lubrication hole and lubrication groove dimensions Unit : mm

Bore diameter number	Nominal bore diameter <i>d</i>	239			230			240			231			241			222			232			213			223					
		<i>d</i> ₀	<i>w</i>	<i>h</i>	<i>d</i> ₀	<i>w</i>	<i>h</i>	<i>d</i> ₀	<i>w</i>	<i>h</i>	<i>d</i> ₀	<i>w</i>	<i>h</i>	<i>d</i> ₀	<i>w</i>	<i>h</i>	<i>d</i> ₀	<i>w</i>	<i>h</i>	<i>d</i> ₀	<i>w</i>	<i>h</i>	<i>d</i> ₀	<i>w</i>	<i>h</i>	<i>d</i> ₀	<i>w</i>	<i>h</i>			
76	380	12	14	3	14	16.5	4	14	16.5	3	14	16.5	4	14	16.5	4	-	-	-	14	16.5	4	-	-	-	-	-	-	-	-	-
80	400	12	14	3	14	16.5	4	14	16.5	4	14	16.5	4	14	16.5	4	-	-	-	14	16.5	4	-	-	-	-	-	-	-	-	-
84	420	12	14	3	14	16.5	4	14	16.5	4	14	16.5	4	14	16.5	4	-	-	-	14	16.5	4	-	-	-	-	-	-	-	-	-
88	440	14	16.5	4	14	16.5	4	14	16.5	4	14	16.5	4	14	16.5	4	-	-	-	14	16.5	4	-	-	-	-	-	-	-	-	-
92	460	14	16.5	4	14	16.5	4	14	16.5	4	14	16.5	4	14	16.5	4	-	-	-	14	16.5	4	-	-	-	-	-	-	-	-	-
96	480	14	16.5	4	14	16.5	4	14	16.5	4	14	16.5	4	14	16.5	4	-	-	-	14	16.5	4	-	-	-	-	-	-	-	-	-
/500	500	14	16.5	4	14	16.5	4	14	16.5	4	14	16.5	4	14	16.5	5	-	-	-	14	16.5	4	-	-	-	-	-	-	-	-	-

Boundary dimensions	As specified in JIS B 1512.
Tolerances	As specified in JIS B 1514-1, class 0. (refer to Table 7-3 on pp. A 54 – A 57.) Refer to Table 7-11 on p. A 70 for the tolerance of tapered bores.
Radial internal clearance	As specified in JIS B 1520. (refer to Table 10-9 on p. A 102.)
Recommended fits	Refer to Table 9-4 on pp. A 85, 86.
Standard cages	Refer to Table 5.
Allowable aligning angle	Refer to Table 5. (varies depending on bearing series.)
Equivalent radial load	Dynamic equivalent radial load $\left(\text{When } \frac{F_a}{F_r} \leq e \right) P_r = F_r + Y_1 F_a \quad \left(\text{When } \frac{F_a}{F_r} > e \right) P_r = 0.67 F_r + Y_2 F_a$ Static equivalent radial load $P_{0r} = F_r + Y_0 F_a$ [Note] Refer to the specification table for the values of axial load factors Y_1, Y_2 and Y_0 and of constant e .

[Remark] If the ratio of axial load to radial load exceeds the value e given in the specification table ($F_a/F_r > e$), slippage occurs between rollers in rows that are not axial-loaded and the raceway. This may cause smearing, especially when the bearing is large. Consult with JTEKT on the use of bearings under such conditions.

Table 5 Application of standard cages and allowable aligning angle

Bearing series	Standard cages		Allowable aligning angle
	Pressed cage	Machined cage	
239 R	-	23930R – 239/500R	0.026 rad (1.5°)
230 R	-	23038R – 230/500R	0.026 rad (1.5°)
RH	23022RH – 23036RH	-	
RHA	-	23038RHA – 23096RHA	
240 R(RR)	-	24036R – 240/500R	0.035 rad (2°)
RH	24024RH – 24034RH	-	
RHA	-	24038RHA – 24096RHA	
231 R	-	23136R – 231/500R	0.026 rad (1.5°)
RH	23122RH – 23134RH	-	
RHA	-	23136RHA – 23196RHA	
241 R(RR)	-	24132R – 241/500R	0.044 rad (2.5°)
RH	24122RH – 24130RH	-	
RHA	-	24136RHA – 24196RHA	
222 R(RR)	-	22232RR – 222/500R	0.026 rad (1.5°)
RH(RHR)	22205RHR – 22230RH	-	
RHA	-	22232RHA – 22260RHA	
232 R	-	23232R – 232/500R	0.044 rad (2.5°)
RH	23218RH – 23230RH	-	

Spherical roller bearings

d 25 ~ 70 mm

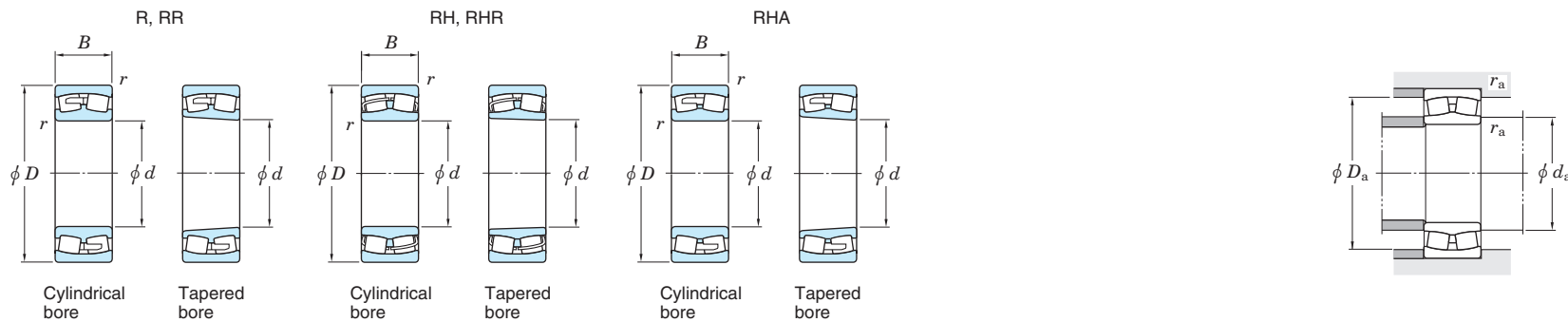

Boundary dimensions (mm)				Basic load ratings (kN)		Limiting speeds (min ⁻¹)		Bearing No.		Mounting dimensions (mm)			Constant	Axial load factors			(Refer.) Mass (kg)	
d	D	B	r _{min.}	C _r	C _{0r}	Grease lub.	Oil lub.	Cylindrical bore	Tapered bore	d _a min.	D _a max.	r _a max.	e	Y ₁	Y ₂	Y ₀	Cylindrical bore	Tapered bore
25	52	18	1	45.4	48.1	7 000	9 300	22205RHR	22205RHRK	31	46	1	0.35	1.91	2.85	1.87	0.188	0.184
	62	20	1	61.2	65.9	5 900	7 900	22206RHR	22206RHRK	36	56	1	0.33	2.04	3.04	2.00	0.296	0.290
30	72	19	1.1	59.3	62.7	5 200	7 000	21306RH	21306RHK	37	65	1	0.27	2.49	3.71	2.43	0.430	0.424
	72	23	1.1	80.3	88.7	5 000	6 700	22207RHR	22207RHRK	42	65	1	0.32	2.09	3.11	2.04	0.459	0.449
35	80	21	1.5	69.6	75.3	4 500	6 000	21307RH	21307RHK	43.5	71.5	1.5	0.27	2.49	3.71	2.43	0.572	0.564
	80	23	1.1	90.9	102	4 500	6 000	22208RHR	22208RHRK	47	73	1	0.28	2.37	3.53	2.32	0.602	0.591
40	90	23	1.5	85.7	95.5	4 100	5 500	21308RH	21308RHK	48.5	81.5	1.5	0.26	2.55	3.80	2.50	0.781	0.770
	90	33	1.5	136	152	4 100	5 500	22308RHR	22308RHRK	48.5	81.5	1.5	0.37	1.83	2.72	1.79	1.08	1.06
	85	23	1.1	95.6	110	4 200	5 600	22209RHR	22209RHRK	52	78	1	0.26	2.55	3.80	2.50	0.602	0.590
45	100	25	1.5	108	124	3 600	4 900	21309RH	21309RHK	53.5	91.5	1.5	0.26	2.62	3.90	2.56	1.05	1.04
	100	36	1.5	166	183	3 700	4 900	22309RHR	22309RHRK	53.5	91.5	1.5	0.37	1.83	2.72	1.79	1.42	1.39
	90	23	1.1	103	122	3 900	5 200	22210RHR	22210RHRK	57	83	1	0.24	2.79	4.15	2.73	0.648	0.634
50	110	27	2	128	151	3 300	4 400	21310RH	21310RHK	60	100	2	0.25	2.71	4.04	2.65	1.37	1.35
	110	40	2	204	237	3 300	4 500	22310RHR	22310RHRK	60	100	2	0.36	1.85	2.76	1.81	1.92	1.88
	100	25	1.5	124	144	3 400	4 600	22211RHR	22211RHRK	63.5	91.5	1.5	0.24	2.84	4.23	2.78	0.867	0.849
55	120	29	2	144	165	3 000	4 100	21311RH	21311RHK	65	110	2	0.25	2.71	4.03	2.65	1.69	1.67
	120	43	2	236	264	3 000	4 000	22311RHR	22311RHRK	65	110	2	0.36	1.85	2.76	1.81	2.40	2.35
	110	28	1.5	153	181	3 100	4 200	22212RHR	22212RHRK	68.5	101.5	1.5	0.25	2.74	4.08	2.68	1.19	1.17
60	130	31	2.1	168	193	2 800	3 700	21312RH	21312RHK	72	118	2	0.24	2.78	4.14	2.72	2.11	2.08
	130	46	2.1	283	334	2 800	3 700	22312RHR	22312RHRK	72	118	2	0.36	1.86	2.77	1.82	3.06	2.99
	120	31	1.5	178	211	2 900	3 800	22213RHR	22213RHRK	73.5	111.5	1.5	0.25	2.69	4.00	2.63	1.55	1.52
65	140	33	2.1	194	232	2 600	3 400	21313RH	21313RHK	77	128	2	0.24	2.83	4.21	2.76	2.62	2.58
	140	48	2.1	305	360	2 600	3 400	22313RHR	22313RHRK	77	128	2	0.34	1.98	2.94	1.93	3.66	3.58
	125	31	1.5	187	222	2 700	3 600	22214RHR	22214RHRK	78.5	116.5	1.5	0.24	2.87	4.27	2.80	1.64	1.61
70	150	35	2.1	215	260	2 400	3 200	21314RH	21314RHK	82	138	2	0.24	2.84	4.23	2.78	3.19	3.15
	150	51	2.1	348	413	2 400	3 200	22314RHR	22314RHRK	82	138	2	0.34	1.98	2.94	1.93	4.45	4.36

[Remark] Standard cage types used for the above bearings are shown in Table 5 earlier in this section.

Spherical roller bearings

d 75 ~ (110) mm

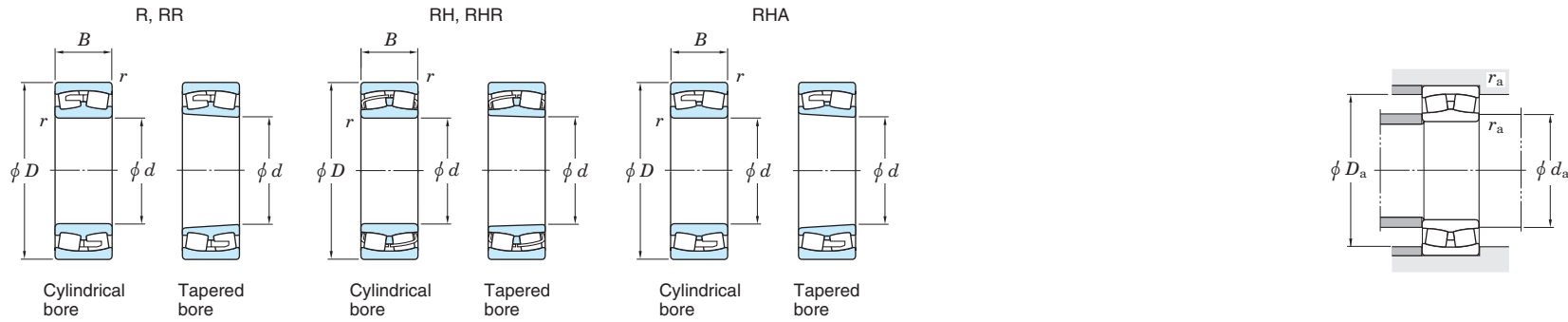

Boundary dimensions (mm)				Basic load ratings (kN)		Limiting speeds (min ⁻¹)		Bearing No.		Mounting dimensions (mm)			Constant e	Axial load factors			(Refer.) Mass (kg)	
d	D	B	r _{min.}	C _r	C _{0r}	Grease lub.	Oil lub.	Cylindrical bore	Tapered bore	d _{a min.}	D _{a max.}	r _{a max.}		Y ₁	Y ₂	Y ₀	Cylindrical bore	Tapered bore
75	130	31	1.5	193	236	2 600	3 400	22215RHR	22215RHRK	83.5	121.5	1.5	0.22	3.07	4.57	3.00	1.73	1.69
	160	37	2.1	246	298	2 200	3 000	21315RH	21315RHK	87	148	2	0.24	2.87	4.27	2.80	3.81	3.76
	160	55	2.1	393	473	2 200	3 000	22315RHR	22315RHRK	87	148	2	0.35	1.95	2.90	1.91	5.45	5.33
80	140	33	2	217	271	2 400	3 200	22216RHR	22216RHRK	90	130	2	0.22	3.07	4.57	3.00	2.17	2.13
	170	39	2.1	275	339	2 100	2 800	21316RH	21316RHK	92	158	2	0.23	2.88	4.29	2.82	4.53	4.47
	170	58	2.1	431	521	2 100	2 800	22316RHR	22316RHRK	92	158	2	0.35	1.95	2.90	1.91	6.44	6.30
85	150	36	2	258	324	2 200	3 000	22217RHR	22217RHRK	95	140	2	0.22	3.01	4.48	2.94	2.75	2.69
	180	41	3	300	372	2 000	2 600	21317RH	21317RHK	99	166	2.5	0.23	2.89	4.33	2.83	5.32	5.25
	180	60	3	481	586	2 000	2 600	22317RHR	22317RHRK	99	166	2.5	0.33	2.02	3.00	1.97	7.47	7.31
90	160	40	2	298	381	2 100	2 800	22218RHR	22218RHRK	100	150	2	0.24	2.79	4.15	2.73	3.50	3.43
	160	52.4	2	336	482	2 100	2 800	23218RH	23218RHK	100	150	2	0.32	2.14	3.19	2.09	4.63	4.50
	190	43	3	330	416	1 900	2 500	21318RH	21318RHK	104	176	2.5	0.23	2.91	4.30	2.84	6.20	6.11
	190	64	3	538	662	1 900	2 500	22318RHR	22318RHRK	104	176	2.5	0.34	2.00	2.98	1.96	8.82	8.63
95	170	43	2.1	334	422	2 000	2 600	22219RHR	22219RHRK	107	158	2	0.24	2.76	4.11	2.70	4.24	4.15
	200	45	3	362	461	1 800	2 300	21319RH	21319RHK	109	186	2.5	0.23	2.92	4.35	2.86	7.16	7.06
	200	67	3	586	726	1 800	2 300	22319RHR	22319RHRK	109	186	2.5	0.33	2.02	3.00	1.97	10.2	9.98
100	150	37	1.5	208	332	2 100	2 800	23020RH	23020RHK	117	141	1.5	0.22	3.01	4.48	2.94	2.34	2.27
	180	46	2.1	377	481	1 900	2 500	22220RHR	22220RHRK	112	168	2	0.25	2.74	4.08	2.68	5.11	5.00
	180	60.3	2.1	425	629	1 900	2 500	23220RH	23220RHK	112	168	2	0.32	2.09	3.11	2.04	6.85	6.66
	215	47	3	416	524	1 600	2 200	21320RH	21320RHK	114	201	2.5	0.22	3.02	4.49	2.95	8.79	8.68
	215	73	3	700	877	1 600	2 200	22320RHR	22320RHRK	114	201	2.5	0.35	1.95	2.90	1.91	13.2	12.9
110	170	45	2	300	486	1 900	2 500	23022RH	23022RHK	120	160	2	0.24	2.84	4.23	2.78	3.85	3.74
	180	56	2	385	605	1 800	2 400	23122RH	23122RHK	120	170	2	0.29	2.36	3.51	2.31	5.72	5.54
	180	69	2	469	778	1 800	2 400	24122RH	24122RHK30	120	170	2	0.37	1.84	2.74	1.80	6.98	6.87
	200	53	2.1	491	642	1 700	2 200	22222RHR	22222RHRK	122	188	2	0.26	2.64	3.93	2.58	7.37	7.21
	200	69.8	2.1	537	792	1 700	2 200	23222RH	23222RHK	122	188	2	0.34	1.99	2.96	1.94	9.76	9.48
	240	50	3	484	616	1 400	1 900	21322RH	21322RHK	124	226	2.5	0.21	3.19	4.75	3.12	11.8	11.7

[Remark] Standard cage types used for the above bearings are shown in Table 5 earlier in this section.

Spherical roller bearings

d (110) ~ (150) mm

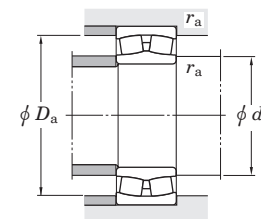
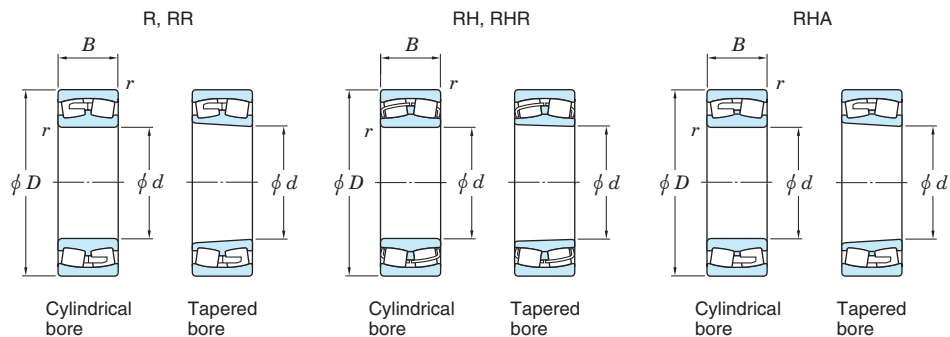

Boundary dimensions (mm)				Basic load ratings (kN)		Limiting speeds (min ⁻¹)		Bearing No.		Mounting dimensions (mm)			Constant e	Axial load factors			(Refer.) Mass (kg)	
d	D	B	$r_{min.}$	C_r	C_{0r}	Grease lub.	Oil lub.	Cylindrical bore	Tapered bore	d_a min.	D_a max.	r_a max.		Y_1	Y_2	Y_0	Cylindrical bore	Tapered bore
110	240	80	3	828	1 040	1 400	1 900	22322RHR	22322RHRK	124	226	2.5	0.33	2.03	3.02	1.98	18.1	17.7
120	180	46	2	314	524	1 700	2 300	23024RH	23024RHK	130	170	2	0.23	2.95	4.40	2.89	4.20	4.07
	180	60	2	397	709	1 700	2 300	24024RH	24024RHK30	130	170	2	0.30	2.23	3.32	2.18	5.43	5.34
	200	62	2	454	714	1 600	2 200	23124RH	23124RHK	130	190	2	0.29	2.34	3.49	2.29	7.98	7.74
	200	80	2	605	1 020	1 600	2 200	24124RH	24124RHK30	130	190	2	0.38	1.75	2.61	1.72	10.2	10.0
	215	58	2.1	565	764	1 500	2 000	22224RHR	22224RHRK	132	203	2	0.26	2.60	3.87	2.54	9.31	9.10
	215	76	2.1	616	956	1 500	2 100	23224RH	23224RHK	132	203	2	0.34	1.97	2.94	1.93	12.2	11.8
	260	86	3	896	1 130	1 300	1 800	22324RHR	22324RHRK	134	246	2.5	0.33	2.03	3.02	1.98	22.8	22.3
130	200	52	2	404	674	1 600	2 100	23026RH	23026RHK	140	190	2	0.24	2.87	4.27	2.80	6.15	5.97
	200	69	2	512	914	1 600	2 100	24026RH	24026RHK30	140	190	2	0.32	2.14	3.18	2.09	8.03	7.90
	210	64	2	494	799	1 500	2 000	23126RH	23126RHK	140	200	2	0.28	2.42	3.61	2.37	8.71	8.44
	210	80	2	620	1 080	1 500	2 000	24126RH	24126RHK30	140	200	2	0.36	1.90	2.83	1.86	10.8	10.6
	230	64	3	658	914	1 400	1 900	22226RHR	22226RHRK	144	216	2.5	0.26	2.55	3.80	2.50	11.6	11.3
	230	80	3	702	1 090	1 400	1 900	23226RH	23226RHK	144	216	2.5	0.33	2.05	3.05	2.00	14.4	14.0
	280	93	4	1 040	1 340	1 200	1 600	22326RHR	22326RHRK	148	262	3	0.33	2.03	3.02	1.98	28.5	27.9
140	210	53	2	422	723	1 500	2 000	23028RH	23028RHK	150	200	2	0.23	2.98	4.44	2.92	6.62	6.42
	210	69	2	524	957	1 500	2 000	24028RH	24028RHK30	150	200	2	0.30	2.28	3.39	2.23	8.49	8.35
	225	68	2.1	565	940	1 400	1 900	23128RH	23128RHK	152	213	2	0.28	2.45	3.65	2.40	10.6	10.3
	225	85	2.1	702	1 220	1 400	1 900	24128RH	24128RHK30	152	213	2	0.36	1.89	2.82	1.85	13.1	12.9
	250	68	3	759	1 030	1 300	1 700	22228RHR	22228RHRK	154	236	2.5	0.26	2.60	3.87	2.54	14.5	14.2
	250	88	3	811	1 290	1 300	1 700	23228RH	23228RHK	154	236	2.5	0.34	1.99	2.96	1.95	19.0	18.4
	300	102	4	1 170	1 570	1 100	1 500	22328RH	22328RHK	158	282	3	0.35	1.95	2.90	1.90	35.7	34.9
150	210	45	2	334	622	1 600	2 100	23930R	23930RK	160	200	2	0.20	3.44	5.12	3.36	5.09	4.93
	225	56	2.1	461	797	1 400	1 800	23030RH	23030RHK	162	213	2	0.22	3.04	4.53	2.97	8.01	7.77
	225	75	2.1	593	1 100	1 400	1 800	24030RH	24030RHK30	162	213	2	0.30	2.23	3.32	2.18	10.6	10.4
	250	80	2.1	717	1 230	1 300	1 700	23130RH	23130RHK	162	238	2	0.30	2.24	3.34	2.19	16.4	15.9
	250	100	2.1	915	1 590	1 300	1 700	24130RH	24130RHK30	162	238	2	0.38	1.77	2.64	1.73	19.9	19.6

[Remark] Standard cage types used for the above bearings are shown in Table 5 earlier in this section.

Spherical roller bearings

d (150) ~ (180) mm

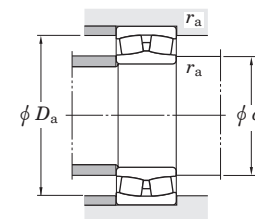
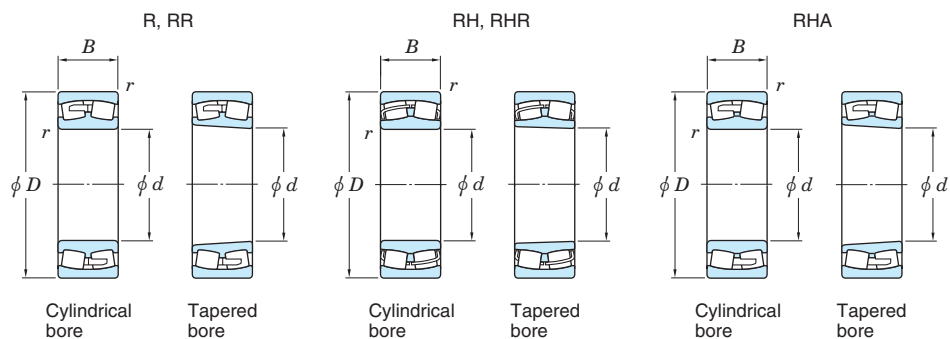

Boundary dimensions (mm)	Basic load ratings (kN)		Limiting speeds (min ⁻¹)		Bearing No.		Mounting dimensions (mm)			Constant e	Axial load factors			(Refer.) Mass (kg)		
							d _a min.	D _a max.	r _a max.		Y ₁	Y ₂	Y ₀	Cylindrical bore	Tapered bore	
d	D	B	r _{min.}	C _r	C _{0r}	Grease lub.	Oil lub.	Cylindrical bore	Tapered bore							
150	270	73	3	865	1 200	1 200	1 600	22230RHR	22230RHRK	0.25	2.69	4.00	2.63	18.9	18.5	
	270	96	3	959	1 540	1 200	1 600	23230RH	23230RHK	0.34	1.96	2.93	1.92	24.5	23.8	
	320	108	4	1 230	1 600	1 200	1 500	22330R	22330RK	0.38	1.78	2.64	1.74	43.6	42.7	
	320	108	4	1 290	1 740	1 200	1 500	22330RHA	22330RHAK	0.35	1.93	2.87	1.88	40.3	39.4	
160	220	45	2	341	649	1 500	2 000	23932R	23932RK	0.19	3.60	5.37	3.52	5.37	5.20	
	240	60	2.1	531	924	1 300	1 700	23032RH	23032RHK	0.22	3.01	4.48	2.94	9.74	9.44	
	240	80	2.1	679	1 270	1 300	1 700	24032RH	24032RHK30	0.30	2.24	3.34	2.19	12.9	12.7	
	270	86	2.1	848	1 430	1 200	1 600	23132RH	23132RHK	0.30	2.22	3.30	2.17	20.8	20.2	
	290	80	3	885	1 270	1 200	1 600	22232R	22232RK	0.28	2.40	3.57	2.35	23.4	22.9	
	290	80	3	897	1 320	1 200	1 600	22232RHA	22232RHAK	0.27	2.49	3.71	2.44	21.9	21.4	
	290	104	3	1 030	1 650	1 200	1 600	23232R	23232RK	0.38	1.79	2.66	1.75	31.0	30.1	
	290	104	3	1 100	1 780	1 200	1 600	23232RHA	23232RHAK	0.36	1.87	2.78	1.83	29.4	28.5	
	340	114	4	1 380	1 790	1 100	1 400	22332R	22332RK	0.38	1.76	2.62	1.72	51.9	51.0	
	340	114	4	1 420	1 940	1 100	1 400	22332RHA	22332RHAK	0.35	1.94	2.89	1.90	48.0	47.1	
170	230	45	2	353	691	1 400	1 900	23934R	23934RK	0.18	3.78	5.63	3.70	5.67	5.49	
	260	67	2.1	632	1 090	1 200	1 600	23034RH	23034RHK	0.23	2.90	4.31	2.83	13.2	12.8	
	260	90	2.1	828	1 540	1 200	1 600	24034RH	24034RHK30	0.32	2.11	3.15	2.07	17.5	17.2	
	280	88	2.1	916	1 550	1 100	1 500	23134RH	23134RHK	0.29	2.30	3.43	2.25	21.9	21.2	
	280	109	2.1	1 050	1 820	1 600	1 200	24134RR	24134RRK30	0.37	1.80	2.68	1.76	27.2	26.8	
	310	86	4	952	1 390	1 100	1 500	22234R	22234RK	0.29	2.29	3.41	2.24	29.0	28.4	
	310	86	4	1 010	1 490	1 100	1 500	22234RHA	22234RHAK	0.28	2.45	3.64	2.39	27.1	26.5	
	310	110	4	1 150	1 870	1 100	1 500	23234R	23234RK	0.37	1.81	2.70	1.77	37.5	36.5	
	310	110	4	1 210	1 940	1 100	1 500	23234RHA	23234RHAK	0.36	1.89	2.82	1.85	35.6	34.6	
	360	120	4	1 460	1 920	1 000	1 300	22334R	22334RK	0.38	1.77	2.64	1.73	62.0	60.8	
360	120	4	1 590	2 200	1 000	1 300	22334RHA	22334RHAK	0.35	1.95	2.91	1.91	57.3	56.1		
180	250	52	2	479	939	1 300	1 700	23936R	23936RK	0.19	3.55	5.29	3.48	8.22	7.97	
	280	74	2.1	768	1 330	1 100	1 400	23036RH	23036RHK	0.24	2.84	4.23	2.78	17.4	16.9	

[Remark] Standard cage types used for the above bearings are shown in Table 5 earlier in this section.

Spherical roller bearings

d (180) ~ (200) mm

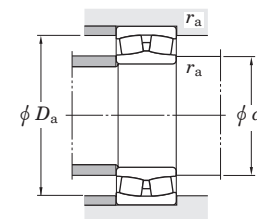
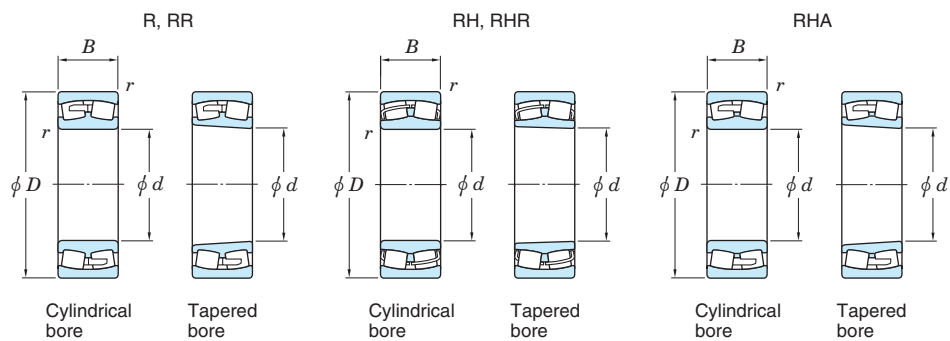

Boundary dimensions (mm)				Basic load ratings (kN)		Limiting speeds (min ⁻¹)		Bearing No.		Mounting dimensions (mm)			Constant e	Axial load factors			(Refer.) Mass (kg)		
d	D	B	r _{min.}	C _r	C _{0r}	Grease lub.	Oil lub.	Cylindrical bore	Tapered bore	d _a min.	D _a max.	r _a max.		Y ₁	Y ₂	Y ₀	Cylindrical bore	Tapered bore	
180	280	100	2.1	933	1 710	1 600	1 200	24036RR	24036RRK30	192	268	2	0.34	2.00	2.98	1.96	23.4	23.0	
	300	96	3	1 000	1 800	1 100	1 500	23136R	23136RK	194	286	2.5	0.33	2.04	3.04	2.00	28.4	27.5	
	300	96	3	1 060	1 790	1 100	1 500	23136RHA	23136RHAK	194	286	2.5	0.31	2.19	3.25	2.14	26.5	25.6	
	300	118	3	1 220	2 120	1 100	1 500	24136RR	24136RRK30	194	286	2.5	0.38	1.78	2.65	1.74	34.4	33.9	
	300	118	3	1 250	2 240	1 100	1 500	24136RHA	24136RHAK30	194	286	2.5	0.38	1.79	2.66	1.75	31.8	31.2	
	320	86	4	978	1 450	1 100	1 400	22236R	22236RK	198	302	3	0.28	2.37	3.53	2.32	30.5	29.8	
	320	86	4	1 060	1 610	1 100	1 400	22236RHA	22236RHAK	198	302	3	0.26	2.55	3.80	2.50	28.5	27.8	
	320	112	4	1 190	1 980	1 100	1 400	23236R	23236RK	198	302	3	0.37	1.84	2.74	1.80	39.8	38.6	
	320	112	4	1 320	2 170	1 100	1 400	23236RHA	23236RHAK	198	302	3	0.34	1.97	2.93	1.92	37.7	36.5	
	380	126	4	1 740	2 360	920	1 200	22336R	22336RK	198	362	3	0.36	1.89	2.81	1.84	71.4	69.9	
	380	126	4	1 740	2 410	930	1 200	22336RHA	22336RHAK	198	362	3	0.34	1.97	2.94	1.93	66.0	64.5	
	190	260	52	2	486	969	1 200	1 600	23938R	23938RK	200	250	2	0.18	3.69	5.50	3.61	8.40	8.10
290		75	2.1	736	1 370	1 100	1 500	23038R	23038RK	202	278	2	0.25	2.67	3.97	2.61	18.8	18.2	
290		75	2.1	789	1 430	1 100	1 500	23038RHA	23038RHAK	202	278	2	0.25	2.75	4.10	2.69	17.2	16.6	
290		100	2.1	989	1 840	1 100	1 500	24038RR	24038RRK30	202	278	2	0.33	2.06	3.07	2.02	24.5	24.1	
290		100	2.1	1 010	1 920	1 100	1 500	24038RHA	24038RHAK30	202	278	2	0.32	2.14	3.19	2.09	22.4	22.0	
320		104	3	1 090	2 000	1 000	1 400	23138R	23138RK	204	306	2.5	0.34	1.96	2.92	1.92	35.5	34.4	
320		104	3	1 210	2 080	1 000	1 400	23138RHA	23138RHAK	204	306	2.5	0.31	2.14	3.19	2.10	33.2	32.1	
320		128	3	1 400	2 470	1 000	1 400	24138RR	24138RRK30	204	306	2.5	0.39	1.74	2.59	1.70	43.0	42.4	
320		128	3	1 460	2 630	1 000	1 400	24138RHA	24138RHAK30	204	306	2.5	0.38	1.76	2.63	1.72	40.1	39.5	
340		92	4	1 110	1 730	1 000	1 300	22238R	22238RK	208	322	3	0.29	2.29	3.41	2.24	37.4	36.6	
340		92	4	1 150	1 770	1 000	1 300	22238RHA	22238RHAK	208	322	3	0.27	2.52	3.76	2.46	34.9	34.1	
340		120	4	1 410	2 210	1 000	1 300	23238R	23238RK	208	322	3	0.36	1.87	2.79	1.83	47.4	46.0	
340		120	4	1 490	2 470	990	1 300	23238RHA	23238RHAK	208	322	3	0.35	1.94	2.89	1.90	44.9	43.5	
400		132	5	1 900	2 610	880	1 200	22338R	22338RK	212	378	4	0.38	1.79	2.66	1.75	84.1	82.4	
400		132	5	1 940	2 810	870	1 200	22338RHA	22338RHAK	212	378	4	0.34	1.99	2.97	1.95	77.7	76.0	
200		280	60	2.1	601	1 190	1 100	1 500	23940R	23940RK	212	268	2	0.20	3.44	5.13	3.37	12.0	11.6
		310	82	2.1	890	1 670	1 000	1 400	23040R	23040RK	212	298	2	0.26	2.62	3.90	2.56	24.1	23.4
		310	82	2.1	940	1 680	1 100	1 400	23040RHA	23040RHAK	212	298	2	0.25	2.68	3.99	2.62	22.0	21.3

[Remark] Standard cage types used for the above bearings are shown in Table 5 earlier in this section.

Spherical roller bearings

d (200) ~ (240) mm

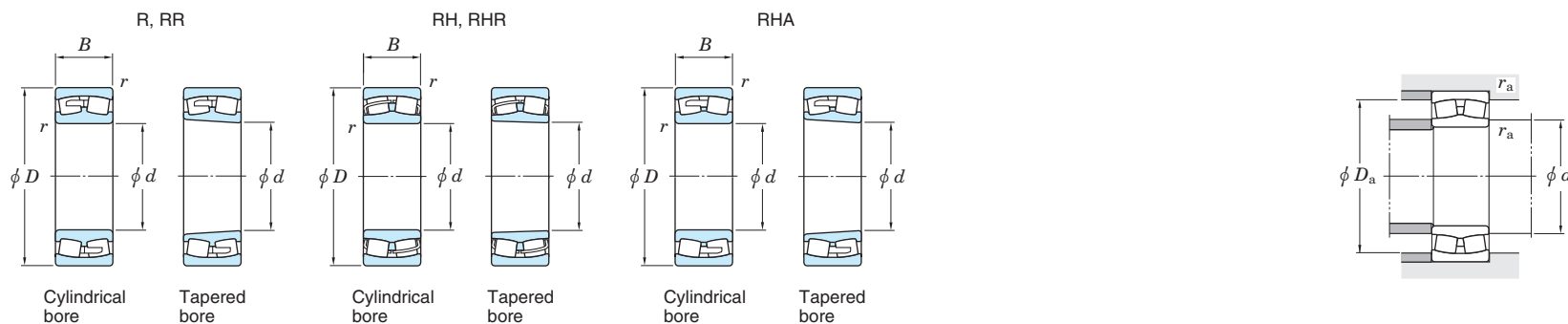

Boundary dimensions (mm)				Basic load ratings (kN)		Limiting speeds (min ⁻¹)		Bearing No.		Mounting dimensions (mm)			Constant e	Axial load factors			(Refer.) Mass (kg)	
d	D	B	r _{min.}	C _r	C _{0r}	Grease lub.	Oil lub.	Cylindrical bore	Tapered bore	d _a min.	D _a max.	r _a max.		Y ₁	Y ₂	Y ₀	Cylindrical bore	Tapered bore
200	310	109	2.1	1 140	2 110	1 100	1 400	24040RR	24040RRK30	212	298	2	0.33	2.02	3.00	1.97	31.2	30.7
	310	109	2.1	1 180	2 230	1 100	1 400	24040RHA	24040RHAK30	212	298	2	0.33	2.06	3.07	2.02	28.5	28.0
	340	112	3	1 240	2 250	980	1 300	23140R	23140RK	214	326	2.5	0.34	1.97	2.94	1.93	43.7	42.4
	340	112	3	1 380	2 340	970	1 300	23140RHA	23140RHAK	214	326	2.5	0.32	2.10	3.13	2.06	40.8	39.5
	340	140	3	1 620	2 820	990	1 300	24140RR	24140RRK30	214	326	2.5	0.40	1.68	2.49	1.64	53.3	52.5
	340	140	3	1 660	2 970	990	1 300	24140RHA	24140RHAK30	214	326	2.5	0.41	1.65	2.46	1.62	49.5	48.7
	360	98	4	1 230	1 930	930	1 200	22240R	22240RK	218	342	3	0.30	2.26	3.36	2.21	45.0	44.0
	360	98	4	1 310	2 030	940	1 300	22240RHA	22240RHAK	218	342	3	0.27	2.50	3.72	2.45	42.0	41.0
	360	128	4	1 550	2 610	940	1 300	23240R	23240RK	218	342	3	0.38	1.79	2.67	1.75	58.1	56.4
	360	128	4	1 660	2 780	930	1 200	23240RHA	23240RHAK	218	342	3	0.35	1.92	2.86	1.88	55.1	53.4
	420	138	5	2 010	2 750	830	1 100	22340R	22340RK	222	398	4	0.38	1.80	2.68	1.76	95.4	93.5
	420	138	5	2 060	2 920	820	1 100	22340RHA	22340RHAK	222	398	4	0.34	1.99	2.97	1.95	88.1	86.2
220	300	60	2.1	634	1 300	1 000	1 400	23944R	23944RK	232	288	2	0.18	3.70	5.50	3.61	13.0	12.6
	340	90	3	984	1 890	940	1 300	23044R	23044RK	234	326	2.5	0.26	2.55	3.80	2.50	31.5	30.6
	340	90	3	1 090	1 950	940	1 200	23044RHA	23044RHAK	234	326	2.5	0.25	2.69	4.01	2.63	28.8	27.9
	340	118	3	1 320	2 480	950	1 300	24044RR	24044RRK30	234	326	2.5	0.33	2.04	3.04	2.00	40.5	39.8
	340	118	3	1 380	2 630	950	1 300	24044RHA	24044RHAK30	234	326	2.5	0.33	2.08	3.09	2.03	37.0	36.4
	370	120	4	1 440	2 700	880	1 200	23144R	23144RK	238	352	3	0.34	2.00	2.98	1.96	54.8	53.2
	370	120	4	1 590	2 790	870	1 200	23144RHA	23144RHAK	238	352	3	0.31	2.15	3.20	2.10	51.2	49.6
	370	150	4	1 880	3 390	880	1 200	24144RR	24144RRK30	238	352	3	0.39	1.71	2.55	1.67	67.3	66.2
	370	150	4	1 920	3 550	880	1 200	24144RHA	24144RHAK30	238	352	3	0.40	1.69	2.52	1.65	62.0	61.0
	400	108	4	1 560	2 400	820	1 100	22244R	22244RK	238	382	3	0.28	2.40	3.57	2.34	63.0	61.7
	400	108	4	1 590	2 440	820	1 100	22244RHA	22244RHAK	238	382	3	0.27	2.52	3.76	2.47	58.8	57.5
	400	144	4	1 880	3 200	830	1 100	23244R	23244RK	238	382	3	0.39	1.71	2.55	1.68	81.6	79.2
	400	144	4	2 020	3 350	810	1 100	23244RHA	23244RHAK	238	382	3	0.36	1.89	2.81	1.85	77.4	75.0
	460	145	5	2 380	3 380	720	960	22344R	22344RK	242	438	4	0.34	2.00	2.99	1.96	124	122
	460	145	5	2 370	3 470	730	970	22344RHA	22344RHAK	242	438	4	0.32	2.08	3.09	2.03	115	113
240	320	60	2.1	651	1 380	940	1 300	23948R	23948RK	252	308	2	0.17	3.95	5.88	3.86	14.0	13.5

[Remark] Standard cage types used for the above bearings are shown in Table 5 earlier in this section.

Spherical roller bearings

d (240) ~ 260 mm

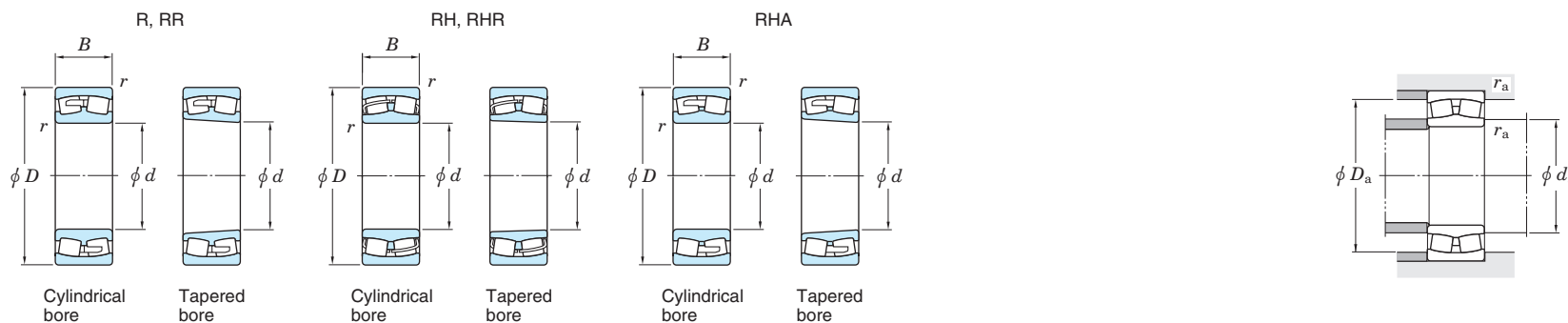

Boundary dimensions (mm)				Basic load ratings (kN)		Limiting speeds (min ⁻¹)		Bearing No.		Mounting dimensions (mm)			Constant e	Axial load factors			(Refer.) Mass (kg)	
d	D	B	$r_{min.}$	C_r	C_{0r}	Grease lub.	Oil lub.	Cylindrical bore	Tapered bore	d_a min.	D_a max.	r_a max.		Y_1	Y_2	Y_0	Cylindrical bore	Tapered bore
240	360	92	3	1 100	2 170	860	1 100	23048R	23048RK	254	346	2.5	0.25	2.71	4.04	2.65	34.9	33.8
	360	92	3	1 170	2 180	860	1 100	23048RHA	23048RHAK	254	346	2.5	0.24	2.83	4.21	2.77	31.9	30.9
	360	118	3	1 390	2 710	870	1 200	24048RR	24048RRK30	254	346	2.5	0.31	2.20	3.27	2.15	43.5	42.9
	360	118	3	1 430	2 840	870	1 200	24048RHA	24048RHAK30	254	346	2.5	0.30	2.24	3.33	2.19	39.6	39.0
	400	128	4	1 630	3 080	790	1 100	23148R	23148RK	258	382	3	0.33	2.05	3.05	2.00	67.6	65.6
	400	128	4	1 810	3 200	790	1 000	23148RHA	23148RHAK	258	382	3	0.31	2.19	3.25	2.14	63.1	61.1
	400	160	4	2 100	3 850	800	1 100	24148RR	24148RRK30	258	382	3	0.39	1.75	2.60	1.71	82.7	81.4
	400	160	4	2 200	4 130	800	1 100	24148RHA	24148RHAK30	258	382	3	0.39	1.72	2.56	1.68	76.6	75.3
	440	120	4	1 920	2 940	730	970	22248R	22248RK	258	422	3	0.29	2.35	3.50	2.30	85.0	83.2
	440	120	4	1 920	2 990	730	970	22248RHA	22248RHAK	258	422	3	0.27	2.49	3.71	2.43	79.4	77.6
	440	160	4	2 340	3 990	730	970	23248R	23248RK	258	422	3	0.39	1.73	2.57	1.69	110	107
	440	160	4	2 460	4 130	730	970	23248RHA	23248RHAK	258	422	3	0.36	1.87	2.78	1.83	104	101
	500	155	5	2 610	4 020	650	870	22348R	22348RK	262	478	4	0.35	1.94	2.89	1.90	157	154
	500	155	5	2 720	3 990	650	870	22348RHA	22348RHAK	262	478	4	0.32	2.12	3.16	2.07	145	142
260	360	75	2.1	914	1 880	820	1 100	23952R	23952RK	272	348	2	0.19	3.54	5.27	3.46	24.0	23.3
	400	104	4	1 330	2 570	760	1 000	23052R	23052RK	278	382	3	0.25	2.65	3.95	2.59	50.7	49.3
	400	104	4	1 470	2 720	760	1 000	23052RHA	23052RHAK	278	382	3	0.25	2.75	4.10	2.69	46.3	44.9
	400	140	4	1 810	3 570	770	1 000	24052RR	24052RRK30	278	382	3	0.33	2.02	3.01	1.98	66.3	65.2
	400	140	4	1 860	3 670	770	1 000	24052RHA	24052RHAK30	278	382	3	0.33	2.06	3.07	2.02	60.3	59.4
	440	144	4	2 100	3 860	710	940	23152R	23152RK	278	422	3	0.33	2.03	3.02	1.98	93.6	90.8
	440	144	4	2 220	4 000	700	930	23152RHA	23152RHAK	278	422	3	0.32	2.12	3.16	2.08	87.4	84.6
	440	180	4	2 590	4 700	720	950	24152RR	24152RRK30	278	422	3	0.40	1.69	2.51	1.65	114	112
	440	180	4	2 650	4 950	720	950	24152RHA	24152RHAK30	278	422	3	0.41	1.66	2.47	1.62	106	105
	480	130	5	2 240	3 460	650	870	22252R	22252RK	282	458	4	0.28	2.40	3.57	2.35	110	108
	480	130	5	2 230	3 430	650	870	22252RHA	22252RHAK	282	458	4	0.27	2.50	3.72	2.44	103	101
	480	174	5	2 750	4 640	640	860	23252R	23252RK	282	458	4	0.40	1.69	2.51	1.65	144	140
	480	174	5	2 870	4 900	650	860	23252RHA	23252RHAK	282	458	4	0.36	1.87	2.78	1.83	137	133
	540	165	6	2 830	4 380	590	780	22352R	22352RK	288	512	5	0.35	1.94	2.89	1.90	196	192
	540	165	6	3 120	4 620	580	780	22352RHA	22352RHAK	288	512	5	0.31	2.15	3.21	2.11	181	177

[Remark] Standard cage types used for the above bearings are shown in Table 5 earlier in this section.

Spherical roller bearings

d 280 ~ 300 mm

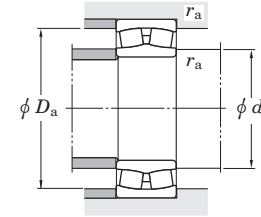
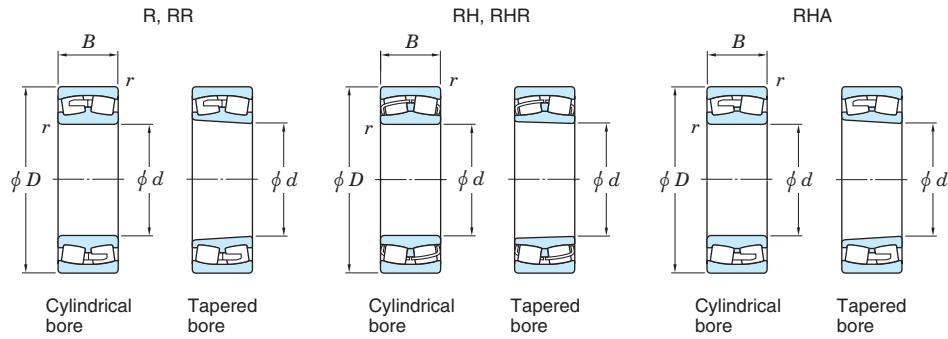

Boundary dimensions (mm)				Basic load ratings (kN)		Limiting speeds (min ⁻¹)		Bearing No.		Mounting dimensions (mm)			Constant	Axial load factors			(Refer.) Mass (kg)	
d	D	B	r _{min.}	C _r	C _{0r}	Grease lub.	Oil lub.	Cylindrical bore	Tapered bore	d _a min.	D _a max.	r _a max.	e	Y ₁	Y ₂	Y ₀	Cylindrical bore	Tapered bore
280	380	75	2.1	928	1 960	760	1 000	23956R	23956RK	292	368	2	0.18	3.74	5.57	3.66	26.0	25.2
	420	106	4	1 430	2 860	710	950	23056R	23056RK	298	402	3	0.25	2.74	4.08	2.68	54.5	52.9
	420	106	4	1 550	2 950	700	940	23056RHA	23056RHAK	298	402	3	0.24	2.87	4.27	2.80	49.8	48.2
	420	140	4	1 890	3 780	710	950	24056RR	24056RRK30	298	402	3	0.31	2.15	3.21	2.11	70.2	69.1
	420	140	4	1 960	4 000	710	950	24056RHA	24056RHAK30	298	402	3	0.31	2.20	3.28	2.15	64.0	62.9
	460	146	5	2 140	4 280	660	880	23156R	23156RK	302	438	4	0.33	2.04	3.03	1.99	100	96.9
	460	146	5	2 340	4 290	650	870	23156RHA	23156RHAK	302	438	4	0.30	2.22	3.30	2.17	93.4	90.3
	460	180	5	2 700	5 140	660	880	24156RR	24156RRK30	302	438	4	0.38	1.79	2.67	1.75	122	120
	460	180	5	2 740	5 240	660	880	24156RHA	24156RHAK30	302	438	4	0.38	1.76	2.62	1.72	113	112
	500	130	5	2 100	3 380	610	810	22256R	22256RK	302	478	4	0.28	2.42	3.60	2.37	114	112
	500	130	5	2 320	3 670	610	810	22256RHA	22256RHAK	302	478	4	0.26	2.64	3.93	2.58	106	104
	500	176	5	2 690	4 910	610	820	23256R	23256RK	302	478	4	0.37	1.83	2.72	1.79	153	149
	500	176	5	3 010	5 300	600	800	23256RHA	23256RHAK	302	478	4	0.35	1.95	2.91	1.91	145	141
	580	175	6	3 150	4 910	530	710	22356R	22356RK	308	552	5	0.34	1.98	2.95	1.93	229	225
	580	175	6	3 510	5 260	530	700	22356RHA	22356RHAK	308	552	5	0.31	2.19	3.25	2.14	212	208
	300	420	90	3	1 280	2 610	680	910	23960R	23960RK	314	406	2.5	0.20	3.42	5.09	3.34	40.0
460		118	4	1 750	3 480	630	840	23060R	23060RK	318	442	3	0.25	2.69	4.00	2.63	75.8	73.7
460		118	4	1 940	3 700	630	840	23060RHA	23060RHAK	318	442	3	0.24	2.79	4.16	2.73	68.9	66.8
460		160	4	2 350	4 690	640	850	24060RR	24060RRK30	318	442	3	0.33	2.04	3.04	2.00	99.5	97.9
460		160	4	2 420	4 910	640	850	24060RHA	24060RHAK30	318	442	3	0.32	2.09	3.11	2.04	90.7	89.1
500		160	5	2 490	4 850	590	790	23160R	23160RK	322	478	4	0.33	2.02	3.01	1.98	132	128
500		160	5	2 730	4 970	580	780	23160RHA	23160RHAK	322	478	4	0.31	2.18	3.25	2.13	123	119
500		200	5	3 320	6 280	590	790	24160RR	24160RRK30	322	478	4	0.40	1.67	2.49	1.63	162	160
500		200	5	3 320	6 420	590	790	24160RHA	24160RHAK30	322	478	4	0.39	1.72	2.56	1.68	150	148
540		140	5	2 690	4 330	550	740	22260R	22260RK	322	518	4	0.27	2.48	3.69	2.43	145	142
540		140	5	2 650	4 360	550	740	22260RHA	22260RHAK	322	518	4	0.26	2.62	3.90	2.56	135	132
540		192	5	3 430	5 910	540	720	23260R	23260RK	322	518	4	0.37	1.83	2.72	1.79	197	192
540		192	5	3 540	6 310	540	720	23260RHA	23260RHAK	322	518	4	0.35	1.93	2.88	1.89	187	182
620		185	7.5	3 910	5 430	470	630	22360R	22360RK	336	584	6	0.32	2.09	3.10	2.04	289	284

[Remark] Standard cage types used for the above bearings are shown in Table 5 earlier in this section.

Spherical roller bearings

d 320 ~ (360) mm

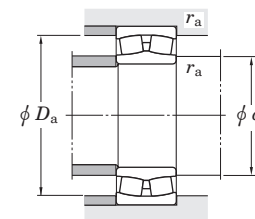
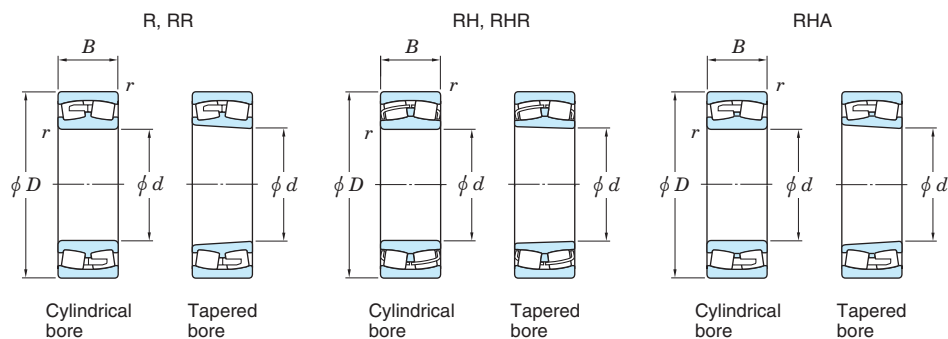

Boundary dimensions (mm)	Basic load ratings (kN)		Limiting speeds (min ⁻¹)		Bearing No.		Mounting dimensions (mm)			Constant	Axial load factors			Mass (kg)			
							d _a min.	D _a max.	r _a max.		e	Y ₁	Y ₂	Y ₀	Cylindrical bore	Tapered bore	
d	D	B	r _{min.}	C _r	C _{0r}	Grease lub.	Oil lub.	Cylindrical bore	Tapered bore								
320	440	90	3	1 330	2 870	630	840	23964R	23964RK		0.19	3.61	5.38	3.53	43.0	41.7	
	480	121	4	1 830	3 740	590	790	23064R	23064RK		0.24	2.76	4.11	2.70	81.2	78.8	
	480	121	4	1 980	3 850	590	780	23064RHA	23064RHAK		0.24	2.87	4.27	2.80	74.5	72.1	
	480	160	4	2 400	4 920	590	790	24064RR	24064RRK30		0.31	2.16	3.22	2.11	105	103	
	480	160	4	2 510	5 230	590	790	24064RHA	24064RHAK30		0.31	2.21	3.29	2.16	93.4	91.4	
	540	176	5	2 900	5 700	530	700	23164R	23164RK		0.33	2.04	3.04	2.00	171	166	
	540	176	5	3 220	5 960	530	700	23164RHA	23164RHAK		0.32	2.13	3.17	2.08	160	155	
	540	218	5	3 730	6 950	530	710	24164RR	24164RRK30		0.39	1.72	2.56	1.68	208	205	
	540	218	5	3 760	7 190	530	710	24164RHA	24164RHAK30		0.40	1.70	2.52	1.66	199	196	
	580	150	5	2 730	4 540	490	660	22264R	22264RK		0.28	2.41	3.59	2.35	175	171	
	580	208	5	3 630	6 550	500	670	23264R	23264RK		0.38	1.76	2.62	1.72	249	242	
	580	208	5	4 010	7 030	490	650	23264RHA	23264RHAK		0.36	1.90	2.83	1.86	236	229	
	340	460	90	3	1 350	2 980	590	790	23968R	23968RK		0.18	3.82	5.69	3.74	45.0	43.6
520		133	5	2 130	4 330	530	710	23068R	23068RK		0.25	2.69	4.00	2.63	108	105	
520		133	5	2 330	4 470	530	710	23068RHA	23068RHAK		0.24	2.80	4.18	2.74	98.7	95.7	
520		180	5	2 920	5 970	530	710	24068RR	24068RRK30		0.33	2.06	3.06	2.01	142	140	
520		180	5	3 040	6 330	530	710	24068RHA	24068RHAK30		0.32	2.11	3.14	2.06	130	128	
580		190	5	3 280	6 430	480	640	23168R	23168RK		0.34	1.97	2.93	1.93	216	210	
580		190	5	3 680	6 720	480	640	23168RHA	23168RHAK		0.32	2.11	3.14	2.06	202	196	
580		243	5	4 440	8 400	490	650	24168RR	24168RRK30		0.41	1.64	2.45	1.61	270	266	
580		243	5	4 540	8 810	490	650	24168RHA	24168RHAK30		0.42	1.61	2.39	1.57	259	255	
620		165	6	3 550	5 430	440	590	22268R	22268RK		0.28	2.43	3.61	2.37	221	216	
620		224	6	4 090	7 560	450	600	23268R	23268RK		0.38	1.77	2.63	1.73	306	297	
620		224	6	4 550	8 030	440	590	23268RHA	23268RHAK		0.36	1.88	2.81	1.84	290	281	
360		480	90	3	1 360	3 060	550	730	23972R	23972RK		0.17	3.95	5.88	3.86	46.5	45.0
		540	134	5	2 280	4 800	500	660	23072R	23072RK		0.24	2.76	4.11	2.70	115	111
	540	134	5	2 420	4 770	500	660	23072RHA	23072RHAK		0.23	2.92	4.34	2.85	105	101	
	540	180	5	3 030	6 300	500	660	24072RR	24072RRK30		0.31	2.15	3.21	2.11	149	147	
	540	180	5	3 120	6 620	500	660	24072RHA	24072RHAK30		0.30	2.22	3.30	2.17	135	133	

[Remark] Standard cage types used for the above bearings are shown in Table 5 earlier in this section.

Spherical roller bearings

d (360) ~ (400) mm

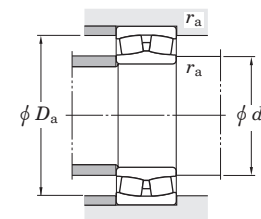
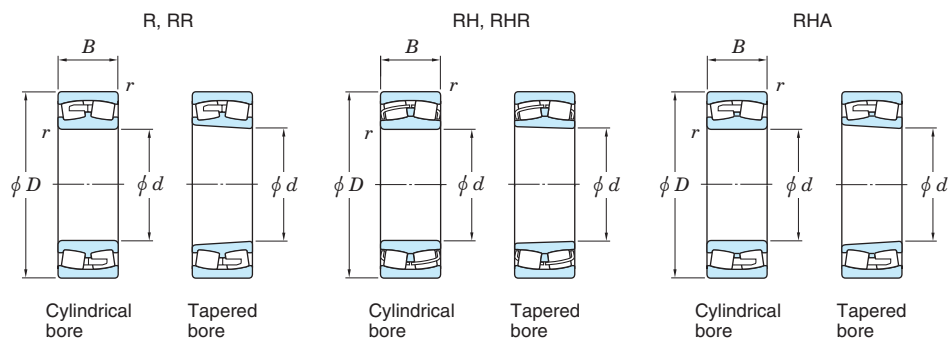

Boundary dimensions (mm)				Basic load ratings (kN)		Limiting speeds (min ⁻¹)		Bearing No.		Mounting dimensions (mm)			Constant e	Axial load factors			(Refer.) Mass (kg)	
d	D	B	r _{min.}	C _r	C _{0r}	Grease lub.	Oil lub.	Cylindrical bore	Tapered bore	d _a min.	D _a max.	r _a max.		Y ₁	Y ₂	Y ₀	Cylindrical bore	Tapered bore
360	600	192	5	3 770	7 040	440	590	23172R	23172RK	382	578	4	0.33	2.07	3.09	2.03	228	221
	600	192	5	3 850	7 210	450	590	23172RHA	23172RHAK	382	578	4	0.31	2.19	3.25	2.14	213	206
	600	243	5	4 080	7 690	450	600	24172R	24172RK30	382	578	4	0.39	1.74	2.59	1.70	287	283
	600	243	5	4 600	9 180	460	610	24172RHA	24172RHAK30	382	578	4	0.40	1.69	2.51	1.65	274	270
	650	170	6	3 770	5 830	410	550	22272R	22272RK	388	622	5	0.27	2.47	3.68	2.42	248	243
	650	232	6	4 850	8 810	410	540	23272R	23272RK	388	622	5	0.37	1.83	2.72	1.79	346	336
	650	232	6	4 960	9 050	410	550	23272RHA	23272RHAK	388	622	5	0.35	1.92	2.85	1.87	328	318
	380	520	106	4	1 780	3 940	500	660	23976R	23976RK	398	502	3	0.19	3.62	5.39	3.54	70.0
560		135	5	2 320	4 970	470	630	23076R	23076RK	402	538	4	0.24	2.79	4.16	2.73	122	118
560		135	5	2 520	5 080	460	620	23076RHA	23076RHAK	402	538	4	0.22	3.03	4.51	2.96	112	108
560		180	5	3 110	6 590	470	620	24076RR	24076RRK30	402	538	4	0.30	2.26	3.36	2.21	156	154
560		180	5	3 190	6 910	470	620	24076RHA	24076RHAK30	402	538	4	0.29	2.32	3.45	2.27	142	139
620		194	5	3 590	7 320	420	560	23176R	23176RK	402	598	4	0.31	2.18	3.24	2.13	240	233
620		194	5	4 000	7 700	420	560	23176RHA	23176RHAK	402	598	4	0.30	2.26	3.36	2.21	224	217
620		243	5	4 220	8 220	430	570	24176R	24176RK30	402	598	4	0.38	1.78	2.65	1.74	302	297
620		243	5	4 830	9 840	420	560	24176RHA	24176RHAK30	402	598	4	0.38	1.78	2.65	1.74	288	283
680		240	6	5 200	9 500	380	500	23276R	23276RK	408	652	5	0.36	1.85	2.76	1.81	386	375
680		240	6	5 320	9 760	380	510	23276RHA	23276RHAK	408	652	5	0.35	1.94	2.89	1.90	365	354
400		540	106	4	1 880	4 300	470	620	23980R	23980RK	418	522	3	0.18	3.76	5.59	3.67	73.0
	600	148	5	2 710	5 790	420	560	23080R	23080RK	422	578	4	0.24	2.84	4.23	2.78	155	151
	600	148	5	2 930	5 860	420	560	23080RHA	23080RHAK	422	578	4	0.23	2.94	4.37	2.87	142	138
	600	200	5	3 830	8 110	430	570	24080R	24080RK30	422	578	4	0.32	2.09	3.12	2.05	206	203
	600	200	5	3 780	8 140	420	570	24080RHA	24080RHAK30	422	578	4	0.31	2.21	3.29	2.16	192	189
	650	200	6	4 110	7 780	390	520	23180R	23180RK	428	622	5	0.31	2.19	3.25	2.14	273	265
	650	200	6	4 310	8 300	390	520	23180RHA	23180RHAK	428	622	5	0.29	2.30	3.43	2.25	255	247
	650	250	6	4 640	9 140	390	530	24180R	24180RK30	428	622	5	0.37	1.82	2.70	1.78	338	333
	650	250	6	5 180	10 600	390	520	24180RHA	24180RHAK30	428	622	5	0.37	1.82	2.71	1.78	322	317
	720	256	6	5 210	9 850	350	470	23280R	23280RK	428	692	5	0.37	1.80	2.69	1.76	468	454

[Remark] Standard cage types used for the above bearings are shown in Table 5 earlier in this section.

Spherical roller bearings

d (400) ~ (460) mm

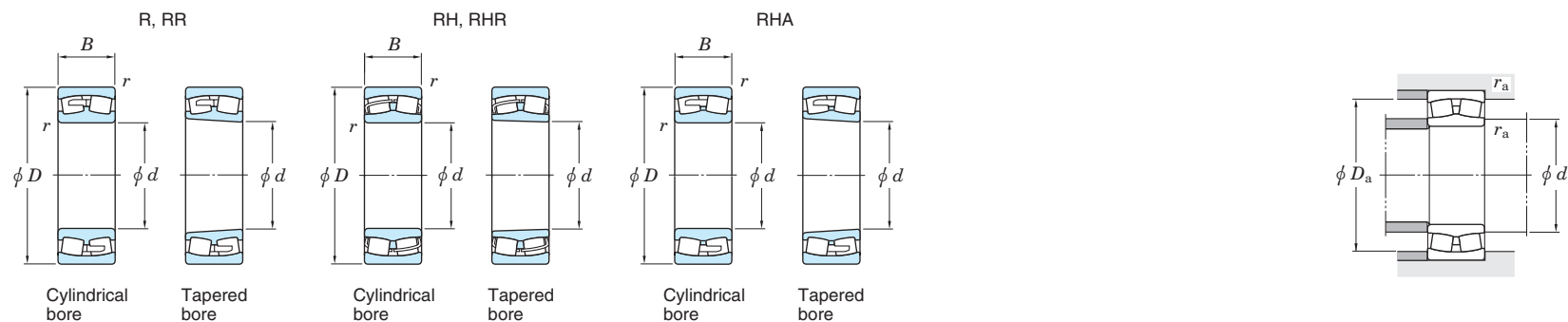

Boundary dimensions (mm)				Basic load ratings (kN)		Limiting speeds (min ⁻¹)		Bearing No.		Mounting dimensions (mm)			Constant	Axial load factors			(Refer.) Mass (kg)	
d	D	B	r _{min.}	C _r	C _{0r}	Grease lub.	Oil lub.	Cylindrical bore	Tapered bore	d _a min.	D _a max.	r _a max.	e	Y ₁	Y ₂	Y ₀	Cylindrical bore	Tapered bore
400	720	256	6	5 850	10 600	350	460	23280RHA	23280RHAK	428	692	5	0.35	1.92	2.86	1.88	441	427
420	560	106	4	1 880	4 320	430	580	23984R	23984RK	438	542	3	0.17	3.91	5.82	3.82	76.0	73.6
	620	150	5	2 800	6 120	400	530	23084R	23084RK	442	598	4	0.23	2.90	4.31	2.83	164	159
	620	150	5	3 050	6 230	400	530	23084RHA	23084RHAK	442	598	4	0.22	3.02	4.49	2.95	150	145
	620	200	5	3 590	7 600	400	530	24084R	24084RK30	442	598	4	0.30	2.23	3.32	2.18	212	209
	620	200	5	3 870	8 490	400	530	24084RHA	24084RHAK30	442	598	4	0.29	2.31	3.44	2.26	198	195
	700	224	6	4 470	9 110	350	470	23184R	23184RK	448	672	5	0.33	2.03	3.02	1.98	363	352
	700	224	6	5 040	9 630	350	470	23184RHA	23184RHAK	448	672	5	0.31	2.19	3.25	2.14	339	328
	700	280	6	5 450	10 600	360	480	24184R	24184RK30	448	672	5	0.40	1.71	2.54	1.67	445	438
	700	280	6	6 120	12 400	350	470	24184RHA	24184RHAK30	448	672	5	0.39	1.72	2.56	1.68	425	418
	760	272	7.5	6 500	11 500	320	430	23284R	23284RK	456	724	6	0.37	1.84	2.74	1.80	556	540
	760	272	7.5	6 580	11 900	320	430	23284RHA	23284RHAK	456	724	6	0.36	1.90	2.83	1.86	525	508
440	600	118	4	2 330	5 330	400	530	23988R	23988RK	458	582	3	0.18	3.75	5.58	3.66	101	97.8
	650	157	6	3 030	6 540	370	500	23088R	23088RK	468	622	5	0.24	2.76	4.11	2.70	188	183
	650	157	6	3 370	6 910	370	490	23088RHA	23088RHAK	468	622	5	0.22	3.04	4.53	2.97	172	167
	650	212	6	3 910	8 320	370	490	24088R	24088RK30	468	622	5	0.29	2.35	3.50	2.30	247	243
	650	212	6	4 330	9 560	370	490	24088RHA	24088RHAK30	468	622	5	0.30	2.28	3.39	2.23	231	227
	720	226	6	5 040	9 600	330	440	23188R	23188RK	468	692	5	0.33	2.08	3.09	2.03	378	366
	720	226	6	5 250	10 300	330	440	23188RHA	23188RHAK	468	692	5	0.30	2.25	3.34	2.20	353	341
	720	280	6	5 640	11 200	340	450	24188R	24188RK30	468	692	5	0.38	1.76	2.62	1.72	460	453
	720	280	6	6 200	12 900	330	440	24188RHA	24188RHAK30	468	692	5	0.38	1.79	2.67	1.75	439	432
	790	280	7.5	6 860	12 300	300	400	23288R	23288RK	476	754	6	0.36	1.86	2.77	1.82	613	595
	790	280	7.5	6 930	12 700	300	390	23288RHA	23288RHAK	476	754	6	0.35	1.93	2.88	1.89	580	562
460	620	118	4	2 330	5 350	370	500	23992R	23992RK	478	602	3	0.17	3.89	5.79	3.80	107	104
	680	163	6	3 240	7 170	340	460	23092R	23092RK	488	652	5	0.23	2.92	4.34	2.85	215	209
	680	163	6	3 600	7 430	340	460	23092RHA	23092RHAK	488	652	5	0.22	3.04	4.53	2.97	197	191
	680	218	6	4 570	10 100	340	460	24092R	24092RK30	488	652	5	0.30	2.23	3.32	2.18	277	272

[Remark] Standard cage types used for the above bearings are shown in Table 5 earlier in this section.

Spherical roller bearings

d (460) ~ 500 mm

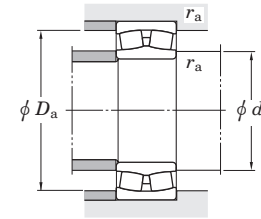
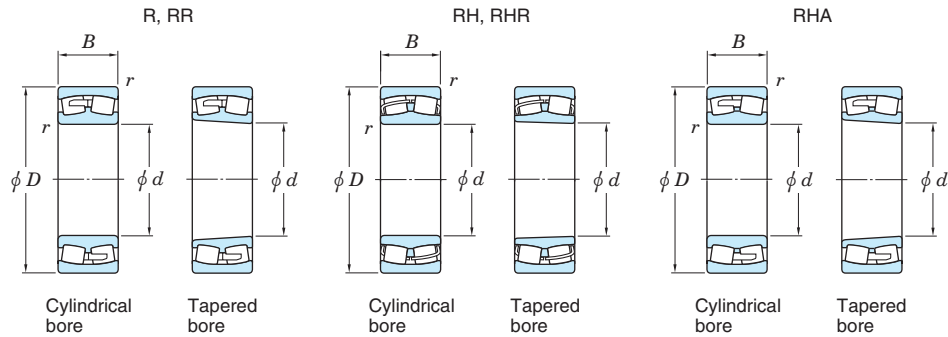

Boundary dimensions (mm)				Basic load ratings (kN)		Limiting speeds (min ⁻¹)		Bearing No.		Mounting dimensions (mm)			Constant e	Axial load factors			(Refer.) Mass (kg)	
d	D	B	r min.	C _r	C _{0r}	Grease lub.	Oil lub.	Cylindrical bore	Tapered bore	d _a min.	D _a max.	r _a max.		Y ₁	Y ₂	Y ₀	Cylindrical bore	Tapered bore
460	680	218	6	4 640	10 300	340	460	24092RHA	24092RHAK30	488	652	5	0.29	2.33	3.46	2.27	259	254
	760	240	7.5	5 180	10 800	310	410	23192R	23192RK	496	724	6	0.33	2.07	3.09	2.03	450	436
	760	240	7.5	5 760	11 200	300	400	23192RHA	23192RHAK	496	724	6	0.30	2.22	3.31	2.17	420	406
	760	300	7.5	6 040	12 200	310	410	24192R	24192RK30	496	724	6	0.35	1.95	2.90	1.91	550	541
	760	300	7.5	6 920	14 200	310	410	24192RHA	24192RHAK30	496	724	6	0.38	1.75	2.61	1.72	525	516
	830	296	7.5	7 610	13 700	270	370	23292R	23292RK	496	794	6	0.36	1.85	2.76	1.81	720	699
	830	296	7.5	7 670	14 200	270	360	23292RHA	23292RHAK	496	794	6	0.35	1.92	2.85	1.87	679	658
	480	650	128	5	2 630	6 130	350	460	23996R	23996RK	502	628	4	0.18	3.75	5.59	3.67	123
700		165	6	3 350	7 540	320	430	23096R	23096RK	508	672	5	0.22	3.01	4.47	2.94	225	218
700		165	6	3 730	7 860	320	430	23096RHA	23096RHAK	508	672	5	0.22	3.12	4.64	3.05	206	199
700		218	6	4 420	9 650	320	430	24096R	24096RK30	508	672	5	0.29	2.32	3.45	2.26	287	282
700		218	6	4 750	10 700	320	430	24096RHA	24096RHAK30	508	672	5	0.28	2.41	3.59	2.35	268	263
790		248	7.5	5 440	11 500	280	380	23196R	23196RK	516	754	6	0.32	2.09	3.12	2.05	503	488
790		248	7.5	6 160	12 000	280	380	23196RHA	23196RHAK	516	754	6	0.30	2.24	3.34	2.19	470	455
790		308	7.5	7 190	14 800	280	380	24196R	24196RK30	516	754	6	0.39	1.74	2.59	1.70	606	597
790		308	7.5	7 360	15 200	290	380	24196RHA	24196RHAK30	516	754	6	0.38	1.78	2.65	1.74	580	568
870		310	7.5	8 380	15 100	250	340	23296R	23296RK	516	834	6	0.36	1.85	2.75	1.81	831	807
870		310	7.5	8 450	15 700	250	340	23296RHA	23296RHAK	516	834	6	0.35	1.91	2.85	1.87	785	761
500	670	128	5	2 670	6 310	330	440	239/500R	239/500RK	522	648	4	0.17	3.87	5.76	3.79	131	127
	720	167	6	3 580	8 090	310	410	230/500R	230/500RK	528	692	5	0.23	2.94	4.37	2.87	235	228
	720	218	6	4 600	10 300	310	410	240/500R	240/500RK30	528	692	5	0.28	2.39	3.56	2.34	297	292
	830	264	7.5	6 160	13 000	260	350	231/500R	231/500RK	536	794	6	0.33	2.05	3.05	2.00	595	577
	830	325	7.5	7 710	15 900	260	350	241/500R	241/500RK30	536	794	6	0.36	1.85	2.76	1.81	712	701
	920	336	7.5	8 770	16 700	230	310	232/500R	232/500RK	536	884	6	0.39	1.74	2.59	1.70	1 020	992

[Remark] Standard cage types used for the above bearings are shown in Table 5 earlier in this section.

Adapter assemblies for spherical roller bearings

d_1 20 ~ 65 mm

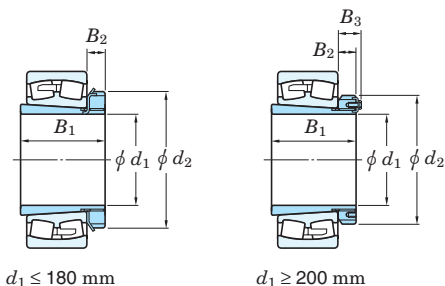

d_1 70 ~ 110 mm

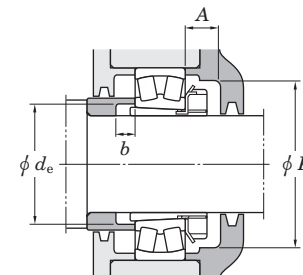

Boundary dimensions (mm)					Brg. bore d (mm)	Designations Bearing + adapter ass'y	Mounting dimensions (mm)				Mass Brg.+adapter ass'y (kg)	(Refer.)	
d_1	B_1	d_2	B_2	B_3			A min.	K min.	d_e min.	b min.		Adapter sleeve No.	Locknut No.
20	29	38	8	—	25	22205RHRK+H305X	15	45	29	5	0.269	A305X	AN05
25	31	45	8	—	30	22206RHRK+H306X	15	50	34	5	0.404	A306X	AN06
	31	45	8	—	30	21306RHK+H306X	15	50	34	6	0.538	A306X	AN06
30	35	52	9	—	35	22207RHRK+H307X	17	58	39	5	0.610	A307X	AN07
	35	52	9	—	35	21307RHK+H307X	17	58	39	7	0.725	A307X	AN07
35	36	58	10	—	40	22208RHRK+H308X	17	65	44	5	0.793	A308X	AN08
	36	58	10	—	40	21308RHK+H308X	17	65	44	5	0.972	A308X	AN08
	46	58	10	—	40	22308RHRK+H2308X	17	65	45	5	1.30	A2308X	AN08
40	39	65	11	—	45	22209RHRK+H309X	17	72	49	8	0.855	A309X	AN09
	39	65	11	—	45	21309RHK+H309X	17	72	49	5	1.31	A309X	AN09
	50	65	11	—	45	22309RHRK+H2309X	17	72	50	5	1.70	A2309X	AN09
45	42	70	12	—	50	22210RHRK+H310X	19	76	54	10	0.953	A310X	AN10
	42	70	12	—	50	21310RHK+H310X	19	76	54	5	1.67	A310X	AN10
	55	70	12	—	50	22310RHRK+H2310X	19	76	56	5	2.26	A2310X	AN10
50	45	75	12	—	55	22211RHRK+H311X	19	85	60	11	1.22	A311X	AN11
	45	75	12	—	55	21311RHK+H311X	19	85	60	6	2.04	A311X	AN11
	59	75	12	—	55	22311RHRK+H2311X	19	85	61	6	2.80	A2311X	AN11
55	47	80	13	—	60	22212RHRK+H312X	20	90	65	9	1.59	A312X	AN12
	47	80	13	—	60	21312RHK+H312X	20	90	65	5	2.50	A312X	AN12
	62	80	13	—	60	22312RHRK+H2312X	20	90	66	5	3.50	A2312X	AN12
60	50	85	14	—	65	22213RHRK+H313X	21	96	70	8	2.01	A313X	AN13
	50	85	14	—	65	21313RHK+H313X	21	96	70	5	3.07	A313X	AN13
	65	85	14	—	65	22313RHRK+H2313X	21	96	72	5	4.17	A2313X	AN13
65	55	98	15	—	75	22215RHRK+H315X	23	110	80	12	2.58	A315X	AN15
	55	98	15	—	75	21315RHK+H315X	23	110	80	5	4.65	A315X	AN15
	73	98	15	—	75	22315RHRK+H2315X	23	110	82	5	6.44	A2315X	AN15

Boundary dimensions (mm)					Brg. bore d (mm)	Designations Bearing + adapter ass'y	Mounting dimensions (mm)				Mass Brg.+adapter ass'y (kg)	(Refer.)	
d_1	B_1	d_2	B_2	B_3			A min.	K min.	d_e min.	b min.		Adapter sleeve No.	Locknut No.
70	59	105	17	—	80	22216RHRK+H316X	25	120	86	12	3.22	A316X	AN16
	59	105	17	—	80	21316RHK+H316X	25	120	86	5	5.56	A316X	AN16
	78	105	17	—	80	22316RHRK+H2316X	25	120	87	5	7.64	A2316X	AN16
75	63	110	18	—	85	22217RHRK+H317X	27	128	91	12	3.93	A317X	AN17
	63	110	18	—	85	21317RHK+H317X	27	128	91	6	6.49	A317X	AN17
	82	110	18	—	85	22317RHRK+H2317X	27	128	94	6	8.83	A2317X	AN17
80	65	120	18	—	90	22218RHRK+H318X	28	139	96	10	4.88	A318X	AN18
	86	120	18	—	90	23218RHK+H2318X	28	139	99	18	6.20	A2318X	AN18
	65	120	18	—	90	21318RHK+H318X	28	139	96	6	7.56	A318X	AN18
	86	120	18	—	90	22318RHRK+H2318X	28	139	99	6	10.3	A2318X	AN18
85	68	125	19	—	95	22219RHRK+H319X	29	145	102	9	5.77	A319X	AN19
	68	125	19	—	95	21319RHK+H319X	29	145	102	7	8.68	A319X	AN19
	90	125	19	—	95	22319RHRK+H2319X	29	145	105	7	12.0	A2319X	AN19
90	71	130	20	—	100	22220RHRK+H320X	30	150	107	8	6.80	A320X	AN20
	97	130	20	—	100	23220RHK+H2320X	30	150	110	19	8.94	A2320X	AN20
	71	130	20	—	100	21320RHK+H320X	30	150	107	7	10.5	A320X	AN20
	97	130	20	—	100	22320RHRK+H2320X	30	150	110	7	15.2	A2320X	AN20
100	81	145	21	—	110	23122RHK+H3122X	32	170	117	7	7.91	A3122X	AN22
	77	145	21	—	110	22222RHRK+H3222X	32	170	117	6	9.50	A322X	AN22
	105	145	21	—	110	23222RHK+H2322X	32	170	121	17	12.4	A2322X	AN22
	77	145	21	—	110	21322RHK+H3222X	32	170	117	9	14.0	A322X	AN22
	105	145	21	—	110	22322RHRK+H2322X	32	170	121	7	20.6	A2322X	AN22
	77	145	21	—	110	21322RHK+H3222X	32	170	117	9	14.0	A322X	AN22
110	72	145	22	—	120	23024RHK+H3024X	33	180	127	7	6.12	A3024	ANL24
	88	155	22	—	120	23124RHK+H3124X	33	180	128	7	10.5	A3124	AN24
	88	155	22	—	120	22224RHRK+H3124X	33	180	128	11	11.9	A3124	AN24
	112	155	22	—	120	23224RHK+H2324X	33	180	131	17	15.1	A2324	AN24
	112	155	22	—	120	22324RHRK+H2324X	33	180	131	7	25.6	A2324	AN24
	112	155	22	—	120	21324RHK+H3124X	33	180	128	11	11.9	A3124	AN24

Adapter assemblies for spherical roller bearings

d_1 115 ~ (150) mm

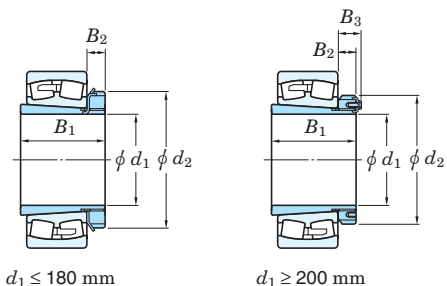

d_1 (150) ~ (180) mm

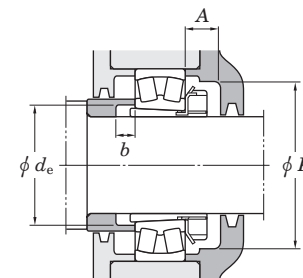

Boundary dimensions (mm)					Brg. bore d (mm)	Designations Bearing + adapter ass'y	Mounting dimensions (mm)				Mass Brg.+adapter ass'y (kg)	(Refer.)	
d_1	B_1	d_2	B_2	B_3			A min.	K min.	d_e min.	b min.		Adapter sleeve No.	Locknut No.
115	80	155	23	—	130	23026RHK+H3026	34	190	137	8	9.01	A3026	ANL26
	92	165	23	—	130	23126RHK+H3126	34	190	138	8	12.3	A3126	AN26
	92	165	23	—	130	22226RHRK+H3126	34	190	138	8	15.1	A3126	AN26
	121	165	23	—	130	23226RHK+H2326	34	190	142	21	18.8	A2326	AN26
	121	165	23	—	130	22326RHRK+H2326	34	190	142	8	32.7	A2326	AN26
	125	82	165	24	—	140	23028RHK+H3028	36	205	147	8	9.79	A3028
97		180	24	—	140	23128RHK+H3128	36	205	149	8	14.9	A3128	AN28
97		180	24	—	140	22228RHRK+H3128	36	205	149	8	18.8	A3128	AN28
131		180	24	—	140	23228RHK+H2328	36	205	152	22	24.3	A2328	AN28
131		180	24	—	140	22328RHK+H2328	36	205	152	8	40.8	A2328	AN28
135		87	180	26	—	150	23030RHK+H3030	37	220	158	8	11.9	A3030
	111	195	26	—	150	23130RHK+H3130	37	220	160	8	21.7	A3130	AN30
	111	195	26	—	150	22230RHRK+H3130	37	220	160	15	24.3	A3130	AN30
	139	195	26	—	150	23230RHK+H2330	37	220	163	20	30.8	A2330	AN30
	139	195	26	—	150	22330RK+H2330	37	220	163	8	49.7	A2330	AN30
	139	195	26	—	150	22330RHAK+H2330	37	220	163	8	46.4	A2330	AN30
140	93	190	28	—	160	23032RHK+H3032	39	230	168	8	15.0	A3032	ANL32
	119	210	28	—	160	23132RHK+H3132	39	230	170	8	27.9	A3132	AN32
	119	210	28	—	160	22232RK+H3132	39	230	170	14	30.6	A3132	AN32
	119	210	28	—	160	22232RHAK+H3132	39	230	170	14	29.1	A3132	AN32
	147	210	28	—	160	23232RK+H2332	39	230	174	18	39.6	A2332	AN32
	147	210	28	—	160	23232RHAK+H2332	39	230	174	18	38.0	A2332	AN32
	147	210	28	—	160	22332RK+H2332	39	230	174	8	60.5	A2332	AN32
	147	210	28	—	160	22332RHAK+H2332	39	230	174	8	56.6	A2332	AN32
	150	101	200	29	—	170	23034RHK+H3034	40	250	179	8	19.2	A3034
122		220	29	—	170	23134RHK+H3134	40	250	180	8	30.0	A3134	AN34
122		220	29	—	170	22234RK+H3134	40	250	180	10	37.2	A3134	AN34
122		220	29	—	170	22234RHAK+H3134	40	250	180	10	35.3	A3134	AN34

Boundary dimensions (mm)					Brg. bore d (mm)	Designations Bearing + adapter ass'y	Mounting dimensions (mm)				Mass Brg.+adapter ass'y (kg)	(Refer.)		
d_1	B_1	d_2	B_2	B_3			A min.	K min.	d_e min.	b min.		Adapter sleeve No.	Locknut No.	
150	154	220	29	—	170	23234RK+H2334	40	250	185	18	47.2	A2334	AN34	
	154	220	29	—	170	23234RHAK+H2334	40	250	185	18	45.3	A2334	AN34	
	154	220	29	—	170	22334RK+H2334	40	250	185	8	71.5	A2334	AN34	
	154	220	29	—	170	22334RHAK+H2334	40	250	185	8	66.8	A2334	AN34	
160	109	210	30	—	180	23036RHK+H3036	41	260	189	8	24.2	A3036	ANL36	
	131	230	30	—	180	23136RK+H3136	41	260	191	8	37.1	A3136	AN36	
	131	230	30	—	180	23136RHAK+H3136	41	260	191	8	35.2	A3136	AN36	
	131	230	30	—	180	22236RK+H3136	41	260	191	18	39.4	A3136	AN36	
	131	230	30	—	180	22236RHAK+H3136	41	260	191	18	37.4	A3136	AN36	
	161	230	30	—	180	23236RK+H2336	41	260	195	22	50.5	A2336	AN36	
	161	230	30	—	180	23236RHAK+H2336	41	260	195	22	48.4	A2336	AN36	
	161	230	30	—	180	22336RK+H2336	41	260	195	8	81.8	A2336	AN36	
	161	230	30	—	180	22336RHAK+H2336	41	260	195	8	76.4	A2336	AN36	
170	112	220	31	—	190	23038RK+H3038	43	270	199	9	26.1	A3038	ANL38	
	112	220	31	—	190	23038RHAK+H3038	43	270	199	9	24.5	A3038	ANL38	
	141	240	31	—	190	23138RK+H3138	43	270	202	9	45.3	A3138	AN38	
	141	240	31	—	190	23138RHAK+H3138	43	270	202	9	43.0	A3138	AN38	
	141	240	31	—	190	22238RK+H3138	43	270	202	21	47.5	A3138	AN38	
	141	240	31	—	190	22238RHAK+H3138	43	270	202	21	45.0	A3138	AN38	
	169	240	31	—	190	23238RK+H2338	43	270	206	21	59.2	A2338	AN38	
	169	240	31	—	190	23238RHAK+H2338	43	270	206	21	56.7	A2338	AN38	
	169	240	31	—	190	22338RK+H2338	43	270	206	9	95.6	A2338	AN38	
	169	240	31	—	190	22338RHAK+H2338	43	270	206	9	89.2	A2338	AN38	
	180	120	240	32	—	200	23040RK+H3040	46	280	210	10	32.8	A3040	ANL40
		120	240	32	—	200	23040RHAK+H3040	46	280	210	10	30.7	A3040	ANL40
150		250	32	—	200	23140RK+H3140	46	280	212	10	54.7	A3140	AN40	
150		250	32	—	200	23140RHAK+H3140	46	280	212	10	51.8	A3140	AN40	
150		250	32	—	200	22240RK+H3140	46	280	212	24	56.3	A3140	AN40	
150		250	32	—	200	22240RHAK+H3140	46	280	212	24	53.3	A3140	AN40	

Adapter assemblies for spherical roller bearings

d_1 (180) ~ (240) mm

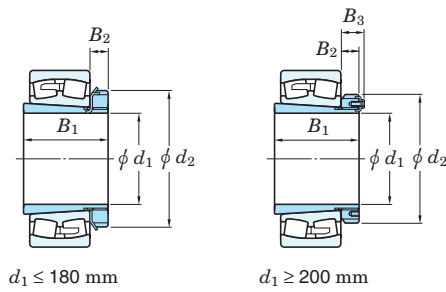

d_1 (240) ~ (300) mm

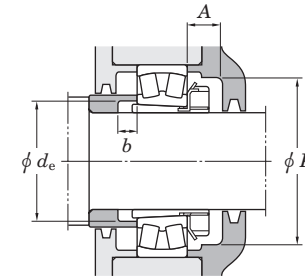

Boundary dimensions (mm)					Brg. bore d (mm)	Designations Bearing + adapter ass'y	Mounting dimensions (mm)				Mass Brg.+adapter ass'y (kg)	(Refer.)		
d_1	B_1	d_2	B_2	B_3			A min.	K min.	d_e min.	b min.		Adapter sleeve No.	Locknut No.	
180	176	250	32	—	200	23240RK+H2340	46	280	216	20	71.0	A2340	AN40	
	176	250	32	—	200	23240RHAK+H2340	46	280	216	20	68.0	A2340	AN40	
	176	250	32	—	200	22340RK+H2340	46	280	216	10	108	A2340	AN40	
	176	250	32	—	200	22340RHAK+H2340	46	280	216	10	101	A2340	AN40	
200	128	260	30	41	220	23044RK+H3044	—	—	231	12	41.4	A3044	ANL44	
	128	260	30	41	220	23044RHAK+H3044	—	—	231	12	38.7	A3044	ANL44	
	158	280	32	44	220	23144RK+H3144	—	—	233	10	68.4	A3144	AN44	
	158	280	32	44	220	23144RHAK+H3144	—	—	233	10	64.8	A3144	AN44	
	158	280	32	44	220	22244RK+H3144	—	—	233	22	76.9	A3144	AN44	
	158	280	32	44	220	22244RHAK+H3144	—	—	233	22	72.7	A3144	AN44	
	183	280	32	44	220	23244RK+H2344	—	—	236	11	96.5	A2344	AN44	
	183	280	32	44	220	23244RHAK+H2344	—	—	236	11	92.3	A2344	AN44	
	183	280	32	44	220	22344RK+H2344	—	—	236	10	139	A2344	AN44	
	183	280	32	44	220	22344RHAK+H2344	—	—	236	10	130	A2344	AN44	
	220	133	290	34	46	240	23048RK+H3048	—	—	251	11	47.7	A3048	ANL48
		133	290	34	46	240	23048RHAK+H3048	—	—	251	11	44.8	A3048	ANL48
		169	300	34	46	240	23148RK+H3148	—	—	254	11	83.6	A3148	AN48
		169	300	34	46	240	23148RHAK+H3148	—	—	254	11	79.1	A3148	AN48
169		300	34	46	240	22248RK+H3148	—	—	254	19	101	A3148	AN48	
169		300	34	46	240	22248RHAK+H3148	—	—	254	19	95.6	A3148	AN48	
196		300	34	46	240	23248RK+H2348	—	—	257	6	128	A2348	AN48	
196		300	34	46	240	23248RHAK+H2348	—	—	257	6	122	A2348	AN48	
196		300	34	46	240	22348RK+H2348	—	—	257	11	175	A2348	AN48	
196		300	34	46	240	22348RHAK+H2348	—	—	257	11	163	A2348	AN48	
240		147	310	34	46	260	23052RK+H3052	—	—	272	13	65.4	A3052	ANL52
		147	310	34	46	260	23052RHAK+H3052	—	—	272	13	61.0	A3052	ANL52
		187	330	36	49	260	23152RK+H3152	—	—	276	11	114	A3152	AN52
		187	330	36	49	260	23152RHAK+H3152	—	—	276	11	108	A3152	AN52

Boundary dimensions (mm)					Brg. bore d (mm)	Designations Bearing + adapter ass'y	Mounting dimensions (mm)				Mass Brg.+adapter ass'y (kg)	(Refer.)		
d_1	B_1	d_2	B_2	B_3			A min.	K min.	d_e min.	b min.		Adapter sleeve No.	Locknut No.	
240	187	330	36	49	260	22252RK+H3152	—	—	276	25	131	A3152	AN52	
	187	330	36	49	260	22252RHAK+H3152	—	—	276	25	124	A3152	AN52	
	208	330	36	49	260	23252RK+H2352	—	—	278	2	165	A2352	AN52	
	208	330	36	49	260	23252RHAK+H2352	—	—	278	2	158	A2352	AN52	
	208	330	36	49	260	22352RK+H2352	—	—	278	11	217	A2352	AN52	
	208	330	36	49	260	22352RHAK+H2352	—	—	278	11	202	A2352	AN52	
	260	152	330	38	50	280	23056RK+H3056	—	—	292	12	71.5	A3056	ANL56
152		330	38	50	280	23056RHAK+H3056	—	—	292	12	66.8	A3056	ANL56	
192		350	38	51	280	23156RK+H3156	—	—	296	12	123	A3156	AN56	
192		350	38	51	280	23156RHAK+H3156	—	—	296	12	116	A3156	AN56	
192		350	38	51	280	22256RK+H3156	—	—	296	28	138	A3156	AN56	
192		350	38	51	280	22256RHAK+H3156	—	—	296	28	130	A3156	AN56	
221		350	38	51	280	23256RK+H2356	—	—	299	11	178	A2356	AN56	
221		350	38	51	280	23256RHAK+H2356	—	—	299	11	170	A2356	AN56	
221		350	38	51	280	22356RK+H2356	—	—	299	12	254	A2356	AN56	
221		350	38	51	280	22356RHAK+H2356	—	—	299	12	237	A2356	AN56	
280		168	360	42	54	300	23060RK+H3060	—	—	313	12	97.7	A3060	ANL60
		168	360	42	54	300	23060RHAK+H3060	—	—	313	12	90.8	A3060	ANL60
		208	380	40	53	300	23160RK+H3160	—	—	317	12	159	A3160	AN60
	208	380	40	53	300	23160RHAK+H3160	—	—	317	12	150	A3160	AN60	
	208	380	40	53	300	22260RK+H3160	—	—	317	32	173	A3160	AN60	
	208	380	40	53	300	22260RHAK+H3160	—	—	317	32	163	A3160	AN60	
	240	380	40	53	300	23260RK+H3260	—	—	321	12	227	A3260	AN60	
	240	380	40	53	300	23260RHAK+H3260	—	—	321	12	217	A3260	AN60	
	300	171	380	42	55	320	23064RK+H3064	—	—	334	13	105	A3064	ANL64
		171	380	42	55	320	23064RHAK+H3064	—	—	334	13	98.1	A3064	ANL64
226		400	42	56	320	23164RK+H3164	—	—	339	13	202	A3164	AN64	
226		400	42	56	320	23164RHAK+H3164	—	—	339	13	191	A3164	AN64	
226		400	42	56	320	22264RK+H3164	—	—	339	39	207	A3164	AN64	

Adapter assemblies for spherical roller bearings

d_1 (300) ~ (400) mm

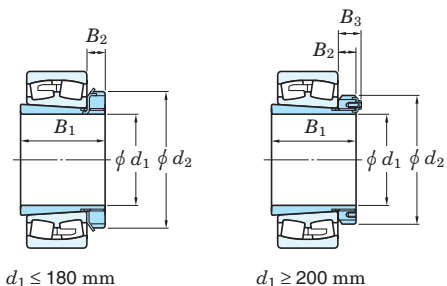

d_1 (400) ~ (470) mm

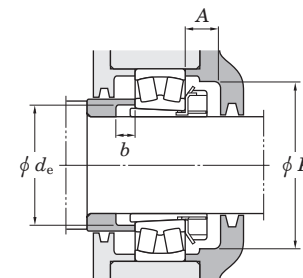

Boundary dimensions (mm)					Brg. bore d (mm)	Designations Bearing + adapter ass'y	Mounting dimensions (mm)				Mass Brg.+adapter ass'y (kg)	(Refer.)	
d_1	B_1	d_2	B_2	B_3			A min.	K min.	d_e min.	b min.		Adapter sleeve No.	Locknut No.
300	258	400	42	56	320	23264RK+H3264	—	—	343	13	283	A3264	AN64
	258	400	42	56	320	23264RHAK+H3264	—	—	343	13	270	A3264	AN64
320	187	400	45	58	340	23068RK+H3068	—	—	355	14	135	A3068	ANL68
	187	400	45	58	340	23068RHAK+H3068	—	—	355	14	126	A3068	ANL68
	254	440	55	72	340	23168RK+H3168	—	—	360	14	262	A3168	AN68
	254	440	55	72	340	23168RHAK+H3168	—	—	360	14	248	A3168	AN68
	288	440	55	72	340	23268RK+H3268	—	—	364	14	355	A3268	AN68
	288	440	55	72	340	23268RHAK+H3268	—	—	364	14	339	A3268	AN68
340	188	420	45	58	360	23072RK+H3072	—	—	375	14	143	A3072	ANL72
	188	420	45	58	360	23072RHAK+H3072	—	—	375	14	133	A3072	ANL72
	259	460	58	75	360	23172RK+H3172	—	—	380	14	278	A3172	AN72
	259	460	58	75	360	23172RHAK+H3172	—	—	380	14	263	A3172	AN72
	299	460	58	75	360	23272RK+H3272	—	—	385	14	400	A3272	AN72
	299	460	58	75	360	23272RHAK+H3272	—	—	385	14	382	A3272	AN72
360	193	450	48	62	380	23076RK+H3076	—	—	396	15	156	A3076	ANL76
	193	450	48	62	380	23076RHAK+H3076	—	—	396	15	146	A3076	ANL76
	264	490	60	77	380	23176RK+H3176	—	—	401	15	298	A3176	AN76
	264	490	60	77	380	23176RHAK+H3176	—	—	401	15	282	A3176	AN76
	310	490	60	77	380	23276RK+H3276	—	—	405	15	448	A3276	AN76
	310	490	60	77	380	23276RHAK+H3276	—	—	405	15	427	A3276	AN76
380	210	470	52	66	400	23080RK+H3080	—	—	417	15	195	A3080	ANL80
	210	470	52	66	400	23080RHAK+H3080	—	—	417	15	182	A3080	ANL80
	272	520	62	82	400	23180RK+H3180	—	—	421	15	339	A3180	AN80
	272	520	62	82	400	23180RHAK+H3180	—	—	421	15	321	A3180	AN80
	328	520	62	82	400	23280RK+H3280	—	—	427	15	539	A3280	AN80
	328	520	62	82	400	23280RHAK+H3280	—	—	427	15	512	A3280	AN80
	400	212	490	52	66	420	23084RK+H3084	—	—	437	16	205	A3084
212		490	52	66	420	23084RHAK+H3084	—	—	437	16	191	A3084	ANL84

Boundary dimensions (mm)					Brg. bore d (mm)	Designations Bearing + adapter ass'y	Mounting dimensions (mm)				Mass Brg.+adapter ass'y (kg)	(Refer.)	
d_1	B_1	d_2	B_2	B_3			A min.	K min.	d_e min.	b min.		Adapter sleeve No.	Locknut No.
400	304	540	70	90	420	23184RK+H3184	—	—	443	16	441	A3184	AN84
	304	540	70	90	420	23184RHA+H3184	—	—	443	16	417	A3184	AN84
	352	540	70	90	420	23284RK+H3284	—	—	448	16	639	A3284	AN84
	352	540	70	90	420	23284RHAK+H3284	—	—	448	16	607	A3284	AN84
410	228	520	60	77	440	23088RK+H3088	—	—	458	17	252	A3088	ANL88
	228	520	60	77	440	23088RHAK+H3088	—	—	458	17	236	A3088	ANL88
	307	560	70	90	440	23188RK+H3188	—	—	464	17	474	A3188	AN88
	307	560	70	90	440	23188RHAK+H3188	—	—	464	17	449	A3188	AN88
	361	560	70	90	440	23288RK+H3288	—	—	469	17	718	A3288	AN88
	361	560	70	90	440	23288RHAK+H3288	—	—	469	17	685	A3288	AN88
430	234	540	60	77	460	23092RK+H3092	—	—	478	17	283	A3092	ANL92
	234	540	60	77	460	23092RHAK+H3092	—	—	478	17	265	A3092	ANL92
	326	580	75	95	460	23192RK+H3192	—	—	485	17	559	A3192	AN92
	326	580	75	95	460	23192RHAK+H3192	—	—	485	17	529	A3192	AN92
	382	580	75	95	460	23292RK+H3292	—	—	491	17	838	A3292	AN92
	382	580	75	95	460	23292RHAK+H3292	—	—	491	17	797	A3292	AN92
450	237	560	60	77	480	23096RK+H3096	—	—	499	18	295	A3096	ANL96
	237	560	60	77	480	23096RHAK+H3096	—	—	499	18	276	A3096	ANL96
	335	620	75	95	480	23196RK+H3196	—	—	505	18	628	A3196	AN96
	335	620	75	95	480	23196RHAK+H3196	—	—	505	18	595	A3196	AN96
	397	620	75	95	480	23296RK+H3296	—	—	512	18	966	A3296	AN96
	397	620	75	95	480	23296RHAK+H3296	—	—	512	18	920	A3296	AN96
470	247	580	68	85	500	230/500RK+H30/500	—	—	519	18	315	A30/500	ANL100
	356	630	80	100	500	231/500RK+H31/500	—	—	527	18	727	A31/500	AN100
	428	630	80	100	500	232/500RK+H32/500	—	—	534	18	1 167	A32/500	AN100

Withdrawal sleeves for spherical roller bearings

d_1 35 ~ (75) mm

d_1 (75) ~ (115) mm

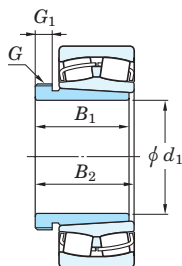

d_1	Boundary dimensions (mm)			G_1	Brg. bore d (mm)	Designations Bearing + withdrawal sleeve	Mass Brg.+withdrawal sleeve (kg)	(Refer.) Applicable locknut No.
	B_1	B_2	$G^{1)$ Screw size					
35	29	32	M45×1.5	6	40	22208RHRK+AH308	0.681	AN09
	29	32	M45×1.5	6	40	21308RHK+AH308	0.860	AN09
	40	43	M45×1.5	7	40	22308RHRK+AH2308	1.19	AN09
40	31	34	M50×1.5	6	45	22209RHRK+AH309	0.699	AN10
	31	34	M50×1.5	6	45	21309RHK+AH309	1.14	AN10
	44	47	M50×1.5	7	45	22309RHRK+AH2309	1.55	AN10
45	35	38	M55×2	7	50	22210RHRK+AHX310	0.771	AN11
	35	38	M55×2	7	50	21310RHK+AHX310	1.49	AN11
	50	53	M55×2	9	50	22310RHRK+AHX2310	2.09	AN11
50	37	40	M60×2	7	55	22211RHRK+AHX311	1.01	AN12
	37	40	M60×2	7	55	21311RHK+AHX311	1.83	AN12
	54	57	M60×2	10	55	22311RHRK+AHX2311	2.60	AN12
55	40	43	M65×2	8	60	22212RHRK+AHX312	1.35	AN13
	40	43	M65×2	8	60	21312RHK+AHX312	2.27	AN13
	58	61	M65×2	11	60	22312RHRK+AHX2312	3.29	AN13
60	42	45	M75×2	8	65	22213RHRK+AHX313	1.77	AN15
	42	45	M75×2	8	65	21313RHK+AHX313	2.84	AN15
	61	64	M75×2	12	65	22313RHRK+AHX2313	3.98	AN15
65	43	47	M80×2	8	70	22214RHRK+AHX314	1.89	AN16
	43	47	M80×2	8	70	21314RHK+AHX314	3.43	AN16
	64	68	M80×2	12	70	22314RHRK+AHX2314	4.82	AN16
70	45	49	M85×2	8	75	22215RHRK+AHX315	2.01	AN17
	45	49	M85×2	8	75	21315RHK+AHX315	4.07	AN17
	68	72	M85×2	12	75	22315RHRK+AHX2315	5.87	AN17
75	48	52	M90×2	8	80	22216RHRK+AHX316	2.49	AN18
	48	52	M90×2	8	80	21316RHK+AHX316	4.83	AN18

d_1	Boundary dimensions (mm)			G_1	Brg. bore d (mm)	Designations Bearing + withdrawal sleeve	Mass Brg.+withdrawal sleeve (kg)	(Refer.) Applicable locknut No.
	B_1	B_2	$G^{1)$ Screw size					
75	71	75	M90×2	12	80	22316RHRK+AHX2316	6.90	AN18
80	52	56	M95×2	9	85	22217RHRK+AHX317	3.12	AN19
	52	56	M95×2	9	85	21317RHK+AHX317	5.68	AN19
	74	78	M95×2	13	85	22317RHRK+AHX2317	7.98	AN19
85	53	57	M100×2	9	90	22218RHRK+AHX318	3.89	AN20
	63	67	M100×2	10	90	23218RHK+AHX3218	5.08	AN20
	53	57	M100×2	9	90	21318RHK+AHX318	6.58	AN20
90	79	83	M100×2	14	90	22318RHRK+AHX2318	9.41	AN20
	57	61	M105×2	10	95	22219RHRK+AHX319	4.68	AN21
95	57	61	M105×2	10	95	21319RHK+AHX319	7.59	AN21
	85	89	M105×2	16	95	22319RHRK+AHX2319	10.9	AN21
	59	63	M110×2	10	100	22220RHRK+AHX320	5.58	AN22
105	73	77	M110×2	11	100	23220RHK+AHX3220	7.43	AN22
	59	63	M110×2	10	100	21320RHK+AHX320	9.26	AN22
	90	94	M110×2	16	100	22320RHRK+AHX2320	13.9	AN22
115	68	72	M120×2	11	110	23122RHK+AHX3122	6.30	AN24
	82	91	M115×2	13	110	24122RHK30+AH24122	7.60	AN23
	68	72	M120×2	11	110	22222RHRK+AHX3122	7.97	AN24
	82	86	M125×2	11	110	23222RHK+AHX3222	10.5	AN25
	63	67	M120×2	12	110	21322RHK+AHX322	12.3	AN24
	98	102	M125×2	16	110	22322RHRK+AHX2322	19.1	AN25
115	60	64	M130×2	13	120	23024RHK+AHX3024	4.82	AN26
	73	82	M125×2	13	120	24024RHK30+AH24024	5.99	AN25
	75	79	M130×2	12	120	23124RHK+AHX3124	8.69	AN26
	93	102	M130×2	13	120	24124RHK30+AH24124	11.0	AN26
	75	79	M130×2	12	120	22224RHRK+AHX3124	10.1	AN26

[Note] 1) Basic profile and dimensions of screw thread identified by prefix M are in accordance with JIS B 0205. Basic profile and dimensions of screw thread identified by prefix Tr are in accordance with JIS B 0216.

Withdrawal sleeves for spherical roller bearings

d_1 (115) ~ (150) mm

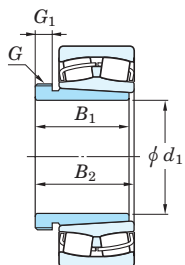

d_1 (150) ~ 170 mm

Boundary dimensions (mm)				Brg. bore d (mm)	Designations Bearing + withdrawal sleeve	Mass Brg.+withdrawal sleeve (kg)	(Refer.) Applicable locknut No.
d_1	B_1	B_2	$G^{1)}$ Screw size				
115	90	94	M135×2	13	23224RHK+ AHX3224	13.1	AN27
	105	109	M135×2	17	22324RHRK+ AHX2324	23.9	AN27
125	67	71	M140×2	14	23026RHK+ AHX3026	6.90	AN28
	83	93	M135×2	14	24026RHK30+ AH24026	8.74	AN27
	78	82	M140×2	12	23126RHK+ AHX3126	9.52	AN28
	94	104	M140×2	14	24126RHK30+ AH24126	11.7	AN28
	78	82	M140×2	12	22226RHRK+ AHX3126	12.4	AN28
	98	102	M145×2	15	23226RHK+ AHX3226	15.6	AN29
	115	119	M145×2	19	22326RHRK+ AHX2326	29.9	AN29
135	68	73	M150×2	14	23028RHK+ AHX3028	7.43	AN30
	83	93	M145×2	14	24028RHK30+ AH24028	9.26	AN29
	83	88	M150×2	14	23128RHK+ AHX3128	11.5	AN30
	99	109	M150×2	14	24128RHK30+ AH24128	14.1	AN30
	83	88	M150×2	14	22228RHRK+ AHX3128	15.4	AN30
	104	109	M155×3	15	23228RHK+ AHX3228	20.3	AN31
	125	130	M155×3	20	22328RHK+ AHX2328	35.0	AN31
	145	72	77	M160×3	15	23030RHK+ AHX3030	8.92
90		101	M155×3	15	24030RHK30+ AH24030	11.4	AN31
96		101	M165×3	15	23130RHK+ AHX3130	17.7	AN33
115		126	M160×3	15	24130RHK30+ AH24130	21.2	AN32
96		101	M165×3	15	22230RHRK+ AHX3130	20.3	AN33
114		119	M165×3	17	23230RHK+ AHX3230	26.0	AN33
135		140	M165×3	24	22330RK+ AHX2330	45.5	AN33
135		140	M165×3	24	22330RHAK+ AHX2330	42.2	AN33
150	77	82	M170×3	16	23032RHK+ AHX3032	11.5	AN34
	95	106	M170×3	15	24032RHK30+ AH24032	15.0	AN34
	103	108	M180×3	16	23132RHK+ AHX3132	23.4	AN36

Boundary dimensions (mm)				Brg. bore d (mm)	Designations Bearing + withdrawal sleeve	Mass Brg.+withdrawal sleeve (kg)	(Refer.) Applicable locknut No.
d_1	B_1	B_2	$G^{1)}$ Screw size				
150	103	108	M180×3	16	22232RK+ AH3132	26.1	AN36
	103	108	M180×3	16	22232RHAK+ AH3132	24.6	AN36
	124	130	M180×3	20	23232RK+ AH3232	35.1	AN36
	124	130	M180×3	20	23232RHAK+ AH3232	32.6	AN36
	140	146	M180×3	24	22332RK+ AH2332	55.7	AN36
	140	146	M180×3	24	22332RHAK+ AH2332	51.8	AN36
160	85	90	M180×3	17	23034RHK+ AH3034	15.2	AN36
	106	117	M180×3	16	24034RHK30+ AH24034	20.0	AN36
	104	109	M190×3	16	23134RHK+ AH3134	24.6	AN38
	125	136	M180×3	16	24134RRK30+ AH24134	30.0	AN36
	104	109	M190×3	16	22234RK+ AH3134	31.8	AN38
	104	109	M190×3	16	22234RHAK+ AH3134	29.9	AN38
	134	140	M190×3	24	23234RK+ AH3234	42.3	AN38
	134	140	M190×3	24	23234RHAK+ AH3234	39.4	AN38
	146	152	M190×3	24	22334RK+ AH2334	66.1	AN38
	146	152	M190×3	24	22334RHAK+ AH2334	61.4	AN38
170	92	98	M190×3	17	23036RHK+ AH3036	19.7	AN38
	116	127	M190×3	16	24036RRK30+ AH24036	26.1	AN38
	116	122	M200×3	19	23136RK+ AH3136	31.7	AN40
	116	122	M200×3	19	23136RHAK+ AH3136	29.8	AN40
	134	145	M190×3	16	24136RRK30+ AH24136	37.6	AN38
	134	145	M190×3	16	24136RHAK30+ AH24136	34.9	AN38
	105	110	M200×3	17	22236RK+ AH2236	33.5	AN40
	105	110	M200×3	17	22236RHAK+ AH2236	31.5	AN40
	140	146	M200×3	24	23236RK+ AH3236	45.1	AN40
	140	146	M200×3	24	23236RHAK+ AH3236	41.8	AN40
	154	160	M200×3	24	22336RK+ AH2336	75.7	AN40
	154	160	M200×3	24	22336RHAK+ AH2336	70.3	AN40

[Note] 1) Basic profile and dimensions of screw thread identified by prefix M are in accordance with JIS B 0205.
Basic profile and dimensions of screw thread identified by prefix Tr are in accordance with JIS B 0216.

Withdrawal sleeves for spherical roller bearings
 d_1 180 ~ 190 mm

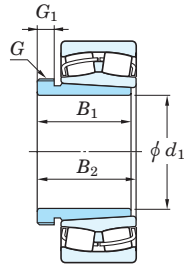
 d_1 200 ~ 220 mm

d_1	Boundary dimensions (mm)				Brg. bore d (mm)	Designations Bearing + withdrawal sleeve	Mass Brg.+withdrawal sleeve (kg)	(Refer.) Applicable locknut No.	
	B_1	B_2	$G^{1)}$ Screw size	G_1					
180	96	102	Tr205×4	18	190	23038RK+ AH3038	21.5	HNL41	
	96	102	Tr205×4	18	190	23038RHAK+ AH3038	19.9	HNL41	
	118	131	M200×3	18	190	24038RRK30+ AH24038	27.6	AN40	
	118	131	M200×3	18	190	24038RHAK30+ AH24038	25.5	AN40	
	125	131	Tr210×4	20	190	23138RK+ AH3138	39.3	HN42	
	125	131	Tr210×4	20	190	23138RHAK+ AH3138	37.0	HN42	
	146	159	M200×3	18	190	24138RRK30+ AH24138	46.7	AN40	
	146	159	M200×3	18	190	24138RHAK30+ AH24138	43.8	AN40	
	112	117	Tr210×4	18	190	22238RK+ AH2238	40.9	HN42	
	112	117	Tr210×4	18	190	22238RHAK+ AH2238	38.4	HN42	
	145	152	Tr210×4	25	190	23238RK+ AH3238	53.3	HN42	
	145	152	Tr210×4	25	190	23238RHAK+ AH3238	49.4	HN42	
	160	167	Tr210×4	26	190	22338RK+ AH2338	89.0	HN42	
	160	167	Tr210×4	26	190	22338RHAK+ AH2338	82.6	HN42	
	190	102	108	Tr215×4	19	200	23040RK+ AH3040	27.2	HNL43
		102	108	Tr215×4	19	200	23040RHAK+ AH3040	25.1	HNL43
127		140	Tr210×4	18	200	24040RRK30+ AH24040	34.6	HN42	
127		140	Tr210×4	18	200	24040RHAK30+ AH24040	31.9	HN42	
134		140	Tr220×4	21	200	23140RK+ AH3140	47.9	HN44	
134		140	Tr220×4	21	200	23140RHAK+ AH3140	45.0	HN44	
158		171	Tr210×4	18	200	24140RRK30+ AH24140	57.6	HN42	
158		171	Tr210×4	18	200	24140RHAK30+ AH24140	53.8	HN42	
118		123	Tr220×4	19	200	22240RK+ AH2240	48.7	HN44	
118		123	Tr220×4	19	200	22240RHAK+ AH2240	45.7	HN44	
153		160	Tr220×4	25	200	23240RK+ AH3240	64.7	HN44	
153		160	Tr220×4	25	200	23240RHAK+ AH3240	60.1	HN44	
170		177	Tr220×4	26	200	22340RK+ AH2340	101	HN44	
170		177	Tr220×4	26	200	22340RHAK+ AH2340	93.4	HN44	

[Note] 1) Basic profile and dimensions of screw thread identified by prefix M are in accordance with JIS B 0205.
Basic profile and dimensions of screw thread identified by prefix Tr are in accordance with JIS B 0216.

d_1	Boundary dimensions (mm)				Brg. bore d (mm)	Designations Bearing + withdrawal sleeve	Mass Brg.+withdrawal sleeve (kg)	(Refer.) Applicable locknut No.	
	B_1	B_2	$G^{1)}$ Screw size	G_1					
200	111	117	Tr235×4	20	220	23044RK+ AH3044	38.0	HNL47	
	111	117	Tr235×4	20	220	23044RHAK+ AH3044	35.3	HNL47	
	138	152	Tr230×4	20	220	24044RRK30+ AH24044	48.1	—	
	138	152	Tr230×4	20	220	24044RHAK30+ AH24044	44.7	—	
	145	151	Tr240×4	23	220	23144RK+ AH3144	63.6	HN48	
	145	151	Tr240×4	23	220	23144RHAK+ AH3144	60.0	HN48	
	170	184	Tr230×4	20	220	24144RRK30+ AH24144	76.4	—	
	170	184	Tr230×4	20	220	24144RHAK30+ AH24144	71.2	—	
	130	136	Tr240×4	20	220	22244RK+ AH2244	70.8	HN48	
	130	136	Tr240×4	20	220	22244RHAK+ AH2244	66.6	HN48	
	181	189	Tr240×4	30	220	23244RK+ AH2344	95.1	HN48	
	181	189	Tr240×4	30	220	23244RHAK+ AH2344	88.5	HN48	
	181	189	Tr240×4	30	220	22344RK+ AH2344	136	HN48	
	181	189	Tr240×4	30	220	22344RHAK+ AH2344	127	HN48	
	220	116	123	Tr260×4	21	240	23048RK+ AH3048	42.6	HNL52
		116	123	Tr260×4	21	240	23048RHAK+ AH3048	39.7	HNL52
138		153	Tr250×4	20	240	24048RRK30+ AH24048	51.9	—	
138		153	Tr250×4	20	240	24048RHAK30+ AH24048	48.0	—	
154		161	Tr260×4	25	240	23148RK+ AH3148	77.6	HN52	
154		161	Tr260×4	25	240	23148RHAK+ AH3148	73.1	HN52	
180		195	Tr260×4	20	240	24148RRK30+ AH24148	94.0	HN52	
180		195	Tr260×4	20	240	24148RHAK30+ AH24148	87.9	HN52	
144		150	Tr260×4	21	240	22248RK+ AH2248	94.3	HN52	
144		150	Tr260×4	21	240	22248RHAK+ AH2248	88.7	HN52	
189		197	Tr260×4	30	240	23248RK+ AH2348	126	HN52	
189		197	Tr260×4	30	240	23248RHAK+ AH2348	117	HN52	
189		197	Tr260×4	30	240	22348RK+ AH2348	170	HN52	
189		197	Tr260×4	30	240	22348RHAK+ AH2348	158	HN52	

d_1 240 ~ 260 mm

d_1 280 ~ (320) mm

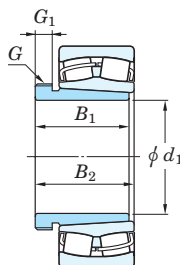

d_1	Boundary dimensions (mm)				Brg. bore d (mm)	Designations Bearing + withdrawal sleeve	Mass Brg.+withdrawal sleeve (kg)	(Refer.) Applicable locknut No.
	B_1	B_2	$G^{1)}$ Screw size	G_1				
240	128	135	Tr280x4	23	260	23052RK+AH3052	60.0	HNL56
	128	135	Tr280x4	23	260	23052RHAK+AH3052	55.6	HNL56
	162	178	Tr270x4	22	260	24052RRK30+AH24052	77.0	—
	162	178	Tr270x4	22	260	24052RHAK30+AH24052	71.2	—
	172	179	Tr290x4	26	260	23152RK+AH3152	107	HN58
	172	179	Tr290x4	26	260	23152RHAK+AH3152	101	HN58
	202	218	Tr280x4	22	260	24152RRK30+AH24152	128	—
	202	218	Tr280x4	22	260	24152RHAK30+AH24152	120	—
	155	161	Tr290x4	23	260	22252RK+AH2252	122	HN58
	155	161	Tr290x4	23	260	22252RHAK+AH2252	115	HN58
	205	213	Tr290x4	30	260	23252RK+AH2352	164	HN58
	205	213	Tr290x4	30	260	23252RHAK+AH2352	153	HN58
	205	213	Tr290x4	30	260	22352RK+AH2352	212	HN58
	205	213	Tr290x4	30	260	22352RHAK+AH2352	197	HN58
260	131	139	Tr300x4	24	280	23056RK+AH3056	64.9	HNL60
	131	139	Tr300x4	24	280	23056RHAK+AH3056	60.2	HNL60
	162	179	Tr290x4	22	280	24056RRK30+AH24056	81.9	HN58
	162	179	Tr290x4	22	280	24056RHAK30+AH24056	75.7	HN58
	175	183	Tr310x5	28	280	23156RK+AH3156	114	HN62
	175	183	Tr310x5	28	280	23156RHAK+AH3156	108	HN62
	202	219	Tr300x4	22	280	24156RRK30+AH24156	136	—
	202	219	Tr300x4	22	280	24156RHAK30+AH24156	128	—
	155	163	Tr310x5	24	280	22256RK+AH2256	127	HN62
	155	163	Tr310x5	24	280	22256RHAK+AH2256	119	HN62
	212	220	Tr310x5	30	280	23256RK+AH2356	175	HN62
	212	220	Tr310x5	30	280	23256RHAK+AH2356	163	HN62
	212	220	Tr310x5	30	280	22356RK+AH2356	247	HN62
	212	220	Tr310x5	30	280	22356RHAK+AH2356	230	HN62

d_1	Boundary dimensions (mm)				Brg. bore d (mm)	Designations Bearing + withdrawal sleeve	Mass Brg.+withdrawal sleeve (kg)	(Refer.) Applicable locknut No.
	B_1	B_2	$G^{1)}$ Screw size	G_1				
280	145	153	Tr320x5	26	300	23060RK+AH3060	88.1	HNL64
	145	153	Tr320x5	26	300	23060RHAK+AH3060	81.2	HNL64
	184	202	Tr310x5	24	300	24060RRK30+AH24060	112	HN62
	184	202	Tr310x5	24	300	24060RHAK30+AH24060	105	HN62
	192	200	Tr330x5	30	300	23160RK+AH3160	149	HN66
	192	200	Tr330x5	30	300	23160RHAK+AH3160	140	HN66
	224	242	Tr320x5	24	300	24160RRK30+AH24160	180	—
	224	242	Tr320x5	24	300	24160RHAK30+AH24160	168	—
	170	178	Tr330x5	26	300	22260RK+AH2260	160	HN66
	170	178	Tr330x5	26	300	22260RHAK+AH2260	150	HN66
	228	236	Tr330x5	34	300	23260RK+AH3260	223	HN66
228	236	Tr330x5	34	300	23260RHAK+AH3260	208	HN66	
300	149	157	Tr345x5	27	320	23064RK+AH3064	94.8	HNL69
	149	157	Tr345x5	27	320	23064RHAK+AH3064	88.1	HNL69
	184	202	Tr330x5	24	320	24064RRK30+AH24064	120	HN66
	184	202	Tr330x5	24	320	24064RHAK30+AH24064	108	HN66
	209	217	Tr350x5	31	320	23164RK+AH3164	191	HN70
	209	217	Tr350x5	31	320	23164RHAK+AH3164	180	HN70
	242	260	Tr340x5	24	320	24164RRK30+AH24164	226	—
	242	260	Tr340x5	24	320	24164RHAK30+AH24164	217	—
	180	190	Tr350x5	27	320	22264RK+AH2264	191	HN70
	246	254	Tr350x5	36	320	23264RK+AH3264	280	HN70
	246	254	Tr350x5	36	320	23264RHAK+AH3264	260	HN70
320	162	171	Tr365x5	28	340	23068RK+AH3068	125	HNL73
	162	171	Tr365x5	28	340	23068RHAK+AH3068	115	HNL73
	225	234	Tr370x5	33	340	23168RK+AH3168	239	HN74
	225	234	Tr370x5	33	340	23168RHAK+AH3168	225	HN74
	269	288	Tr360x5	26	340	24168RRK30+AH24168	293	—

[Note] 1) Basic profile and dimensions of screw thread identified by prefix M are in accordance with JIS B 0205.
Basic profile and dimensions of screw thread identified by prefix Tr are in accordance with JIS B 0216.

Withdrawal sleeves for spherical roller bearings

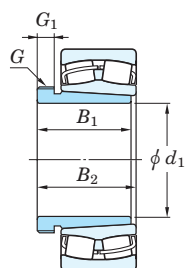
 d_1 (320) ~ 380 mm d_1 400 ~ 480 mm

d_1	Boundary dimensions (mm)			G_1	Brg. bore d (mm)	Designations Bearing + withdrawal sleeve	Mass Brg.+withdrawal sleeve (kg)	(Refer.) Applicable locknut No.
	B_1	B_2	G ¹⁾ Screw size					
320	269	288	Tr360x5	26	340	24168RHAK30+AH24168	282	—
	264	273	Tr370x5	38	340	23268RK+AH3268	342	HN74
	264	273	Tr370x5	38	340	23268RHAK+AH3268	317	HN74
340	167	176	Tr385x5	30	360	23072RK+AH3072	132	HNL77
	167	176	Tr385x5	30	360	23072RHAK+AH3072	122	HNL77
	229	238	Tr400x5	35	360	23172RK+AH3172	254	HN80
	232	238	Tr400x5	35	360	23172RHAK+AH3172	239	HN80
	269	289	Tr380x5	26	360	24172RK30+AH24172	313	—
	269	289	Tr380x5	26	360	24172RHAK30+AH24172	300	—
	274	283	Tr400x5	40	360	23272RK+AH3272	388	HN80
	274	283	Tr400x5	40	360	23272RHAK+AH3272	360	HN80
	360	170	180	Tr410x5	31	380	23076RK+AH3076	141
170		180	Tr410x5	31	380	23076RHAK+AH3076	131	HNL82
232		242	Tr420x5	36	380	23176RK+AH3176	269	HN84
240		242	Tr420x5	36	380	23176RHAK+AH3176	253	HN84
271		291	Tr400x5	28	380	24176RK30+AH24176	328	HN80
271		291	Tr400x5	28	380	24176RHAK30+AH24176	314	HN80
284		294	Tr420x5	42	380	23276RK+AH3276	432	HN84
284		294	Tr420x5	42	380	23276RHAK+AH3276	400	HN84
380	183	193	Tr430x5	33	400	23080RK+AH3080	178	HNL86
	183	193	Tr430x5	33	400	23080RHAK+AH3080	165	HNL86
	240	250	Tr440x5	38	400	23180RK+AH3180	305	HN88
	266	250	Tr440x5	38	400	23180RHAK+AH3180	287	HN88
	278	298	Tr420x5	28	400	24180RK30+AH24180	368	HN84
	278	298	Tr420x5	28	400	24180RHAK30+AH24180	352	HN84
	302	312	Tr440x5	44	400	23280RK+AH3280	521	HN88
	302	312	Tr440x5	44	400	23280RHAK+AH3280	480	HN88

d_1	Boundary dimensions (mm)			G_1	Brg. bore d (mm)	Designations Bearing + withdrawal sleeve	Mass Brg.+withdrawal sleeve (kg)	(Refer.) Applicable locknut No.
	B_1	B_2	G ¹⁾ Screw size					
400	186	196	Tr450x5	34	420	23084RK+AH3084	188	HNL90
	186	196	Tr450x5	34	420	23084RHAK+AH3084	174	HNL90
	266	276	Tr460x5	40	420	23184RK+AH3184	399	HN92
	270	276	Tr460x5	40	420	23184RHAK+AH3184	375	HN92
	321	331	Tr460x5	46	420	23284RK+AH3284	673	HN92
	321	331	Tr460x5	46	420	23284RHAK+AH3284	568	HN92
420	194	205	Tr470x5	35	440	23088RK+AHX3088	215	HNL94
	194	205	Tr470x5	35	440	23088RHAK+AHX3088	199	HNL94
	270	281	Tr480x5	42	440	23188RK+AHX3188	416	HN96
	285	281	Tr480x5	42	440	23188RHAK+AHX3188	391	HN96
	330	341	Tr480x5	48	440	23288RK+AHX3288	678	HN96
	330	341	Tr480x5	48	440	23288RHAK+AHX3288	627	HN96
440	202	213	Tr490x5	37	460	23092RK+AHX3092	244	HNL98
	202	213	Tr490x5	37	460	23092RHAK+AHX3092	226	HNL98
	285	296	Tr510x6	43	460	23192RK+AHX3192	494	HN102
	295	296	Tr510x6	43	460	23192RHAK+AHX3192	464	HN102
	349	360	Tr510x6	50	460	23292RK+AHX3292	795	HN102
	349	360	Tr510x6	50	460	23292RHAK+AHX3292	733	HN102
460	205	217	Tr520x6	38	480	23096RK+AHX3096	257	HNL104
	205	217	Tr520x6	38	480	23096RHAK+AHX3096	238	HNL104
	295	307	Tr530x6	45	480	23196RK+AHX3196	551	HN106
	313	307	Tr530x6	45	480	23196RHAK+AHX3196	518	HN106
	364	376	Tr530x6	52	480	23296RK+AHX3296	914	HN106
	364	376	Tr530x6	52	480	23296RHAK+AHX3296	844	HN106
480	209	221	Tr540x6	40	500	230/500RK+AHX30/500	271	HNL108
	313	325	Tr550x6	47	500	231/500RK+AHX31/500	648	HN110
	393	405	Tr550x6	54	500	232/500RK+AHX32/500	1 015	HN110

[Note] 1) Basic profile and dimensions of screw thread identified by prefix M are in accordance with JIS B 0205.
Basic profile and dimensions of screw thread identified by prefix Tr are in accordance with JIS B 0216.

Thrust ball bearings

Thrust ball bearings are divided into single and double direction types. The former is able to accommodate axial load in one direction, while the latter is able to accommodate it in both directions.

Neither is suitable for applications that involve radial load or high-speed rotation.

Bearings whose housing race back face is spherical (with a spherical back face or aligning seat race) are designed with a self-aligning capability and can accommodate the effects of inaccurate mounting.

Single direction thrust ball bearings

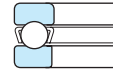

Bore diameter **10 – 360 mm**

Double direction thrust ball bearings

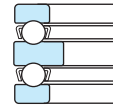

Bore diameter **10 – 190 mm**



Boundary dimensions	As specified in JIS B 1512.
Tolerances	As specified in JIS B 1514-2. (refer to Table 7-9 on p. A 68.)
Recommended fits	Refer to Table 9-8 on p. A 92.
Standard cages	<ul style="list-style-type: none"> • Pressed steel cage (supplementary code : //) • Copper alloy or carbon steel machined cage (supplementary code : FY or FC) • Polyamide resin molded cage (supplementary code : MG)

Application of standard cages

Bearing series	Molded cage	Pressed cage	Machined cage
511	51100 – 51107	51108 – 51132	51134 – 51172
512	51200 – 51207	51208 – 51224	51226 – 51272
532	53200 – 53207	53208 – 53224	53226 – 53272
532 U	53200U – 53207U	53208U – 53224U	53226U – 53272U
513	–	51305 – 51313	51314 – 51340
533	–	53305 – 53313	53314 – 53340
533 U	–	53305U – 53313U	53314U – 53340U
514	–	51405 – 51416	51417 – 51436
534	–	53405 – 53416	53417 – 53420
534 U	–	53405U – 53416U	53417U – 53420U
522	–	52202 – 52224	52226 – 52244
542	–	54202 – 54224	54226 – 54244
542 U	–	54205U – 54224U	54226U – 54244U
523	–	52305 – 52313	52314 – 52340
543	–	54305 – 54313	54314 – 54324
543 U	–	54305U – 54313U	54314U – 54324U
524	–	52405 – 52411	52412 – 52444
544	–	54405 – 54411	54412 – 54420
544 U	–	54405U – 54411U	54412U – 54420U

Required minimum axial load	A certain degree of load is necessary in order for bearings to operate satisfactorily. (refer to p. A 110.)
Allowable misalignment	Misalignment not allowed. (for flat back face type.)
Equivalent axial load	Dynamic equivalent axial load $P_a = F_a$ Static equivalent axial load $P_{0a} = F_a$

Single direction thrust ball bearings

d 10 ~ (40) mm

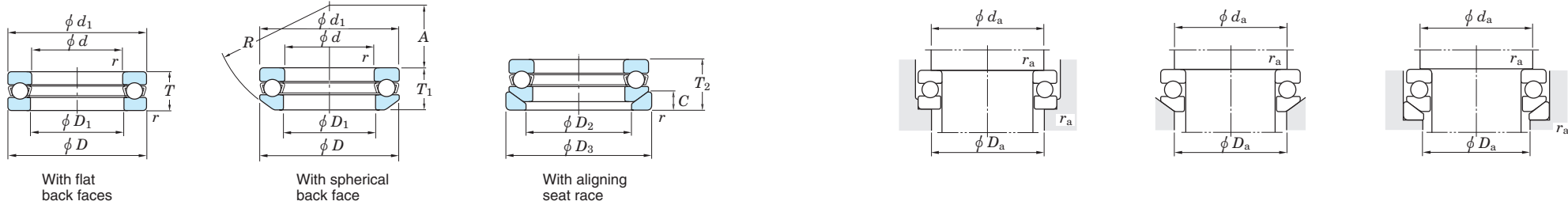

<i>d</i>	Boundary dimensions (mm)					Basic load ratings (kN)		Limiting speeds (min ⁻¹)		Bearing No.			Dimensions (mm)						Mounting dimensions (mm)			(Refer.) Mass (kg)			
	<i>D</i>	<i>T</i>	<i>T</i> ₁	<i>T</i> ₂	<i>r</i> _{min.}	<i>C</i> _a	<i>C</i> _{0a}	Grease lub.	Oil lub.	With flat back faces	With spherical back face	With aligning seat race	<i>d</i> ₁ max.	<i>D</i> ₁ min.	<i>D</i> ₂	<i>D</i> ₃	<i>A</i>	<i>R</i>	<i>C</i>	<i>d</i> _a min.	<i>D</i> _a max.	<i>r</i> _a max.	With flat back faces	With spherical back face	With aligning seat race
10	24	9	—	—	0.3	10.0	14.0	6 500	10 000	51100	—	—	24	11	—	—	—	—	—	18	16	0.3	0.020	—	—
	26	11	11.6	13	0.6	12.7	17.1	5 700	8 800	51200	53200	53200U	26	12	18	28	8.5	22	3.5	20	16	0.6	0.030	0.029	0.037
12	26	9	—	—	0.3	9.65	14.0	6 500	10 000	51101	—	—	26	13	—	—	—	—	—	20	18	0.3	0.022	—	—
	28	11	11.4	13	0.6	13.2	19.0	5 400	8 300	51201	53201	53201U	28	14	20	30	11.5	25	3.5	22	18	0.6	0.034	0.031	0.043
15	28	9	—	—	0.3	9.95	15.4	6 100	9 400	51102	—	—	28	16	—	—	—	—	—	23	20	0.3	0.024	—	—
	32	12	13.3	15	0.6	16.6	24.8	4 900	7 500	51202	53202	53202U	32	17	24	35	12	28	4	25	22	0.6	0.046	0.048	0.062
17	30	9	—	—	0.3	10.8	18.2	6 100	9 400	51103	—	—	30	18	—	—	—	—	—	25	22	0.3	0.028	—	—
	35	12	13.2	15	0.6	17.2	27.3	4 900	7 500	51203	53203	53203U	35	19	26	38	16	32	4	28	24	0.6	0.053	0.055	0.070
20	35	10	—	—	0.3	14.2	24.7	5 100	7 900	51104	—	—	35	21	—	—	—	—	—	29	26	0.3	0.040	—	—
	40	14	14.7	17	0.6	22.3	37.7	3 900	6 000	51204	53204	53204U	40	22	30	42	18	36	5	32	28	0.6	0.082	0.080	0.100
25	42	11	—	—	0.6	19.5	37.2	4 400	6 800	51105	—	—	42	26	—	—	—	—	—	35	32	0.6	0.059	—	—
	47	15	16.7	19	0.6	27.8	50.4	3 600	5 500	51205	53205	53205U	47	27	36	50	19	40	5.5	38	34	0.6	0.120	0.120	0.152
	52	18	19.8	22	1	35.7	61.4	3 100	4 800	51305	53305	53305U	52	27	38	55	21	45	6	41	36	1	0.180	0.180	0.224
	60	24	26.4	29	1	55.6	89.4	2 600	4 000	51405	53405	53405U	60	27	42	62	19	50	8	46	39	1	0.340	0.350	0.442
30	47	11	—	—	0.6	20.4	42.2	4 300	6 600	51106	—	—	47	32	—	—	—	—	—	40	37	0.6	0.068	—	—
	52	16	17.8	20	0.6	29.4	58.2	3 400	5 200	51206	53206	53206U	52	32	42	55	22	45	5.5	43	39	0.6	0.150	0.160	0.193
	60	21	22.6	25	1	42.8	78.7	2 700	4 200	51306	53306	53306U	60	32	45	62	22	50	7	48	42	1	0.270	0.270	0.326
	70	28	30.1	33	1	72.8	126	2 200	3 400	51406	53406	53406U	70	32	50	75	20	56	9	54	46	1	0.530	0.530	0.660
35	52	12	—	—	0.6	21.2	47.2	3 900	6 000	51107	—	—	52	37	—	—	—	—	—	45	42	0.6	0.090	—	—
	62	18	19.9	22	1	39.2	78.2	2 900	4 500	51207	53207	53207U	62	37	48	65	24	50	7	51	46	1	0.220	0.220	0.277
	68	24	25.6	28	1	55.5	105	2 400	3 700	51307	53307	53307U	68	37	52	72	24	56	7.5	55	48	1	0.390	0.400	0.484
	80	32	34	37	1.1	87.1	155	1 900	2 900	51407	53407	53407U	80	37	58	85	23	64	10	62	53	1	0.790	0.790	0.960
40	60	13	—	—	0.6	26.9	62.8	3 400	5 300	51108	—	—	60	42	—	—	—	—	—	52	48	0.6	0.120	—	—
	68	19	20.3	23	1	47.0	98.3	2 700	4 200	51208	53208	53208U	68	42	55	72	28.5	56	7	57	51	1	0.270	0.270	0.340
	78	26	28.5	31	1	69.3	135	2 100	3 300	51308	53308	53308U	78	42	60	82	28	64	8.5	63	55	1	0.550	0.570	0.690

[Remark] Standard cage types used for the above bearings are described earlier in this section.

Single direction thrust ball bearings

d (40) ~ 70 mm

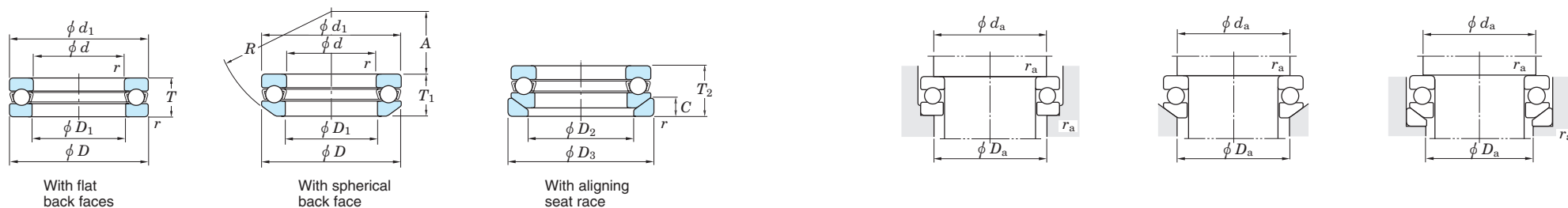

Boundary dimensions (mm)						Basic load ratings (kN)		Limiting speeds (min ⁻¹)		Bearing No.			Dimensions (mm)						Mounting dimensions (mm)			(Refer.) Mass (kg)			
d	D	T	T_1	T_2	$r_{min.}$	C_a	C_{0a}	Grease lub.	Oil lub.	With flat back faces	With spherical back face	With aligning seat race	d_1 max.	D_1 min.	D_2	D_3	A	R	C	d_a min.	D_a max.	r_a max.	With flat back faces	With spherical back face	With aligning seat race
40	90	36	38.2	42	1.1	113	205	1 700	2 600	51408	53408	53408U	90	42	65	95	26	72	12	70	60	1	1.14	1.12	1.37
	73	20	21.3	24	1	47.7	105	2 600	4 000	51209	53209	53209U	73	47	60	78	26	56	7.5	62	56	1	0.320	0.310	0.397
45	85	28	30.1	33	1	80.0	163	1 900	3 000	51309	53309	53309U	85	47	65	90	25	64	10	69	61	1	0.690	0.680	0.850
	100	39	42.4	46	1.1	130	242	1 500	2 300	51409	53409	53409U	100	47	72	105	29	80	12.5	78	67	1	1.47	1.50	1.82
50	70	14	—	—	0.6	28.8	75.4	3 100	4 800	51110	—	—	70	52	—	—	—	—	—	62	58	0.6	0.160	—	—
	78	22	23.5	26	1	48.5	111	2 300	3 600	51210	53210	53210U	78	52	62	82	32.5	64	7.5	67	61	1	0.390	0.380	0.480
	95	31	34.3	37	1.1	96.6	202	1 800	2 700	51310	53310	53310U	95	52	72	100	28	72	11	77	68	1	1.00	1.01	1.24
	110	43	45.6	50	1.5	148	283	1 400	2 100	51410	53410	53410U	110	52	80	115	35	90	14	86	74	1.5	1.99	1.97	2.38
55	78	16	—	—	0.6	34.8	93.1	2 800	4 300	51111	—	—	78	57	—	—	—	—	—	69	64	0.6	0.240	—	—
	90	25	27.3	30	1	69.4	159	2 100	3 200	51211	53211	53211U	90	57	72	95	35	72	9	76	69	1	0.610	0.620	0.770
	105	35	39.3	42	1.1	119	246	1 600	2 400	51311	53311	53311U	105	57	80	110	30	80	11.5	85	75	1	1.34	1.41	1.69
	120	48	50.5	55	1.5	178	359	1 200	1 900	51411	53411	53411U	120	57	88	125	28	90	15.5	94	81	1.5	2.64	2.57	3.10
60	85	17	—	—	1	41.4	113	2 600	4 000	51112	—	—	85	62	—	—	—	—	—	75	70	1	0.290	—	—
	95	26	28	31	1	73.6	179	1 900	3 000	51212	53212	53212U	95	62	78	100	32.5	72	9	81	74	1	0.690	0.690	0.850
	110	35	38.3	42	1.1	124	267	1 500	2 300	51312	53312	53312U	110	62	85	115	41	90	11.5	90	80	1	1.43	1.47	1.78
	130	51	54	58	1.5	214	437	1 100	1 700	51412	53412	53412U	130	62	95	135	34	100	16	102	88	1.5	3.51	3.44	4.13
65	90	18	—	—	1	41.7	117	2 400	3 700	51113	—	—	90	67	—	—	—	—	—	80	75	1	0.340	—	—
	100	27	28.7	32	1	74.9	189	1 900	2 900	51213	53213	53213U	100	67	82	105	40	80	9	86	79	1	0.770	0.750	0.930
	115	36	39.4	43	1.1	128	287	1 400	2 200	51313	53313	53313U	115	67	90	120	38.5	90	12.5	95	85	1	1.57	1.61	1.95
	140	56	60.2	65	2	232	493	1 000	1 600	51413	53413	53413U	140	68	100	145	40	112	17.5	110	95	2	4.47	4.47	5.28
70	95	18	—	—	1	43.1	127	2 300	3 600	51114	—	—	95	72	—	—	—	—	—	85	80	1	0.360	—	—
	105	27	28.8	32	1	76.1	199	1 800	2 800	51214	53214	53214U	105	72	88	110	38	80	9	91	84	1	0.810	0.800	0.990
	125	40	44.2	48	1.1	134	291	1 300	2 000	51314	53314	53314U	125	72	98	130	43	100	13	103	92	1	2.06	2.15	2.56
	150	60	63.6	69	2	250	553	940	1 450	51414	53414	53414U	150	73	110	155	34	112	19.5	118	102	2	5.48	5.38	6.37

[Remark] Standard cage types used for the above bearings are described earlier in this section.

Single direction thrust ball bearings

d 75 ~ (120) mm

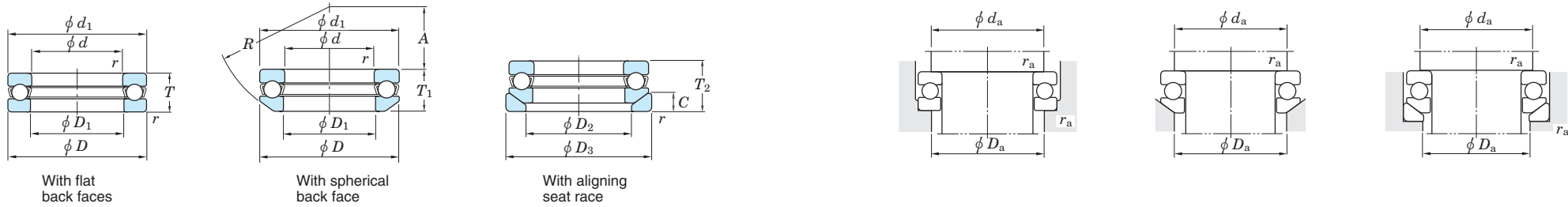

<i>d</i>	Boundary dimensions (mm)					Basic load ratings (kN)		Limiting speeds (min ⁻¹)		Bearing No.			Dimensions (mm)						Mounting dimensions (mm)			(Refer.) Mass (kg)			
	<i>D</i>	<i>T</i>	<i>T</i> ₁	<i>T</i> ₂	<i>r</i> _{min.}	<i>C</i> _a	<i>C</i> _{0a}	Grease lub.	Oil lub.	With flat back faces	With spherical back face	With aligning seat race	<i>d</i> ₁ max.	<i>D</i> ₁ min.	<i>D</i> ₂	<i>D</i> ₃	<i>A</i>	<i>R</i>	<i>C</i>	<i>d</i> _a min.	<i>D</i> _a max.	<i>r</i> _a max.	With flat back faces	With spherical back face	With aligning seat race
75	100	19	—	—	1	44.4	136	2 200	3 400	51115	—	—	100	77	—	—	—	—	—	90	85	1	0.420	—	—
	110	27	28.3	32	1	77.4	209	1 800	2 700	51215	53215	53215U	110	77	92	115	49	90	9.5	96	89	1	0.860	0.850	1.06
	135	44	48.1	52	1.5	154	339	1 200	1 900	51315	53315	53315U	135	77	105	140	37	100	15	111	99	1.5	2.68	2.72	3.27
	160	65	69	75	2	252	560	880	1 350	51415	53415	53415U	160	78	115	165	42	125	21	125	110	2	6.75	6.64	7.87
80	105	19	—	—	1	44.7	141	2 100	3 300	51116	—	—	105	82	—	—	—	—	—	95	90	1	0.430	—	—
	115	28	29.5	33	1	78.5	218	1 700	2 600	51216	53216	53216U	115	82	98	120	46	90	10	101	94	1	0.950	0.930	1.15
	140	44	47.6	52	1.5	160	368	1 200	1 800	51316	53316	53316U	140	82	110	145	50	112	15	116	104	1.5	2.82	2.86	3.43
	170	68	72.2	78	2.1	270	621	810	1 250	51416	53416	53416U	170	83	125	175	36	125	22	133	117	2	7.97	7.84	9.22
85	110	19	—	—	1	45.9	150	2 100	3 200	51117	—	—	110	87	—	—	—	—	—	100	95	1	0.460	—	—
	125	31	33.1	37	1	95.4	264	1 500	2 300	51217	53217	53217U	125	88	105	130	52	100	11	109	101	1	1.29	1.28	1.57
	150	49	53.1	58	1.5	186	419	1 100	1 700	51317	53317	53317U	150	88	115	155	43	112	17.5	124	111	1.5	3.66	3.63	4.44
	180	72	77	83	2.1	307	753	780	1 200	51417	53417	53417U	177	88	130	185	47	140	23	141	124	2	9.29	9.20	10.8
90	120	22	—	—	1	59.7	190	1 900	2 900	51118	—	—	120	92	—	—	—	—	—	108	102	1	0.680	—	—
	135	35	38.5	42	1.1	117	326	1 400	2 100	51218	53218	53218U	135	93	110	140	45	100	13.5	117	108	1	1.77	1.77	2.19
	155	50	54.6	59	1.5	193	454	1 000	1 600	51318	53318	53318U	155	93	120	160	40	112	18	129	116	1.5	3.88	3.87	4.71
	190	77	81.2	88	2.1	327	826	710	1 100	51418	53418	53418U	187	93	140	195	40	140	25.5	149	131	2	11.0	10.7	12.6
100	135	25	—	—	1	85.0	268	1 600	2 500	51120	—	—	135	102	—	—	—	—	—	121	114	1	0.990	—	—
	150	38	40.9	45	1.1	146	410	1 200	1 900	51220	53220	53220U	150	103	125	155	52	112	14	130	120	1	2.36	2.34	2.84
	170	55	59.2	64	1.5	236	595	940	1 450	51320	53320	53320U	170	103	135	175	46	125	18	142	128	1.5	5.11	5.10	6.05
	210	85	90	98	3	368	983	620	950	51420	53420	53420U	205	103	155	220	50	160	27	165	145	2.5	14.6	14.5	17.4
110	145	25	—	—	1	87.0	288	1 600	2 400	51122	—	—	145	112	—	—	—	—	—	131	124	1	1.08	—	—
	160	38	40.2	45	1.1	152	450	1 200	1 800	51222	53222	53222U	160	113	135	165	65	125	14	140	130	1	2.57	2.50	3.06
	190	63	67.2	72	2	267	704	810	1 250	51322	53322	53322U	187	113	150	195	51	140	20.5	158	142	2	7.72	7.63	8.90
	230	95	—	—	3	379	1 070	550	850	51422	—	—	225	113	—	—	—	—	—	181	159	2.5	19.8	—	—
120	155	25	—	—	1	89.0	305	1 500	2 300	51124	—	—	155	122	—	—	—	—	—	141	134	1	1.16	—	—

[Remark] Standard cage types used for the above bearings are described earlier in this section.

Single direction thrust ball bearings

d (120) ~ (180) mm

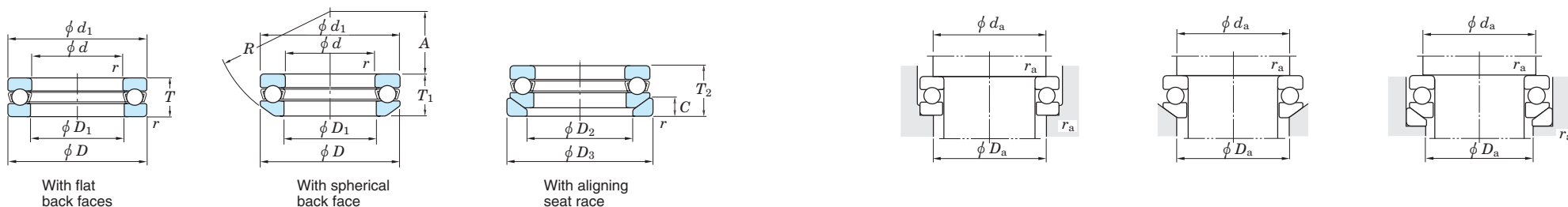

Boundary dimensions (mm)						Basic load ratings (kN)		Limiting speeds (min ⁻¹)		Bearing No.			Dimensions (mm)						Mounting dimensions (mm)			(Refer.) Mass (kg)			
d	D	T	T_1	T_2	$r_{min.}$	C_a	C_{0a}	Grease lub.	Oil lub.	With flat back faces	With spherical back face	With aligning seat race	d_1 max.	D_1 min.	D_2	D_3	A	R	C	d_a min.	D_a max.	r_a max.	With flat back faces	With spherical back face	With aligning seat race
120	170	39	40.8	46	1.1	154	470	1 100	1 700	51224	53224	53224U	170	123	145	175	61	125	15	150	140	1	2.86	2.81	3.46
	210	70	74.1	80	2.1	311	869	710	1 100	51324	53324	53324U	205	123	165	220	63	160	22	173	157	2	10.6	10.4	12.4
	250	102	—	—	4	480	1 460	520	800	51424	—	—	245	123	—	—	—	—	—	196	174	3	25.0	—	—
130	170	30	—	—	1	104	350	1 300	2 000	51126	—	—	170	132	—	—	—	—	—	154	146	1	1.87	—	—
	190	45	47.9	53	1.5	203	620	970	1 500	51226	53226	53226U	187	133	160	195	67	140	17	166	154	1.5	4.09	3.98	4.88
	225	75	80.3	86	2.1	330	958	650	1 000	51326	53326	53326U	220	134	177	235	53	160	26	186	169	2	13.0	12.7	15.2
	270	110	—	—	4	498	1 540	490	750	51426	—	—	265	134	—	—	—	—	—	212	188	3	31.4	—	—
140	180	31	—	—	1	107	375	1 200	1 900	51128	—	—	178	142	—	—	—	—	—	164	156	1	2.02	—	—
	200	46	48.6	55	1.5	205	650	940	1 450	51228	53228	53228U	197	143	170	210	87	160	17	176	164	1.5	4.46	4.35	5.89
	240	80	84.9	92	2.1	365	1 130	620	950	51328	53328	53328U	235	144	190	250	68	180	26	199	181	2	15.5	15.1	18.0
	280	112	—	—	4	520	1 680	450	700	51428	—	—	275	144	—	—	—	—	—	222	198	3	33.9	—	—
150	190	31	—	—	1	109	400	1 200	1 900	51130	—	—	188	152	—	—	—	—	—	174	166	1	2.15	—	—
	215	50	53.3	60	1.5	213	652	840	1 300	51230	53230	53230U	212	153	180	225	79	160	20.5	189	176	1.5	5.64	5.45	7.14
	250	80	83.7	92	2.1	361	1 130	580	900	51330	53330	53330U	245	154	200	260	89.5	200	26	209	191	2	16.3	15.7	18.8
	300	120	—	—	4	568	1 910	420	650	51430	—	—	295	154	—	—	—	—	—	238	212	3	41.6	—	—
160	200	31	—	—	1	112	425	1 200	1 800	51132	—	—	198	162	—	—	—	—	—	184	176	1	2.28	—	—
	225	51	54.7	61	1.5	223	718	810	1 250	51232	53232	53232U	222	163	190	235	74	160	21	199	186	1.5	6.53	6.09	7.90
	270	87	91.7	100	3	410	1 340	550	850	51332	53332	53332U	265	164	215	280	77	200	29	225	205	2.5	21.0	21.0	23.4
	320	130	—	—	5	681	2 410	390	600	51432	—	—	315	164	—	—	—	—	—	254	226	4	51.2	—	—
170	215	34	—	—	1.1	134	510	1 100	1 700	51134	—	—	213	172	—	—	—	—	—	197	188	1	3.25	—	—
	240	55	58.7	65	1.5	261	834	750	1 150	51234	53234	53234U	237	173	200	250	91	180	21.5	212	198	1.5	8.12	7.69	9.83
	280	87	91.3	100	3	463	1 570	520	800	51334	53334	53334U	275	174	220	290	105	225	29	235	215	2.5	22.0	22.0	24.5
	340	135	—	—	5	755	2 730	360	550	51434	—	—	335	174	—	—	—	—	—	270	240	4	60.0	—	—
180	225	34	—	—	1.1	135	525	1 000	1 600	51136	—	—	222	183	—	—	—	—	—	207	198	1	3.39	—	—
	250	56	58.2	66	1.5	265	874	710	1 100	51236	53236	53236U	247	183	210	260	112	200	21.5	222	208	1.5	8.68	8.08	10.4
	300	95	99.3	109	3	463	1 580	490	750	51336	53336	53336U	295	184	240	310	91	225	32	251	229	2.5	28.1	26.9	29.9

[Remark] Standard cage types used for the above bearings are described earlier in this section.

Single direction thrust ball bearings

d (180) ~ 360 mm

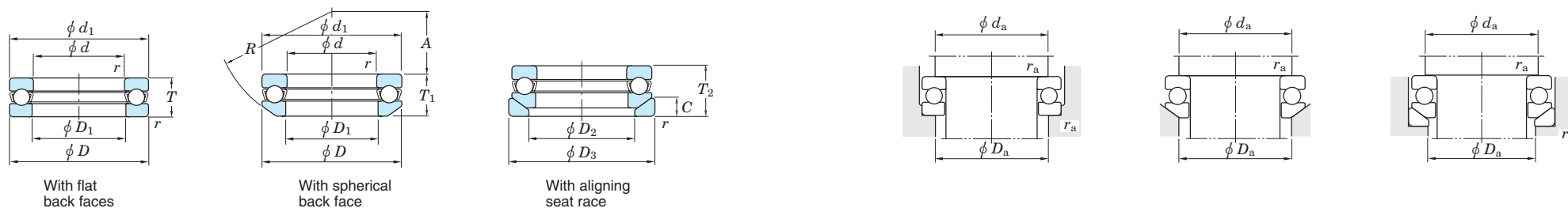

<i>d</i>	Boundary dimensions (mm)					Basic load ratings (kN)		Limiting speeds (min ⁻¹)		Bearing No.			Dimensions (mm)						Mounting dimensions (mm)			(Refer.) Mass (kg)			
	<i>D</i>	<i>T</i>	<i>T</i> ₁	<i>T</i> ₂	<i>r</i> _{min.}	<i>C</i> _a	<i>C</i> _{0a}	Grease lub.	Oil lub.	With flat back faces	With spherical back face	With aligning seat race	<i>d</i> ₁ max.	<i>D</i> ₁ min.	<i>D</i> ₂	<i>D</i> ₃	<i>A</i>	<i>R</i>	<i>C</i>	<i>d</i> _a min.	<i>D</i> _a max.	<i>r</i> _a max.	With flat back faces	With spherical back face	With aligning seat race
180	360	140	—	—	5	742	2 730	320	500	51436	—	—	355	184	—	—	—	—	—	286	254	4	69.5	—	—
	240	37	—	—	1.1	170	655	970	1 500	51138	—	—	237	193	—	—	—	—	—	220	210	1	3.95	—	—
	270	62	65.7	73	2	308	1 060	650	1 000	51238	53238	53238U	267	194	230	280	98	200	23	238	222	2	11.7	11.2	13.9
	320	105	111	121	4	543	1 950	440	680	51338	53338	53338U	315	195	255	330	104	250	33	266	244	3	36.0	36.3	39.7
200	250	37	—	—	1.1	172	675	940	1 450	51140	—	—	247	203	—	—	—	—	—	230	220	1	4.13	—	—
	280	62	65.3	74	2	314	1 110	620	950	51240	53240	53240U	277	204	240	290	125	225	23	248	232	2	12.2	11.6	14.8
	340	110	118.4	130	4	596	2 220	420	650	51340	53340	53340U	335	205	270	350	92	250	38	282	258	3	42.9	42.7	46.7
220	270	37	—	—	1.1	177	740	880	1 350	51144	—	—	267	223	—	—	—	—	—	250	240	1	4.50	—	—
	300	63	65.6	75	2	342	1 310	580	900	51244	53244	53244U	297	224	260	310	118	225	25	268	252	2	13.5	12.6	15.9
240	300	45	—	—	1.5	241	1 020	750	1 150	51148	—	—	297	243	—	—	—	—	—	276	264	1.5	7.38	—	—
	340	78	81.6	92	2.1	442	1 800	520	800	51248	53248	53248U	335	244	290	350	122	250	30	299	281	2	23.1	20.9	25.6
260	320	45	—	—	1.5	231	990	710	1 100	51152	—	—	317	263	—	—	—	—	—	296	284	1.5	7.93	—	—
	360	79	82.8	93	2.1	445	1 880	490	750	51252	53252	53252U	355	264	305	370	152	280	30	319	301	2	25.0	22.6	28.5
280	350	53	—	—	1.5	329	1 430	640	900	51156	—	—	347	283	—	—	—	—	—	322	308	1.5	12.0	—	—
300	380	62	—	—	2	363	1 610	540	810	51160	—	—	376	304	—	—	—	—	—	348	332	2	17.5	—	—
	420	95	100.5	112	3	570	2 600	400	600	51260	53260	53260U	415	304	360	430	164	320	34	371	349	2.5	42.5	39.5	48.0
320	400	63	—	—	2	379	1 760	540	810	51164	—	—	396	324	—	—	—	—	—	368	352	2	19.0	—	—
	440	95	100.5	112	3	577	2 710	400	600	51264	53264	53264U	435	325	380	450	157	320	36	391	369	2.5	45.0	42.0	52.0
340	420	64	—	—	2	387	1 860	500	770	51168	—	—	416	344	—	—	—	—	—	388	372	2	20.5	—	—
	460	96	100.3	113	3	584	2 830	380	570	51268	53268	53268U	455	345	400	470	199	360	36	411	389	2.5	48.0	45.0	55.0
360	440	65	—	—	2	394	1 960	500	720	51172	—	—	436	364	—	—	—	—	—	408	392	2	21.5	—	—
	500	110	116.7	130	4	701	3 500	340	500	51272	53272	53272U	495	365	430	510	172	360	43	443	417	3	70.0	65.0	82.0

[Remark] Standard cage types used for the above bearings are described earlier in this section.

Double direction thrust ball bearings

d_2 10 ~ (50) mm

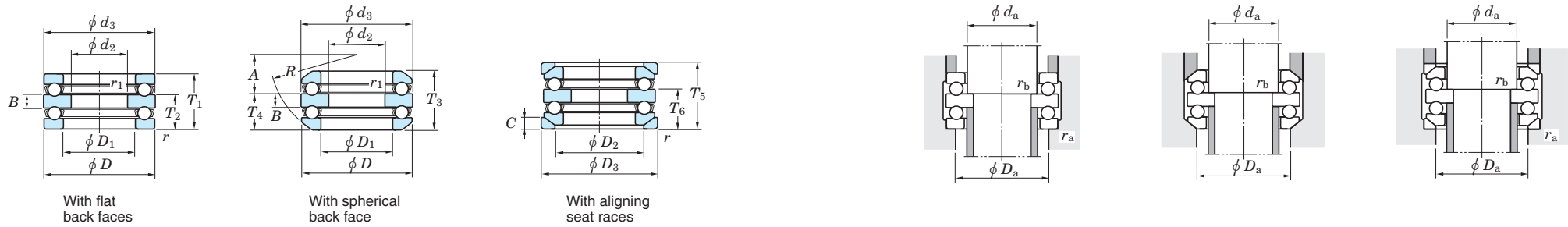

Boundary dimensions (mm)							Basic load ratings (kN)		Limiting speeds (min ⁻¹)		Bearing No.			Dimensions (mm)								Mounting dimensions (mm)				(Refer.) Mass (kg)				
d_2	D	T_1	T_3	T_5	$r_{min.}$	$r_{1 min.}$	C_a	C_{0a}	Grease lub.	Oil lub.	With flat back faces	With spherical back faces	With aligning seat races	d_3 max.	D_1 min.	D_2	D_3	T_2	T_4	T_6	A	R	B	C	d_a min.	D_a max.	r_a max.	r_b max.	With flat back faces	With aligning seat races
10	32	22	24.6	28	0.6	0.3	16.6	24.8	4 900	7 500	52202	54202	54202U	32	17	24	35	13.5	14.8	16.5	10.5	28	5	4	15	24	0.6	0.3	0.085	0.118
15	40	26	27.4	32	0.6	0.3	22.3	37.7	3 900	6 000	52204	54204	54204U	40	22	30	42	16	16.7	19	16	36	6	5	20	30	0.6	0.3	0.150	0.190
	60	45	49.8	55	1	0.6	55.6	89.4	2 600	4 000	52405	54405	54405U	60	27	42	62	28	30.4	33	15	50	11	8	25	42	1	0.6	0.630	0.804
20	47	28	31.4	36	0.6	0.3	27.7	50.4	3 600	5 500	52205	54205	54205U	47	27	36	50	17.5	19.2	21.5	16.5	40	7	5.5	25	36	0.6	0.3	0.230	0.304
	52	34	37.6	42	1	0.3	35.7	61.4	3 100	4 800	52305	54305	54305U	52	27	38	55	21	22.8	25	18	45	8	6	25	38	1	0.3	0.330	0.428
	70	52	56.2	62	1	0.6	72.8	126	2 200	3 400	52406	54406	54406U	70	32	50	75	32	34.1	37	16	56	12	9	30	50	1	0.6	1.00	1.25
25	52	29	32.6	37	0.6	0.3	28.1	54.3	3 400	5 200	52206	54206	54206U	52	32	42	55	18	19.8	22	20	45	7	5.5	30	42	0.6	0.3	0.270	0.346
	60	38	41.2	46	1	0.3	42.8	78.7	2 700	4 200	52306	54306	54306U	60	32	45	62	23.5	25.1	27.5	19.5	50	9	7	30	45	1	0.3	0.490	0.602
	80	59	63	69	1.1	0.6	87.1	155	1 900	2 900	52407	54407	54407U	80	37	58	85	36.5	38.5	41.5	18.5	64	14	10	35	58	1	0.6	1.44	1.79
30	62	34	37.8	42	1	0.3	40.7	83.8	2 900	4 500	52207	54207	54207U	62	37	48	65	21	22.9	25	21	50	8	7	35	48	1	0.3	0.420	0.544
	68	36	38.6	44	1	0.6	46.9	98.3	2 700	4 200	52208	54208	54208U	68	42	55	72	22.5	23.8	26.5	25	56	9	7	40	55	1	0.6	0.540	0.680
	68	44	47.2	52	1	0.3	55.5	105	2 400	3 700	52307	54307	54307U	68	37	52	72	27	28.6	31	21	56	10	7.5	35	52	1	0.3	0.710	0.898
	78	49	54	59	1	0.6	69.3	135	2 100	3 300	52308	54308	54308U	78	42	60	82	30.5	33	35.5	23.5	64	12	8.5	40	60	1	0.6	1.06	1.34
	90	65	69.4	77	1.1	0.6	113	205	1 700	2 600	52408	54408	54408U	90	42	65	95	40	42.2	46	22	72	15	12	40	65	1	0.6	2.03	2.55
35	73	37	39.6	45	1	0.6	47.7	105	2 600	4 000	52209	54209	54209U	73	47	60	78	23	24.3	27	23	56	9	7.5	45	60	1	0.6	0.620	0.784
	85	52	56.2	62	1	0.6	80.0	163	1 900	3 000	52309	54309	54309U	85	47	65	90	32	34.1	37	21	64	12	10	45	65	1	0.6	1.29	1.62
	100	72	78.8	86	1.1	0.6	130	242	1 500	2 300	52409	54409	54409U	100	47	72	105	44.5	47.9	51.5	23.5	80	17	12.5	45	72	1	0.6	2.91	3.42
40	78	39	42	47	1	0.6	48.5	111	2 300	3 600	52210	54210	54210U	78	52	62	82	24	25.5	28	30.5	64	9	7.5	50	62	1	0.6	0.710	0.890
	95	58	64.6	70	1.1	0.6	91.6	186	1 800	2 700	52310	54310	54310U	95	52	72	100	36	39.3	42	23	72	14	11	50	72	1	0.6	1.86	2.35
	110	78	83.2	92	1.5	0.6	148	283	1 400	2 100	52410	54410	54410U	110	52	80	115	48	50.6	55	30	90	18	14	50	80	1.5	0.6	3.56	4.39
45	90	45	49.6	55	1	0.6	69.4	159	2 100	3 200	52211	54211	54211U	90	57	72	95	27.5	29.8	32.5	32.5	72	10	9	55	72	1	0.6	1.12	1.44
	105	64	72.6	78	1.1	0.6	119	246	1 600	2 400	52311	54311	54311U	105	57	80	110	39.5	43.8	46.5	25.5	80	15	11.5	55	80	1	0.6	2.51	3.21
	120	87	92	101	1.5	0.6	178	359	1 200	1 900	52411	54411	54411U	120	57	88	125	53.5	56	60.5	22.5	90	20	15.5	55	88	1.5	0.6	4.70	5.62
50	95	46	50	56	1	0.6	73.6	179	1 900	3 000	52212	54212	54212U	95	62	78	100	28	30	33	30.5	72	10	9	60	78	1	0.6	1.25	1.57
	110	64	70.6	78	1.1	0.6	124	267	1 500	2 300	52312	54312	54312U	110	62	85	115	39.5	42.8	46.5	25.5	90	15	11.5	60	85	1	0.6	2.68	3.37
	130	93	99	107	1.5	0.6	201	397	1 100	1 700	52412	54412	54412U	130	62	95	135	57	60	64	28	100	21	16	60	95	1.5	0.6	6.33	7.60

[Remark] Standard cage types used for the above bearings are described earlier in this section.

Double direction thrust ball bearings

d_2 (50) ~ 95 mm

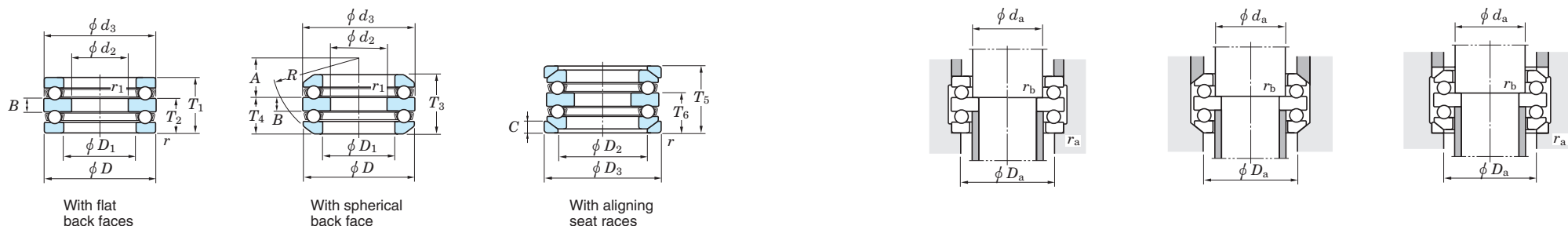

Boundary dimensions (mm)							Basic load ratings (kN)		Limiting speeds (min ⁻¹)		Bearing No.			Dimensions (mm)								Mounting dimensions (mm)				Mass (kg)						
d_2	D	T_1	T_3	T_5	r min.	r_1 min.	C_a	C_{0a}	Grease lub.	Oil lub.	With flat back faces	With spherical back faces	With aligning seat races	d_3 max.	D_1 min.	D_2	D_3	T_2	T_4	T_6	A	R	B	C	d_a min.	D_a max.	r_a max.	r_b max.	With flat back faces	With aligning seat races		
50	140	101	109.4	119	2	1	232	493	1 000	1 600	52413	54413	54413U	140	68	100	145	62	66.2	71	34	112	23	17.5	65	100	2	1	8.03	9.72		
55	100	47	50.4	57	1	0.6	74.8	189	1 900	2 900	52213	54213	54213U	100	67	82	105	28.5	30.2	33.5	38.5	80	10	9	65	82	1	0.6	1.36	1.70		
	105	47	50.6	57	1	1	73.6	189	1 800	2 800	52214	54214	54214U	105	72	88	110	28.5	30.3	33.5	36.5	80	10	9	70	88	1	1	1.48	1.84		
	115	65	71.8	79	1.1	0.6	128	287	1 400	2 200	52313	54313	54313U	115	67	90	120	40	43.4	47	34.5	90	15	12.5	65	90	1	0.6	2.90	3.66		
	125	72	80.4	88	1.1	1	148	339	1 300	2 000	52314	54314	54314U	125	72	98	130	44	48.2	52	39	100	16	13	70	98	1	1	3.90	4.78		
	150	107	114.2	125	2	1	250	553	940	1 450	52414	54414	54414U	150	73	110	155	65.5	69.1	74.5	28.5	112	24	19.5	70	110	2	1	9.71	11.6		
60	110	47	49.6	57	1	1	77.4	209	1 800	2 700	52215	54215	54215U	110	77	92	115	28.5	29.8	33.5	47.5	90	10	9.5	75	92	1	1	1.57	1.96		
	135	79	87.2	95	1.5	1	171	396	1 200	1 900	52315	54315	54315U	135	77	105	140	48.5	52.6	56.5	32.5	100	18	15	75	105	1.5	1	4.83	6.08		
	160	115	123	135	2	1	252	560	880	1 350	52415	54415	54415U	160	78	115	165	70.5	74.5	80.5	36.5	125	26	21	75	115	2	1	11.8	14.3		
65	115	48	51	58	1	1	78.5	218	1 700	2 600	52216	54216	54216U	115	82	98	120	29	30.5	34	45	90	10	10	80	98	1	1	1.69	2.09		
	140	79	86.2	95	1.5	1	176	424	1 200	1 800	52316	54316	54316U	140	82	110	145	48.5	52.1	56.5	45.5	112	18	15	80	110	1.5	1	5.06	6.36		
	170	120	128.4	140	2.1	1	270	621	810	1 250	52416	54416	54416U	170	83	125	175	73.5	77.7	83.5	30.5	125	27	22	80	125	2	1	14.0	16.6		
	180	128	138	150	2.1	1.1	307	753	780	1 200	52417	54417	54417U	179.5	88	130	185	78.5	83.5	89.5	40.5	140	29	23	85	130	2	1	17.5	19.7		
70	125	55	59.2	67	1	1	92.3	251	1 500	2 300	52217	54217	54217U	125	88	105	130	33.5	35.6	39.5	49.5	100	12	11	85	105	1	1	2.34	2.90		
	150	87	95.2	105	1.5	1	206	489	1 100	1 700	52317	54317	54317U	150	88	115	155	53	57.1	62	39	112	19	17.5	85	115	1.5	1	6.43	8.03		
	190	135	143.4	157	2.1	1.1	327	826	710	1 100	52418	54418	54418U	189.5	93	140	195	82.5	86.7	93.5	34.5	140	30	25.5	90	140	2	1	19.6	22.8		
75	135	62	69	76	1.1	1	117	326	1 400	2 100	52218	54218	54218U	135	93	110	140	38	41.5	45	42	100	14	13.5	90	110	1	1	3.22	4.07		
	155	88	97.2	106	1.5	1	213	524	1 000	1 600	52318	54318	54318U	155	93	120	160	53.5	58.1	62.5	36.5	112	19	18	90	120	1.5	1	6.60	8.44		
80	210	150	160	176	3	1.1	368	983	620	950	52420	54420	54420U	209.5	103	155	220	91.5	96.5	104.5	43.5	160	33	27	100	155	2.5	1	26.6	32.0		
85	150	67	72.8	81	1.1	1	147	410	1 200	1 900	52220	54220	54220U	150	103	125	155	41	43.9	48	49	112	15	14	100	125	1	1	4.29	5.25		
	170	97	105.4	115	1.5	1	236	596	940	1 450	52320	54320	54320U	170	103	135	175	59	63.2	68	42	125	21	18	100	135	1.5	1	8.90	10.8		
90	230	166	—	—	3	1.1	379	1 070	550	850	52422	—	—	229	113	—	—	101.5	—	—	—	—	37	—	110	170	2.5	1	34.9	—		
95	160	67	71.4	81	1.1	1	148	431	1 200	1 800	52222	54222	54222U	160	113	135	165	41	43.2	48	62	125	15	14	110	135	1	1	4.68	5.66		
	190	110	118.4	128	2	1	280	754	810	1 250	52322	54322	54322U	189.5	113	150	195	67	71.2	76	47	140	24	20.5	110	150	2	1	13.8	16.3		
	250	177	—	—	4	1.5	480	1 460	520	800	52424	—	—	249	123	—	—	108.5	—	—	—	—	40	—	120	185	3	1.5	44.2	—		

[Remark] Standard cage types used for the above bearings are described earlier in this section.

Double direction thrust ball bearings

d_2 100 ~ 190 mm

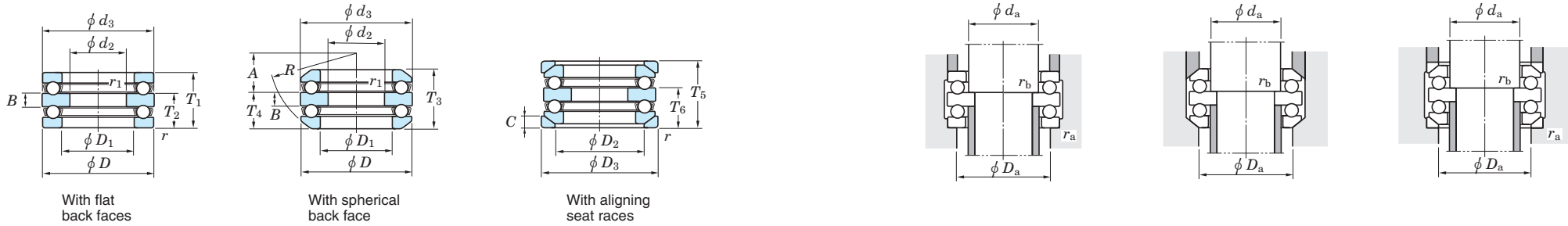

Boundary dimensions (mm)							Basic load ratings (kN)		Limiting speeds (min ⁻¹)		Bearing No.			Dimensions (mm)										Mounting dimensions (mm)				(Refer.) Mass (kg)		
d_2	D	T_1	T_3	T_5	$r_{\min.}$	$r_1_{\min.}$	C_a	C_{0a}	Grease lub.	Oil lub.	With flat back faces	With spherical back faces	With aligning seat races	$d_3_{\max.}$	$D_1_{\min.}$	D_2	D_3	T_2	T_4	T_6	A	R	B	C	$d_a_{\min.}$	$D_a_{\max.}$	$r_a_{\max.}$	$r_b_{\max.}$	With flat back faces	With aligning seat races
100	170	68	71.6	82	1.1	1.1	154	472	1 100	1 700	52224	54224	54224U	170	123	145	175	41.5	43.3	48.5	58.5	125	15	15	120	145	1	1	5.24	6.44
	210	123	131.2	143	2.1	1.1	325	931	710	1 100	52324	54324	54324U	209.5	123	165	220	75	79.1	85	58	160	27	22	120	165	2	1	17.2	22.9
	270	192	—	—	4	2	498	1 540	490	750	52426	—	—	269	134	—	—	117	—	—	—	—	42	—	130	200	3	2	56.5	—
110	190	80	85.8	96	1.5	1.1	203	622	970	1 500	52226	54226	54226U	189.5	133	160	195	49	51.9	57	63	140	18	17	130	160	1.5	1	7.72	9.29
	225	130	—	—	2.1	1.1	346	1 030	650	1 000	52326	—	—	224	134	—	—	80	—	—	—	—	30	—	130	177	2	1	22.1	—
	280	196	—	—	4	2	520	1 680	450	700	52428	—	—	279	144	—	—	120	—	—	—	—	44	—	140	206	3	2	60.6	—
120	200	81	86.2	99	1.5	1.1	215	669	940	1 450	52228	54228	54228U	199.5	143	170	210	49.5	52.1	58.5	83.5	160	18	17	140	170	1.5	1	8.31	10.5
	240	140	—	—	2.1	1.1	367	1 130	620	950	52328	—	—	239	144	—	—	85.5	—	—	—	—	31	—	140	190	2	1	27.8	—
	300	209	—	—	4	2	568	1 910	420	650	52430	—	—	299	154	—	—	127.5	—	—	—	—	46	—	150	225	3	2	73.9	—
130	215	89	95.6	109	1.5	1.1	244	768	840	1 300	52230	54230	54230U	214.5	153	180	225	54.5	57.8	64.5	74.5	160	20	20.5	150	180	1.5	1	10.6	13.6
	250	140	—	—	2.1	1.1	377	1 200	580	900	52330	—	—	249	154	—	—	85.5	—	—	—	—	31	—	150	200	2	1	29.2	—
	320	226	—	—	5	2	681	2 410	390	600	52432	—	—	319	164	—	—	138	—	—	—	—	50	—	160	240	4	2	90.3	—
135	340	236	—	—	5	2.1	755	2 730	360	550	52434	—	—	339	174	—	—	143	—	—	—	—	50	—	170	255	4	2	108	—
140	225	90	97.4	110	1.5	1.1	247	803	810	1 250	52232	54232	54232U	224.5	163	190	235	55	58.7	65	70	160	20	21	160	190	1.5	1	12.2	14.6
	270	153	—	—	3	1.1	470	1 570	550	850	52332	—	—	269	164	—	—	93	—	—	—	—	33	—	160	215	2.5	1	37.7	—
	360	245	—	—	5	3	742	2 730	320	500	52436	—	—	359	184	—	—	148.5	—	—	—	—	52	—	180	270	4	2.5	126	—
150	240	97	104.4	117	1.5	1.1	269	874	750	1 150	52234	54234	54234U	239.5	173	200	250	59	62.7	69	87	180	21	21.5	170	200	1.5	1	15.2	17.8
	250	98	102.4	118	1.5	2	294	986	710	1 100	52236	54236	54236U	249	183	210	260	59.5	61.7	69.5	108.5	200	21	21.5	180	210	1.5	2	15.9	19.6
	280	153	—	—	3	1.1	463	1 570	520	800	52334	—	—	279	174	—	—	93	—	—	—	—	33	—	170	220	2.5	1	39.6	—
	300	165	—	—	3	2	463	1 580	490	750	52336	—	—	299	184	—	—	101	—	—	—	—	37	—	180	240	2.5	2	50.9	—
160	270	109	116.4	131	2	2	298	1 010	650	1 000	52238	54238	54238U	269	194	220	280	66.5	70.2	77.5	93.5	200	24	23	190	230	2	2	21.6	25.2
	320	183	—	—	4	2	543	1 950	440	680	52338	—	—	319	195	—	—	111.5	—	—	—	—	40	—	190	255	3	2	64.9	—
170	280	109	115.6	133	2	2	314	1 110	620	950	52240	54240	54240U	279	204	240	290	66.5	69.8	78.5	120.5	225	24	23	200	240	2	2	22.7	27.3
	340	192	—	—	4	2	596	2 220	420	650	52340	—	—	339	205	—	—	117	—	—	—	—	42	—	200	270	3	2	77.8	—
190	300	110	115.2	134	2	2	342	1 310	580	900	52244	54244	54244U	299	224	260	310	67	69.6	79	114	225	24	25	220	260	2	2	23.9	29.5

[Remark] Standard cage types used for the above bearings are described earlier in this section.

Spherical thrust roller bearings

Spherical thrust roller bearings

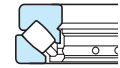

Bore diameter **60 – 500 mm**

Spherical thrust roller bearings are designed to carry high axial loads. They can also support radial load if magnitude is no more than 55 % of the axial load being carried.

These bearings are not suitable for high-speed rotation.

Having a spherical housing race raceway surface, these bearings are self-alignings, adjusting to axial inclination.

They are usually used with oil lubrication.



Boundary dimensions	As specified in JIS B 1512.
Tolerances	As specified in JIS B 1514-2, class 0. (refer to table 7-10 on p. A 69.)
Recommended fits	Refer to Table 9-8 on p. A 92.
Required minimum axial load	A certain degree of load is necessary in order for bearings to operate satisfactorily. (refer to p. A 110.)
Standard cage	Copper alloy machined cage (supplementary code : FY)
Allowable aligning angle	0.035 – 0.052 rad (2° – 3°) in general, depending on bearing series.
Equivalent axial load	Dynamic equivalent axial load $P_a = 1.2F_r + F_a$ Static equivalent axial load $P_{0a} \doteq 2.7F_r + F_a$ (Note : $F_r / F_a \leq 0.55$)

Spherical thrust roller bearings

d 60 ~ 160 mm

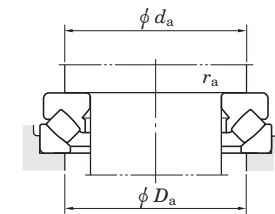
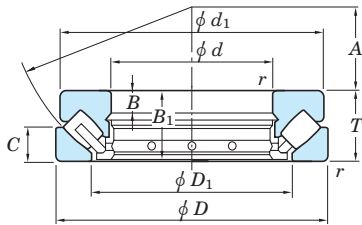

Boundary dimensions (mm)				Basic load ratings (kN)		Limiting speed (min ⁻¹)	Bearing No.	Dimensions (mm)						Mounting dimensions (mm)			(Refer.) Mass (kg)
d	D	T	$r_{min.}$	C_a	C_{0a}	Oil lub.		d_1	D_1	B	B_1	C	A	d_a min.	D_a max.	r_a max.	Mass
60	130	42	1.5	319	884	2 700	29412R	123	89	15	39.5	20	38	90	108	1.5	2.75
65	140	45	2	360	1 020	2 500	29413R	133	96	16	42.5	21	42	100	115	2	3.41
70	150	48	2	387	1 100	2 300	29414R	142	103	17	45.5	23	44	105	125	2	4.16
75	160	51	2	468	1 360	2 100	29415R	152	109	18	48	24	47	115	132	2	4.98
80	170	54	2.1	505	1 480	2 000	29416R	162	117	19	51	26	50	120	140	2	5.95
85	150	39	1.5	321	1 000	2 600	29317R 29417R	143.5	114	13	37	19	50	115	135	1.5	2.87
	180	58	2.1	572	1 700	1 900		170	125	21	55	28	54	130	150	2	7.19
90	155	39	1.5	330	1 050	2 500	29318R 29418R	148.5	117	13	37	19	52	120	140	1.5	3.06
	190	60	2.1	658	2 010	1 800		180	132	22	57	29	56	135	157	2	8.28
100	170	42	1.5	385	1 270	2 300	29320R 29420R	163	129	14	40	20.8	58	130	150	1.5	3.91
	210	67	3	730	2 220	1 650		200	146	24	64	32	62	150	175	2.5	11.2
110	190	48	2	502	1 690	2 000	29322R 29422R	182	143	16	45.5	23	64	145	165	2	5.67
	230	73	3	896	2 810	1 500		220	162	26	69	35	69	165	190	2.5	14.7
120	210	54	2.1	565	2 030	1 800	29324R 29424R	200	159	18	51	26	70	160	180	2	7.90
	250	78	4	1 040	3 270	1 350		236	174	29	74	37	74	180	205	3	18.5
130	225	58	2.1	715	2 440	1 700	29326R 29426R	215	171	19	55	28	76	170	195	2	9.45
	270	85	4	1 200	3 870	1 250		255	189	31	81	41	81	195	225	3	23.5
140	240	60	2.1	707	2 490	1 600	29328 29428R	230	183	20	57	29	82	185	205	2	11.1
	280	85	4	1 260	4 080	1 250		268	199	31	81	41	86	205	235	3	24.6
150	250	60	2.1	767	2 740	1 550	29330R 29430R	240	194	20	57	29	87	195	215	2	11.7
	300	90	4	1 380	4 620	1 100		285	214	32	86	44	92	220	250	3	29.6
160	270	67	3	862	3 070	1 400	29332 29432R	260	208	23	64	32	92	210	235	2.5	15.4
	320	95	5	1 590	5 370	1 050		306	229	34	91	45	99	230	265	4	35.9

Spherical thrust roller bearings

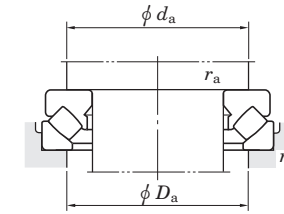
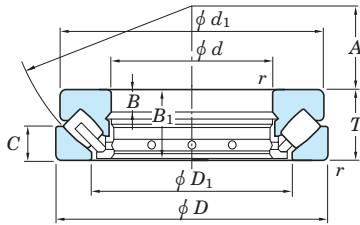
 d 170 ~ 320 mm

Boundary dimensions (mm)				Basic load ratings (kN)		Limiting speed (min ⁻¹)	Bearing No.	Dimensions (mm)						Mounting dimensions (mm)			(Refer.) Mass (kg)
d	D	T	r_{min}	C_a	C_{0a}	Oil lub.		d_1	D_1	B	B_1	C	A	d_a min.	D_a max.	r_a max.	
170	280	67	3	922	3 180	1 350	29334A 29434R	270	216	23	64	32	96	220	245	2.5	15.4
	340	103	5	1 740	5 880	950		324	243	37	99	50	104	245	285	4	44.0
180	300	73	3	896	3 170	1 250	29336 29436R	290	232	25	69	35	103	235	260	2.5	20.7
	360	109	5	1 960	6 590	900		342	255	39	105	52	110	260	300	4	52.2
190	320	78	4	1 170	4 230	1 150	29338 29438R	308	246	27	74	38	110	250	275	3	25.1
	380	115	5	2 230	7 690	850		360	271	41	111	55	117	275	320	4	61.4
200	280	48	2	513	2 170	1 600	29240 29340 29440R	271	236	15	45	24	108	235	255	2	8.90
	340	85	4	1 360	5 040	1 050		325	261	29	81	41	116	265	295	3	31.2
	400	122	5	2 460	8 470	800		380	286	43	117	59	122	290	335	4	73.0
220	300	48	2	536	2 340	1 550	29244 29344 29444R	292	254	15	45	24	117	260	275	2	10.0
	360	85	4	1 380	5 240	1 000		345	280	29	81	41	125	285	315	3	33.3
	420	122	6	2 540	8 990	750		400	308	43	117	58	132	310	355	5	74.2
240	340	60	2.1	822	3 670	1 250	29248 29348A 29448R	330	283	19	57	30	130	285	305	2	16.7
	380	85	4	1 430	5 330	950		365	300	29	81	41	135	300	330	3	35.5
	440	122	6	2 610	9 510	700		420	326	43	117	59	142	330	375	5	83.0
260	360	60	2.1	838	3 720	1 200	29252 29352 29452R	350	302	19	57	30	139	305	325	2	18.5
	420	95	5	1 540	6 040	850		405	329	32	91	45	148	330	365	4	51.5
	480	132	6	3 100	11 100	650		460	357	48	127	64	154	360	405	5	110
280	380	60	2.1	826	3 730	1 150	29256 29356 29456R	370	323	19	57	30	150	325	345	2	19.5
	440	95	5	1 760	6 870	800		423	348	32	91	46	158	350	390	4	53.2
	520	145	6	3 650	13 600	550		495	387	52	140	68	166	390	440	5	137
300	420	73	3	1 060	4 880	950	29260 29360 29460R	405	353	21	69	38	162	355	380	2.5	30.5
	480	109	5	1 970	7 780	700		460	379	37	105	50	168	380	420	4	74.9
	540	145	6	3 880	14 900	550		515	402	52	140	70	175	410	460	5	146
320	440	73	3	1 430	6 480	900	29264R 29364 29464R	430	372	21	69	38	172	375	400	2.5	32.7
	500	109	5	2 310	9 380	650		482	399	37	105	53	180	400	440	4	78.0
	580	155	7.5	4 160	16 100	500		555	435	55	149	75	191	435	495	6	179

Spherical thrust roller bearings

d 340 ~ 500 mm

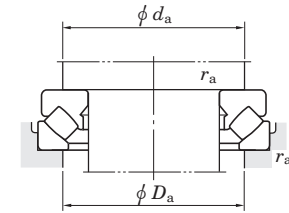
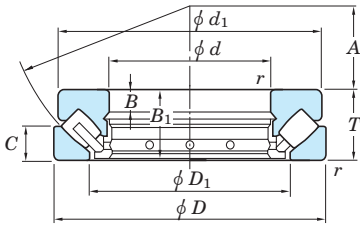

Boundary dimensions (mm)				Basic load ratings (kN)		Limiting speed (min ⁻¹)	Bearing No.	Dimensions (mm)						Mounting dimensions (mm)			(Refer.) Mass (kg)
d	D	T	$r_{min.}$	C_a	C_{0a}	Oil lub.		d_1	D_1	B	B_1	C	A	d_a min.	D_a max.	r_a max.	
340	460	73	3	1 390	6 420	900	29268R	445	395	21	69	37	183	395	420	2.5	34.7
	540	122	5	3 050	12 700	600	29368R	520	428	41	117	59	192	430	470	4	106
	620	170	7.5	4 960	19 400	450	29468R	590	462	61	164	82	201	465	530	6	224
360	500	85	4	1 310	6 080	750	29272	485	423	25	81	44	194	420	455	3	51.8
	560	122	5	3 120	13 200	550	29372R	540	448	41	117	59	202	450	495	4	110
	640	170	7.5	5 150	20 600	450	29472R	610	480	61	164	82	210	485	550	6	231
380	520	85	4	1 380	6 610	700	29276	505	441	27	81	42	202	440	475	3	52.8
	600	132	6	3 540	15 000	500	29376R	580	477	44	127	63	216	480	525	5	141
	670	175	7.5	5 420	22 000	410	29476R	640	504	63	168	85	230	510	575	6	263
400	540	85	4	1 580	7 610	700	29280	526	460	27	81	42	212	460	490	3	55.3
	620	132	6	3 700	16 100	500	29380R	596	494	44	127	64	225	500	550	5	144
	710	185	7.5	6 200	25 300	380	29480R	680	534	67	178	89	236	540	610	6	315
420	580	95	5	1 850	8 750	600	29284	564	489	30	91	46	225	490	525	4	75.4
	650	140	6	4 060	17 700	450	29384R	626	520	48	135	68	235	525	575	5	169
	730	185	7.5	6 380	26 500	370	29484R	700	556	67	178	89	244	560	630	6	330
440	600	95	5	1 870	8 970	600	29288	585	508	30	91	49	235	510	545	4	77.9
	680	145	6	4 290	18 800	420	29388R	655	548	49	140	70	245	550	600	5	190
	780	206	9.5	7 290	30 000	320	29488R	745	588	74	199	100	260	595	670	8	423
460	620	95	5	1 950	9 620	550	29292	605	530	30	91	46	245	530	570	4	81.0
	710	150	6	3 680	15 800	400	29392	685	567	51	144	72	257	575	630	5	216
	800	206	9.5	7 520	31 600	300	29492R	765	608	74	199	100	272	615	690	8	438
480	650	103	5	2 300	11 600	500	29296	635	556	33	99	55	259	555	595	4	89.0
	730	150	6	3 650	15 800	390	29396	705	590	51	144	72	270	595	650	5	218
	850	224	9.5	8 690	36 300	270	29496R	810	638	81	216	108	280	645	730	8	548
500	870	224	9.5	8 650	36 400	270	294/500R	830	661	81	216	107	290	670	750	8	562

Needle roller bearings

Needle roller bearings are small in sectional height, therefore useful in making machinery smaller and lighter. This type of bearing is used in a wide range of machinery, such as automobiles, motor cycles, electric machines, machine tools, aerospace and office equipment.

- Compact, highly rigid and superior in load carrying performance, compared with other types of bearings.
- Excellent for carrying oscillating loads; contains many small diameter rollers.
- Widely employed in stud type and yoke type track rollers used as guide rollers in cam mechanisms or linear motion units.
Also used in miniature one-way clutches in the clutch mechanisms of office equipment, such as copying machines.

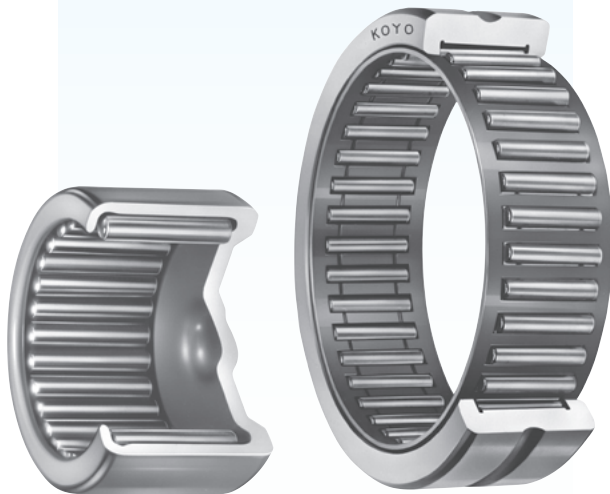

Needle roller and cage assemblies

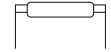

Bore diameter of a needle roller and cage assembly
6 – 95 mm

Drawn cup needle roller bearings

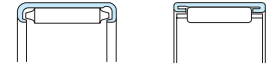

Full complement type With cage
Roller set bore diameter
4 – 50 mm

Machined ring needle roller bearings



Roller set bore diameter
12 – 160 mm

Needle roller thrust bearings

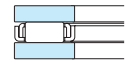

Bore diameter **10 – 100 mm**

Stud type track rollers (cam followers)

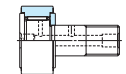

Outside diameter **13 – 90 mm**

Yoke type track rollers (roller followers)



Outside diameter **16 – 90 mm**

Miniature one-way clutches (Refer.)

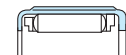

Roller set bore diameter **4 – 12 mm**

The catalog also covers bearings employing rollers other than those prescribed in JIS B 1506 "rollers for roller bearings".

Table 1 Types of needle roller bearing

	Needle roller and cage assemblies		Drawn cup needle roller bearings		Machined ring needle roller bearings		Needle roller thrust bearings	Stud type track rollers (cam followers)	Yoke type track rollers (roller followers)
	For general use	For use with connecting rods	With cage	Full complement type	Without inner ring	With inner ring			
Basic type		<ul style="list-style-type: none"> For use at large end (for crank pin) BE VE, VS...P <ul style="list-style-type: none"> For use at small end (for piston pin) RE, R...P, UR...P 	<ul style="list-style-type: none"> Open ends type BTM, BHTM, BT, BHT Closed end type MKM, MHKM, MK, MHK 	<ul style="list-style-type: none"> Open ends type BM, BHM, B, BH YM, Y Closed end type MM, M, MH 		<ul style="list-style-type: none"> Without inner ring RNA49, RNA59 NQ, NQS RNA69 <ul style="list-style-type: none"> With inner ring NA49, NA59 NQI, NQIS NA69 	<ul style="list-style-type: none"> Needle roller and cage assembly TV, TP Race* W, WS Combination type (separable type) TPW, TPWS, TPWWS One-piece (non-separable type) TPK..., TVK... 	<ul style="list-style-type: none"> Full complement type CM...M, CR...M CM...RM With cage KM...M KM...RM 	<ul style="list-style-type: none"> Full complement type CYM...M, CYM...RM With cage CXM...M, CXM...RM
Tolerances	<ul style="list-style-type: none"> The tolerances of needle roller are as specified in JIS B 1506. (refer to Table 2.) Cage width tolerance is given in Table 3. 		<ul style="list-style-type: none"> This type of bearing becomes accurate in terms of performance and dimensions when it is press-fit inside the housing at a specified interference. Therefore, its roller set bore diameter should be measured with the bearing press-fit inside a ring gauge. (refer to Tables 4 and 5.) 		<ul style="list-style-type: none"> As specified in JIS B 1536-1. (refer to Table 6 and 7.) 		<ul style="list-style-type: none"> The dimensional tolerance is given in Table 8 – 11. 	<ul style="list-style-type: none"> As specified in JIS B 1536 for the stud type track roller outer ring outside diameter and width tolerances, as well as the dimensional and running accuracy of yoke type track rollers. The tolerances of stud type track rollers are as shown in Table 12 – 14. The tolerances of yoke type track rollers are as shown in Table 15. 	
Recommended fits and radial internal clearance	Recommended fit is given in Table 16.	To be determined according to engine type and operating conditions.	Recommended fit is given in Table 17.		<ul style="list-style-type: none"> Recommended fit is as shown in Table 18. Radial internal clearance is as shown in Table 10-8 on p. A 100. For bearings which do not have an inner ring, the tolerance class of the roller set and roller complement bore diameters is F 6. Therefore, the radial internal clearance can be determined by choosing the shaft tolerance class. (refer to Table 19.) 		Recommended fit is as shown in Table 20.	Fix the stud type track rollers to the stud tightly so that there will be no play between them. Recommended mounting holes of stud are as shown in Table 21.	Recommended fit is as shown in Table 22.
Shaft and housing specifications	Table 23 gives the requirements for shafts and housings to which needle roller radial bearings are mounted. (for needle roller and cage assemblies used on connecting rods, refer to JTEKT separate catalog.)				As shown in Table 23.		Table 24 gives the specifications for the fitting face.		

[Remark] *-marked item indicates the thrust washer or washer specified in JIS.

[Tolerances of needle roller bearings]

Table 2 Tolerance grades of needle rollers (JIS B 1506)

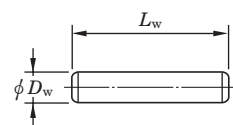

Unit : μm

Class	Single ¹⁾ plane diameter variation V_{Dwp} max.	Deviation ¹⁾ from circular form Δ_{Rw} max.	Gauge lot ¹⁾ diameter variation V_{DwL} max.
2	1	1	2
3	1.5	1.5	3
5	2	2.5	5

Class	Actual ²⁾ length deviation Δ_{Lws}	Recommended gauge S
2	h 13	0/- 2, - 1/- 3, - 2/- 4, - 3/- 5, - 4/- 6, - 5/- 7, - 6/- 8, - 7/- 9, - 8/- 10
3		0/- 3, - 1.5/- 4.5, - 3/- 6, - 4.5/- 7.5, - 6/- 9, - 7/- 10
5		0/- 5, - 3/- 8, - 5/- 10

[Notes] 1) Values apply only at middle of roller length.
2) Applied tolerance differs according to L_w division.

[Remark] Along the entire length of the roller, all the actually measured diameters should not exceed the actual maximum diameter at the middle of the entire length of the roller by the lengths shown below.
a) Class 2 : 0.5 μm b) Class 3 : 0.8 μm
c) Class 5 : 1 μm

Table 3 Tolerance of needle roller cage width B

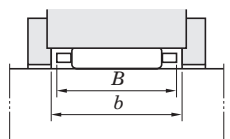

Bearing type	B deviation (mm)	
	upper	lower
R, RS, RP (Welded type), RV, V, VS, WR, WRS, WRP, WV	- 0.2	- 0.55
VP, VPS	- 0.2	- 0.7

[Remark] Values in Italic are prescribed in JTEKT standards.

[Reference] The guide width (b) should satisfy the equation : $b = B + x$ (x : 0.2 to 0 mm)

Table 4 Metric series drawn cup needle roller bearing inspecting gauge specifications

Unit : mm

Nominal bore diameter of rolling element complement F_w	Ring gauge	Plug gauge	
		Go end	No-go end
4	7.996	4.023	4.048
5	8.996	5.023	5.048
6	9.996	6.028	6.053
7	10.995	7.031	7.056
8	11.995 14.995	8.031	8.056
9	12.995 15.995	9.031	9.056
10	13.995 16.995	10.031	10.056
12	15.995 17.995 18.993	12.031	12.056
13	18.993	13.034	13.059
14	18.993 19.993 21.993	14.034	14.059
15	19.993 20.993 21.993	15.034	15.059
16	21.993 23.993	16.034	16.059
17	21.972 22.972 23.972	17.013	17.038
18	23.972 24.972	18.013	18.038
19	26.972	19.013	19.038
20	25.972 26.972	20.013	20.038
22	27.972 28.972 29.972	22.013	22.038
24	29.972 30.967 34.967	24.013	24.038
25	31.967 32.967	25.013	25.038
26	33.967	26.013	26.038
28	33.967 34.967 36.967	28.013	28.038
30	36.967 37.967 39.967	30.013	30.038
32	37.967 39.967 41.967	32.013	32.038
35	41.967 44.967	35.013	35.038
36	41.967 43.967 47.967	36.013	36.038
37	42.967 46.967	37.013	37.038
38	47.967	38.013	38.038
40	46.967 49.967	40.013	40.043
45	51.961 54.961	45.013	45.043
50	57.961 61.961	50.013	50.043
55	62.961	55.013	55.051

Table 5 Ring gauge specifications and roller set bore diameter tolerance (for bearings designed according to ISO standards)

Unit : mm

Nominal bore diameter of rolling element complement F_w	Nominal outside diameter D	Ring gauge	Nominal bore diameter of rolling element complement F_w tolerance	
			lower	upper
4	8	7.984	4.010	4.028
5	9	8.984	5.010	5.028
6	10	9.984	6.010	6.028
7	11	10.980	7.013	7.031
8	12 14	11.980 13.980	8.013	8.031
9	13 15	12.980 14.980	9.013	9.031
10	14 16	13.980 15.980	10.013	10.031
12	16 18	15.980 17.980	12.016	12.034
14	20 22	19.976 21.976	14.016	14.034
15	21 23	20.976 22.976	15.016	15.034
16	22 24	21.976 23.976	16.016	16.034
17	23 25	22.976 24.976	17.016	17.034
18	24 26	23.976 25.976	18.016	18.034
20	26 28	25.976 27.976	20.020	20.041
22	28 30	27.976 29.976	22.020	22.041
25	32 35	31.972 34.972	25.020	25.041
28	35 38	34.972 37.972	28.020	28.041
30	37 40	36.972 39.972	30.020	30.041
32	39 42	38.972 41.972	32.025	32.050
35	42 45	41.972 44.972	35.025	35.050
38	45 48	44.972 47.972	38.025	38.050
40	47 50	46.972 49.972	40.025	47.050
42	49 52	48.972 51.967	42.025	42.050
45	52 55	51.967 54.967	45.025	45.050
50	58	57.967	32.025	32.050
55	63	62.967	55.030	55.060
60	68	67.967	60.030	60.060
65	73	72.967	65.030	65.060
70	78	77.967	70.030	70.060

[Remark] The supplementary code "J" is added as a suffix to the bearing numbers that are designed according to ISO standards.

Table 6 Machined ring needle roller bearings variation of smallest single bore diameter of rolling element complement $F_{ws \min}$ ¹⁾ (for interchangeable bearings²⁾ and bearings without inner ring)

Unit : μm

Nominal bore diameter of rolling element complement F_w (mm)		$F_{ws \min}$ tolerance (F 6)	
over	up to	upper	lower
6	10	+ 22	+ 13
10	18	+ 27	+ 16
18	30	+ 33	+ 20
30	50	+ 41	+ 25
50	80	+ 49	+ 30
80	120	+ 58	+ 36
120	180	+ 68	+ 43
180	250	+ 79	+ 50

[Notes] 1) The smallest single bore diameter of rolling element complement is the diameter of a cylinder whose radial internal clearance disappears completely, at least in one radial direction.
2) A group of bearings with inner rings that have the same bearing number. Outer ring, cage and needle roller assemblies and inner rings are interchangeable among them.

Table 7 Radial bearing tolerances = JIS B 1536 =

(1) Inner ring

Unit : μm

Nominal bore diameter <i>d</i> (mm)		Single plane mean bore diameter deviation								Single plane bore diameter variation <i>V_{dsp}</i>				Mean bore diameter variation				Radial runout of assembled bearing inner ring <i>K_{ia}</i>				<i>S_d</i>				Single inner ring width deviation								Inner ring width variation				
		Δ_{dmp}								Diameter series 9																ΔB_s												
				class 0		class 6		class 5		class 4		class 0	class 6	class 5	class 4	class 0	class 6	class 5	class 4	class 0		class 6		class 5		class 4		class 0	class 6	class 5	class 4	class 0		class 6		class 5	class 4	
over	up to	upper	lower	upper	lower	upper	lower	upper	lower	max.				max.				max.		max.		upper	lower	upper	lower	upper	lower	upper	lower	max.								
2.5	10	0	-8	0	-7	0	-5	0	-4	10	9	5	4	6	5	3	2	10	6	4	2.5	7	3	0	-120	0	-120	0	-40	0	-40	15	15	5	2.5	1.5		
10	18	0	-8	0	-7	0	-5	0	-4	10	9	5	4	6	5	3	2	10	7	4	2.5	7	3	0	-120	0	-120	0	-80	0	-80	20	20	5	2.5	1.5		
18	30	0	-10	0	-8	0	-6	0	-5	13	10	6	5	8	6	3	2.5	13	8	4	3	8	4	0	-120	0	-120	0	-120	0	-120	20	20	5	2.5	1.5		
30	50	0	-12	0	-10	0	-8	0	-6	15	13	8	6	9	8	4	3	15	10	5	4	8	4	0	-120	0	-120	0	-120	0	-120	20	20	5	3	1.5		
50	80	0	-15	0	-12	0	-9	0	-7	19	15	9	7	11	9	5	3.5	19	10	5	4	8	5	0	-150	0	-150	0	-150	0	-150	25	25	6	4	1.5		
80	120	0	-20	0	-15	0	-10	0	-8	25	19	10	8	15	11	5	4	25	13	6	5	9	5	0	-200	0	-200	0	-200	0	-200	25	25	7	4	2.5		
120	150	0	-25	0	-18	0	-13	0	-10	31	23	13	10	19	14	7	5	31	18	8	6	10	6	0	-250	0	-250	0	-250	0	-250	30	30	8	5	2.5		
150	180	0	-25	0	-18	0	-13	0	-10	31	23	13	10	19	14	7	5	31	18	8	6	10	6	0	-250	0	-250	0	-250	0	-250	30	30	8	5	4		
180	250	0	-30	0	-22	0	-15	0	-12	38	28	15	12	23	17	8	6	38	20	10	8	11	7	0	-300	0	-300	0	-300	0	-300	30	30	10	6	5		

[Remark] Values in Italics are prescribed in JTEKT standards.

S_d : Perpendicularity of inner ring face with respect to the bore

(2) Outer ring

Unit : μm

Nominal outside diameter <i>D</i> (mm)		Single plane mean outside diameter deviation								Single plane outside diameter variation <i>V_{Dsp}</i>				Mean outside diameter variation				Radial runout of assembled bearing outer ring <i>K_{ea}</i>				<i>S_D</i>		ΔC_s	Ring width variation			
		Δ_{Dmp}								Diameter series 9															V_{Cs}			
				class 0		class 6		class 5		class 4		class 0 ¹⁾	class 6 ¹⁾	class 5	class 4	class 0 ¹⁾	class 6 ¹⁾	class 5	class 4	class 0, 6, 5, 4		class 0	class 6	class 5	class 4	max.		
6	18	0	-8	0	-7	0	-5	0	-4	10	9	5	4	6	5	3	2	15	8	5	3	8	4	Shall conform to the tolerance ΔB_s on <i>d</i> of the same bearing	Shall conform to the tolerance <i>V_{Bs}</i> on <i>d</i> of the same bearing	5	2.5	
18	30	0	-9	0	-8	0	-6	0	-5	12	10	6	5	7	6	3	2.5	15	9	6	4	8	4			5	2.5	
30	50	0	-11	0	-9	0	-7	0	-6	14	11	7	6	8	7	4	3	20	10	7	5	8	4			5	2.5	
50	80	0	-13	0	-11	0	-9	0	-7	16	14	9	7	10	8	5	3.5	25	13	8	5	8	4			6	3	
80	120	0	-15	0	-13	0	-10	0	-8	19	16	10	8	11	10	5	4	35	18	10	6	9	5			8	4	
120	150	0	-18	0	-15	0	-11	0	-9	23	19	11	9	14	11	6	5	40	20	11	7	10	5			8	5	
150	180	0	-25	0	-18	0	-13	0	-10	31	23	13	10	19	14	7	5	45	23	13	8	10	5	8	5			
180	250	0	-30	0	-20	0	-15	0	-11	38	25	15	11	23	15	8	6	50	25	15	10	11	7	10	7			
250	315	0	-35	0	-25	0	-18	0	-13	44	31	18	13	26	19	9	7	60	30	18	11	13	8	11	7			

[Note] 1) Shall be applied when locating snap ring is not fitted.

[Remark] Values in Italics are prescribed in JTEKT standards.

S_D : Perpendicularity of outer ring outside surface with respect to the face

ΔC_s : Deviation of a single outer ring width

Table 8 Tolerances for needle roller and cage thrust assemblies (type code : TV, TP) = JIS B 1536 =

(1) Bore diameter					(2) Outside diameter				
Unit : μm					Unit : μm				
Cage bore diameter		Smallest single bore ($d_{cs\ min}$) diameter tolerance ¹⁾		Single plane bore diameter variation $V_{d_{esp}}$	Cage outside diameter		Largest single outside ($D_{cs\ max}$) diameter tolerance ¹⁾		Single plane outside diameter variation $V_{D_{dsp}}$
d_c (mm)					D_c (mm)				
over	up to	upper	lower	max.	over	up to	upper	lower	max.
6	10	+115	+25	90	18	30	-110	-320	210
10	18	+142	+32	110	30	40	-120	-370	250
18	30	+170	+40	130	40	50	-130	-380	250
30	50	+210	+50	160	50	65	-140	-440	300
50	80	+250	+60	190	65	80	-150	-450	300
80	120	+292	+72	220	80	100	-170	-520	350
					100	120	-180	-530	350
					120	140	-200	-600	400

[Note] 1) The tolerances indicate the limits of differences between $d_{cs\ min}$ and d_c .
 [Remark] The tolerances of thickness conform to JIS B 1506 in a similar manner to roller diameter (D_w) (refer to page B 378).
 [Note] 1) The tolerances indicate the limits of differences between $D_{cs\ max}$ and D_c .
 [Remark] The tolerances of thickness conform to JIS B 1506 in a similar manner to roller diameter (D_w) (refer to page B 378).

Table 9 Tolerances for races = JIS B 1536 = (Indicates the thrust washer specified in JIS)

(1) Bore diameter (type code : W)					(2) Outside diameter (type code : W)				
Unit : μm					Unit : μm				
Race bore diameter		Smallest single bore ($d_{s\ min}$) diameter tolerance ¹⁾		Single plane bore diameter variation V_{dsp}	Race outside diameter		Largest single outside ($D_{s\ max}$) diameter tolerance ¹⁾		Single plane outside diameter variation $V_{D_{dsp}}$
d (mm)					D (mm)				
over	up to	upper	lower	max.	over	up to	upper	lower	max.
6	10	+175	+25	120	18	30	-40	-250	330
10	18	+212	+32	180	30	50	-50	-300	390
18	30	+250	+40	210	50	80	-60	-360	460
30	50	+300	+50	250	80	120	-72	-422	540
50	80	+360	+60	300	120	180	-85	-485	630
80	120	+422	+72	350					

[Note] 1) The tolerances indicate the limits of differences between $d_{s\ min}$ and d .
 [Remark] Tolerances of thickness (S) shall be equivalent to tolerance class js12 of JIS B 0401-2.

Table 10 Tolerances for races (Indicates the washer specified in JIS)

(1) Bore diameter (type code : WS)					(2) Outside diameter (type code : WS)				
Unit : μm					Unit : μm				
Race bore diameter		Smallest single bore ($d_{s\ min}$) diameter tolerance ¹⁾		Single plane bore diameter variation V_{dsp}	Race outside diameter		Largest single outside ($D_{s\ max}$) diameter tolerance ¹⁾		Single plane outside diameter variation $V_{D_{dsp}}$
d (mm)					D (mm)				
over	up to	upper	lower	max.	over	up to	upper	lower	max.
6	10	+175	+25	120	18	30	-40	-250	330
10	18	+212	+32	180	30	50	-50	-300	390
18	30	+250	+40	210	50	80	-60	-360	460
30	50	+300	+50	250	80	120	-72	-422	540
50	80	+360	+60	300	120	180	-85	-485	630
80	120	+422	+72	350					

[Note] 1) The tolerances indicate the limits of differences between $d_{s\ min}$ and d .
 [Remarks] 1. Tolerances of thickness (S) shall be equivalent to tolerance class js12 of JIS B 0401-2.
 2. Values in Italics are prescribed in JTEKT standards.

Table 11 Tolerances for non-separable needle roller thrust bearings (type code : TVK, TPK)

(1) Bore diameter					(2) Outside diameter				
Unit : μm					Unit : μm				
Race bore diameter		Smallest single bore ($d_{s\ min}$) diameter tolerance ¹⁾		Single plane bore diameter variation V_{dsp}	Race outside diameter		Largest single outside ($D_{s\ max}$) diameter tolerance ¹⁾		Single plane outside diameter variation $V_{D_{dsp}}$
d (mm)					D (mm)				
over	up to	upper	lower	max.	over	up to	upper	lower	max.
18	30	+250	+40	210	30	50	-50	-300	250
30	50	+300	+50	250	50	80	-60	-360	300
50	80	+360	+60	300	80	120	-72	-422	350

[Note] 1) The tolerances indicate the limits of differences between $d_{s\ min}$ and d .
 [Remark] Values in Italics are prescribed in JTEKT standards.
 [Note] 1) The tolerances indicate the limits of differences between $D_{s\ max}$ and D .
 [Remark] Values in Italics are prescribed in JTEKT standards.

Table 12 Outer ring tolerance of stud type track rollers (cam followers) = JIS B 1536 =

(1) Metric series								Unit : μm
Nominal outside diameter D (mm)	Single plane mean outside diameter deviation ΔD_{mp}				Single outer ring width deviation ΔC_s		Radial runout of assembled bearing outer ring K_{ea}	
	Cylindrical outside surface		Crowning outside surface		upper	lower		
over	up to	upper	lower	upper	lower	upper	lower	max.
10	18	0	-8	0	-50	0	-120	15
18	30	0	-9	0	-50	0	-120	15
30	50	0	-11	0	-50	0	-120	20
50	80	0	-13	0	-50	0	-120	25
80	120	0	-15	0	-50	0	-120	35

[Remark] Values in Italics are prescribed in JTEKT standards.

Table 13 Tolerances of shank diameter

(1) Metric series				Unit : μm
Shank diameter d_1 (mm)		Deviation of a single shank diameter Δd_{1s}		
over	up to	upper	lower	
3	6	0	-12	
6	10	0	-15	
10	18	0	-18	
18	30	0	-21	

Table 14 Tolerances of shank length

Shank length B_2 (mm)	Deviation of a single shank length ΔB_{2s}	
	upper	lower
Total dimensions	+0.8	-0.8

[Remark] Values in Italics are prescribed in JTEKT standards.

Table 15 Tolerances of yoke type track rollers (metric series) = JIS B 1536 =

(1) Inner ring						(2) Outer ring								
Unit : μm						Unit : μm								
Nominal bore diameter d (mm)	Single plane mean bore diameter deviation Δd_{mp}				Single inner ring width deviation ΔB_s		Nominal outside diameter D (mm)	Single plane mean outside diameter deviation ΔD_{mp}				Single outer ring width deviation ΔC_s	Radial runout of assembled bearing outer ring K_{ea}	
	Cylindrical outside surface		Crowning outside surface		upper	lower		Cylindrical outside surface		Crowning outside surface				
over	up to	upper	lower	upper	lower	over	up to	upper	lower	upper	lower	upper	lower	max.
2.5	10	0	-8	0	-180	10	18	0	-8	0	-50	0	-120	15
10	18	0	-8	0	-210	18	30	0	-9	0	-50	0	-120	15
18	30	0	-10	0	-210	30	50	0	-11	0	-50	0	-120	20
30	50	0	-12	0	-250	50	80	0	-13	0	-50	0	-120	25
						80	120	0	-15	0	-50	0	-120	35

[Remark] Values in Italics are prescribed in JTEKT standards.

[Remark] Values in Italics are prescribed in JTEKT standards.

[Recommended fit and internal clearance]

Table 16 Recommended fit for needle roller and cage assemblies

Conditions	Tolerance class		Housing bore
	Shaft		
	$F_w \leq 50\text{mm}$	$F_w > 50\text{mm}$	
High accuracy, impact load, oscillating motion	js 5	h 5	G 6
General	h 5	g 5	
High temperature, large shaft deflection, large misalignment	f 6		

Table 17 Recommended fit for drawn cup needle roller bearings

Distinction	Tolerance class		
	Shaft	Housing bore	
		Steel or cast iron	Light alloy, or steel or cast iron of 6 mm or less in thickness
Inner ring rotation	h 6	N 7	R 7 or S 7
Outer ring rotation	f 6	R 7	

[Remarks] 1. When the shaft makes oscillatory motions, the shaft diameter should be 0.013 mm larger than the recommended tolerance.
 2. When the bearing is provided with an inner ring, the shaft tolerance class j 6 should be selected.

Table 19 Relation between tolerance class of a shaft provided with a machined ring needle roller bearing (without inner ring) and radial internal clearance

Roller set/roller complement bore diameter (mm)	C 2	C N	C 3	C 4
Over 3 up to 180	k 5	h 5	f 6	e 6

Table 18 Recommended fit for machined ring needle roller bearings

(1) Recommended fits of inner ring and shaft

Operating condition		Shaft diameter (mm)	Class of shaft tolerance range	Applications (for reference)
Stationary inner ring load	Inner ring needs to move smoothly on shaft.	All shaft diameters	g 6	Stationary shaft wheels, tension pulleys, rope sheaves etc.
	Inner ring does not need to move smoothly on shaft.		h 6	
	High accuracy or noiseless rotation is required.		h 5	
Rotating inner ring load	Light load	40 mm or less	js 6	Electric appliances, machine tools, pumps, blowers, carriers etc.
	Normal load	40 mm or less	k 5	Electric motors, turbines, internal combustion engines, wood-working machines etc.
		over 40 100 mm or less	m 5	
		over 100 mm	m 6	
Heavy load or impact load	140 mm or less	n 6	Railway rolling stock axle journals, traction motors	
	over 140 mm	p 6		

(2) Recommended fits of the outer ring and housing

Operating condition		Class of housing bore tolerance range	Applications (for reference)
Rotating outer ring load	Heavy load with shock	P 7	Fly wheels
	Normal load	N 7	Loose wheels, crank shaft, gears
	Light fluctuating load	M 7	Rope pulley, jockey puller
Extreme impact load	Eccentric pump wheel		
Indeterminate direction load	Normal load	K 7	Compressor
	Light load	J 7	Compressor, crank shaft
Stationary outer ring load	Split housing, normal load	H 7	General use
	High accuracy and rigidity are required	K 6	Machine tool spindle

[Notes] 1) This table is applicable to cast iron or steel housing. For light alloy housings, somewhat more interference fits than shown are recommended.
 2) Interference fits larger than J 7 should not be used in split housings.

Table 20 Recommended fit for needle roller thrust bearings

Distinction	Type code	Guide	Tolerance class	
			Shaft	Housing bore
Needle roller and cage thrust assembly	TV TP	Inside	h 8	-
		Outside	-	H 8
Race ^{1) 2)}	W WS	Inside	h 8	-
		Outside	-	H 8
Non-separable bearing	TVK (TPK) ...JL TVK (TPK) ...J TVK (TPK) ...L	Inside	h 8	-
		Outside	-	H 8

[Notes] 1) Type code W indicates the thrust washer specified in JIS.
 2) Type code WS indicates the washer specified in JIS.

[Remark] This tolerance class is applicable when the tolerances of bore and outside diameters of bearings are standard.

Table 21 Tolerances for stud fitting bore

Bearing type	Tolerance class
CM, KM	H 7

Table 22 Recommended fit for yoke type track rollers (roller followers)

Degree of loading	Shaft tolerance class
Light or medium load	g 6 or h 6
Heavy load	k 6

[Remark] Because yoke type track rollers (roller followers) are generally used with the outer ring rotation, they should be attached to the shaft by transition fitting or clearance fitting. If the application involves heavy loading, the shaft should be hardened and the track roller should be attached by interference fitting.

[Shaft and housing specifications]

Table 23 Specifications of needle roller bearing shafts and housings				
Item	Shaft		Housing bore	
	Raceway surface	Fitting surface	Raceway surface	Fitting surface
Roundness	Best if less than one half or one third of the shaft diameter tolerance		Best if less than one half or one third of the bore diameter tolerance	
Cylindricity	5 μm or less per 25 mm, or one half or less of the shaft diameter tolerance		5 μm or less per 25 mm, or one half or less of the bore diameter tolerance	
Roughness (Ra)	0.4 a or less	0.8 a or less	0.6 a or less	1.6 a or less
Hardness	58 HRC or harder ¹⁾ (60 to 64 HRC are best.)	—	58 HRC or harder ¹⁾ (60 to 64 HRC are best.)	—

[Note] 1) Case hardened steel which is carburized or induction-hardened should not only meet the surface hardness requirement specified above but also have a case depth of 52.3 HRC (550 HV) to a depth in the range $(0.08 \text{ to } 0.1) \times D_w$ mm. (D_w : roller diameter)
In general, 30 thru 45 HRC is best for the center hardness.



Table 24 Needle roller thrust bearing mounting surface specifications	
Squareness	 25 μm or less per 25 mm
	 12.5 μm or less per 25 mm
Roughness (Ra)	0.4 a or less
Hardness	58 HRC or harder (60 thru 64 HRC is best.) (refer to the note for Table 23 above regarding depth.)

Table 25 Track capacity of stud type and yoke type track rollers (cam and roller followers)		
<ul style="list-style-type: none"> Track capacity is the maximum load receivable without deformation or indentation of track surfaces contacted by the outer rings of track rollers to allow the track to be used continuously. The values in the specification table are track capacities obtained using track rollers with cylindrical outside surfaces made of HRC 40 steel. Track capacity of the type track rollers with spherical outside surface is 80% of the values listed in the specification table. To obtain track capacity for hardness out of standard, multiply the track capacities by track capacity coefficient listed in the table at right. 	Hardness (HRC)	Track capacity coefficient
	26	0.48
	32	0.64
	36	0.79
	40	1
	44	1.31
	47	1.59
	50	1.99
	53	2.43
	56	2.90
58	3.23	

Needle roller and cage assemblies

F_w 9 ~ (15) mm

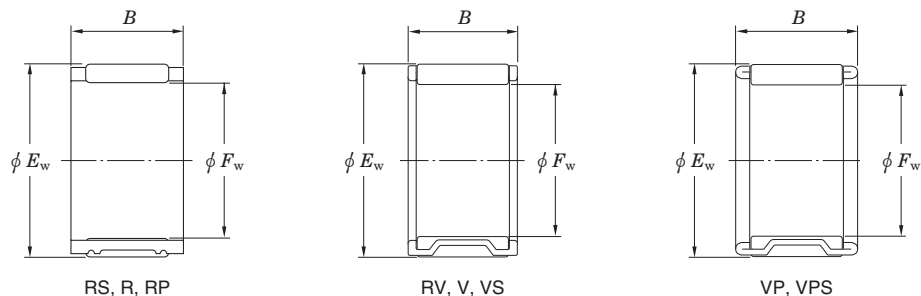

F_w (15) ~ (20) mm

ϕE_w : Roller set outside diameter
 ϕF_w : Roller set bore diameter

Boundary dimensions (mm)			Basic load ratings (kN)		Limiting speeds (min ⁻¹) Oil lub.	Bearing No.	Special series (Cage)	(Refer.) Mass (g)
<i>F_w</i>	<i>E_w</i>	<i>B</i>	<i>C_r</i>	<i>C_{0r}</i>				
9	12	10	3.8	4.0	43 000	RS091210 RF091418	— Polyamide	2.9 5.3
	14	18	9.1	9.0	41 000			
10	13	13	5.8	7.0	41 000	R10/13 RF101320 RS10/8-1	— Polyamide —	4.0 2.4 3.5
	14	8	4.5	4.3	40 000			
	14	10	5.1	5.0	40 000			
	14	13	7.0	7.4	40 000	RS10/10 RS10/13 RP101518	— — Welded	4.3 5.5 7.8
	15	18	10.5	10.9	37 000			
	12	15	13	6.3	8.2	36 000	R12/13 12R1620A RV121712A-2	— — —
16		20	9.5	11.5	35 000			
17		11.5	8.2	8.3	34 000			
13	17	10	5.9	6.4	33 000	RS131710-2 RS131712 13R1815	— — —	5.5 6.5 10
	17	12	7.3	8.4	33 000			
	18	15	10.2	11.2	32 000			
14	18	10	5.8	6.5	31 000	RS141810Q2 RS141815 R14/17A RV141909P1 RS141918	— — — — —	6.0 8.5 10 5.7 13
	18	15	9.6	12.3	31 000			
	18	17	10.1	13.2	31 000			
	19	9	7.0	7.1	30 000			
	19	18	12.3	14.6	30 000			
15	19	7.8	4.7	5.0	29 000	RS151908A R15/10-1 R15/13 R15/17 R15/20 VS15/13 RS15/18A VS15/20	— — — — — — — —	5.0 6.1 7.9 10 12 8.6 14 12
	19	10	6.3	7.2	29 000			
	19	13	8.7	10.9	29 000			
	19	17	10.5	14.0	29 000			
	19	20	12.6	17.7	29 000			
	20	13	10.4	11.9	29 000			
	20	18	13.8	17.2	29 000			
	20	20	16.2	21.2	29 000			

Boundary dimensions (mm)			Basic load ratings (kN)		Limiting speeds (min ⁻¹) Oil lub.	Bearing No.	Special series (Cage)	(Refer.) Mass (g)				
<i>F_w</i>	<i>E_w</i>	<i>B</i>	<i>C_r</i>	<i>C_{0r}</i>								
15	21	9	7.4	6.9	28 000	RV152109-4 RS152117	— —	7.8 16				
	21	17	13.4	14.8	28 000							
16	20	13	9.4	12.5	28 000	R16/13 16VP2126 16VS2212-2 RS16/24 VPS16/28A	Width tolerance special ¹⁾ Width tolerance special ¹⁾ — Width tolerance special ¹⁾ —	8.5 16 11 23 24				
	21	26	19.9	28.0	27 000							
	22	12	9.6	9.6	26 000							
	22	24	20.4	25.6	26 000							
	22	28.4	21.7	27.9	26 000							
17	20	6	3.1	3.6	27 000	RF172006 RF172008A-2 R17/10 R17/13 R17/15 RS172117 17R2220 RS17/13	With single split polyamide With single split polyamide — — — — — —	1.3 1.7 6.8 8.8 10 11 17 14				
	20	8	3.8	4.7	27 000							
	21	10	6.8	8.3	26 000							
	21	13	9.4	12.6	26 000							
	21	15	10.7	15.0	26 000							
	21	17	11.3	16.1	26 000							
	22	20	15.2	20.2	26 000							
	23	13	11.4	12.4	25 000							
	18	22	13	9.5	13.1				25 000	R18/13 R18/16-8 R18/17 RS182417 RP182517 RF182622A-1 RV182622A-2	— — — Width tolerance special ¹⁾ Welded Polyamide —	9.2 11 12 19 19 19 31
		22	16	11.1	16.0				25 000			
22		17	11.9	17.4	25 000							
24		17	15.1	17.9	24 000							
25		17	17.8	20.1	23 000							
26		21.9	19.1	20.3	23 000							
26		21.9	22.7	25.5	23 000							
19		24	22	16.6	23.3	23 000	RS192422	— —	21 21			
	24	22	16.6	23.3	23 000							
20	24	10	7.2	9.4	23 000	R20/10 R20/13P RF202525	— — Polyamide	7.9 10 14				
	24	13	9.8	14.0	23 000							
	25	25	18.8	27.9	22 000							

[Note] 1) For further information, consult with JTEKT.

[Remark] Limiting speed of grease lubrication should be kept to under 60 % of that for oil lubrication.

Needle roller and cage assemblies

F_W (20) ~ (22) mm

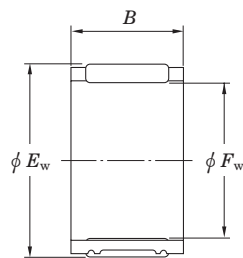

RS, R, RP

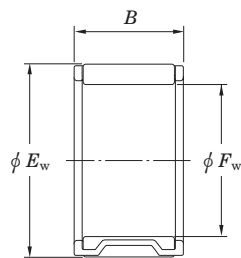

RV, V, VS

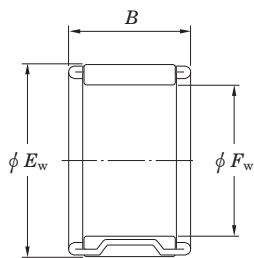

VP, VPS

F_W (22) ~ (25) mm

ϕE_w : Roller set outside diameter

ϕF_w : Roller set bore diameter

Boundary dimensions (mm)			Basic load ratings (kN)		Limiting speeds (min ⁻¹) Oil lub.	Bearing No.	Special series (Cage)	(Refer.) Mass (g)
F _w	E _w	B	C _r	C _{0r}				
20	26	11.6	10.7	11.9	22 000	20VS2612	Width tolerance special ¹⁾	12
	26	12	12.8	15.1	22 000	RV202612-4	—	14
	26	14	14.1	17.0	22 000	VS20/14A	—	15
	26	17	15.8	19.6	22 000	RS20/17	—	21
	26	18.8	17.4	22.3	22 000	RP202619A	—	17
	26	20	18.9	24.7	22 000	VP20/20-1	Width tolerance special ¹⁾	19
	26	30	26.8	38.9	22 000	RS202630	Welded	39
	27	15	16.2	18.3	21 000	20V2715	—	19
	27	29	25.4	32.6	21 000	20V2729	—	37
	28	20	24.1	28.2	21 000	RP202820	—	28
	28	25	28.8	35.4	21 000	20V2825B	—	37
	30	15	18.2	17.1	20 000	RV203015	—	30
	21	29	22.5	23.7	27.6	20 000	RF212923A	Polyamide
22	26	12	9.6	14.1	21 000	RS222612	—	10
	26	13	10.4	15.6	21 000	R22/13-1	—	11
	26	17	13.0	20.7	21 000	R22/17	—	14
	27	20	17.0	25.2	20 000	RS222720	—	21
	28	11	9.5	10.5	20 000	RS222811	—	15
	28	14	13.2	15.9	20 000	22VS2814E	—	16
	28	17	16.1	20.7	20 000	RS22/17	—	22
	28	22.5	21.3	29.6	20 000	RP222823A	Welded, Width tolerance special ¹⁾	25
	28	23	24.2	35.1	20 000	VS22/23B	Width tolerance special ¹⁾	25
	29	17	17.0	20.0	20 000	RV222917	—	23
	30	15	16.7	17.9	19 000	RV223015	—	25
	30	18	21.8	25.2	19 000	RV223018	—	30
	30	20	24.1	28.8	19 000	RV223020-1	—	31
	32	15	21.1	21.3	19 000	RV223215	—	32
	32	16	21.1	21.3	19 000	RV223216	—	35

[Note] 1) For further information, consult with JTEKT.

[Remark] Limiting speed of grease lubrication should be kept to under 60 % of that for oil lubrication.

Boundary dimensions (mm)			Basic load ratings (kN)		Limiting speeds (min ⁻¹) Oil lub.	Bearing No.	Special series (Cage)	(Refer.) Mass (g)
F _w	E _w	B	C _r	C _{0r}				
22	32	30	40.4	48.9	19 000	RV223230	—	62
23	29	30	26.0	39.0	19 000	23V2930	Width tolerance special ¹⁾	35
	30	15	17.4	21.0	19 000	RV233015	—	21
	33	20	27.0	29.4	18 000	23V3320-1	Width tolerance special ¹⁾	44
24	28	13	11.1	17.4	19 000	RS242813	—	12
	28	17	13.7	22.8	19 000	R24/17A	—	16
	28	23	18.2	32.9	19 000	RS242823	—	21
	32	15	20.0	23.2	18 000	RV243215-4	—	27
25	29	9.9	7.1	9.8	19 000	R25/10A	Width tolerance special ¹⁾	10
	29	13	11.5	18.4	19 000	R25/13-1	—	13
	30	9.9	9.3	12.0	18 000	25R3010A	Width tolerance special ¹⁾	13
	30	12	10.5	14.1	18 000	25R3012	—	15
	30	17	15.7	23.6	18 000	25V3017	—	18
	30	20	19.0	30.1	18 000	25R3020-1	—	24
	30	20	16.6	25.3	18 000	25VPU3020B	Double split	16
	31	17.5	17.4	23.8	18 000	VPS25/18	—	18
	31	18	17.4	23.8	18 000	RS25/18	—	27
	31	20	21.0	30.5	18 000	VS25/20	Width tolerance special ¹⁾	26
	31	24	24.9	37.8	18 000	25R3124	—	35
	32	16	18.9	23.8	18 000	25V3216	—	25
	32	24	26.4	36.7	18 000	RS253224	—	43
	32	32	37.8	58.4	18 000	RP253232F-1	Double split	51
	32	32	39.6	62.0	18 000	RV253232	—	49
	33	20	24.1	29.8	17 000	RV253320	—	35
33	23.8	30.2	40.0	17 000	25R3324B-1	Width tolerance special ¹⁾	48	
33	30	38.6	54.8	17 000	RF253330	Polyamide	41	
35	25	32.5	38.0	17 000	25R3525	—	65	

Needle roller and cage assemblies

F_w (25) ~ 29 mm

F_w 30 ~ (32) mm

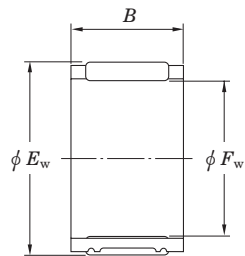

RS, R, RP

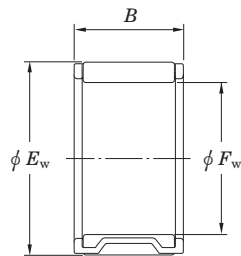

RV, V, VS

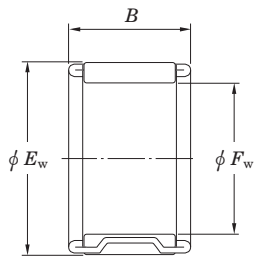

VP, VPS

ϕE_w : Roller set outside diameter
 ϕF_w : Roller set bore diameter

Boundary dimensions (mm)	Basic load ratings (kN)		Limiting speeds (min ⁻¹) Oil lub.	Bearing No.	Special series (Cage)	(Refer.) Mass (g)	
	F_w	E_w					B
25	35	30	39.6	49.0	17 000	25V3530A —	69
	37	24	34.1	36.2	16 000	25V3724 —	69
	37	25	38.3	42.2	16 000	25V3725A —	77
	37	33	47.5	55.7	16 000	RV253733 —	96
26	30	20	16.9	30.6	18 000	RS263020 —	20
	30	21.9	16.9	30.4	18 000	RS263022A —	22
	31	16	15.7	23.8	18 000	RS263116 —	20
	31	19	18.5	29.5	18 000	RS263119 —	24
	33	34	30.4	44.0	17 000	RPU263334F Double split	42
	34	17	23.9	30.0	17 000	RV263417 —	32
27	32	27	26.2	46.6	17 000	RFN27/27 Polyamide, Width tolerance special ¹⁾	20
	33	28.6	30.0	49.2	17 000	VPSU27/29AF Double split	33
28	32	26	17.1	31.5	17 000	28R3226 —	27
	32	29	17.1	31.5	17 000	28R3229 —	32
	33	17	17.9	29.0	16 000	28R3317 —	22
	33	23	22.8	39.6	16 000	R28/23A —	31
	33	27	25.0	44.5	16 000	R28/27 —	36
	36	20	23.2	29.3	16 000	28R3620 —	45
	38	24	31.2	37.1	15 000	RS283824 —	70
	40	28	49.1	59.5	15 000	RV284028 —	90
	41	25	40.2	43.6	14 000	RV284125 —	86
	42	50.5	88.9	116.5	14 000	RF284251A Polyamide	182
29	34	22	17.3	27.6	16 000	R29/22A —	30
	34	24.4	19.7	32.8	16 000	RFU293424A With double split polyamide	17
	34	27	25.7	46.7	16 000	29R3427A-1 —	37
	43	43	73.7	92.2	14 000	RV294343 —	177

Boundary dimensions (mm)	Basic load ratings (kN)		Limiting speeds (min ⁻¹) Oil lub.	Bearing No.	Special series (Cage)	(Refer.) Mass (g)	
	F_w	E_w					B
30	34	14	7.7	11.4	16 000	30R3414A —	16
	34	14	7.7	11.5	16 000	RFN303414 Polyamide	6.1
	34	29	18.1	34.8	16 000	30R3429 —	34
	34	29	20.4	40.8	16 000	RSU303429 Double split	33
	35	17	17.7	29.2	15 000	R30/17-1 —	24
	35	21.1	22.2	39.0	15 000	RS303521A —	30
	35	24	24.9	45.1	15 000	RS303524 —	34
	37	16	21.8	30.3	15 000	RV303716 —	29
	37	20	25.2	36.6	15 000	RS30/20A —	41
	37	26	34.7	55.3	15 000	RV303726 —	47
	38	22.1	27.7	37.5	15 000	RP303822A Welded	45
	38	28.3	33.5	47.8	15 000	RPU303828AF Double split	47
	39	27	34.2	45.6	14 000	RP303927 —	51
	39	30	38.3	52.8	14 000	30VP3930A Width tolerance special ¹⁾	58
	39	32	42.6	60.5	14 000	RP303932 Welded, Width tolerance special ¹⁾	63
	40	15.5	26.7	31.1	14 000	RV304016A-4 —	46
40	20	32.0	39.1	14 000	30V4020 —	55	
42	15	27.0	28.0	14 000	RF304215 Polyamide	36	
42	25	44.0	52.3	14 000	RV304225 —	84	
42	32	52.7	66.0	14 000	30V4232 Width tolerance special ¹⁾	108	
45	30	54.4	60.2	13 000	30V4530 —	135	
31	36	20.3	19.9	34.2	15 000	RFU313620A-1 With double split polyamide	17
32	36	15	10.8	18.3	15 000	32R3615A —	19
	37	17	19.0	32.6	14 000	R32/17-1 —	26
	37	20	22.3	39.9	14 000	R32/20 —	30
	37	23.8	22.6	40.5	14 000	RF323724A-1 With single split polyamide	20
	37	26	26.2	49.0	14 000	RF323726 Polyamide, Width tolerance special ¹⁾	24
	37	29.5	31.1	61.2	14 000	VP32/30A —	32

[Note] 1) For further information, consult with JTEKT.

[Remark] Limiting speed of grease lubrication should be kept to under 60 % of that for oil lubrication.

Needle roller and cage assemblies

F_w (32) ~ (35) mm

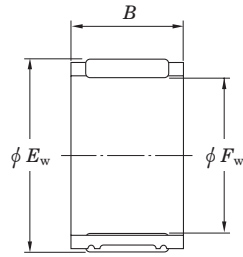

RS, R, RP

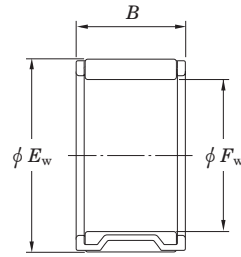

RV, V, VS

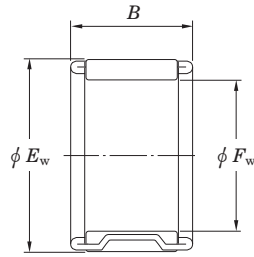

VP, VPS

F_w (35) ~ 37 mm

ϕE_w : Roller set outside diameter

ϕF_w : Roller set bore diameter

Boundary dimensions (mm)			Basic load ratings (kN)		Limiting speeds (min ⁻¹)	Bearing No.	Special series (Cage)	(Refer.) Mass (g)
F_w	E_w	B	C_r	C_{0r}	Oil lub.			
32	38	20	24.9	40.6	14 000	32VP3820A	Welded	27
	38	26	27.3	45.6	14 000	RP323826	Width tolerance special ¹⁾	34
	38	27	29.6	50.7	14 000	32VP3827	Width tolerance special ¹⁾	38
	39	16	21.2	29.8	14 000	RS323916	—	35
	42	16	27.5	32.9	14 000	RV324216	—	49
	42	20.5	33.5	42.2	14 000	RV324221-1	—	64
	45	28	47.9	56.5	13 000	32V4528	—	112
	46	18	37.0	38.8	13 000	RF324618	Polyamide	57
	46	18	30.3	29.8	13 000	RV324618-1	—	71
33	37	22	18.5	37.2	14 000	RSU333722F	Double split	27
34	39	20.3	19.6	34.4	14 000	RFU343920A	With double split polyamide	18
	42	38	49.2	81.9	13 000	34R4238	Width tolerance special ¹⁾	98
	44	40	64.1	99.1	13 000	34VP4440-1	—	101
35	39	25	22.0	47.4	14 000	RF353925	With single split polyamide	24
	40	13	14.2	23.0	13 000	RS354013	—	22
	40	17	18.4	32.0	13 000	RS354017	—	29
	40	22	23.6	44.4	13 000	RS354022	—	37
	40	24	25.9	49.9	13 000	RS354024	—	39
	40	24.8	23.7	44.4	13 000	RSU354025AF	Double split	39
	40	25	27.0	52.7	13 000	RS354025-1	—	41
	40	26	28.7	56.9	13 000	RS354026	—	41
	40	28	28.7	56.9	13 000	RF354028	Polyamide	27
	40	29	30.6	61.7	13 000	RP354029-1	Width tolerance special ¹⁾	33
	40	30	30.6	61.7	13 000	VP35/30	—	34
	40	31	30.6	61.6	13 000	RP354031	Welded, Width tolerance special ¹⁾	37
	40	33	31.1	63.2	13 000	RP354033-1	—	39
	40	35	31.8	64.9	13 000	RF354035	Polyamide	32

Boundary dimensions (mm)			Basic load ratings (kN)		Limiting speeds (min ⁻¹)	Bearing No.	Special series (Cage)	(Refer.) Mass (g)
F_w	E_w	B	C_r	C_{0r}	Oil lub.			
35	41	35	40.4	78.0	13 000	35VP4135A	—	51
	41	40	42.4	82.6	13 000	35VP4140A	—	59
	42	20	27.2	42.0	13 000	VS35/20	—	42
	42	30	39.9	68.8	13 000	VS35/30	Width tolerance special ¹⁾	59
	48	17.5	37.8	42.7	12 000	RV354818A-4	—	81
	49	25	53.4	63.4	12 000	RV354925-1	—	120
	49	25	53.4	63.4	12 000	RV354925-1	—	120
36	40	10	9.6	16.5	13 000	36R4010	—	14
	41	20	21.7	40.3	13 000	RS364120	—	34
	41	25	29.9	60.6	13 000	36RFN4125A	Polyamide	27
	41	30.5	33.1	69.2	13 000	R36/31	—	51
	42	17	20.5	32.8	13 000	RS364217-K	—	35
	42	19	23.2	38.6	13 000	RS364219-K	—	39
	42	21	25.9	44.4	13 000	RS364221-K	—	44
	42	25	33.1	60.9	13 000	RF364225-1	Polyamide	34
	48	25	54.0	71.7	12 000	RF364825-1	Polyamide	80
	52	30	73.9	89.9	11 000	RF365230	Polyamide	139
37	42	11.6	11.3	17.5	13 000	RS374212A	—	23
	42	12.8	14.0	23.2	13 000	VP37/13A	Width tolerance special ¹⁾	14
	42	17.3	21.3	39.7	13 000	VP37/17	Width tolerance special ¹⁾	21
	42	22	24.0	46.3	13 000	37R4222	—	38
	42	23	23.8	45.5	13 000	RF374223-1	With single split polyamide	22
	42	27	30.8	63.6	13 000	RS374227	—	46
	42	27	30.0	61.5	13 000	RSU374227	Double split	45
	42	29	31.9	66.5	13 000	VP37/29	—	35
	42	31	33.9	72.1	13 000	RS374231	Welded	52
	42	32	31.2	64.3	13 000	VP37/32	—	37
	43	32	39.1	75.8	13 000	37R4332	—	66
	43	36.8	40.0	77.9	13 000	RPU374337F	Double split	60

[Note] 1) For further information, consult with JTEKT.

[Remark] Limiting speed of grease lubrication should be kept to under 60 % of that for oil lubrication.

Needle roller and cage assemblies

F_w 38 ~ 41 mm

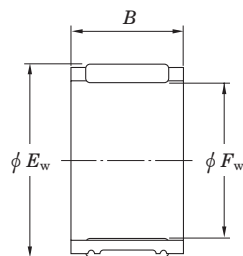

RS, R, RP

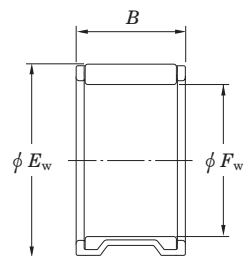

RV, V, VS

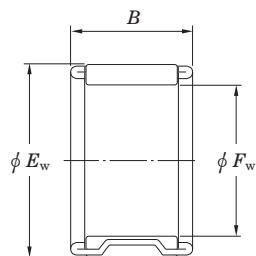

VP, VPS

F_w 42 ~ (45) mm

ϕE_w : Roller set outside diameter

ϕF_w : Roller set bore diameter

Boundary dimensions (mm)	Basic load ratings (kN)		Limiting speeds (min ⁻¹)		Bearing No.	Special series (Cage)	(Refer.) Mass (g)	
	F_w	E_w	B	C_r				C_{0r}
38	42	10	8.9	15.2	13 000	RF384210 Polyamide	6.6	
	44	23.4	25.1	43.1	12 000	RF384423A Polyamide	26	
	44	24.5	27.5	48.4	12 000	RSU384425AF Double split	51	
	44	26	28.7	51.1	12 000	RF384426 Polyamide	29	
	44	33	37.9	73.4	12 000	RP384433 —	64	
	44	36.2	39.9	78.1	12 000	RP384436A —	57	
	44	39.8	43.7	88.1	12 000	RP384440A —	65	
	52	39	74.8	99.2	11 000	RP385239 —	155	
39	46	32.8	42.4	76.9	12 000	39R4633 —	82	
	55	20.5	55.0	62.6	11 000	RF39521A Polyamide	98	
	59	23	63.8	66.3	10 000	RV395923-1 —	196	
40	45	13	17.1	30.8	12 000	RV404513 —	22	
	45	17	19.9	37.4	12 000	R40/17-1 —	32	
	45	21.2	23.6	46.6	12 000	RS404521A —	40	
	45	27	29.9	63.0	12 000	RS404527 —	49	
	45	30	30.5	64.4	12 000	R40/30 —	55	
	45	32	14.3	23.3	12 000	R40/32A —	53	
	46	14.5	21.2	35.5	12 000	RP404615A Welded	31	
	46	29	36.4	70.6	12 000	RS404629 —	65	
	47	20	27.6	44.8	11 000	RS40/20 —	54	
	47	28.5	38.0	67.6	11 000	RS40/29A —	77	
	48	34	50.4	88.3	11 000	40V4834 —	87	
	55	27.5	68.0	85.6	11 000	RF405528A-1 Polyamide	124	
	56	20	50.8	56.7	10 000	RV405620-4 —	122	
	57	31.5	83.4	103	10 000	RF405732A Polyamide	168	
	60	31.5	94.1	110	10 000	RF406032A Polyamide	214	
	41	46	24	11.0	16.8	11 000	41R4624A —	44

[Note] 1) For further information, consult with JTEKT.

[Remark] Limiting speed of grease lubrication should be kept to under 60 % of that for oil lubrication.

Boundary dimensions (mm)	Basic load ratings (kN)		Limiting speeds (min ⁻¹)		Bearing No.	Special series (Cage)	(Refer.) Mass (g)
	F_w	E_w	B	C_r			
42	47	10	13.9	23.8	11 000	RS424710-1 Welded	21
	47	25	29.5	63.1	11 000	RS424725 —	52
	47	27	32.3	70.8	11 000	RS424727 —	51
	47	30	31.9	69.8	11 000	RSU424730 Double split	58
	47	30	36.3	82.4	11 000	VP42/30 —	44
	49	22	29.3	49.0	11 000	RF424922 Polyamide	35
43	48	18	21.9	43.2	11 000	RS434818 —	36
	48	18.5	22.1	43.7	11 000	RS434819A-2 —	38
	48	21.2	25.0	51.5	11 000	RS434821A —	46
	48	23.3	29.4	63.2	11 000	RS434823A —	46
	48	24.4	28.2	59.9	11 000	RS434824A —	49
	48	30	34.1	76.5	11 000	RS434830 Welded	58
	49	31	40.1	82.5	11 000	43VP4931E —	55
52	39.9	65.2	116	11 000	43VP5240 —	114	
44	50	27.5	36.0	72.2	11 000	44RFN5028 Polyamide	39
	50	39	46.4	100	11 000	RP445039 —	71
45	50	13	16.0	29.4	11 000	R45/13 —	28
	50	17	22.7	46.1	11 000	RS455017 —	35
	50	19	24.1	49.7	11 000	R45/19 —	39
	50	20.2	24.1	49.6	11 000	RS455020A —	46
	50	24	29.3	63.9	11 000	RS455024 —	50
	50	26	31.8	70.9	11 000	R45/26 —	54
	50	33	37.3	87.0	11 000	RS455033-1 —	69
	51	28.6	34.1	67.7	10 000	45RFN5129 Polyamide	40
	51	28.9	37.5	76.9	10 000	RP455129A Welded	65
	51	28.9	37.5	76.9	10 000	RPU455129AF Double split	67
	52	22	35.4	63.9	10 000	RS455222 —	66

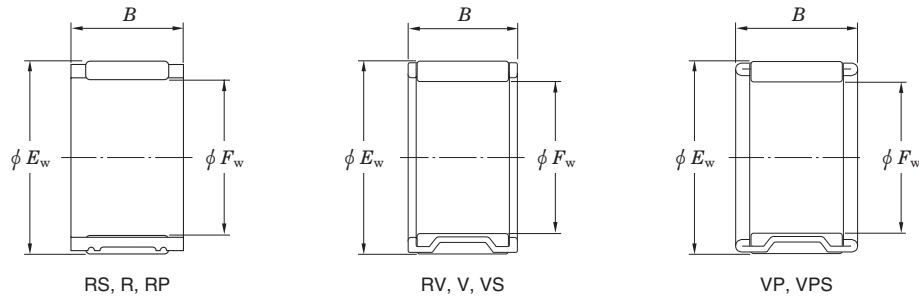
F_W (45) ~ (50) mm

Boundary dimensions (mm)			Basic load ratings (kN)		Limiting speeds (min ⁻¹) Oil lub.	Bearing No.	Special series (Cage)	(Refer.) Mass (g)
F_w	E_w	B	C_r	C_{0r}				
45	53	25	41.4	71.1	10 000	RV455325P	—	73
	53	26	41.4	71.1	10 000	45V5326P	—	77
	53	28	42.3	73.2	10 000	45VP5328	Width tolerance special ¹⁾	66
	64	23	64.0	70.4	9 200	RV456423-7	—	191
46	52	20	25.9	48.2	10 000	46VP5220	—	34
	52	37	45.8	100	10 000	46VP5237B	—	67
47	52	30	36.4	85.4	10 000	R47/30H	—	62
	52	30	35.1	81.7	10 000	RSU475230F-1	Double split	62
	53	28.8	35.3	72.3	10 000	RP475329A	—	55
	53	30	42.6	92.1	10 000	RP475330-1	Welded	74
	53	36	47.0	104	10 000	RP475336	—	68
48	53	13	16.1	30.1	9 900	RS485313	—	30
	53	28	34.1	79.2	9 900	48R5328	—	60
	54	20	29.3	57.3	9 800	48R5420-1	—	54
	54	27	38.1	80.4	9 800	48R5427	—	72
	54	28	37.8	79.3	9 800	RS485428	Welded	72
	54	29	39.5	84.3	9 800	48R5429	—	78
	54	30.2	43.8	96.2	9 800	RP485430A-1	Welded	72
	54	39	47.9	108	9 800	48R5439	—	106
	55	21	32.4	58.1	9 700	RP485521	Welded	60
	49	56	44.6	61.2	133	9 500	RP495645A	Welded
56		44.6	61.2	133	9 500	RS495645A	—	146
50	55	17.5	22.3	46.5	9 500	RS505518A	Welded	39
	55	20	25.1	54.3	9 500	RS505520-1	—	47
	55	27	11.5	18.9	9 500	R50/27A	—	56
	56	13	16.7	28.2	9 400	RF505613	Polyamide	18

[Note] 1) For further information, consult with JTEKT.

[Remark] Limiting speed of grease lubrication should be kept to under 60 % of that for oil lubrication.

 F_W (50) ~ (58) mm ϕE_w : Roller set outside diameter ϕF_w : Roller set bore diameter

Boundary dimensions (mm)			Basic load ratings (kN)		Limiting speeds (min ⁻¹) Oil lub.	Bearing No.	Special series (Cage)	(Refer.) Mass (g)
F_w	E_w	B	C_r	C_{0r}				
50	56	28	39.5	85.5	9 400	RP505628	Welded	69
	56	30	41.0	89.6	9 400	RF505630	Polyamide	50
	57	33.5	47.8	97.1	9 300	RP505734A	—	79
	57	38.9	58.3	126	9 300	RS505739A	—	133
	57	40.8	60.9	133	9 300	RS505741A	—	127
	58	25	38.5	66.9	9 300	RF505825	Polyamide	53
	70	36	114	147	8 300	RF507036	Polyamide	277
	51	56	28	34.8	83.0	9 300	VP51/28	—
52	72	32	108	138	8 100	RF527232	Polyamide	259
53	58	25	32.2	76.0	9 000	RF535825	Polyamide	35
54	60	31.1	45.3	104	8 800	RP546031A	Welded	83
	60	36	45.5	105	8 800	RP546036	Welded, Width tolerance special ¹⁾	82
	61	34.7	60.2	135	8 700	RPU546135AF	Double split	116
	61	41.3	63.3	143	8 700	RS546141A	—	145
55	59	13	10.8	21.9	8 800	55RFN5913A	Polyamide	11
	60	20	26.7	60.6	8 700	R55/20	—	52
	60	28	35.8	88.4	8 700	RS556028	—	69
56	60	20	24.0	62.4	8 600	RF566020	Polyamide	23
	61	11	13.6	25.6	8 500	RF566111	Polyamide	14
	61	30	39.7	102	8 500	RS566130	Welded	75
	61	33.5	42.5	111	8 500	R56/34	—	85
	58	65	26	42.1	87.1	8 100	58R6526	Width tolerance special ¹⁾
	65	36.6	55.7	125	8 100	58RFN6537A	Polyamide	80
	65	36.6	56.4	127	8 100	RS586537A-2	—	145

F_w (58) ~ 78 mm

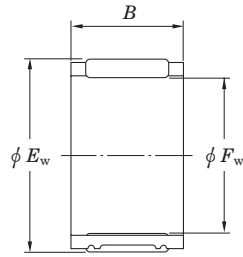

RS, R, RP

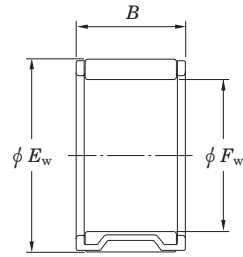

RV, V, VS

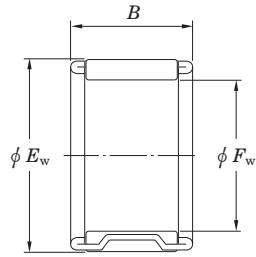

VP, VPS

ϕE_w : Roller set outside diameter

ϕF_w : Roller set bore diameter

Boundary dimensions (mm)	Basic load ratings (kN)		Limiting speeds (min ⁻¹)		Oil lub.	Bearing No.	Special series (Cage)	(Refer.) Mass (g)
	F_w	E_w	B	C_r				
58	65	37.5	57.7	131	8 100	RP586538A	Welded, Width tolerance special ¹⁾	108
	80	72	233	359	7 200	RV588072	—	889
60	65	30	40.0	105	8 000	R60/30	—	81
	66	19	31.5	67.8	7 900	RS606619	—	63
	67	23	40.1	82.8	7 900	60V6723	—	77
	82	30	118	152	7 000	RF608230	Polyamide	316
63	68	30	40.9	110	7 600	R63/30	—	83
64	70	24.5	39.4	92.4	7 500	64R7025A	—	86
	70	35	55.7	144	7 500	64R7035	—	122
65	70	20	12.1	22.3	7 400	R65/20A	—	57
	70	24	12.5	22.9	7 400	R65/24A	—	67
70	76	20	34.7	80.8	6 800	70R7620	—	77
	76	32	55.1	147	6 800	RP707632	Welded	116
	78	30	59.4	132	6 800	70R7830	—	154
71	79	30.15	61.3	138	6 700	71V7930B	—	135
	79	39.5	75.3	179	6 700	RS717940AZ	—	203
72	79	21	39.6	86.6	6 600	72V7921	—	84
73	79	20	36.3	86.8	6 600	R73/20	—	84
78	85	33.75	62.3	159	6 100	78R8534A	—	168

[Note] 1) For further information, consult with JTEKT.

[Remark] Limiting speed of grease lubrication should be kept to under 60 % of that for oil lubrication.

Drawn cup needle roller bearings

F_w 4 ~ (12) mm

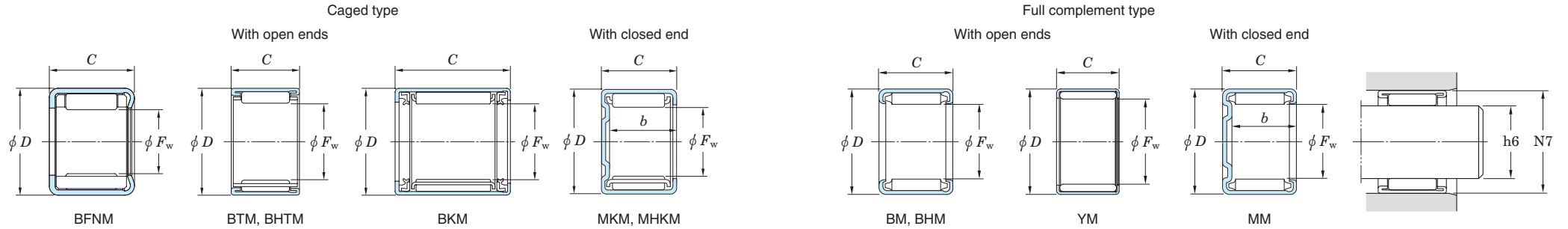

Boundary dimensions (mm)				Basic load ratings (kN)		Limiting speeds (min ⁻¹)	Bearing No. ²⁾				Recommended dimensions (mm)				(Refer.) Mass (g)	
F_w	D	C	$b_{min.}$	C_r	C_{0r}		Oil lub.	Caged type		Full complement type		Shaft dia. (h6)		Housing bore dia. (N7)		With open ends
							With open ends	With closed end	With open ends	With closed end	min.	max.	min.	max.		
4	8	8	—	1.60	1.25	47 000	4BFNM88	—	—	—	3.992	4.000	7.981	7.996	1.3	—
5	9	9	—	2.40	2.15	44 000	5BFNM99	—	—	—	4.992	5.000	8.981	8.996	1.8	—
6	10	9	6	2.40	2.40	42 000	6BTM109	—	—	—	5.992	6.000	9.981	9.996	2.5	—
7	11	9	—	2.55	2.70	39 000	7BTM119	—	—	—	6.991	7.000	10.977	10.995	2.9	—
8	12	10	8.4	3.25	3.85	37 000	8BTM1210	8MKM1210	—	—	7.991	8.000	11.977	11.995	3.6	4.1
	12	10	7.8	4.95	7.50	13 000	—	—	BM081210	8MM1210	7.991	8.000	11.977	11.995	3.7	4.2
	12	10	—	5.25	8.60	13 000	—	—	YM081210	—	7.991	8.000	11.977	11.995	4.0	—
	15	10	8.4	4.00	3.30	34 000	BHTM810	MHKM810	—	—	7.991	8.000	14.977	14.995	6.5	7.3
	15	15	—	7.45	6.50	34 000	BHTM815	—	—	—	7.991	8.000	14.977	14.995	9.4	—
15	20	17.3	9.25	9.70	34 000	BHTM820	MHKM820	—	—	—	7.991	8.000	14.977	14.995	13	14
9	13	10	7.8	4.90	8.05	12 000	—	—	9BM1310	9MM1310	8.991	9.000	12.977	12.995	4.0	4.6
	13	10	8.4	3.35	4.10	35 000	9BTM1310A	9MKM1310	—	—	8.991	9.000	12.977	12.995	3.8	4.3
	13	12	10.4	4.20	5.50	35 000	9BTM1312	9MKM1312	—	—	8.991	9.000	12.977	12.995	4.6	5.2
	16	12	10.4	5.35	5.05	32 000	BHTM912-1	MHKM912	—	—	8.991	9.000	15.977	15.995	8.8	9.9
	16	16	13.3	7.55	7.90	32 000	BHTM916	MHKM916	—	—	8.991	9.000	15.977	15.995	12	13
10	14	10	7.8	5.70	9.35	11 000	—	—	10BM1410	10MM1410	9.991	10.000	13.977	13.995	4.2	4.8
	14	10	8.4	3.55	4.55	33 000	10BTM1410	10MKM1410	—	—	9.991	10.000	13.977	13.995	4.2	4.8
	14	12	10.4	4.40	6.00	33 000	10BTM1412	10MKM1412	—	—	9.991	10.000	13.977	13.995	5.0	5.7
	14	15	11.8	5.65	8.25	33 000	BTM101415	—	—	—	9.991	10.000	13.977	13.995	6.4	—
	17	10	8.4	4.65	4.25	30 000	BHTM1010	MHKM1010	—	—	9.991	10.000	16.977	16.995	7.8	8.9
	17	12	10.4	6.00	5.90	30 000	BHTM1012-1	MHKM1012	—	—	9.991	10.000	16.977	16.995	9.4	11
	17	15	—	7.85	8.45	30 000	BHTM1015	—	—	—	9.991	10.000	16.977	16.995	12	—
17	20	17.3	10.7	12.5	30 000	BHTM1020	MHKM1020	—	—	—	9.991	10.000	16.977	16.995	16	18
12	16	10	8.4	4.00	5.60	29 000	12BTM1610	12MKM1610	—	—	11.989	12.000	15.977	15.995	5.0	5.6

[Notes] 1) The limiting speeds shown above are applicable when oil seal is used and the bearing is lubricated with grease.
 2) FN in bearing number indicates a bearing comprising polyamide molded cage.
 3) The recommended dimensional tolerances of shaft shown above are applicable except h6.
 4) The recommended dimensional tolerances of housing bore shown above are applicable except N7.

[Remark] Limiting speed of grease lubrication should be kept to under 60 % of that for oil lubrication.

Drawn cup needle roller bearings

F_w (12) ~ 14.50 mm

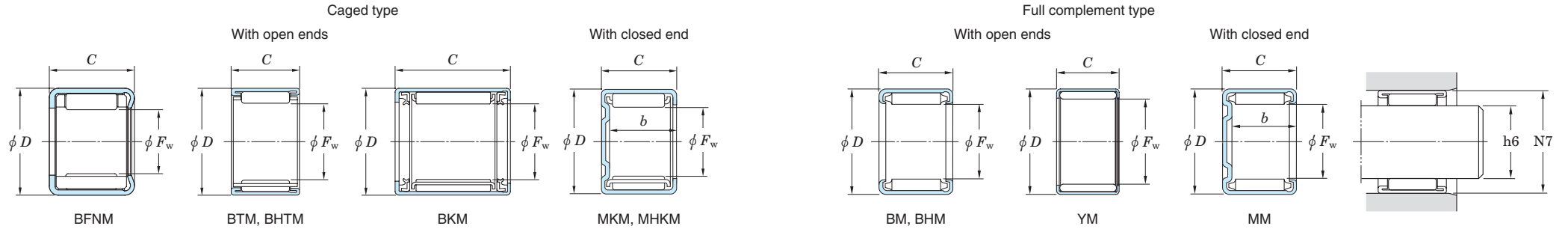

Boundary dimensions (mm)				Basic load ratings (kN)		Limiting speeds (min ⁻¹)	Bearing No. ²⁾				Recommended dimensions (mm)				(Refer.) Mass (g)	
F_w	D	C	$b_{min.}$	C_r	C_{0r}	Oil lub.	Caged type		Full complement type		Shaft dia. (h6)		Housing bore dia. (N7)		With open ends	With closed end
							With open ends	With closed end	With open ends	With closed end	min.	max.	min.	max.		
12	18	10	8.4	4.60	4.80	27 000	12BTM1810	12MKM1810	—	—	11.989	12.000	17.977	17.995	7.2	8.2
	18	12	9.6	8.40	12.6	9 400	—	—	12BM1812	12MM1812	11.989	12.000	17.977	17.995	9.7	11
	18	12	9.3	5.95	6.70	27 000	12BTM1812	12MKM1812	—	—	11.989	12.000	17.977	17.995	7.6	8.5
	18	15	—	6.10	7.32	27 000	12BTM1815A	—	—	—	11.989	12.000	17.991 ⁴⁾	18.012 ⁴⁾	12	—
	18	16	—	5.65	6.25	16 000 ¹⁾	12BKM1816UU	—	—	—	11.989	12.000	17.977	17.995	11	—
	19	12	9.3	6.70	6.95	26 000	BHTM1212-1	MHKM1212	—	—	11.989	12.000	18.972	18.993	10	12
	19	15	—	8.85	9.95	26 000	BHTM1215-1	MKM121915	—	—	11.989	12.000	18.972	18.993	13	—
	19	20	17.3	12.1	14.9	26 000	BHTM1220	MHKM1220	—	—	11.989	12.000	18.972	18.993	17	19
	19	25	—	15.0	19.6	26 000	BHTM1225	—	—	—	11.989	12.000	18.972	18.993	21	—
13	17	15	—	5.10	7.85	27 000	BKM131715J	—	—	—	12.989	12.000	16.977	16.995	7.1	—
	19	12	—	8.55	13.4	9 100	—	—	13BM1912	—	12.989	13.000	18.972	18.993	10	—
	19	12	9.3	5.85	6.70	26 000	13BTM1912	13MKM1912	—	—	12.989	13.000	18.972	18.993	9.5	11
	19	14	—	7.65	9.60	26 000	BKM131914J	—	—	—	12.989	13.000	18.972	18.993	11	—
	20	12	—	7.50	8.40	25 000	13BTM2012J	—	—	—	12.989	13.000	19.972	19.993	11	—
	21	14	—	9.75	10.5	25 000	BKM132114BJ	—	—	—	12.989	13.000	20.972	20.993	15	—
13.50	19	12	—	6.25	7.95	25 000	BTM141912A	—	—	—	13.447 ³⁾	13.460 ³⁾	19.000 ⁴⁾	19.021 ⁴⁾	9.5	—
14	19	16	13.7	11.7	23.3	8 800	—	—	14BM1916	14MM1916	13.989	14.000	18.972	18.993	12	14
	19	16	13.3	7.85	11.7	25 000	14BTM1916B	14MKM1916	—	—	13.983 ³⁾	13.994 ³⁾	18.972	18.993	11	12
	20	12	9.6	9.15	14.6	8 600	—	—	14BM2012	14MM2012	13.989	14.000	19.972	19.993	11	12
	20	12	9.3	6.10	7.20	25 000	14BTM2012	14MKM2012	—	—	13.989	14.000	19.972	19.993	9.8	11
	20	16	13.7	12.7	22.4	8 600	—	—	14BM2016	14MM2016	13.989	14.000	19.972	19.993	15	17
	20	16	13.3	8.75	11.4	25 000	14BTM2016	14MKM2016	—	—	13.989	14.000	19.972	19.993	13	15
	20	25	—	12.2	15.5	14 000 ¹⁾	14BKM2025JUJ	—	—	—	13.989	14.000	19.972	19.993	20	—
	22	16	13.3	11.1	12.6	23 000	BHTM1416	MHKM1416	—	—	13.989	14.000	21.972	21.993	19	21
22	20	17.3	14.4	17.5	23 000	BHTM1420	MHKM1420	—	—	13.989	14.000	21.972	21.993	23	26	
14.50	19.50	13.50	—	7.55	10.9	25 000	BTM152014A	—	—	—	14.489	14.500	19.472	19.493	9.5	—

[Notes] 1) The limiting speeds shown above are applicable when oil seal is used and the bearing is lubricated with grease.
 2) FN in bearing number indicates a bearing comprising polyamide molded cage.
 3) The recommended dimensional tolerances of shaft shown above are applicable except h6.
 4) The recommended dimensional tolerances of housing bore shown above are applicable except N7.

[Remark] Limiting speed of grease lubrication should be kept to under 60 % of that for oil lubrication.

Drawn cup needle roller bearings

F_w 15 ~ (17) mm

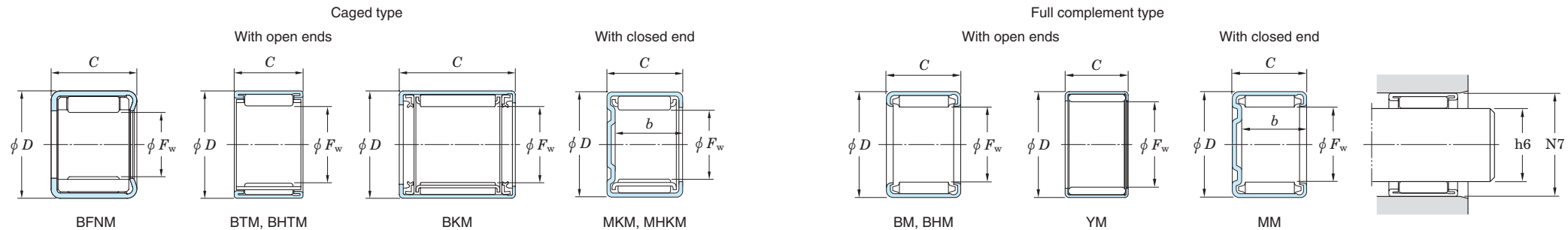

F_w	Boundary dimensions (mm)			Basic load ratings (kN)		Limiting speeds (min ⁻¹) Oil lub.	Bearing No. ²⁾				Recommended dimensions (mm)				(Refer.) Mass (g)	
	D	C	b min.	C_r	C_{0r}		Caged type		Full complement type		Shaft dia. (h6)		Housing bore dia. (N7)		With open ends	With closed end
							With open ends	With closed end	With open ends	With closed end	min.	max.	min.	max.		
15	20	16	—	8.15	12.6	24 000	15BTM2016C-2	—	—	—	14.989	15.000	19.991 ⁴⁾	20.012 ⁴⁾	12	—
	21	10	—	7.70	11.8	8 100	—	—	15BM2110	—	14.989	15.000	20.972	20.993	9.4	—
	21	10	—	5.25	6.25	23 000	15BTM2110JA	—	—	—	14.989	15.000	20.991 ⁴⁾	21.012 ⁴⁾	9.5	—
	21	12	9.6	9.70	15.9	8 100	—	—	15BM2112	15MM2112	14.989	15.000	20.972	20.993	12	13
	21	12	9.3	7.00	8.80	23 000	15BTM2112-1	15MKM2112	—	—	14.989	15.000	20.972	20.993	11	12
	21	16	13.7	13.4	24.2	8 100	—	—	15BM2116	15MM2116	14.989	15.000	20.972	20.993	16	18
	21	16	13.3	9.80	13.6	23 000	15BTM2116	15MKM2116	—	—	14.989	15.000	20.972	20.993	14	16
	21	22	—	13.0	19.5	23 000	15BTM2122	—	—	—	14.989	15.000	20.991 ⁴⁾	21.012 ⁴⁾	20	—
	22	10	8.4	6.15	6.45	23 000	BHTM1510	MHKM1510	—	—	14.989	15.000	21.972	21.993	9.9	11
	22	12	9.3	6.90	7.95	23 000	BHTM1512A	MHKM1512	—	—	14.989	15.000	21.991 ⁴⁾	22.012 ⁴⁾	12	14
	22	15	—	10.9	13.3	23 000	BHTM1515-1	—	—	—	14.989	15.000	21.972	21.993	10	—
	22	20	17.3	14.2	18.8	23 000	BHTM1520	MHKM1520	—	—	14.989	15.000	21.972	21.993	20	23
	22	25	—	17.7	25.0	23 000	BHTM1525	—	—	—	14.989	15.000	21.972	21.993	26	—
	16	22	12	9.6	10.2	17.1	7 700	—	—	16BM2212	16MM2212	15.989	16.000	21.972	21.993	12
22		12	9.3	7.60	9.80	22 000	16BTM2212A	16MKM2212	—	—	15.989	16.000	21.991 ⁴⁾	22.012 ⁴⁾	11	12
22		16	13.7	14.1	25.9	7 700	—	—	16BM2216	16MM2216	15.989	16.000	21.972	21.993	17	19
22		16	13.3	10.7	15.1	22 000	16BTM2216	16MKM2216	—	—	15.989	16.000	21.972	21.993	15	17
22		22	—	16.2	22.9	22 000	16BTM2222B	—	—	—	15.989	16.000	21.991 ⁴⁾	22.012 ⁴⁾	20	—
24		12	—	8.00	8.45	21 000	BHTM1612	—	—	—	15.989	16.000	23.972	23.993	15	—
24		16	13.3	12.2	14.9	21 000	BHTM1616A	MHKM1616	—	—	15.989	16.000	23.991 ⁴⁾	24.012 ⁴⁾	20	23
24.15		14	12.6	8.45	9.05	12 000 ¹⁾	—	MKM162414U	—	—	15.989	16.000	24.122	24.143	—	19
17	21.50	15	10.6	6.15	9.60	22 000	17BTM2215	—	—	—	16.989	17.000	21.472	21.493	10	—
	22	10	—	5.05	6.90	21 000	BTM1710	—	—	—	16.989	17.000	21.972	21.993	8.2	—
	22	13	—	10.6	21.6	7 500	—	—	BM1713-1	—	16.989	17.000	21.972	21.993	12	—
	23	12	9.6	10.3	17.9	7 300	—	—	17BM2312	17MM2312	16.989	17.000	22.972	22.993	13	15
	23	12	—	7.65	10.2	21 000	BTM172312	—	—	—	16.989	17.000	22.972	22.993	12	—
	23	20	—	18.0	36.7	7 300	—	—	17BM2320	—	16.989	17.000	22.972	22.993	23	—

[Notes] 1) The limiting speeds shown above are applicable when oil seal is used and the bearing is lubricated with grease.

[Remark] Limiting speed of grease lubrication should be kept to under 60 % of that for oil lubrication.

2) FN in bearing number indicates a bearing comprising polyamide molded cage.

3) The recommended dimensional tolerances of shaft shown above are applicable except h6.

4) The recommended dimensional tolerances of housing bore shown above are applicable except N7.

F_w (17) ~ 19 mm

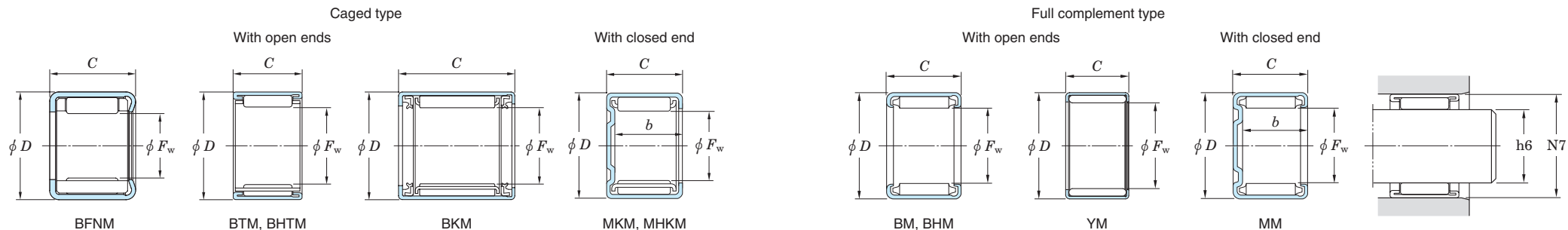

F_w	Boundary dimensions (mm)			Basic load ratings (kN)		Limiting speeds (min ⁻¹) Oil lub.	Bearing No. ²⁾		Recommended dimensions (mm)				(Refer.) Mass (g)			
	D	C	b min.	C_r	C_{0r}		With open ends	With closed end	With open ends	With closed end	Shaft dia. (h6) min.	Shaft dia. (h6) max.	Housing bore dia. (N7) min.	Housing bore dia. (N7) max.	With open ends	With closed end
17	24	12	—	12.8	21.0	7 200	—	—	YM172412-1	—	16.983 ³⁾	16.994 ³⁾	23.985 ⁴⁾	24.006 ⁴⁾	17	—
	24	15	—	11.2	14.8	20 000	BHTM1715-1	—	—	—	16.989	17.000	23.972	23.993	17	—
	24	17	—	16.0	27.9	7 200	—	—	BM172417-1	—	16.989	17.000	23.991 ⁴⁾	24.012 ⁴⁾	23	—
	24	20	—	12.9	17.6	11 000 ¹⁾	BHKM1720JBU	—	—	—	16.989	17.000	23.972	23.993	22	—
	24	20	—	19.0	21.9	7 200	—	—	BHM1720A	—	16.983 ³⁾	16.994 ³⁾	23.985 ⁴⁾	24.006 ⁴⁾	27	—
	24	20	17.3	15.1	21.6	20 000	BHTM1720-1	MHKM1720	—	—	16.989	17.000	23.972	23.993	24	27
	24	25	—	23.8	46.6	7 200	—	—	BHM1725	—	16.989	17.000	23.991 ⁴⁾	24.012 ⁴⁾	35	—
	24	25	—	19.0	29.0	20 000	BTM172425	—	—	—	16.983 ³⁾	16.994 ³⁾	23.972	23.993	22	—
	24	26	—	16.0	23.3	11 000 ¹⁾	BHKM1726JUJ	—	—	—	16.999	17.000	23.972	23.993	29	—
	24	30	—	20.1	31.3	11 000 ¹⁾	BHKM1730JU	—	—	—	16.989	17.000	23.972	23.993	35	—
	25	14	—	7.30	7.90	11 000 ¹⁾	BKM172514UH-1	—	—	—	16.989	17.000	24.991 ⁴⁾	25.012 ⁴⁾	18	—
	25	15	—	10.9	13.1	20 000	BKM172515	—	—	—	16.989	17.000	24.991 ⁴⁾	25.012 ⁴⁾	20	—
	25	16.70	—	7.30	7.90	11 000 ¹⁾	17BKM2517JBUUH	—	—	—	16.989	17.000	24.972	24.993	20	—
	25	18	—	10.9	13.1	11 000 ¹⁾	BKM172518UH	—	—	—	16.989	17.000	24.991 ⁴⁾	25.012 ⁴⁾	24	—
25	20	—	12.9	16.3	11 000 ¹⁾	BKM172520UH-1	—	—	—	16.989	17.000	24.991 ⁴⁾	25.012 ⁴⁾	27	—	
18	24	12	9.6	10.8	19.2	6 900	—	—	18BM2412	18MM2412	17.989	18.000	23.972	23.993	17	20
	24	12	—	7.90	10.9	20 000	18BTM2412	—	—	—	17.989	18.000	23.991 ⁴⁾	24.012 ⁴⁾	12	—
	24	16	13.7	16.5	29.1	6 900	—	—	18BM2416	18MM2416	17.989	18.000	23.972	23.993	18	21
	24	16	—	17.2	30.7	6 900	—	—	18YM2416	—	17.989	18.000	23.972	23.993	19	—
	24	16	—	11.1	16.8	20 000	BTM182416	—	—	—	17.989	18.000	23.972	23.993	17	—
	25	13	—	9.40	11.8	19 000	BTM1813	—	—	—	17.989	18.000	24.972	24.993	15	—
	25	15	—	10.4	9.25	19 000	BTM1815	—	—	—	17.989	18.000	24.972	24.993	18	—
	25	17	—	12.2	17.7	19 000	BTM1817A	—	—	—	17.989	18.000	24.991 ⁴⁾	25.012 ⁴⁾	20	—
	25	19	—	14.4	20.5	19 000	BTM1819	—	—	—	17.989	18.000	24.972	24.993	22	—
	25	20	17.3	15.2	22.1	19 000	BTM182520	MKM1820	—	—	17.989	18.000	24.972	24.993	24	27
25	25	—	18.9	29.2	19 000	BTM1825A	—	—	—	17.989	18.000	24.972	24.993	29	—	
19	27	20	—	17.0	23.4	18 000	BHTM1920	—	—	—	18.987	19.000	26.972	26.993	30	—

[Notes] 1) The limiting speeds shown above are applicable when oil seal is used and the bearing is lubricated with grease.

2) FN in bearing number indicates a bearing comprising polyamide molded cage.

3) The recommended dimensional tolerances of shaft shown above are applicable except h6.

4) The recommended dimensional tolerances of housing bore shown above are applicable except N7.

[Remark] Limiting speed of grease lubrication should be kept to under 60 % of that for oil lubrication.

Drawn cup needle roller bearings

F_w 19.50 ~ (22) mm

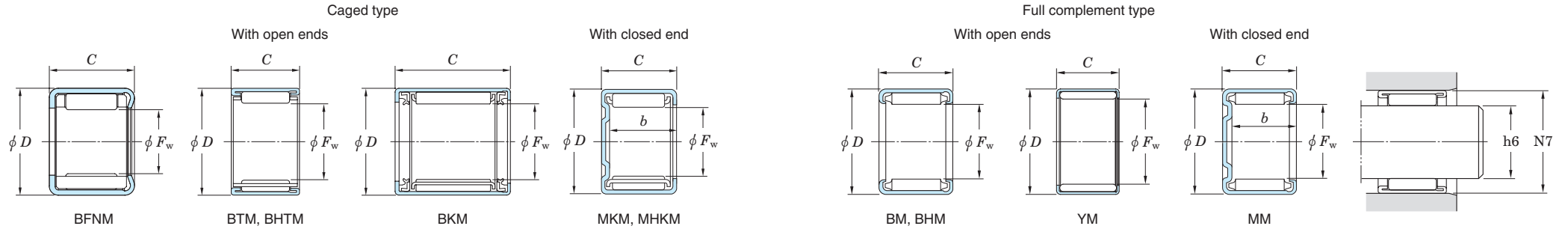

F_w	Boundary dimensions (mm)			Basic load ratings (kN)		Limiting speeds (min ⁻¹) Oil lub.	Bearing No. ²⁾				Recommended dimensions (mm)				(Refer.) Mass (g)		
	D	C	b min.	C_r	C_{0r}		Caged type		Full complement type		Shaft dia. (h6)		Housing bore dia. (N7)		With open ends	With closed end	
							With open ends	With closed end	With open ends	With closed end	min.	max.	min.	max.			
19.50	29	20	—	18.8	23.6	17 000	20BTM2920	—	—	—	19.487	19.500	28.972	28.993	36	—	
20	26	12	9.6	10.6	20.4	6 300	—	—	20BM2612	20MM2612	19.987	20.000	25.972	25.993	15	17	
	26	12	9.3	8.50	12.6	18 000	20BTM2612	20MKM2612	—	—	19.987	20.000	25.972	25.993	14	16	
	26	14	—	15.1	31.4	6 300	—	—	YM202614	—	19.987	20.000	25.972	25.993	19	—	
	26	16	13.7	14.8	31.4	6 300	—	—	20BM2616	20MM2616	19.987	20.000	25.972	25.993	21	23	
	26	16	13.3	12.4	20.3	18 000	BTM202616	20MKM2616	—	—	19.987	20.000	25.972	25.993	19	21	
	26	20	17.2	18.8	42.5	6 300	—	—	20BM2620	20MM2620	19.987	20.000	25.972	25.993	26	30	
	26	20	—	15.2	26.4	18 000	20BTM2620A	—	—	—	—	19.987	20.000	25.972	25.993	24	—
	27	13	10.6	13.1	22.2	6 200	—	—	BM2013	MM2013	19.987	20.000	26.972	26.993	18	21	
	27	15	—	15.6	27.7	6 200	—	—	BM2015	—	19.987	20.000	26.972	26.993	22	—	
	27	15	—	13.1	18.7	18 000	BTM2015	—	—	—	—	19.870	20.000	26.972	26.993	20	—
	27	20	17.3	17.7	27.6	18 000	BTM202720-1	MKM2020	—	—	19.987	20.000	26.972	26.993	25	28	
	27	23.50	—	18.4	28.8	10 000 ¹⁾	BKM2024JAU	—	—	—	—	19.987	20.000	26.972	26.993	32	—
	27	25	—	22.1	36.6	18 000	BTM202725	—	—	—	—	19.987	20.000	26.972	26.993	33	—
	27	26	—	18.4	28.8	10 000 ¹⁾	BKM2026JUU	—	—	—	—	19.987	20.000	26.972	26.993	33	—
	27	26	—	27.6	58.0	6 200	—	—	BM2026	—	19.987	20.000	26.972	26.993	40	—	
27	30	—	21.8	36.0	10 000 ¹⁾	BKM2030JUU	—	—	—	—	19.987	20.000	26.972	26.993	38	—	
27	30	27.3	25.4	43.8	18 000	BTM202730	MKM2030	—	—	19.987	20.000	26.972	26.993	40	45		
27	35	—	28.7	45.4	10 000 ¹⁾	BKM2035JUU	—	—	—	—	19.987	20.000	26.972	26.993	45	—	
28	20	—	17.4	22.3	17 000	20BTM2820A	—	—	—	—	19.987	20.000	27.991 ⁴⁾	28.012 ⁴⁾	31	—	
21	27	20	—	20.5	47.6	6 100	—	—	21YM2720J	—	20.987	21.000	26.972	26.993	29	—	
22	28	12	9.6	11.6	22.9	5 800	—	—	22BM2812	22MM2812	21.987	22.000	27.972	27.993	16	18	
	28	12	9.3	9.10	13.5	16 000	22BTM2812	22MKM2812	—	—	21.987	22.000	27.972	27.993	14	16	
	28	16	13.7	16.1	35.0	5 800	—	—	22BM2816	22MM2816	21.987	22.000	27.972	27.993	22	25	
	28	16	13.3	12.7	20.8	16 000	22BTM2816A	22MKM2816	—	—	21.987	22.000	27.972	27.993	19	22	
	28	20	17.2	20.3	47.2	5 800	—	—	22BM2820	22MM2820	21.987	22.000	27.972	27.993	29	32	

[Notes] 1) The limiting speeds shown above are applicable when oil seal is used and the bearing is lubricated with grease.

2) FN in bearing number indicates a bearing comprising polyamide molded cage.

3) The recommended dimensional tolerances of shaft shown above are applicable except h6.

4) The recommended dimensional tolerances of housing bore shown above are applicable except N7.

[Remark] Limiting speed of grease lubrication should be kept to under 60 % of that for oil lubrication.

Drawn cup needle roller bearings

F_w (22) ~ (25) mm

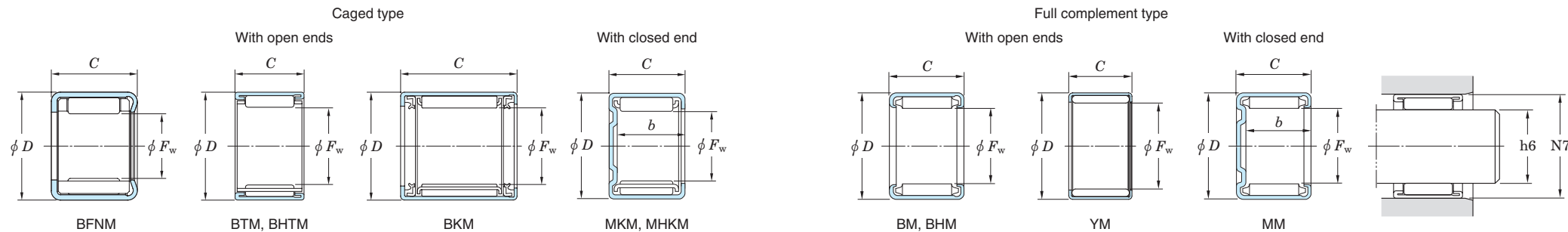

F_w	Boundary dimensions (mm)			Basic load ratings (kN)		Limiting speeds (min ⁻¹) Oil lub.	Bearing No. ²⁾				Recommended dimensions (mm)				(Refer.) Mass (g)	
	D	C	b min.	C _r	C _{0r}		Caged type		Full complement type		Shaft dia. (h6)		Housing bore dia. (N7)		With open ends	With closed end
							With open ends	With closed end	With open ends	With closed end	min.	max.	min.	max.		
22	28	20	17.3	14.9	26.5	17 000	22BTM2820	22MKM2820	—	—	21.987	22.000	27.972	27.993	25	28
	28	20	—	21.0	49.5	5 800	—	—	YM222820	—	21.987	22.000	27.972	27.993	30	—
	29	12	—	9.22	13.0	16 000	BTM2212	—	—	—	21.987	22.000	28.972	28.993	19	—
	29	15	—	12.0	18.3	16 000	BTM2215	—	—	—	21.987	22.000	28.972	28.993	22	—
	29	20	—	21.9	45.2	5 700	—	—	BM2220B	—	21.987	22.000	28.972	28.993	33	—
	29	20	17.3	16.2	26.7	16 000	BTM2220A	MKM2220	—	—	21.987	22.000	28.972	28.993	30	33
	29	25	—	20.4	36.1	16 000	BTM2225	—	—	—	21.987	22.000	28.972	28.993	37	—
	30	18	—	16.7	24.5	16 000	22BTM3018	—	—	—	21.987	22.000	29.972	29.993	31	—
24	30	13	—	9.55	15.7	15 000	BTM243013J	—	—	—	23.987	24.000	29.991 ⁴⁾	30.012 ⁴⁾	47	—
	31	20	17.3	17.7	29.4	15 000	BTM2420	MKM2420	—	—	23.987	24.000	30.967	30.992	31	35
	31	25	—	31.6	65.4	5 200	—	—	BM2425A	—	23.987	24.000	30.989 ⁴⁾	31.014 ⁴⁾	45	—
	31	28	—	23.9	43.0	15 000	BTM2428	—	—	—	23.987	24.000	30.967	30.992	44	—
	35	20	18.0	21.0	25.8	14 000	—	24MKM3520	—	—	23.987	24.000	34.967	34.992	—	52
25	31	19	—	16.3	30.1	15 000	25BTM3119A	—	—	—	24.987	25.000	30.967	30.992	26	—
	32	12	9.3	9.05	12.4	14 000	BTM2512	MKM2512	—	—	24.987	25.000	31.967	31.992	19	21
	32	16	—	18.7	37.9	5 100	—	—	BM2516	—	24.987	25.000	31.967	31.992	28	—
	32	16	13.3	15.3	24.6	14 000	BTM2516	MKM2516	—	—	24.987	25.000	31.967	31.992	26	30
	32	20	17.2	23.8	51.7	5 100	—	—	BM2520	MM2520	24.987	25.000	31.967	31.992	36	41
	32	20	—	19.1	32.5	14 000	BTM2520A	MTM2520M	—	—	24.987	25.000	31.967	31.992	33	—
	32	26	—	30.9	72.4	5 100	—	—	BM2526	—	24.987	25.000	31.967	31.992	48	—
	32	26	23.3	23.7	43.1	14 000	BTM2526	MKM2526	—	—	24.987	25.000	31.967	31.992	42	48
	33	10	—	8.50	10.3	14 000	BHTM2510A	—	—	—	24.987	25.000	32.989 ⁴⁾	33.014 ⁴⁾	18	—
	33	15	—	19.5	32.0	5 000	—	—	BHM2515	—	24.987	25.000	32.989 ⁴⁾	33.014 ⁴⁾	30	—
	33	15	—	13.9	19.7	14 000	BHTM2515-1	—	—	—	24.987	25.000	32.967	32.992	27	—
	33	20	17.3	19.2	29.7	14 000	BHTM2520-1	MHKM2520	—	—	24.987	25.000	32.967	32.992	37	41
	33	25	—	31.3	66.3	5 000	—	—	BHM2525	—	24.987	25.000	32.967	32.992	53	—
	33	25	—	24.5	40.6	14 000	BHTM2525	—	—	—	24.987	25.000	32.967	32.992	46	—

[Notes] 1) The limiting speeds shown above are applicable when oil seal is used and the bearing is lubricated with grease.

2) FN in bearing number indicates a bearing comprising polyamide molded cage.

3) The recommended dimensional tolerances of shaft shown above are applicable except h6.

4) The recommended dimensional tolerances of housing bore shown above are applicable except N7.

[Remark] Limiting speed of grease lubrication should be kept to under 60 % of that for oil lubrication.

Drawn cup needle roller bearings

F_w (25) ~ (30) mm

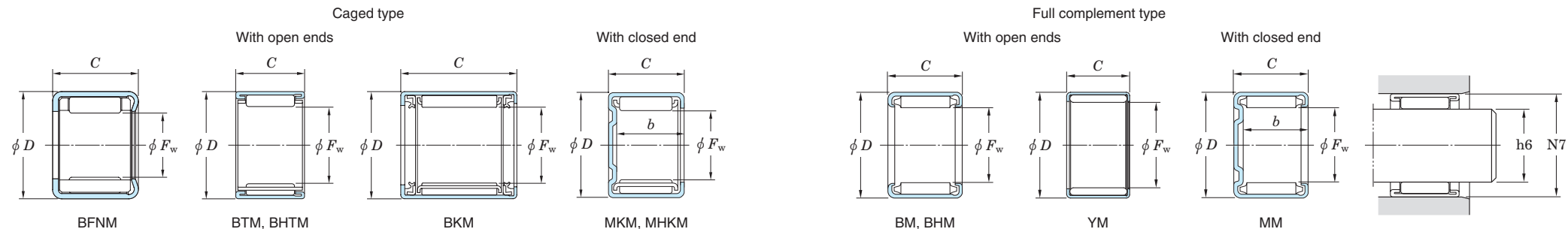

Boundary dimensions (mm)				Basic load ratings (kN)		Limiting speeds (min ⁻¹)	Bearing No. ²⁾				Recommended dimensions (mm)				(Refer.) Mass (g)	
F_w	D	C	$b_{min.}$	C_r	C_{0r}	Oil lub.	Caged type		Full complement type		Shaft dia. (h6)		Housing bore dia. (N7)		With open ends	With closed end
							With open ends	With closed end	With open ends	With closed end	min.	max.	min.	max.		
25	33	30	—	37.4	83.3	5 000	—	—	BHM2530	—	24.987	25.000	32.989 ⁴⁾	33.014 ⁴⁾	65	—
	33	30	27.3	27.7	47.4	14 000	BHTM2530-1	MHKM2530	—	—	24.987	25.000	32.967	32.992	54	61
	33	35	—	29.8	52.3	8 000 ¹⁾	BHKM2535JU	—	—	—	24.987	25.000	32.967	32.992	62	—
25.80	33	16	—	14.2	22.4	14 000	BTM263316A	—	—	—	25.787	25.800	32.967	32.992	28	—
26	31.40	12	—	8.60	14.5	14 000	BKM263112A	—	—	—	25.987	26.000	31.389 ⁴⁾	31.414 ⁴⁾	14	—
	34	16	13.3	15.3	22.5	14 000	BHTM2616	MHKM2616	—	—	25.987	26.000	33.967	33.992	30	34
	34	20	17.3	20.0	31.6	14 000	BHTM2620A	MHKM2620	—	—	25.987	26.000	33.967	33.992	38	43
28	34	17	—	16.8	49.7	4 600	—	—	BM2817	—	27.987	28.000	33.967	33.992	29	—
	34	24	—	29.0	76.7	4 600	—	—	BM2824	—	27.987	28.000	33.967	33.992	42	—
	34	25	—	34.8	85.9	4 600	—	—	YM2825B	—	27.991 ³⁾	28.000 ³⁾	33.975 ⁴⁾	34.000 ⁴⁾	45	—
	35	16	13.7	20.2	42.9	4 600	—	—	28BM3516	28MM3516	27.987	28.000	34.967	34.992	95	107
	35	16	13.3	15.9	26.2	13 000	28BTM3516	28MKM3516	—	—	27.987	28.000	34.967	34.992	28	31
	35	20	17.2	25.7	58.3	4 600	—	—	28BM3520	28MM3520	27.987	28.000	34.967	34.992	118	133
	35	20	17.3	19.0	33.1	13 000	28BTM3520	28MKM3520	—	—	27.987	28.000	34.967	34.992	35	39
	36	20.75	—	22.8	39.3	13 000	BTM283621JA	—	—	—	27.987	28.000	35.967	35.992	43	—
	36	23	—	22.8	39.3	13 000	BTM283623J	—	—	—	27.987	28.000	35.967	35.992	49	—
	37	20	17.3	21.6	33.0	13 000	BTM283720	MHKM2820	—	—	27.987	28.000	36.967	36.992	46	52
	37	30	—	43.7	94.7	4 400	—	—	28BHM3730	—	27.980 ³⁾	27.993 ³⁾	36.989 ⁴⁾	37.014 ⁴⁾	80	—
	37	30	27.3	32.8	56.5	13 000	BHTM2830	MHKM2830	—	—	27.987	28.000	36.967	36.992	70	79
	39	30	—	44.5	85.9	4 300	—	—	BM283930A	—	27.980 ³⁾	27.993 ³⁾	38.989 ⁴⁾	39.014 ⁴⁾	100	—
30	37	12	9.3	12.1	18.8	12 000	BTM303712	30MKM3712	—	—	29.987	30.000	36.967	36.992	22	25
	37	16	—	21.1	28.2	4 300	—	—	30BM3716	—	29.987	30.000	36.967	36.992	33	—
	37	16	13.3	17.1	29.3	12 000	30BTM3716BM	30MKM3716	—	—	29.987	30.000	36.967	36.992	30	33
	37	20	17.2	26.8	62.5	4 300	—	—	30BM3720	30MM3720	29.987	30.000	36.967	36.992	42	48
	37	20	17.3	20.7	40.4	12 000	30BTM3720	30MKM3720	—	—	29.987	30.000	36.967	36.992	40	45
	37	20	—	32.2	70.1	4 300	—	—	30YM3720	—	29.987	30.000	36.967	36.992	45	—

[Notes] 1) The limiting speeds shown above are applicable when oil seal is used and the bearing is lubricated with grease.
 2) FN in bearing number indicates a bearing comprising polyamide molded cage.
 3) The recommended dimensional tolerances of shaft shown above are applicable except h6.
 4) The recommended dimensional tolerances of housing bore shown above are applicable except N7.

[Remark] Limiting speed of grease lubrication should be kept to under 60 % of that for oil lubrication.

F_w (30) ~ (35) mm

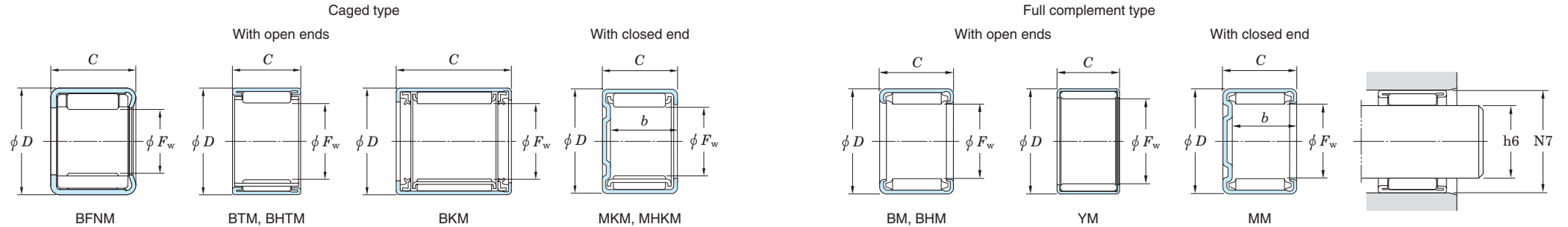

Boundary dimensions (mm)				Basic load ratings (kN)		Limiting speeds (min ⁻¹)	Bearing No. ²⁾				Recommended dimensions (mm)				(Refer.) Mass (g)	
F_w	D	C	b min.	C_r	C_{0r}	Oil lub.	Caged type		Full complement type		Shaft dia. (h6)		Housing bore dia. (N7)		With open ends	With closed end
							With open ends	With closed end	With open ends	With closed end	min.	max.	min.	max.		
30	37	26	—	34.8	87.3	4 300	—	—	30BM3726	—	29.987	30.000	36.967	36.992	56	—
	37	26	23.3	26.7	52.0	12 000	30BTM3726	30MKM3726	—	—	29.987	30.000	36.967	36.992	48	55
	37	26	—	37.1	94.9	4 300	—	—	30YM3726	—	29.987	30.000	36.967	36.992	60	—
	38	21	—	23.4	40.4	12 000	BTM3021A	—	—	—	29.987	30.000	37.967	37.992	45	—
	38	25	—	38.0	79.8	4 200	—	—	BM3025	—	29.987	30.000	37.989 ⁴⁾	38.014 ⁴⁾	62	—
	40	15	—	16.6	22.3	12 000	BHTM3015	—	—	—	29.987	30.000	39.967	39.992	41	—
	40	20	17.3	23.1	34.0	12 000	BHTM3020	MHKM3020	—	—	29.987	30.000	39.967	39.992	55	62
	40	25	—	37.3	75.4	4 100	—	—	BHM3025	—	29.987	30.000	39.987 ⁴⁾	40.013 ⁴⁾	80	—
	40	25	—	29.4	46.5	12 000	BHTM3025-1	—	—	—	29.987	30.000	39.967	39.992	69	—
	40	30	27.3	35.3	58.8	12 000	BHTM3030-1A	MHKM3030	—	—	29.987	30.000	39.967	39.992	83	94
40	30	—	30.8	49.3	6 600 ¹⁾	BKM304030JU	—	—	—	29.987	30.000	39.967	39.992	77	—	
31	39	17.80	—	20.6	34.6	12 000	31BTM3918A	—	—	—	30.984	31.000	38.967	38.992	39	—
32	38	11	—	4.90	6.75	12 000	32BTM3811A	—	—	—	31.975 ³⁾	31.991 ³⁾	38.000 ⁴⁾	38.025 ⁴⁾	15	—
	40	20	—	31.9	73.3	4 000	—	—	32YM4020P	—	31.984	32.000	39.989 ⁴⁾	40.014 ⁴⁾	56	—
	40	25	—	27.6	50.8	11 000	32BTM4025PL	—	—	—	31.984	32.000	39.989 ⁴⁾	40.014 ⁴⁾	57	—
	42	20	17.3	23.4	34.8	11 000	BHTM3220A	MHKM3220	—	—	31.984	32.000	41.989 ⁴⁾	42.014 ⁴⁾	57	64
	42	20	—	37.4	69.1	3 900	—	—	YM3220	—	31.995 ³⁾	32.011 ³⁾	41.989 ⁴⁾	42.014 ⁴⁾	71	—
	42	30	27.3	36.6	61.9	11 000	BHTM3230	MHKM3230	—	—	31.984	32.000	41.967	41.992	86	98
42	30	—	55.0	113	3 900	—	—	YM3230	—	31.995 ³⁾	32.011 ³⁾	41.989 ⁴⁾	42.014 ⁴⁾	109	—	
33.50	40	17	—	16.8	33.5	11 000	BTM344017A	—	—	—	33.484	33.500	39.967	39.992	34	—
34	40	12	—	7.30	11.7	11 000	34BTM4012A	—	—	—	33.984	34.000	39.967	39.992	20	—
	42	25	—	37.2	94.1	3 800	—	—	34YM4225	—	33.959 ³⁾	33.975 ³⁾	41.967	41.992	74	—
35	40.50	26	—	22.7	56.0	11 000	BSM354126AJ	—	—	—	34.984	35.000	40.467	40.492	44	—
	42	12	—	13.3	22.8	11 000	BTM3512	—	—	—	34.984	35.000	41.967	41.992	26	—
	42	16	—	22.2	52.9	3 700	—	—	BM3516	—	34.984	35.000	41.967	41.992	38	—

[Notes] 1) The limiting speeds shown above are applicable when oil seal is used and the bearing is lubricated with grease.
 2) FN in bearing number indicates a bearing comprising polyamide molded cage.
 3) The recommended dimensional tolerances of shaft shown above are applicable except h6.
 4) The recommended dimensional tolerances of housing bore shown above are applicable except N7.

[Remark] Limiting speed of grease lubrication should be kept to under 60 % of that for oil lubrication.

Drawn cup needle roller bearings

F_w (35) ~ (40) mm

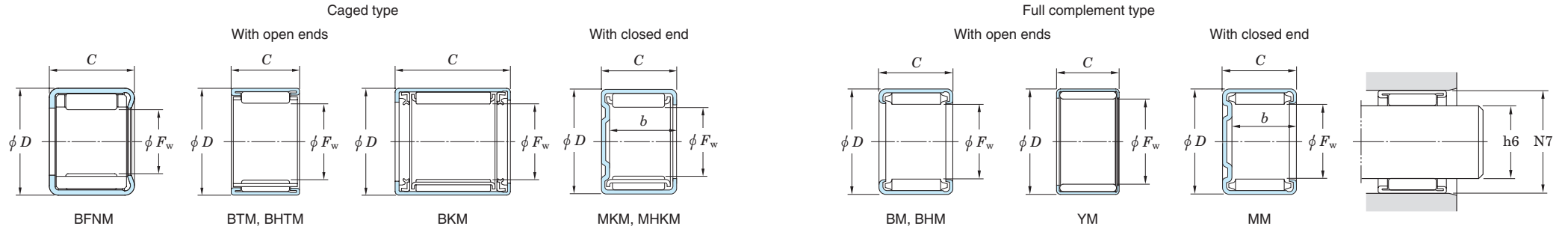

Boundary dimensions (mm)				Basic load ratings (kN)		Limiting speeds (min ⁻¹)	Bearing No. ²⁾				Recommended dimensions (mm)				(Refer.) Mass (g)	
F_w	D	C	b _{min.}	C_r	C_{0r}		Oil lub.	Caged type		Full complement type		Shaft dia. (h6)		Housing bore dia. (N7)		With open ends
							With open ends	With closed end	With open ends	With closed end	min.	max.	min.	max.		
35	42	16	13.3	18.5	34.7	11 000	BTM3516	MKM3516	—	—	34.984	35.000	41.967	41.992	35	39
	42	20	—	13.3	22.8	5 700 ¹⁾	BKM354220-1UU	—	—	—	34.984	35.000	41.967	41.992	38	—
	42	20	17.2	28.2	72.2	3 700	—	—	BM3520	MM3520	34.984	35.000	41.967	41.992	49	56
	42	20	17.3	23.4	47.0	11 000	BTM3520	MKM3520	—	—	34.984	35.000	41.989 ⁴⁾	42.014 ⁴⁾	43	49
	42	21	—	28.8	79.2	3 700	—	—	YM3521A	—	34.984	35.000	41.989 ⁴⁾	42.014 ⁴⁾	55	—
	42	26	—	36.7	101	3 700	—	—	BM3526	—	34.984	35.000	41.967	41.992	66	—
	42	26	23.3	30.1	65.2	11 000	BTM3526	MKM3526	—	—	34.984	35.000	41.967	41.992	57	64
	42	28	—	31.3	68.6	11 000	BTM3528	—	—	—	34.984	35.000	41.967	41.992	63	—
	42	46	—	26.2	57.5	5 700 ¹⁾	BKM354246UUH	—	—	—	34.984	35.000	41.967	41.992	101	—
	45	15	—	18.4	26.6	10 000	BHTM3515	—	—	—	34.984	35.000	44.967	44.992	47	—
	45	18	—	20.5	33.4	3 600	—	—	BHM3518	—	34.984	35.000	44.967	44.992	62	—
	45	20	17.3	26.0	41.7	10 000	BHTM3520	MHKM3520	—	—	34.984	35.000	44.967	44.992	64	72
45	25	—	32.8	56.2	10 000	BHTM3525	—	—	—	34.984	35.000	44.967	44.992	80	—	
45	30	27.3	39.4	71.0	10 000	BHTM3530	MHKM3530	—	—	34.984	35.000	44.967	44.992	96	109	
36	42	16	—	19.6	55.9	3 700	—	—	36BM4216	—	35.984	36.000	41.967	41.992	35	—
	44	25	—	42.0	99.2	3 600	—	—	36YM4425L	—	35.975 ³⁾	35.991 ³⁾	43.967	43.992	78	—
	48	24	—	33.2	48.7	9 800	36BTM4824	—	—	—	35.984	36.000	47.967	47.992	95	—
37	43	12	—	8.00	13.6	10 000	37BTM4312A	—	—	—	36.984	37.000	42.967	42.992	23	—
	47	20	17.3	25.1	39.9	9 800	BTM3720	MKM3720	—	—	36.984	37.000	46.967	46.992	64	72
	47	30	27.3	38.2	68.4	9 800	BTM3730	MKM3730	—	—	36.984	37.000	46.967	46.992	96	109
38	45	12	—	12.7	23.0	9 800	BTM384512A	—	—	—	37.984	38.000	44.967	44.992	29	—
	48	20	17.3	27.1	44.5	9 500	BTM3820A	MKM3820	—	—	37.984	38.000	47.967	47.992	67	76
	48	20	—	42.0	82.8	3 300	—	—	YM3820P	—	37.984	38.000	47.967	47.992	82	—
	48	30	27.3	41.2	76.2	9 500	BTM3830PL	MKM3830	—	—	37.984	38.000	47.967	47.992	102	115
	48	45	—	58.9	121	9 500	BTM3845-OH	—	—	—	37.984	38.000	47.967	47.992	151	—
40	47	12	—	9.75	10.4	9 400	40BTM4712A	—	—	—	39.984	40.000	46.967	46.992	27	—

[Notes] 1) The limiting speeds shown above are applicable when oil seal is used and the bearing is lubricated with grease.

2) FN in bearing number indicates a bearing comprising polyamide molded cage.

3) The recommended dimensional tolerances of shaft shown above are applicable except h6.

4) The recommended dimensional tolerances of housing bore shown above are applicable except N7.

[Remark] Limiting speed of grease lubrication should be kept to under 60 % of that for oil lubrication.

Drawn cup needle roller bearings

F_w (40) ~ 45 mm

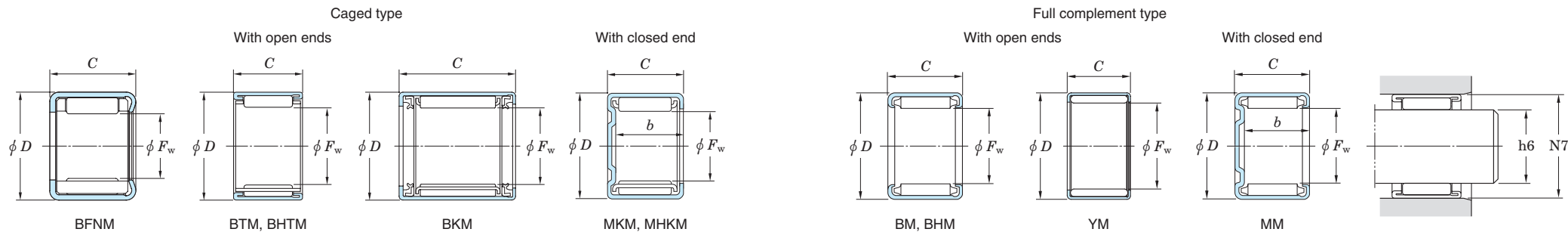

Boundary dimensions (mm)				Basic load ratings (kN)		Limiting speeds (min ⁻¹)	Bearing No. ²⁾				Recommended dimensions (mm)				(Refer.) Mass (g)	
F_w	D	C	b min.	C_r	C_{0r}	Oil lub.	Caged type		Full complement type		Shaft dia. (h6)		Housing bore dia. (N7)		With open ends	With closed end
							With open ends	With closed end	With open ends	With closed end	min.	max.	min.	max.		
40	47	16	—	23.8	60.5	3 300	—	—	40BM4716	—	39.984	40.000	46.967	46.992	43	—
	47	16	13.3	18.7	37.1	9 400	40BTM4716	40MKM4716	—	—	39.984	40.000	46.967	46.992	39	44
	47	20	17.2	30.3	82.6	3 300	—	—	40BM4720	40MM4720	39.984	40.000	46.967	46.992	56	63
	47	20	17.3	23.7	50.4	9 400	40BTM4720	40MKM4720	—	—	39.984	40.000	46.967	46.992	48	55
	50	15	—	23.4	45.2	3 200	—	—	BM4015-1	—	39.984	40.000	49.967	49.992	55	—
	50	15	—	20.2	31.2	9 100	BTM4015	—	—	—	39.984	40.000	49.967	49.992	54	—
	50	20	17.3	28.5	48.5	9 100	BTM4020	MKM4020	—	—	39.984	40.000	49.967	49.992	73	82
	50	25	—	36.2	66.2	9 100	BTM4025	—	—	—	39.984	40.000	49.967	49.992	91	—
	50	30	27.3	43.0	82.5	9 100	BTM4030-1	MKM4030	—	—	39.984	40.000	49.967	49.992	109	123
	50	40	—	54.8	113	9 100	BTM4040-OH	—	—	—	39.984	40.000	49.967	49.992	141	—
	51	20	—	40.2	84.7	3 200	—	—	YM405120J	—	39.984	40.000	50.961	50.991	96	—
	51	30	—	43.5	76.6	9 000	40BTM5130J	—	—	—	39.984	40.000	50.961	50.991	112	—
	53	20	—	46.7	87.3	3 100	—	—	YM405320JM	—	39.984	40.000	52.961	52.991	114	—
41.50	46.50	8.50	—	7.00	13.9	9 200	BTM424709AJ	—	—	—	41.484	41.500	46.467	46.492	15	—
42	53	30	—	45.7	83.9	8 600	BTM425330J	—	—	—	41.984	42.000	52.961	52.991	121	—
43	49	12	—	8.35	15.1	8 800	43BTM4912A	—	—	—	42.984	43.000	48.989 ⁴⁾	49.014 ⁴⁾	25	—
43.52	48.52	14	—	12.0	29.0	8 800	44BTM4914A	—	—	—	43.504	43.520	48.487	48.512	28	—
45	52	12	—	13.7	26.9	8 400	45BTM5212A	—	—	—	44.984	45.000	51.961	51.991	34	—
	52	16	—	23.8	65.9	2 900	—	—	45BM5216	—	44.984	45.000	51.961	51.991	49	—
	52	16	13.3	19.1	41.3	8 400	45BTM5216	45MKM5216	—	—	44.984	45.000	51.961	51.991	45	51
	52	20	17.2	30.4	90.1	2 900	—	—	45BM5220	45MM5220	44.984	45.000	51.961	51.991	62	71
	52	20	17.3	23.3	33.4	8 200	45BTM5220A	MKM4520	—	—	44.984	45.000	54.961	54.991	79	90
	52	30	27.3	45.3	91.7	8 200	BTM4530	MKM4530	—	—	44.984	45.000	54.961	54.991	120	136
	55	20	—	30.0	53.9	8 200	BTM4520A	—	—	—	44.984	45.000	54.961	54.991	79	—

[Notes] 1) The limiting speeds shown above are applicable when oil seal is used and the bearing is lubricated with grease.
 2) FN in bearing number indicates a bearing comprising polyamide molded cage.
 3) The recommended dimensional tolerances of shaft shown above are applicable except h6.
 4) The recommended dimensional tolerances of housing bore shown above are applicable except N7.

[Remark] Limiting speed of grease lubrication should be kept to under 60 % of that for oil lubrication.

Drawn cup needle roller bearings

F_w 48 ~ 76.50 mm

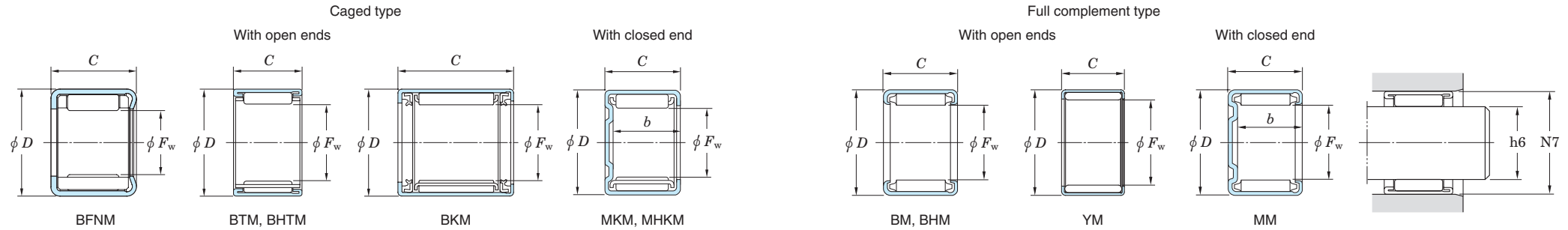

Boundary dimensions (mm)				Basic load ratings (kN)		Limiting speeds (min ⁻¹) Oil lub.	Bearing No. ²⁾				Recommended dimensions (mm)				(Refer.) Mass (g)	
F_w	D	C	$b_{\text{min.}}$	C_r	C_{0r}		Caged type		Full complement type		Shaft dia. (h6)		Housing bore dia. (N7)		With open ends	With closed end
							With open ends	With closed end	With open ends	With closed end	min.	max.	min.	max.		
48	56	30	—	41.0	100	7 800	BTM485630J	—	—	—	47.984	48.000	55.961	55.991	102	—
50	58	16	—	21.9	43.8	7 500	BTM505816J	—	—	—	49.984	50.000	57.961	57.991	54	—
	58	20	—	35.8	98.0	2 600	—	—	50BM5820	—	49.984	50.000	57.961	57.991	78	—
	58	20	17.3	28.4	61.0	7 500	50BTM5820J	50MKM5820	—	—	49.984	50.000	57.961	57.991	68	76
	58	25	—	45.2	133	2 600	—	—	50BM5825	—	49.984	50.000	57.961	57.991	98	—
	58	25	22.3	35.9	82.5	7 500	50BTM5825	50MKM5825	—	—	49.984	50.000	57.961	57.991	86	97
	62	15	—	24.3	36.4	7 300	BTM5015	—	—	—	49.984	50.000	61.961	61.991	73	—
	62	20	17.3	34.5	57.1	7 300	BTM5020	MKM5020	—	—	49.984	50.000	61.961	61.991	99	112
	62	25	—	43.9	77.8	7 300	BTM5025	—	—	—	49.984	50.000	61.961	61.991	125	—
62	30	27.3	52.8	98.5	7 300	BTM5030	MKM5030	—	—	49.984	50.000	61.961	61.991	153	173	
55	63	20	—	29.1	65.1	6 900	55BTM6320	—	—	—	54.981	55.000	62.961	62.991	73	—
	67	20	—	36.4	63.1	6 700	55BTM6720A	—	—	—	54.981	55.000	66.961	62.991	110	—
64	73.178	21.10	—	36.1	83.8	5 900	64BTM7321A	—	—	—	63.981	64.000	73.139	73.129	110	—
66	72	16	—	21.9	61.1	5 900	BTM667216J	—	—	—	65.981	66.000	71.961	71.991	54	—
71.60	78.60	15	—	22.9	61.9	5 400	BTM727915AJ	—	—	—	71.581	71.600	78.561	78.591	66	—
76.50	83.50	15	—	23.5	65.4	5 000	BTM778415AJ	—	—	—	76.481	76.500	83.455	83.490	70	—

[Notes] 1) The limiting speeds shown above are applicable when oil seal is used and the bearing is lubricated with grease.

2) FN in bearing number indicates a bearing comprising polyamide molded cage.

3) The recommended dimensional tolerances of shaft shown above are applicable except h6.

4) The recommended dimensional tolerances of housing bore shown above are applicable except N7.

[Remark] Limiting speed of grease lubrication should be kept to under 60 % of that for oil lubrication.

Machined ring needle roller bearings

F_w 12 ~ 17 mm

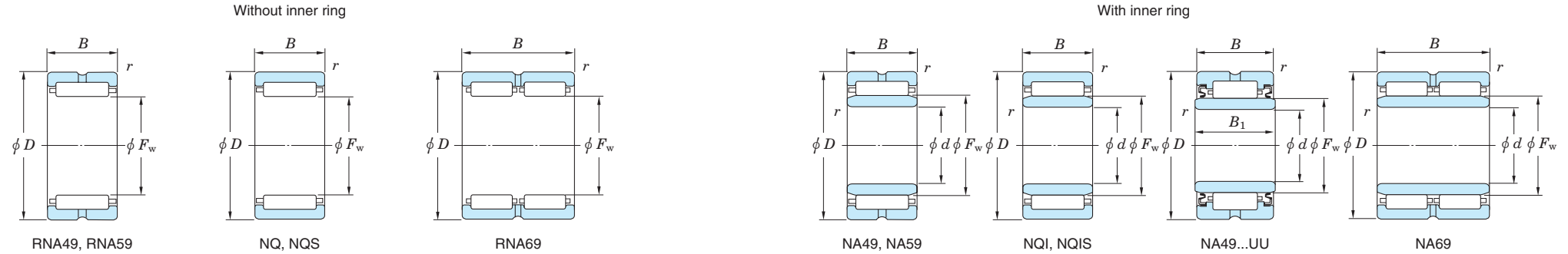

Boundary dimensions (mm)						Basic load ratings (kN)		Limiting speeds ¹⁾ (min ⁻¹)	Bearing No.	Mounting dimensions (mm)			(Refer.) Mass (kg)		(Refer.) Applicable inner ring No.			
F_w	d	D	B	B_1	$r_{min.}$	C_r	C_{0r}	Oil lub.		Without inner ring	With inner ring	d_a min.	D_a max.	r_a max.		Without inner ring	With inner ring	
12	—	19	10	—	0.3	5.9	6.3	35 000	NQ12/10 12NQ2410A	—	—	17	0.3	0.010	—			
	—	24	9.8	—	0.3	5.9	6.3	35 000		—	—	—	22	0.3	0.023	—		
14	10	22	13	14	0.3	7.5	7.7	14 000	—	NA4900UU NA4900 NA4900R	12	20	0.3	—	0.025	IRM101414 IRM101413 IRM101413		
	10	22	13	—	0.3	7.6	9.1	31 000	—		12	20	0.3	0.017	0.025			
	10	22	13	—	0.3	9.3	10.1	30 000	—		12	20	0.3	0.016	0.023			
	—	22	16	—	0.5	11.7	13.7	30 000	NQ14/16D		—	—	19	0.5	0.021		—	
15	—	23	12	—	0.3	8.8	9.7	29 000	NQ15/12	—	—	21	0.3	0.017	—	—		
	—	24	10	—	0.3	8.5	8.2	28 000	15NQ2410D	—	—	22	0.3	0.016	—			
	—	25	12	—	0.6	10.5	10.8	28 000	NQ152512	—	—	21	0.6	0.022	—			
	—	26	16	—	0.3	13.4	14.8	28 000	NQS15/16	—	—	24	0.3	0.034	—			
—	28	15	—	1	7.9	9.8	28 000	15NQ2815	—	—	23	1	0.043	—	—			
16	—	23	16	—	0.5	13.1	16.4	27 000	16NQ2316	—	—	20	0.5	0.018	—	—		
	—	23	16	—	0.5	15.2	17.4	28 000	NQ15/16B	—	—	20	0.5	0.020	—			
	—	23	22	—	0.5	17.1	23.0	27 000	16NQ2322A	—	—	20	0.5	0.025	—			
	—	24	12	—	0.3	7.7	9.6	28 000	NQ16/12	—	—	22	0.3	0.019	—			
	12	24	13	14	0.3	8.3	9.2	12 000	—	NA4901UU NA4901	14	22	0.3	—	0.028		IRM121614 IRM121613	
	12	24	13	—	0.3	8.6	11.1	28 000	RNA4901		—	14	22	0.3	0.019			0.028
	12	24	13	—	0.3	10.2	11.8	27 000	RNA4901R	NA4901R	14	22	0.3	0.018	0.027		IRM121613	
	—	24	16	—	0.3	10.9	15.2	28 000	NQ16/16D	—	—	22	0.3	0.025	—		—	
	12	24	16	16	0.3	10.9	15.2	28 000	—	NQ112/16D	—	14	22	0.3	—		0.036	—
	—	24	20	—	0.3	13.1	19.1	28 000	NQ16/20	—	—	22	0.3	0.032	—		—	
12	24	22	—	0.3	16.3	21.7	27 000	RNA6901	NA6901	14	22	0.3	0.030	0.045	IRM121622			
17	—	25	16	—	0.5	11.3	16.2	26 000	NQ17/16D	—	—	22	0.5	0.026	—	—		
	—	25	20	—	0.3	13.7	20.6	26 000	17NQ2520	—	—	23	0.3	0.033	—			
	—	30	13	—	0.3	10.0	10.5	25 000	17NQ3013D	—	—	28	0.3	0.041	—			
	—	32	16	—	0.6	18.0	16.5	23 000	17NQ3216D	—	—	28	0.6	0.053	—			

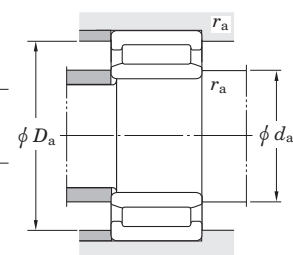

[Note] 1) Limiting speeds of bearing number NA49...UU indicates the value of sealed and grease lubricated bearings.
 [Remark] Limiting speed of grease lubrication should be kept to under 60 % of that for oil lubrication.

Machined ring needle roller bearings

F_w 18 ~ (22) mm

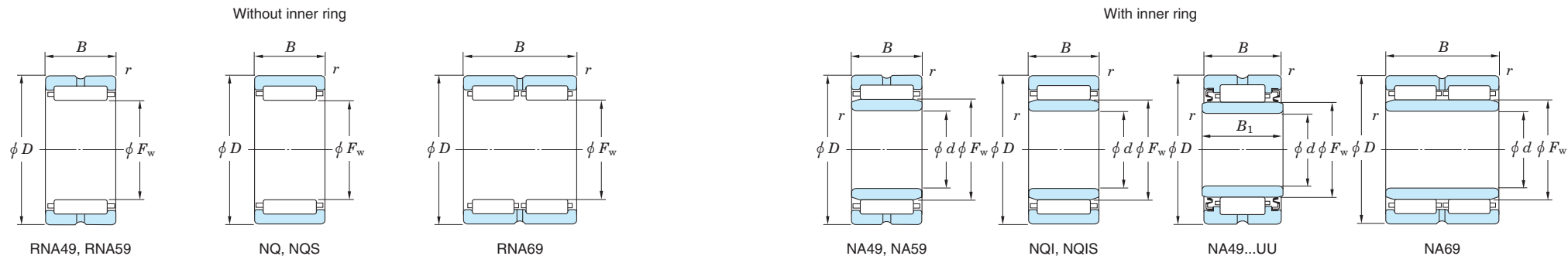

Boundary dimensions (mm)						Basic load ratings (kN)		Limiting speeds ¹⁾ (min ⁻¹)	Bearing No.	Mounting dimensions (mm)	(Refer.) Mass (kg)		(Refer.)			
F_w	d	D	B	B_1	$r_{min.}$	C_r	C_{0r}	Oil lub.	Without inner ring	With inner ring	d_a min.	D_a max.	r_a max.	Without inner ring	With inner ring	Applicable inner ring No.
18	—	25	16	—	0.3	11.7	17.2	25 000	18NQ2516	—	—	23	0.3	0.023	—	—
	—	26	13	—	0.3	11.0	13.6	24 000	RNA49/14R	—	—	24	0.3	0.020	—	—
	—	26	16	—	0.3	11.7	17.2	25 000	NQ18/16	—	—	24	0.3	0.027	—	—
	—	26	20	—	0.3	14.1	21.7	25 000	NQ18/20	—	—	24	0.3	0.035	—	—
	—	28	19	—	0.3	16.9	20.9	24 000	18NQ2819	—	—	26	0.3	0.042	—	—
	12	30	16	—	0.3	13.7	14.3	23 000	NQS18/16	NQIS12/16	14	28	0.3	0.044	0.057	—
19	15	27	16	—	0.3	12.1	18.2	24 000	—	NQI15/16	17	25	0.3	0.042	—	—
20	—	27	17	—	0.3	14.7	20.4	22 000	20NQ2717	—	—	25	0.3	0.024	—	—
	15	28	13	14	0.3	9.2	11.1	10 000	—	NA4902UU	17	26	0.3	—	0.037	IRM152014
	15	28	13	—	0.3	9.2	12.8	23 000	RNA4902	NA4902	17	26	0.3	0.023	0.036	IRM152013
	15	28	13	—	0.3	11.3	14.6	22 000	RNA4902R	NA4902R	17	26	0.3	0.021	0.035	IRM152013
	—	28	16	—	0.3	12.0	18.2	23 000	NQ20/16D	—	—	26	0.3	0.030	—	—
	15	28	18	—	0.3	14.7	20.4	22 000	RNA5902	NA5902	17	26	0.3	0.029	0.048	IRM152018
	—	28	20	—	0.3	14.4	23.0	23 000	NQ20/20	—	—	26	0.3	0.038	—	—
	—	28	23	—	0.3	18.4	27.1	22 000	NQ202823	—	—	26	0.3	0.040	—	—
	—	30	20	—	0.3	19.8	26.4	22 000	20NQ3020	—	—	28	0.3	0.048	—	—
	—	32	12	—	0.3	11.9	11.3	21 000	20NQ3212	—	—	30	0.3	0.033	—	—
—	32	18	—	0.3	21.0	26.1	21 000	NQ203218	—	—	30	0.3	0.053	—	—	
21	—	33	15	—	0.6	14.0	16.9	21 000	20NQ3315D	—	—	29	0.6	0.052	—	—
	—	34	18	—	0.6	21.1	20.8	20 000	20NQ3418D	—	—	30	0.6	0.060	—	—
	—	38	17	—	0.6	21.1	21.1	19 000	21NQ3817	—	—	34	0.6	0.082	—	—
	22	17	30	13	14	0.3	9.4	11.8	9 100	—	NA4903UU	19	28	0.3	—	0.040
17		30	13	—	0.3	9.6	14.0	21 000	RNA4903D	NA4903	19	28	0.3	0.025	0.040	IRM172213
17		30	13	—	0.3	12.1	16.4	20 000	RNA4903R	NA4903R	19	28	0.3	0.023	0.038	IRM172213
—		30	16	—	0.3	12.7	20.2	21 000	NQ22/16	—	—	28	0.3	0.032	—	—
17		30	18	—	0.3	15.2	21.9	20 000	RNA5903	NA5903	19	28	0.3	0.031	0.052	IRM172218
—		30	20	—	0.3	15.3	25.6	21 000	NQ22/20	—	—	28	0.3	0.040	—	—

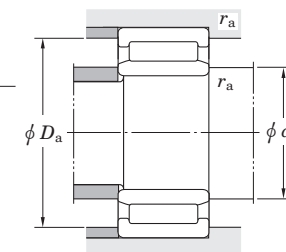

[Note] 1) Limiting speeds of bearing number NA49...UU indicates the value of sealed and grease lubricated bearings.
 [Remark] Limiting speed of grease lubrication should be kept to under 60 % of that for oil lubrication.

Machined ring needle roller bearings

F_w (22) ~ 28 mm

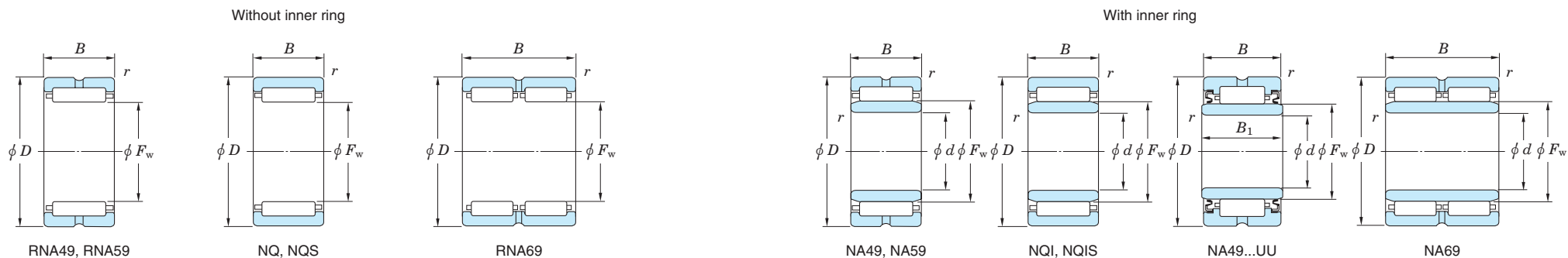

F_w	Boundary dimensions (mm)					Basic load ratings (kN)		Limiting speeds ¹⁾ (min ⁻¹) Oil lub.	Bearing No.	Mounting dimensions (mm)	(Refer.) Mass (kg)		(Refer.) Applicable inner ring No.			
	d	D	B	B_1	$r_{min.}$	C_r	C_{0r}				Without inner ring	With inner ring		d_a min.	D_a max.	r_a max.
22	17	30	23	—	0.3	18.9	29.0	20 000	RNA6903 22NQ3225	NA6903 —	19	28	0.3	0.040	0.067	IRM172223 —
	—	32	25	—	0.3	22.4	31.7	20 000			—	30	0.3	0.063	—	
24	20	32	12	—	0.3	9.6	14.4	19 000	NQ24/12 NQ24/16 NQ24/20AD	NQI20/12 NQI20/16 —	22	30	0.3	0.025	0.038	— —
	—	32	20	—	0.3	17.3	26.5	19 000			—	30	0.3	0.035	0.052	
	—	32	20	—	0.3	17.3	26.5	19 000	—	NQI203220AD	22	30	0.3	—	0.062	20IRM2420AD
	20	32	20	20	0.3	17.3	26.5	19 000	—	—	22	30	0.3	—	0.062	—
25	—	33	16	—	0.3	14.1	20.6	18 000	NQ25/16 NQ25/20	— —	—	31	0.3	0.034	—	— —
	—	33	20	—	0.3	18.9	30.0	18 000			—	31	0.3	0.043	—	
	20	37	14	—	0.3	17.1	19.1	17 000	—	20NQI3714	22	35	0.3	—	0.066	—
	—	37	17	—	1	19.3	22.5	17 000	25NQ3717AD-1	—	—	—	32	1	0.056	—
	20	37	17	18	0.3	16.4	18.2	8 000	—	NA4904UU NA4904	22	35	0.3	—	0.078	IRM202518
	20	37	17	—	0.3	15.9	21.1	18 000	RNA4904	NA4904	22	35	0.3	0.058	0.081	IRM202517
	—	37	17	—	0.9	21.5	25.7	17 000	RNA4904ARD-1	—	—	—	32	0.9	0.054	—
	20	37	23	—	0.3	28.0	36.1	17 000	RNA5904	NA5904	22	35	0.3	0.073	0.104	IRM202523
20	37	30	—	0.3	35.4	48.9	17 000	RNA6904	NA6904	22	35	0.3	0.096	0.137	IRM202530	
26	22	34	16	—	0.3	14.1	24.2	18 000	NQ26/16 26NQ3420	NQI22/16 —	24	32	0.3	0.037	0.056	— —
	—	34	20	—	0.3	14.2	28.9	18 000			—	—	32	0.3	0.042	
	—	47	17	—	0.6	21.4	23.6	16 000	26NQ4717	—	—	43	0.6	0.113	—	
	—	52	14	—	0.6	18.0	18.9	16 000	26NQ5214	—	—	48	0.6	0.136	—	
28	—	37	20	—	0.3	20.6	34.7	16 000	NQ283720D NQ28/30	— —	—	35	0.3	0.056	—	— —
	—	37	30	—	0.3	29.1	54.1	16 000			—	—	35	0.3	0.083	
	22	39	17	—	0.3	17.8	25.4	16 000	RNA49/22	NA49/22	24	37	0.3	0.056	0.086	IRM222817
	—	39	17	—	0.3	21.8	29.8	16 000	RNA49/22R	—	—	—	37	0.3	0.055	—
	22	39	30	—	0.3	36.8	53.1	16 000	RNA69/22	NA69/22	24	37	0.3	0.100	0.154	IRM222830
	—	40	17	—	0.3	15.1	27.4	16 000	28NQ4017	—	—	—	38	0.3	0.068	—
	—	40	20	—	0.3	20.6	34.7	16 000	28NQ4020	—	—	—	38	0.3	0.087	—

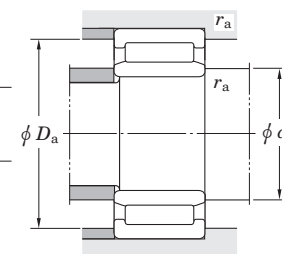

[Note] 1) Limiting speeds of bearing number NA49...UU indicates the value of sealed and grease lubricated bearings.
 [Remark] Limiting speed of grease lubrication should be kept to under 60 % of that for oil lubrication.

Machined ring needle roller bearings

F_w 29 ~ 37 mm

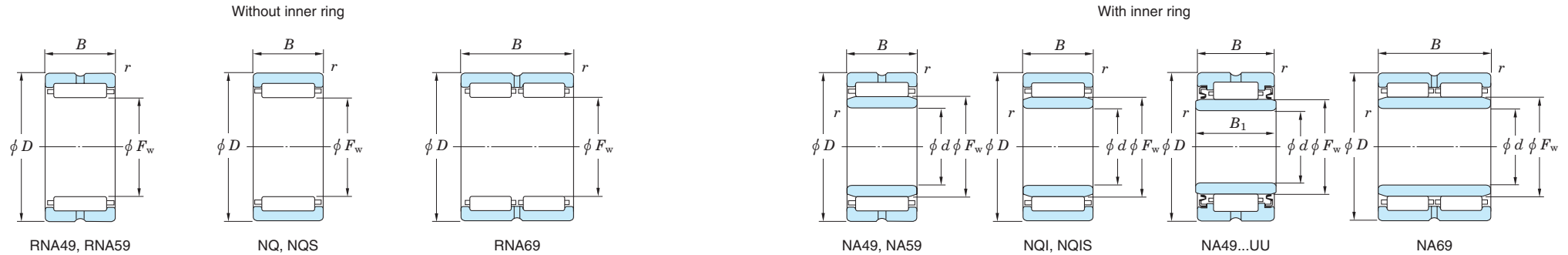

Boundary dimensions (mm)						Basic load ratings (kN)		Limiting speeds ¹⁾ (min ⁻¹)	Bearing No.	Mounting dimensions (mm)			(Refer.) Mass (kg)		(Refer.) Applicable inner ring No.
F_w	d	D	B	B_1	r min.	C_r	C_{0r}	Oil lub.		Without inner ring	With inner ring	d_a min.	D_a max.	r_a max.	
29	25	38	15	—	0.6	14.6	22.6	16 000	—	NQI25/15	29	34	0.6	—	0.061
	—	38	20	—	0.6	20.4	34.8	16 000	NQ29/20	—	—	34	0.6	0.056	—
	25	38	30	—	0.3	28.9	54.3	16 000	NQ29/30	NQI25/30	27	36	0.3	0.085	0.125
30	—	40	20	—	0.3	23.7	37.5	15 000	NQ30/20	—	—	38	0.3	0.066	—
	—	40	30	—	0.3	33.5	58.5	15 000	NQ30/30	—	—	38	0.3	0.099	—
	25	42	17	18	0.3	18.4	22.4	6 600	—	NA4905UU	27	40	0.3	—	0.092
	25	42	17	—	0.3	18.6	27.4	15 000	RNA4905	NA4905	27	40	0.3	0.065	0.096
	25	42	17	—	0.3	24.2	31.7	15 000	RNA4905R	NA4905R	27	40	0.3	0.065	0.092
	25	42	23	—	0.3	31.7	44.9	15 000	RNA5905	NA5905	27	40	0.3	0.085	0.124
	—	42	30	—	0.6	40.1	60.7	15 000	NQ304230	—	—	38	0.6	0.116	—
	25	42	30	—	0.3	40.1	60.7	15 000	RNA6905	NA6905	27	40	0.3	0.112	0.162
	25	44	25	25.5	0.3	36.0	48.8	14 000	—	25NQI4425A	27	42	0.3	—	0.161
32	28	42	20	—	0.3	24.3	39.4	14 000	NQ32/20	NQI28/20	30	40	0.3	0.070	0.098
	28	42	30	—	0.3	34.4	61.6	14 000	NQ32/30	NQI28/30	30	40	0.3	0.104	0.141
	28	45	17	—	0.3	25.0	33.8	14 000	RNA49/28R	NA49/28R	30	43	0.3	0.075	0.099
	25	47	22	—	0.3	31.2	41.4	14 000	NQS32/22	NQIS25/22	27	45	0.3	0.123	0.167
35	—	45	14	—	0.6	16.9	29.0	13 000	NQ354514	—	—	41	0.6	0.055	—
	30	45	20	—	0.3	24.7	41.4	13 000	—	NQI30/20	32	43	0.3	—	0.108
	30	47	17	18	0.3	19.5	25.3	5 700	—	NA4906UU	32	45	0.3	—	0.105
	30	47	17	17	0.3	20.0	31.6	13 000	RNA4906D	NA4906D	32	45	0.3	0.081	0.114
	30	47	17	—	0.3	26.4	34.4	13 000	RNA4906R	NA4906R	32	45	0.3	0.070	0.103
	30	47	23	—	0.3	33.8	51.0	13 000	RNA5906	NA5906	32	45	0.3	0.096	0.141
	—	47	30	—	0.3	42.7	69.0	13 000	RNA6906	—	—	45	0.3	0.131	—
	—	48	24	—	0.3	33.9	51.3	13 000	35NQ4824D	—	—	46	0.3	0.123	—
37	32	47	20	—	0.3	26.0	45.1	13 000	NQ37/20	NQI32/20	34	45	0.3	0.079	0.114
	—	47	20	—	0.3	26.0	45.1	13 000	NQ37/20D	—	—	45	0.3	0.079	—

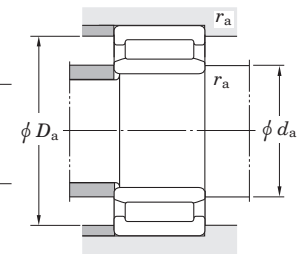

[Note] 1) Limiting speeds of bearing number NA49...UU indicates the value of sealed and grease lubricated bearings.
 [Remark] Limiting speed of grease lubrication should be kept to under 60 % of that for oil lubrication.

Machined ring needle roller bearings

F_w 38 ~ 48 mm

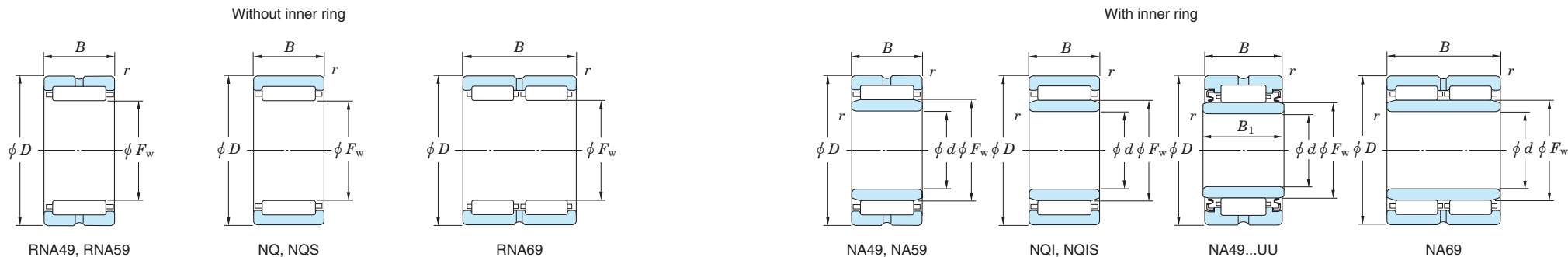

Boundary dimensions (mm)						Basic load ratings (kN)		Limiting speeds ¹⁾ (min ⁻¹)	Bearing No.	Mounting dimensions (mm)			(Refer.) Mass (kg)		(Refer.) Applicable inner ring No.	
F_w	d	D	B	B_1	$r_{min.}$	C_r	C_{0r}	Oil lub.		Without inner ring	With inner ring	d_a min.	D_a max.	r_a max.		Without inner ring
38	—	47	20	—	0.3	23.6	45.8	12 000	38NQ4720 38NQ5235	—	—	45	0.3	0.073	—	
	—	52	35	—	1	49.3	84.7	12 000		—	—	—	47	1	0.203	—
40	—	48	20	—	0.3	20.9	39.8	12 000	NQ404820 NQ40/15AD NQ40/20 NQ40/30 RNA49/32R-1 40NQ5230	—	—	—	46	0.3	0.064	—
	—	50	15	—	0.3	21.0	35.1	12 000		—	—	—	48	0.3	0.063	—
	35	50	20	—	0.3	27.2	48.8	12 000		NQI35/20	37	48	0.3	0.085	0.129	—
	35	50	30	—	0.3	39.8	79.8	12 000		NQI35/30	37	48	0.3	0.120	0.192	—
	—	52	20	—	0.6	31.9	49.3	11 000		—	—	—	48	0.6	0.098	—
	—	52	30	—	0.6	47.0	81.0	11 000		—	—	—	48	0.6	0.148	—
42	—	52	20	—	0.6	28.6	53.3	11 000	NQ425220D — RNA4907 RNA4907R RNA5907 RNA6907	—	—	—	48	0.6	0.087	—
	35	55	20	21	0.6	29.0	40.9	4 700		NA4907UU NA4907	39	51	0.6	—	0.173	IRM354221
	35	55	20	—	0.6	26.9	49.0	11 000		NA4907	39	51	0.6	0.122	0.186	IRM354220
	35	55	20	—	0.6	35.1	52.2	11 000		NA4907R	39	51	0.6	0.104	0.168	IRM354220
	35	55	27	—	0.6	42.9	67.6	11 000		NA5907	39	51	0.6	0.138	0.225	IRM354227
	35	55	36	—	0.6	51.4	85.1	11 000		NA6907	39	51	0.6	0.182	0.297	IRM354236
43	38	53	30	30	0.6	41.3	85.9	10 000	—	NQI38/30	—	51	0.6	—	0.205	—
45	—	55	20	—	0.6	27.9	52.7	10 000	NQ45/20 NQ45/30 RNA49/38R-1	—	—	—	51	0.6	0.100	—
	40	55	30	—	0.6	40.9	86.1	10 000		NQI40/30	44	51	0.6	0.138	0.214	—
	—	58	20	—	0.6	36.0	55.0	10 000		—	—	—	54	0.6	0.116	—
47	42	57	20	—	0.6	29.0	56.4	10 000	—	NQI42/20	46	53	0.6	—	0.143	—
	42	57	30	—	0.6	44.0	96.1	10 000	—	NQI42/30	46	53	0.6	—	0.219	—
48	40	62	22	23	0.6	35.7	51.7	4 100	— RNA4908 RNA4908R-2 RNA5908 RNA6908	NA4908UU NA4908	44	58	0.6	—	0.235	IRM404823
	40	62	22	—	0.6	32.6	58.5	9 700		NA4908	44	58	0.6	0.157	0.249	IRM404822
	—	62	22	—	0.6	43.2	66.1	9 400		—	—	—	58	0.6	0.142	—
	40	62	30	—	0.6	55.5	91.2	9 400		NA5908	44	58	0.6	0.187	0.313	IRM404830
	40	62	40	—	0.6	66.7	115.0	9 400		NA6908	44	58	0.6	0.256	0.415	IRM404840

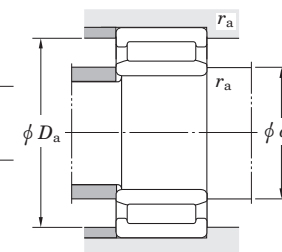

[Note] 1) Limiting speeds of bearing number NA49...UU indicates the value of sealed and grease lubricated bearings.
 [Remark] Limiting speed of grease lubrication should be kept to under 60 % of that for oil lubrication.

Machined ring needle roller bearings

F_w 50 ~ 63 mm

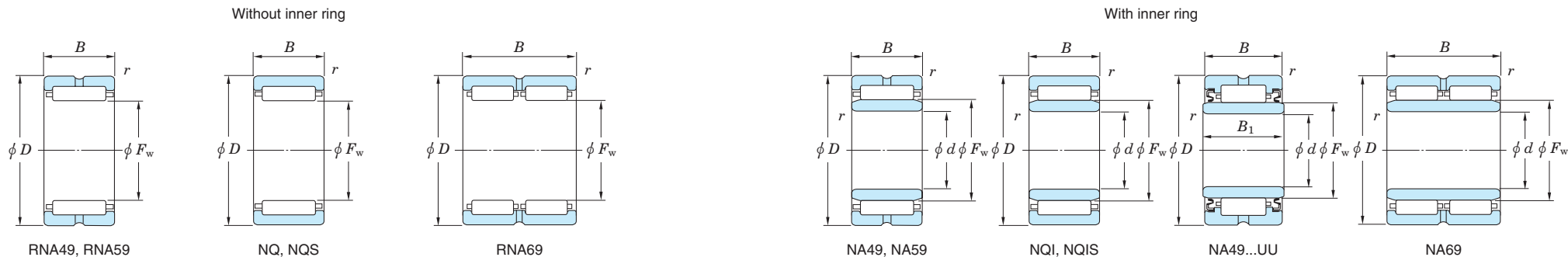

Boundary dimensions (mm)						Basic load ratings (kN)		Limiting speeds ¹⁾ (min ⁻¹)	Bearing No.	Mounting dimensions (mm)			(Refer.) Mass (kg)		(Refer.) Applicable inner ring No.	
F_w	d	D	B	B_1	$r_{min.}$	C_r	C_{0r}	Oil lub.		Without inner ring	With inner ring	d_a min.	D_a max.	r_a max.		Without inner ring
50	—	62	20	—	0.6	24.8	46.0	9 400	NQ50/20A	—	—	58	0.6	0.126	—	—
	45	62	25	—	0.6	41.9	82.5	9 300	—	NQI45/25	49	58	0.6	—	0.223	—
	45	62	35	—	0.6	58.2	126.0	9 300	—	NQI45/35	49	58	0.6	—	0.316	—
	—	65	25	—	0.6	48.3	77.8	9 100	NQ506525	—	—	61	0.6	0.190	—	—
52	45	68	22	23	0.6	37.7	56.8	3 800	—	NA4909UU	49	64	0.6	—	0.285	IRM455223
	45	68	22	—	0.6	33.2	61.9	9 000	RNA4909	NA4909	49	64	0.6	0.205	0.294	IRM455222
	45	68	22	—	0.6	45.8	72.9	8 800	RNA4909R	NA4909R	49	64	0.6	0.185	0.274	IRM455222
	45	68	30	—	0.6	58.9	101.0	8 800	RNA5909	NA5909	49	64	0.6	0.252	0.365	IRM455230
	45	68	40	—	0.6	70.7	127.0	8 800	RNA6909	NA6909	49	64	0.6	0.334	0.496	IRM455240
53	—	68	24.5	—	0.6	47.1	81.7	8 700	NQ536825A	—	—	64	0.6	0.207	—	—
55	—	67	20	—	0.6	24.1	46.2	8 600	55NQ6720A	—	—	63	0.6	0.136	—	—
	50	68	25	—	0.6	47.4	90.4	8 500	—	NQI50/25	54	64	0.6	—	0.255	—
	—	70	22	—	0.6	46.9	76.5	8 300	RNA49/48R	—	—	66	0.6	0.174	—	—
	—	72	14	—	0.6	12.5	19.6	8 600	55NQ7214	—	—	68	0.6	0.149	—	—
	45	72	22	—	0.6	44.6	71.6	8 300	NQS55/22	NQIS45/22	49	68	0.6	0.210	0.341	—
58	50	72	22	—	0.6	35.7	70.6	8 100	RNA4910	NA4910	54	68	0.6	0.191	0.298	IRM505822
	50	72	22	—	0.6	48.0	80.0	7 900	RNA4910R	NA4910R	54	68	0.6	0.172	0.276	IRM505822
	50	72	30	—	0.6	61.6	110.0	7 900	RNA5910	NA5910	54	68	0.6	0.221	0.375	IRM505830
	50	72	40	—	0.6	74.0	140.0	7 900	RNA6910	NA6910	54	68	0.6	0.291	0.497	IRM505840
60	—	72	25	—	0.6	45.4	97.3	7 900	NQ60/25	—	—	68	0.6	0.164	—	—
	—	75	22	—	0.6	49.1	83.4	7 700	RNA49/52R	—	—	71	0.6	0.188	—	—
63	55	80	25	—	1	44.4	87.2	7 500	RNA4911	NA4911	60	75	1	0.287	0.428	IRM556325
	55	80	25	—	1	58.4	99.0	7 300	RNA4911R	NA4911R	60	75	1	0.260	0.401	IRM556325
	55	80	34	—	1	75.6	138.0	7 300	RNA5911	NA5911	60	75	1	0.354	0.546	IRM556334
	55	80	45	—	1	86.7	165.0	7 300	RNA6911	NA6911	60	75	1	0.458	0.711	IRM556345

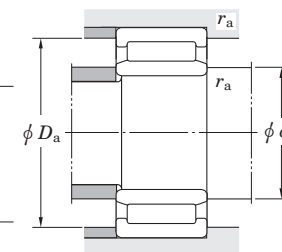

[Note] 1) Limiting speeds of bearing number NA49...UU indicates the value of sealed and grease lubricated bearings.
 [Remark] Limiting speed of grease lubrication should be kept to under 60 % of that for oil lubrication.

Machined ring needle roller bearings

F_w 65 ~ 105 mm

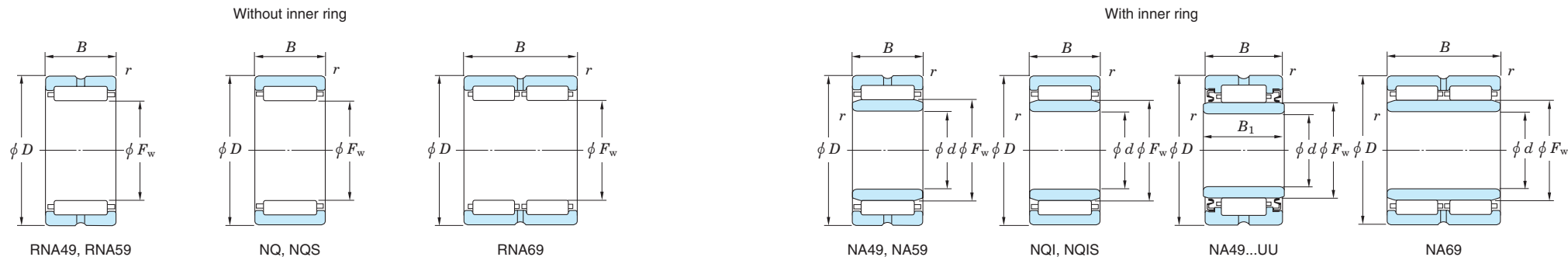

Boundary dimensions (mm)						Basic load ratings (kN)		Limiting speeds ¹⁾ (min ⁻¹)	Bearing No.	Mounting dimensions (mm)			(Refer.) Mass (kg)		(Refer.) Applicable inner ring No.	
F_w	d	D	B	B_1	$r_{min.}$	C_r	C_{0r}	Oil lub.		Without inner ring	With inner ring	d_a min.	D_a max.	r_a max.		Without inner ring
65	—	82	25	—	1	59.9	103.0	7 100	RNA49/58R	—	—	77	1	0.277	—	—
68	60	85	25	—	1	45.8	93.3	6 900	RNA4912	NA4912	65	80	1	0.310	0.459	IRM606825
	60	85	34	—	1	79.2	150.0	6 800	RNA5912	NA5912	65	80	1	0.380	0.587	IRM606834
70	—	88	25	—	1	64.5	109.0	6 600	RNA49/62	—	—	83	1	0.298	—	—
72	65	90	25	—	1	66.1	114.0	6 400	RNA4913	NA4913	70	85	1	0.307	0.450	IRM657225
	65	90	34	—	1	85.4	158.0	6 400	RNA5913	NA5913	70	85	1	0.419	0.613	IRM657234
	65	90	45	—	1	98.4	190.0	6 400	RNA6913	NA6913	70	85	1	0.541	0.798	IRM657245
75	—	95	30	—	1	82.3	145.0	6 100	RNA49/68	—	—	90	1	0.437	—	—
80	70	100	30	—	1	86.4	157.0	5 700	RNA4914	NA4914	75	95	1	0.483	0.733	IRM708030
	70	100	40	—	1	107.0	207.0	5 700	RNA5914	NA5914	75	95	1	0.615	0.973	IRM708040
	70	100	54	—	1	132.0	271.0	5 700	RNA6914	NA6914	75	95	1	0.895	1.37	IRM708054
85	75	105	30	—	1	88.0	164.0	5 400	RNA4915	NA4915	80	100	1	0.507	0.773	IRM758530
	75	105	40	—	1	109.0	216.0	5 400	RNA5915	NA5915	80	100	1	0.644	1.03	IRM758540
	75	105	54	—	1	135.0	283.0	5 400	RNA6915	NA6915	80	100	1	0.866	1.44	IRM758554
90	80	110	30	—	1	91.6	176.0	5 100	RNA4916	NA4916	85	105	1	0.540	0.819	IRM809030
	80	110	40	—	1	114.0	232.0	5 100	RNA5916	NA5916	85	105	1	0.681	1.09	IRM809040
	80	110	54	—	1	140.0	304.0	5 100	RNA6916	NA6916	85	105	1	0.916	1.46	IRM809054
95	—	115	30	—	1.1	92.8	183.0	4 900	RNA49/82	—	—	108.5	1	0.537	—	—
100	85	120	35	—	1.1	110.0	230.0	4 600	RNA4917	NA4917	91.5	113.5	1	0.669	1.25	IRM8510035
	85	120	46	—	1.1	126.0	293.0	4 700	RNA5917	NA5917	91.5	113.5	1	0.952	1.65	IRM8510046
	85	120	63	—	1.1	165.0	390.0	4 600	RNA6917	NA6917	91.5	113.5	1	1.17	2.29	IRM8510063
105	90	125	35	—	1.1	111.0	238.0	4 400	RNA4918	NA4918	96.5	118.5	1	0.695	1.31	IRM9010535
	90	125	46	—	1.1	137.0	311.0	4 400	RNA5918	NA5918	96.5	118.5	1	0.898	1.70	IRM9010546
	90	125	63	—	1.1	167.0	403.0	4 400	RNA6918	NA6918	96.5	118.5	1	1.21	2.31	IRM9010563

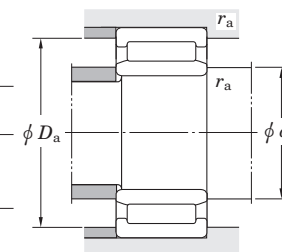

[Note] 1) Limiting speeds of bearing number NA49...UU indicates the value of sealed and grease lubricated bearings.
 [Remark] Limiting speed of grease lubrication should be kept to under 60 % of that for oil lubrication.

Machined ring needle roller bearings

F_w 110 ~ 160 mm

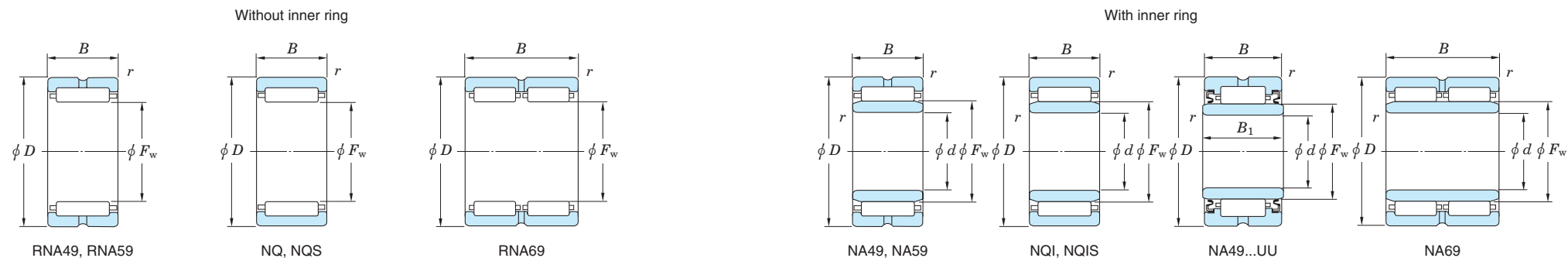

F_w	Boundary dimensions (mm)					Basic load ratings (kN)		Limiting speeds ¹⁾ (min ⁻¹) Oil lub.	Bearing No.		Mounting dimensions (mm)			(Refer.) Mass (kg)		(Refer.) Applicable inner ring No.
	d	D	B	B_1	$r_{min.}$	C_r	C_{or}		Without inner ring	With inner ring	d_a min.	D_a max.	r_a max.	Without inner ring	With inner ring	
110	95	130	35	—	1.1	115.0	253.0	4 200	RNA4919	NA4919	101.5	123.5	1	0.728	1.37	IRM9511035 IRM9511046 IRM9511063
	95	130	46	—	1.1	141.0	331.0		RNA5919	NA5919	101.5	123.5	1	0.940	1.78	
	95	130	63	—	1.1	173.0	428.0		RNA6919	NA6919	101.5	123.5	1	1.27	2.43	
115	100	140	40	—	1.1	144.0	296.0	4 000	RNA4920	NA4920	106.5	133.5	1	1.160	1.86	IRM10011540 IRM10011554
	100	140	54	—	1.1	189.0	418.0		RNA5920	NA5920	106.5	133.5	1	1.49	2.53	
125	110	150	40	—	1.1	149.0	317.0	3 700	RNA4922	NA4922	116.5	143.5	1	1.17	2.01	IRM11012540 IRM11012554
	110	150	54	—	1.1	195.0	448.0		RNA5922	NA5922	116.5	143.5	1	1.690	2.74	
135	120	165	45	—	1.1	192.0	398.0	3 400	RNA4924	NA4924	126.5	158.5	1	1.75	2.78	IRM12013545 IRM12013560
	120	165	60	—	1.1	244.0	564.0		RNA5924	NA5924	126.5	158.5	1	2.43	3.80	
150	130	180	50	—	1.5	225.0	508.0	3 000	RNA4926	NA4926	138	172	1.5	2.21	3.83	IRM13015050 IRM13015067
	130	180	67	—	1.5	274.0	655.0		RNA5926	NA5926	138	172	1.5	3.000	5.09	
160	140	190	50	—	1.5	232.0	540.0	2 800	RNA4928	NA4928	148	182	1.5	2.350	4.08	IRM14016050 IRM14016067
	140	190	67	—	1.5	283.0	696.0		RNA5928	NA5928	148	182	1.5	3.02	5.42	

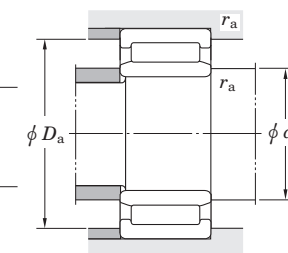

[Note] 1) Limiting speeds of bearing number NA49...UU indicates the value of sealed and grease lubricated bearings.
 [Remark] Limiting speed of grease lubrication should be kept to under 60 % of that for oil lubrication.

Needle roller thrust bearings

$d (d_1)$ **10 ~ 22.2 mm**

Separable type

Non-separable type

Needle roller and cage thrust assembly

Race

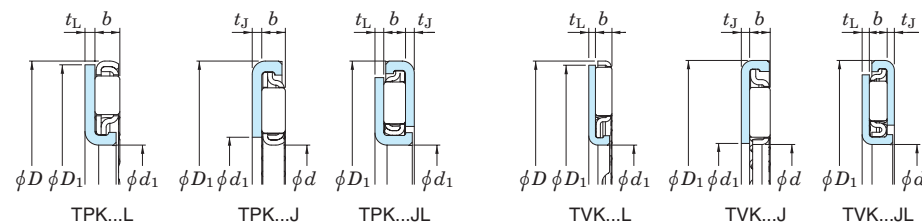
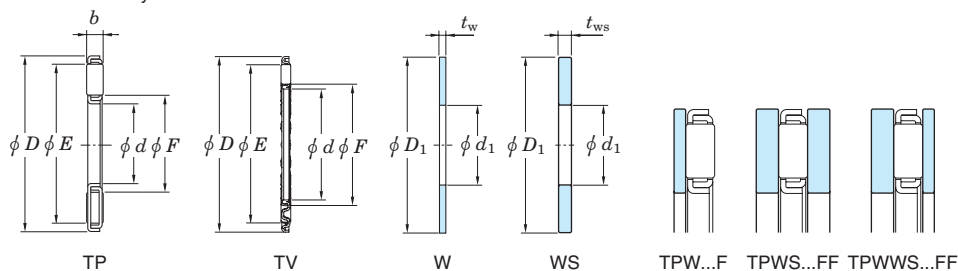

Boundary dimensions (mm)									Basic load ratings (kN)		Limiting speeds (min ⁻¹)	Bearing No.			Dimensions (mm)		(Refer.) Mass (g)				
d	d_1	D	D_1	b	t_w	t_J	t_{ws}	t_L	C_a	C_{0a}	Oil lub.	Needle roller and cage thrust ass'y Separable type	Thin plate race (pressed)	Thick plate race (machined)	E	F	(TP TV)	(TPK TVK)	(W)	(WS)	
10	10	24	24	2	1.0	—	2	—	6.35	18.3	12 000	TP1024-1	—	W1024F	WS1024F	15.2	21.8	3.5	—	2.9	5.8
	—	23	—	2	—	—	—	—	8	24	12 000	TV1023	—	—	—	12.6	21.8	2.5	—	—	—
12	—	24	—	2	—	—	—	—	3.75	9	12 000	TP1224	—	—	—	14.1	22.1	3.0	—	—	—
	12	25.8	26	2	1.0	—	2	—	6.55	19.79	11 000	TP1226B	—	W1226F	WS1226F	17.3	23.5	3.6	—	3.3	6.6
	12	26	26	2	1.0	—	2	—	8.6	27.5	11 000	TV1226	—	W1226F	WS1226BF	14.6	23.8	3.8	—	3.3	6.6
14	14	27	27	2	1	—	2.75	—	6.55	19.8	11 000	TP1427	—	W1427F	WS1427F	24.5	16.5	3.6	—	3.2	9.0
15	15	32.3	32	2	1.0	—	—	—	11	42.1	10 000	TP1532-1	—	W1532F	—	22.3	30.3	6.1	—	4.6	—
	15	28	28	2	1.0	—	2	—	9.85	34.3	11 000	TV1528	—	W1528F	WS1528F	17.6	26.8	4.1	—	3.4	6.8
16	16	29	29	2	1.5	—	2.75	—	9.15	31.4	11 000	TP1629	—	W1629AF	WS1629F	26.5	18.5	4.4	—	5.4	9.9
17	17	30	30	2	0.8	—	2.75	—	9.40	32.9	10 000	TP1730	—	W1730F	WS1730F	27.5	19.5	4.4	—	3.0	10
	17	40	40	2.5	—	—	3	—	17.9	69.3	8 000	TP1740	—	—	WS1740F	36.5	22.7	11	—	—	24
	17	34	34	2.5	—	—	2.155	—	14.1	49.5	8 700	TV1734	—	—	WS1734-2F	21.1	32.5	8.2	—	—	11
18	18	31	31	2	1.0	—	2	—	9.65	34.4	10 200	TP1831	—	W1831F	WS1831F	20.4	28.4	5.0	—	3.9	7.8
—	18.1	31.6	31	2	—	—	—	0.8	7.45	25.2	10 000	—	TPK1832L	—	—	22.8	29.4	—	8	—	—
—	18.75	—	39.7	1.984	—	0.8	—	0.8	9.8	37.4	9 000	—	TVK1940JL	—	—	25	34.2	—	17	—	—
19.6	21	—	35.9	2	—	0.8	—	—	6	18.7	9 400	—	TPK2036J-1	—	—	21.8	28	—	10	—	—
20	20	35	35	2	1	—	2.75	—	13.2	53.6	9 600	TP2035-1	—	W2035F	WS2035F	32.5	22.9	5.9	—	5.1	14
20.9	—	32	—	2	—	—	—	—	8.4	29.7	10 000	TP2132D	—	—	—	23.5	29.7	4.6	—	—	—
21.9	—	34	—	2	—	—	—	—	8.05	28.6	9 700	TP2234	—	—	—	25	31.2	5.1	—	—	—
22	22	37	37	2	1	—	2.75	—	12.6	51.7	9 300	TP2237-1	—	W2237F	WS2237F	34.5	22.9	6.4	—	5.4	15
—	22	41	41	2	—	—	—	0.8	13.2	56.8	8 800	—	TPK2241L	—	—	28	38	—	15	—	—
22.2	—	36.1	—	1.984	—	—	—	—	9.95	38.2	9 500	TP2236A-1	—	—	—	25.3	33.3	6.1	—	—	—

Needle roller thrust bearings

$d (d_1)$ 22.7 ~ 32.9 mm

Separable type

Non-separable type

Needle roller and cage thrust assembly

Race

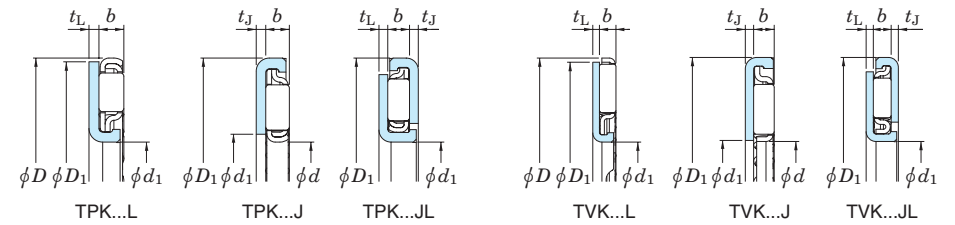
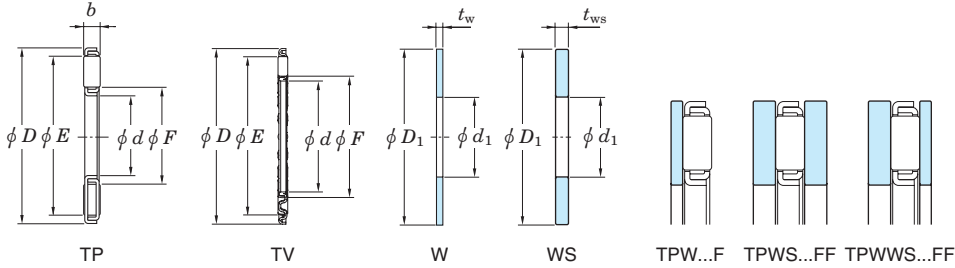

Boundary dimensions (mm)									Basic load ratings (kN)		Limiting speeds (min ⁻¹) Oil lub.	Bearing No.			Dimensions (mm)		(Refer.) Mass (g)				
d	d_1	D	D_1	b	t_w	t_J	t_{ws}	t_L	C_a	C_{0a}		Needle roller and cage thrust ass'y Separable type	Thin plate race (pressed)	Thick plate race (machined)	E	F	TP TV	TPK TVK	(W)	(WS)	
22.7	22	—	35.1	2	—	0.8	—	—	8.3	29.7	9 500	—	TPK2235J	—	—	25	31.2	—	9.1	—	—
22.8	22	—	37.95	1.984	—	0.8	—	—	10.6	40.9	9 200	—	TVK2238J	—	—	24	33.2	—	11	—	—
25	25	42	42	2	1.0	—	3	—	14.8	66.2	8 700	TP2542	—	W2542F	WS2542KF	28.6	39.2	8.6	—	7	21
	25	—	39.5	2.5	—	0.8	—	—	14	51.5	8 100	—	TVK2540J	—	—	26.2	35.4	—	12.4	—	—
25.8	26	—	42	1.984	—	0.8	—	—	12.8	54.4	8 800	—	TVK2642J	—	—	27	37	—	13	—	—
26	—	38.66	—	2	—	—	—	—	10.4	41.2	9 100	TV2639-1	—	—	—	28.2	37.4	5.5	—	—	—
	—	26	—	43.4	1.984	—	0.8	0.8	11.5	49	8 600	—	TPK2643JL	—	—	30.6	38.6	—	19	—	—
28	—	41	—	2	—	—	—	—	9.4	37.4	8 800	TP2841C	—	—	—	31.5	37.7	6.7	—	—	—
	28	45	45	2	0.8	—	3	—	15.1	70.3	8 400	TP2845	—	W2845F	WS2845F	42.5	31.9	9.0	—	6.1	19
	28	—	42.6	2	—	0.8	—	—	9.4	37.4	8 700	—	TPK2843AJ	—	—	31.5	37.7	—	13	—	—
28.5	28.5	46.15	46.15	2	0.8	—	—	—	12.1	52.4	8 300	TP2946A	—	W2946AF	—	32.4	40.4	9.3	—	6.5	—
28.9	—	42	—	1.984	—	—	—	—	11.7	50.4	8 800	TP2942A-1	—	—	—	31.6	39.6	7.2	—	—	—
—	29	47.21	47	2	—	—	—	1	15.9	76	8 300	—	TVK2947L	—	—	34	45	—	18	—	—
	—	29	48.4	49	3	—	—	0.8	21.8	87.4	6 600	—	TVK2949L	—	—	35	47	—	22	—	—
30	30	47	47	2	1.0	—	2	—	16.2	78.6	8 300	TP3047-1	—	W3047F	WS3047F	34	44.6	10	—	8.1	16.2
—	30.1	45.5	45.5	1.984	—	—	—	0.8	12.4	55.9	8 400	—	TPK3046L	—	—	35	42.6	—	14	—	—
	—	30.1	—	47.3	1.984	—	0.8	0.8	12.4	55.9	8 300	—	TPK3047JL-1	—	—	35	42.6	—	21	—	—
—	30.7	—	46.02	1.984	—	0.8	—	0.8	12.5	56.2	8 400	—	TPK3146JL-4	—	—	34.5	42.3	—	19	—	—
	—	30.7	—	46.43	1.984	—	1	—	12.5	56.2	8 300	—	TPK3146JL-5	—	—	34.5	42.3	—	21	—	—
—	31.85	45.1	45.2	1.984	—	—	—	0.8	12.1	54.7	8 400	—	TVK3245L	—	—	36.2	44.2	—	12	—	—
32	32	49	49	2	1	—	3	—	17.3	86.2	8 100	TP3249	—	W3249F	WS3249F	46.5	35.9	10	—	8.5	25
—	32.9	53.1	53.1	1.984	—	—	—	0.8	18.4	97.2	7 800	—	TVK3353L	—	—	39.8	51.8	—	20	—	—

Needle roller thrust bearings

$d (d_1)$ 33.5 ~ 45 mm

Separable type

Non-separable type

Needle roller and cage thrust assembly

Race

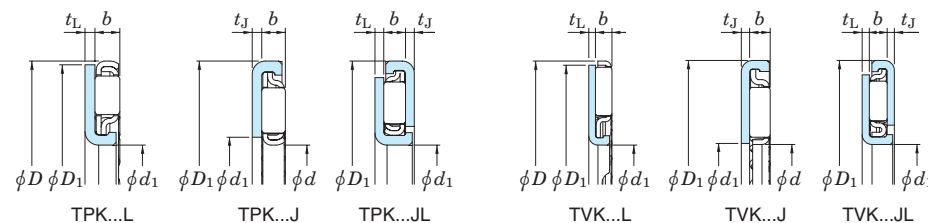
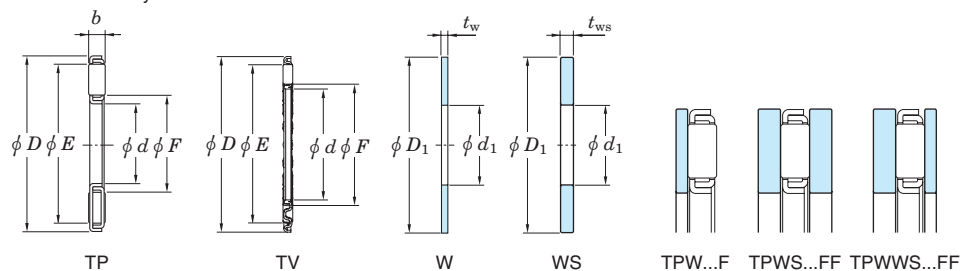

Boundary dimensions (mm)									Basic load ratings (kN)		Limiting speeds (min ⁻¹)	Bearing No.			Dimensions (mm)		(Refer.) Mass (g)				
d	d_1	D	D_1	b	t_w	t_J	t_{ws}	t_L	C_a	C_{0a}	Oil lub.	Needle roller and cage thrust ass'y Separable type	Thin plate race (pressed)	Thick plate race (machined)	E	F	$\left[\begin{smallmatrix} TP \\ TV \end{smallmatrix} \right]$	$\left[\begin{smallmatrix} TPK \\ TVK \end{smallmatrix} \right]$	(W)	(WS)	
33.5	—	45	—	2	—	—	—	—	8.5	34.3	8 400	TP3445A	—	—	37	42.6	$\left[\begin{smallmatrix} TP \\ TV \end{smallmatrix} \right]$	6.8	—	—	—
33.7	33.8	—	48.2	1.984	—	0.8	—	—	13.6	63	8 200	—	TVK3448J-1	—	—	35	44.2	—	14	—	—
—	34	—	51.4	2	—	0.8	—	0.8	12.6	58.1	7 900	—	TPK3451JL	—	—	38.6	46.6	—	23	—	—
34.65	35	52	52	2	1.0	—	3	—	17.1	86.9	7 800	TP3552B	—	W3552F	WS3552AF	38.4	49	11	—	9.1	27
—	34.6	58.4	58.2	2	0.8	—	—	—	20.5	114	7 400	TP3558	—	W3558F	—	44	56	16	—	11	—
—	34.6	58.4	58.2	2	0.8	—	—	—	22.4	128	7 400	TP3558-1	—	W3558F	—	42	56	16	—	11	—
—	37.4	57.3	57.3	1.984	—	—	—	0.8	19.3	106	7 500	—	TVK3757L	—	—	44	56	—	23	—	—
—	38	—	53	2	—	0.8	—	0.8	11.6	53.8	7 800	—	TPK3853JL	—	—	42.4	49	—	22	—	—
—	38	—	58	3	—	0.8	—	1	24.9	91.5	6 100	—	TPK3858JL	—	—	43.2	53.2	—	41	—	—
38.07	38	—	52	2	—	0.8	—	—	12	55.2	7 800	—	TVK3852J-1	—	—	39.8	47.8	—	15	—	—
38.15	38.15	55.29	55.29	1.984	0.8	—	3.0	—	19.9	108	7 600	TP3855A	—	W3855F	WS3855F	40.59	52.59	13	—	13	49
39.6	—	58.1	—	3	—	—	—	—	25.8	115	6 100	TP4058-1	—	—	—	43.3	55.3	22	—	—	—
40	40	60	60	3	1.0	—	2	—	23.5	103	6 000	TP4060	—	W4060F	WS4060F	44.4	56	23	—	12	24
41	—	68	—	9	—	—	—	—	75.8	222	3 200	TP4168	—	—	—	45.4	63.8	104	—	—	—
42	—	62	—	3	—	—	—	—	17.5	71.4	5 900	TP4262	—	—	—	47.8	56.4	23	—	—	—
—	42.5	—	61.2	1.984	—	0.8	—	0.8	15.5	81.7	7 300	—	TVK4361JL-2	—	—	47.6	56.8	—	29	—	—
—	43.45	—	61.2	1.984	—	0.8	—	0.8	14.6	74.9	7 300	—	TVK4361JL	—	—	47.6	56.8	—	29	—	—
—	43.45	—	61.74	1.984	—	1.1	—	0.8	14.6	74.9	7 200	—	TVK4362JL	—	—	47.6	56.8	—	32	—	—
45	45.24	62.19	62.2	1.984	0.8	—	2	—	20.3	115	7 200	TV4562	—	W4562F	WS4562AF	46.2	58.6	14	—	8.8	22
—	45	56	56	2	1.0	—	2	—	9	39.6	7 600	TP4556	—	W4556F	WS4556F	47.5	53.7	8.4	—	6.8	13.6
—	45	65	65	3	1.5	—	2	—	25.2	116	5 700	TP4565A	—	W4565AF	WS4565F	49.4	61	26	—	20	27

Needle roller thrust bearings

$d (d_1)$ 46.4 ~ 70.03 mm

Separable type

Non-separable type

Needle roller and cage thrust assembly

Race

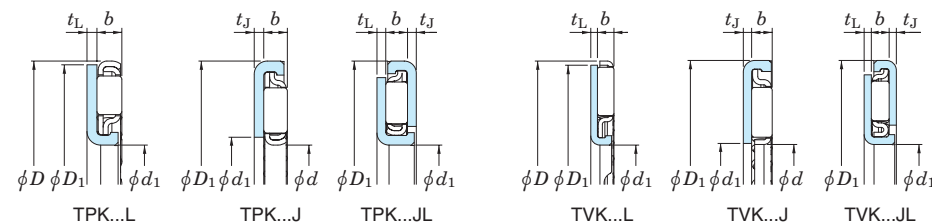
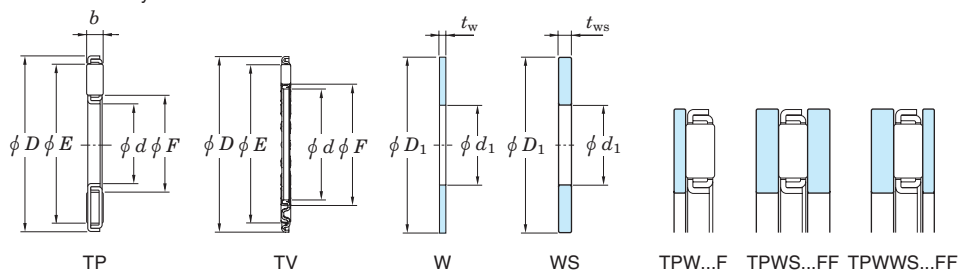

Boundary dimensions (mm)									Basic load ratings (kN)		Limiting speeds (min ⁻¹)	Bearing No.			Dimensions (mm)		(Refer.) Mass (g)			
d	d_1	D	D_1	b	t_w	t_J	t_{ws}	t_L	C_a	C_{0a}	Oil lub.	Needle roller and cage thrust ass'y Separable type	Thin plate race (pressed)	Thick plate race (machined)	E	F	$\left[\begin{smallmatrix} TP \\ TV \end{smallmatrix} \right]$	$\left[\begin{smallmatrix} TPK \\ TVK \end{smallmatrix} \right]$	(W)	(WS)
46.4	—	68	—	3.5	—	—	—	—	38.4	182	5 200	TP4668-2	—	—	49.4	65	35	—	—	—
—	48.25	—	72	3	—	0.8	—	0.8	30.9	129	5 400	—	TVK4872JL	—	—	54	66	—	56	—
49	49.1	70.65	71	1.984	0.8	—	1.84	—	18	105	6 800	TV4971	—	W4971AF WS4971F-1	58.4	68.4	17	—	13	30
50	50	70	70	3	1.0	—	2	—	26.7	129	5 500	TP5070	—	W5070F WS5070F	54.4	66	28	—	15	30
52	—	72.6	—	1.984	—	—	—	—	26	169	6 700	TV5273	—	—	56	71.2	19	—	—	—
—	53.6	—	69.6	1.984	—	0.8	—	0.8	15.9	89.3	6 800	—	TPK5470JL-3	—	—	57.4	65.2	—	32	—
—	53.6	—	70.18	1.984	—	1.1	—	0.8	15.9	89.3	6 800	—	TPK5470JL-4	—	—	57.4	65.2	—	36	—
55	55	78	78	3	1	—	4	—	32.4	171	5 200	TP5578	—	W5578F WS5578F	60.4	74	33	—	19	75
55.48	56.8	—	69.6	1.984	—	0.8	—	—	15.9	89.3	6 800	—	TPK5570J	—	—	57.4	65.2	—	20	—
—	55.9	—	76	1.984	—	0.8	—	0.8	16.2	91.9	6 500	—	TVK5676JL	—	—	60.6	69.8	—	40	—
—	55.9	—	76.6	1.984	—	1.1	—	0.8	16.2	91.9	6 500	—	TVK5677JL	—	—	60.6	69.8	—	41	—
—	57	70.8	71	1.984	—	—	—	0.8	14.6	80.7	6 700	—	TVK5771L	—	—	61.8	69.8	—	20	—
60	60	85	85	3	1	—	5	—	38.3	218	5 000	TP6085	—	W6085F WS6085F	81	65.4	40	—	22	112
—	60.4	—	78	2	—	0.8	—	0.8	17.9	107	6 400	—	TPK6078JL	—	—	65.6	73.6	—	38	—
62	—	80.25	—	2	—	—	—	—	23.3	151	6 300	TP6280A	—	—	65.2	76.8	20	—	—	—
—	63	77.73	78	2	—	—	—	0.8	13.6	75.5	6 400	—	TVK6378L	—	—	68	76	—	23	—
65	65	90	90	3	1	—	5	—	40.1	236	4 900	TP6590	—	W6590F WS6590F	86	70.4	43	—	24	119
70	70	95	95	4	1	—	3	—	52.1	275	4 100	TP7095	—	W7095F WS7095F	74.2	90.2	70	—	25	75
70.03	—	92.37	—	3.175	—	—	—	—	33.4	181	4 700	TV7092A	—	—	75	87.4	34	—	—	—

Needle roller thrust bearings

d (d_1) 71.9 ~ 100 mm

Separable type

Non-separable type

Needle roller and cage thrust assembly

Race

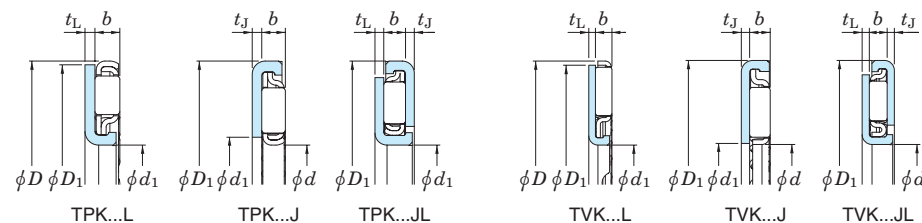
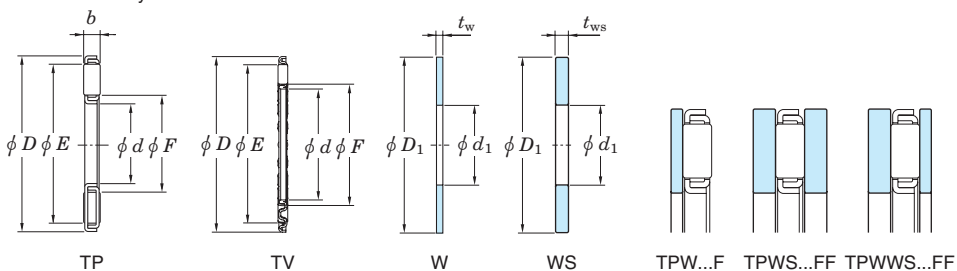

Boundary dimensions (mm)									Basic load ratings (kN)		Limiting speeds (min ⁻¹)	Bearing No.				Dimensions (mm)		(Refer.) Mass (g)			
d	d_1	D	D_1	b	t_w	t_J	t_{ws}	t_L	C_a	C_{0a}	Oil lub.	Needle roller and cage thrust ass'y Separable type	Thin plate race (pressed)	Thick plate race (machined)	E	F	[TP TV]	[TPK TVK]	(W)	(WS)	
—	71.9	85.6	85.5	2	—	0.8	—	—	14.1	82.4	6 100	—	TPK7286L	—	—	76.5	83.1	—	27	—	—
—	73.6	—	89.6	2	—	0.8	—	0.8	10	52.6	6 000	—	TPK7490JL	—	—	78	84.6	—	41	—	—
75	75	100	100	4	2	—	5	—	46.7	243	4 000	TP75100	—	W75100F	WS75100F	95	79.4	63	—	54	135
80	80	105	105	4	1	—	6	—	47.8	255	3 900	TP80105	—	W80105F	WS80105F	100	84.4	67	—	29	171
82.68	—	114.3	—	9.525	—	—	—	—	117	453	2 400	TP83114	—	—	—	88.6	109	218	—	—	—
—	83.1	—	104	2	—	2	—	0.8	14.7	90	5 500	—	TVK83104JL	—	—	88.8	96.8	—	77	—	—
85	85	110	110	4	1	—	6	—	48.9	266	3 800	TP85110	—	W85110F	WS85110F	105	89.4	70	—	30	180
90	90	120	120	4	1	—	6	—	60.9	362	3 600	TP90120	—	W90120F	WS90120F	115	95.4	92	—	39	234
100	100	135	135	4	1	—	6	—	76.3	503	3 400	TP100135	—	W100135F	WS100135F	130	106.4	122	—	51	304

Stud type track rollers (cam followers) CM (full complement type)

D 16 ~ 90 mm

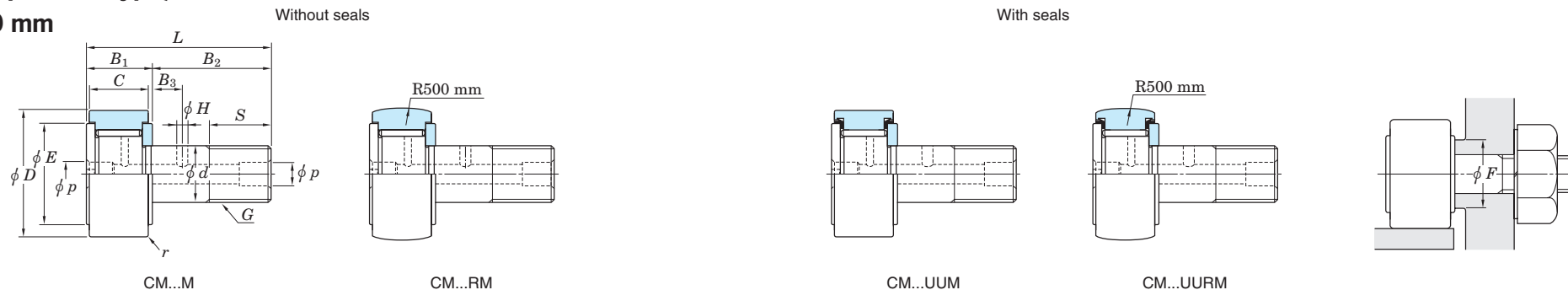

Outer ring D	C	r min.	Boundary dimensions (mm)							Lubrication hole p	Bearing No. Without seals		With seals		Clamping dia. F (mm)	Track roller load ratings ²⁾		JIS Basic load ratings ³⁾		Track capacity ⁴⁾ (kN)	Limiting speeds ⁵⁾ (min ⁻¹)		Tightening torque ⁶⁾ (N·m) max.	(Refer.) Mass (CM...M type) (kg)		
			d	L	B ₁	B ₂	E	G	S		Cylindrical outer ring	Crowned outer ring	Cylindrical outer ring	Crowned outer ring		C _t (kN)	P _{max} (kN)	C _r (kN)	C _{0r} (kN)		Grease lub.	Oil lub.				
16	11	0.3	6	28	12	16	12	M6×1	9	—	—	4 ¹⁾	CM6M	CM6RM	CM6UUM	CM6UURM	10.5	5.85	2.25	7.00	8.25	3.55	9 200	13 000	3.0	0.019
19	11	0.3	8	32	12	20	15	M8×1.25	11	—	—	4 ¹⁾	CM8M	CM8RM	CM8UUM	CM8UURM	12.5	6.70	5.20	8.05	10.4	4.25	8 200	12 000	7.3	0.029
22	12	0.5	10	36	13	23	17	M10×1.25	13	—	—	4	CM10M	CM10RM	CM10UUM	CM10UURM	15	7.80	9.30	9.35	12.3	5.20	7 200	10 000	15	0.044
26	12	0.5	10	36	13	23	17	M10×1.25	13	—	—	4	CM10-1M	CM10-1RM	CM10-1UUM	CM10-1UURM	15	7.80	9.30	9.35	12.3	6.15	7 200	10 000	15	0.056
30	14	1	12	40	15	25	22	M12×1.5	14	6	3	6	CM12M	CM12RM	CM12UUM	CM12UURM	19	11.0	13.9	13.2	18.0	7.75	5 900	8 300	26	0.089
32	14	1	12	40	15	25	22	M12×1.5	14	6	3	6	CM12-1M	CM12-1RM	CM12-1UUM	CM12-1UURM	19	11.0	13.9	13.2	18.0	8.25	5 900	8 300	26	0.099
35	18	1	16	52	19.5	32.5	27	M16×1.5	18	8	3	6	CM16M	CM16RM	CM16UUM	CM16UURM	24	16.8	25.7	20.2	33.9	12.0	4 600	6 400	64	0.171
40	20	1.5	18	58	21.5	36.5	32	M18×1.5	20	8	3	6	CM18M	CM18RM	CM18UUM	CM18UURM	27	19.2	31.9	23.1	38.2	14.6	4 000	5 700	92	0.248
47	24	1.5	20	66	25.5	40.5	36	M20×1.5	22	9	4	8	CM20M	CM20RM	CM20UUM	CM20UURM	30.5	25.6	39.1	30.7	57.2	21.2	3 600	5 000	130	0.393
52	24	1.5	20	66	25.5	40.5	36	M20×1.5	22	9	4	8	CM20-1M	CM20-1RM	CM20-1UUM	CM20-1UURM	30.5	25.6	39.1	30.7	57.2	23.5	3 600	5 000	130	0.455
62	29	1.5	24	80	30.5	49.5	44	M24×1.5	25	11	4	8	CM24M	CM24RM	CM24UUM	CM24UURM	37.5	38.8	55.7	46.5	92.0	34.6	2 900	4 100	220	0.810
72	29	2	24	80	30.5	49.5	44	M24×1.5	25	11	4	8	CM24-1M	CM24-1RM	CM24-1UUM	CM24-1UURM	37.5	38.8	55.7	46.5	92.0	38.7	2 900	4 100	220	1.05
80	35	2	30	100	37	63	58	M30×1.5	32	15	4	8	CM30M	CM30RM	CM30UUM	CM30UURM	51	64.0	95.2	76.8	159	53.3	2 100	3 000	440	1.64
85	35	2	30	100	37	63	58	M30×1.5	32	15	4	8	CM30-1M	CM30-1RM	CM30-1UUM	CM30-1UURM	51	64.0	95.2	76.8	159	56.6	2 100	3 000	440	1.81
90	35	2	30	100	37	63	58	M30×1.5	32	15	4	8	CM30-2M	CM30-2RM	CM30-2UUM	CM30-2UURM	51	64.0	95.2	76.8	159	60.0	2 100	3 000	440	2.00

[Notes] 1) Stud type track rollers with no lubrication hole on the stud threaded end.
 2) To calculate track roller rated service life, use these track roller load rating (C_t). Numerical values P_{max} refer to maximum load track roller can accommodate. If track roller is fixed in housing as with regular type bearings, JIS basic static load rating values (C_{0r}) may apply.
 3) If track roller is fixed in housing, as with regular type bearings, rated service life can be calculated using JIS basic dynamic load rating values (C_r).
 4) Track capacity is described earlier in this section (p. B 386). The values listed in the table are the capacities of cylindrical track rollers.
 5) Limiting speeds are applicable to without seals type.
 6) Tightening torque apply when threaded portion is dry; if thread is wet with oil or other fluid, torque is half these values.

Stud type track rollers (cam followers) KM (caged type)

D 13 ~ 90 mm

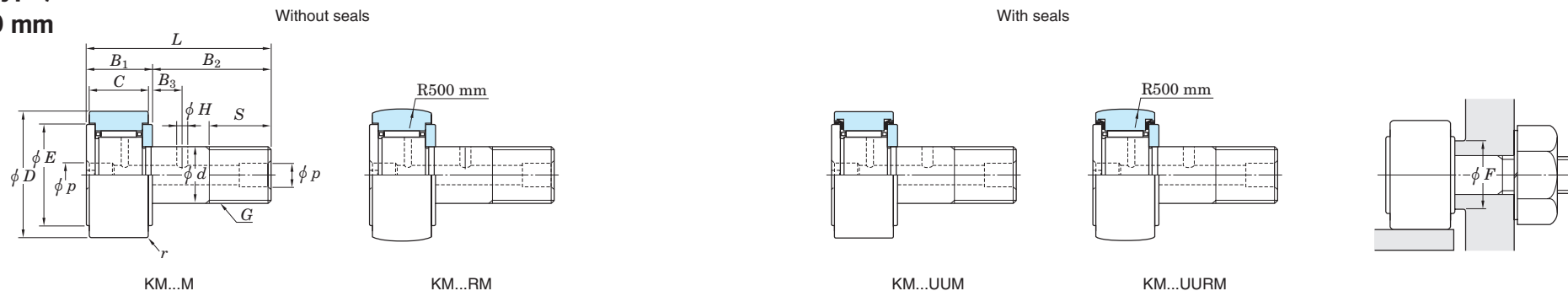

Outer ring D	Boundary dimensions (mm)			Stud									Bearing No. Without seals		With seals		Clamping dia. F (mm)	Track roller load ratings ²⁾		JIS Basic load ratings ³⁾		Track capacity ⁴⁾ (kN)	Limiting speeds ⁵⁾ (min ⁻¹)		Tightening torque ⁶⁾ (N·m) max.	(Refer.) Mass (KM...M type) (kg)
	C	r min.	d	L	B ₁	B ₂	E	G	S	B ₃	H	P	Cylindrical outer ring	Crowned outer ring	Cylindrical outer ring	Crowned outer ring		C _t (kN)	P _{max} (kN)	C _r (kN)	C _{0r} (kN)		Grease lub.	Oil lub.		
13	9	0.3	5	23	10	13	10	M5×0.8	7.5	—	—	3 ¹⁾	KM5M	KM5RM	KM5UUM	KM5UURM	9.0	2.20	1.60	2.65	2.45	2.35	16 000	22 000	1.8	0.010
16	11	0.3	6	28	12	16	12	M6×1	9	—	—	4 ¹⁾	KM6M	KM6RM	KM6UUM	KM6UURM	10.5	3.40	2.25	4.10	4.05	3.55	15 000	20 000	3.0	0.018
19	11	0.3	8	32	12	20	15	M8×1.25	11	—	—	4 ¹⁾	KM8M	KM8RM	KM8UUM	KM8UURM	12.5	3.80	4.10	4.55	4.90	4.25	13 000	18 000	7.3	0.028
22	12	0.5	10	36	13	23	17	M10×1.25	13	—	—	4	KM10M	KM10RM	KM10UUM	KM10UURM	15	5.20	6.05	6.25	7.25	5.20	11 000	16 000	15	0.043
26	12	0.5	10	36	13	23	17	M10×1.25	13	—	—	4	KM10-1M	KM10-1RM	KM10-1UUM	KM10-1UURM	15	5.20	6.05	6.25	7.25	6.15	11 000	16 000	15	0.055
30	14	1	12	40	15	25	22	M12×1.5	14	6	3	6	KM12M	KM12RM	KM12UUM	KM12UURM	19	6.80	8.00	8.20	9.60	7.75	9 500	13 000	26	0.087
32	14	1	12	40	15	25	22	M12×1.5	14	6	3	6	KM12-1M	KM12-1RM	KM12-1UUM	KM12-1UURM	19	6.80	8.00	8.20	9.60	8.25	9 500	13 000	26	0.096
35	18	1	16	52	19.5	32.5	27	M16×1.5	18	8	3	6	KM16M	KM16RM	KM16UUM	KM16UURM	24	10.8	15.8	13.0	18.9	12.0	7 400	10 000	64	0.166
40	20	1.5	18	58	21.5	36.5	32	M18×1.5	20	8	3	6	KM18M	KM18RM	KM18UUM	KM18UURM	27	13.3	19.6	15.9	23.5	14.6	6 500	8 900	92	0.245
47	24	1.5	20	66	25.5	40.5	36	M20×1.5	22	9	4	8	KM20M	KM20RM	KM20UUM	KM20UURM	30.5	17.7	29.5	21.3	35.4	21.2	5 700	7 900	130	0.387
52	24	1.5	20	66	25.5	40.5	36	M20×1.5	22	9	4	8	KM20-1M	KM20-1RM	KM20-1UUM	KM20-1UURM	30.5	17.7	29.5	21.3	35.4	23.5	5 700	7 900	130	0.453
62	29	1.5	24	80	30.5	49.5	44	M24×1.5	25	11	4	8	KM24M	KM24RM	KM24UUM	KM24UURM	37.5	26.3	46.1	31.6	55.3	34.6	4 600	6 400	220	0.801
72	29	2	24	80	30.5	49.5	44	M24×1.5	25	11	4	8	KM24-1M	KM24-1RM	KM24-1UUM	KM24-1UURM	37.5	26.3	46.1	31.6	55.3	38.7	4 600	6 400	220	1.04
80	35	2	30	100	37	63	58	M30×1.5	32	15	4	8	KM30M	KM30RM	KM30UUM	KM30UURM	51	46.5	86.9	55.8	104	53.3	3 400	4 700	440	1.62
85	35	2	30	100	37	63	58	M30×1.5	32	15	4	8	KM30-1M	KM30-1RM	KM30-1UUM	KM30-1UURM	51	46.5	86.9	55.8	104	56.6	3 400	4 700	440	1.79
90	35	2	30	100	37	63	58	M30×1.5	32	15	4	8	KM30-2M	KM30-2RM	KM30-2UUM	KM30-2UURM	51	46.5	86.9	55.8	104	60.0	3 400	4 700	440	1.98

[Notes] 1) Stud type track rollers with no lubrication hole on the stud threaded end.
 2) To calculate track roller rated service life, use these track roller load rating (C_t). Numerical values P_{max} refer to maximum load track roller can accommodate. If track roller is fixed in housing as with regular type bearings, JIS basic static load rating values (C_{0r}) may apply.
 3) If track roller is fixed in housing, as with regular type bearings, rated service life can be calculated using JIS basic dynamic load rating values (C_r).
 4) Track capacity is described earlier in this section (p. B 386). The values listed in the table are the capacities of cylindrical track rollers.
 5) Limiting speeds are applicable to without seals type.
 6) Tightening torque apply when threaded portion is dry; if thread is wet with oil or other fluid, torque is half these values.

Yoke type track rollers (roller followers) CYM (full complement type)

d 5 ~ 50 mm

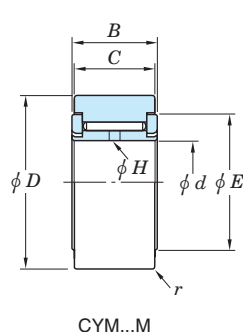

CYM...M

Without seals

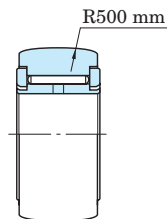

CYM...RM

With seals

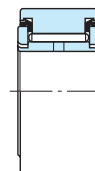

CYM...UUM

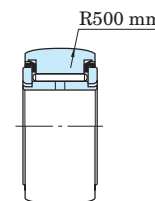

CYM...UURM

d	Boundary dimensions (mm)						Bearing No.				Track roller load ratings ²⁾		JIS Basic load ratings ³⁾		Track capacity ⁴⁾	Limiting speeds ⁵⁾ (min ⁻¹)		(Refer.) Mass (CYM...M type) (kg)
	D	B	C	$r_{min.}$	E	H^1	Without seals Cylindrical outer ring	Without seals Crowned outer ring	With seals Cylindrical outer ring	With seals Crowned outer ring	C_t (kN)	P_{max} (kN)	C_r (kN)	C_{or} (kN)	(kN)	Grease lub.	Oil lub.	
5	16	12	11	0.3	12	2	CYM5M	CYM5RM	CYM5UUM	CYM5UURM	5.85	6.85	7.00	8.25	3.55	9 200	13 000	0.014
6	19	12	11	0.3	15	2	CYM6M	CYM6RM	CYM6UUM	CYM6UURM	6.70	8.70	8.05	10.4	4.25	8 200	12 000	0.021
8	24	15	14	0.5	18	2	CYM8M	CYM8RM	CYM8UUM	CYM8UURM	9.55	12.6	11.5	15.1	6.70	6 800	9 500	0.043
10	30	15	14	1	22	2	CYM10M	CYM10RM	CYM10UUM	CYM10UURM	11.1	15.1	13.3	18.1	7.75	5 900	8 300	0.062
12	32	15	14	1	24	2	CYM12M	CYM12RM	CYM12UUM	CYM12UURM	11.9	17.3	14.3	20.7	8.25	5 300	7 400	0.069
15	35	19	18	1	27	2	CYM15M	CYM15RM	CYM15UUM	CYM15UURM	16.8	28.2	20.2	33.9	12.0	4 600	6 400	0.105
17	40	21	20	1.5	32	2.4	CYM17M	CYM17RM	CYM17UUM	CYM17UURM	19.2	31.8	23.1	38.2	14.6	4 000	5 700	0.153
20	47	25	24	1.5	36	2.4	CYM20M	CYM20RM	CYM20UUM	CYM20UURM	25.6	47.7	30.7	57.3	21.2	3 600	5 000	0.255
25	52	25	24	1.5	41	2.4	CYM25M	CYM25RM	CYM25UUM	CYM25UURM	28.4	58.2	34.1	69.8	23.5	3 000	4 200	0.284
30	62	29	28	1.5	51	3.2	CYM30M	CYM30RM	CYM30UUM	CYM30UURM	41.5	88.8	49.8	107	33.3	2 400	3 400	0.476
35	72	29	28	2	58	3.2	CYM35M	CYM35RM	CYM35UUM	CYM35UURM	47.4	99.4	56.9	119	37.1	2 100	2 900	0.649
40	80	32	30	2	63	3.2	CYM40M	CYM40RM	CYM40UUM	CYM40UURM	58.3	122	70.0	147	44.7	1 900	2 600	0.845
45	85	32	30	2	69	3.2	CYM45M	CYM45RM	CYM45UUM	CYM45UURM	61.4	135	73.7	162	47.5	1 700	2 400	0.924
50	90	32	30	2	75	3.2	CYM50M	CYM50RM	CYM50UUM	CYM50UURM	64.2	148	77.0	177	50.3	1 600	2 200	0.984

[Notes] 1) Lubrication hole is provided on inner ring internal surface.

2) To calculate track roller rated service life, use these track roller load rating values (C_t). Numerical values P_{max} refer to maximum load track roller can accommodate. If track roller is fixed in housing as with regular type bearings, JIS basic static load rating values (C_{or}) may apply.

3) If track roller is fixed in housing, as with regular type bearings, rated service life can be calculated using JIS basic dynamic load rating values (C_r).

4) Track capacity is described earlier in this section (p. B 386).

The values listed in the above table are the capacities of cylindrical track rollers. The track capacities of crowned track rollers are 80 % of these values.

5) Limiting speeds are as measured with no seals.

Yoke type track rollers (roller followers) CXM (caged type)

d 5 ~ 50 mm



Boundary dimensions (mm)							Bearing No.				Track roller load ratings ²⁾		JIS Basic load ratings ³⁾		Track capacity ⁴⁾	Limiting speeds ⁵⁾ (min ⁻¹)		(Refer.) Mass (CXM...M type) (kg)
d	D	B	C	$r_{min.}$	E	H^1	Without seals		With seals		C_t (kN)	P_{max} (kN)	C_r (kN)	C_{or} (kN)	(kN)	Grease lub.	Oil lub.	
							Cylindrical outer ring	Crowned outer ring	Cylindrical outer ring	Crowned outer ring								
5	16	12	11	0.3	12	2	CXM5M	CXM5RM	CXM5UUM	CXM5UURM	3.40	3.40	4.10	4.05	3.55	15 000	20 000	0.011
6	19	12	11	0.3	15	2	CXM6M	CXM6RM	CXM6UUM	CXM6UURM	3.80	4.10	4.55	4.90	4.25	13 000	18 000	0.018
8	24	15	14	0.5	18	2	CXM8M	CXM8RM	CXM8UUM	CXM8UURM	5.70	6.40	6.85	7.65	6.70	11 000	15 000	0.040
10	30	15	14	1	22	2	CXM10M	CXM10RM	CXM10UUM	CXM10UURM	6.80	8.00	8.20	9.60	7.75	9 500	13 000	0.060
12	32	15	14	1	24	2	CXM12M	CXM12RM	CXM12UUM	CXM12UURM	7.25	9.05	8.70	10.8	8.25	8 400	12 000	0.067
15	35	19	18	1	27	2	CXM15M	CXM15RM	CXM15UUM	CXM15UURM	10.8	15.8	13.0	18.9	12.0	7 400	10 000	0.102
17	40	21	20	1.5	32	2.4	CXM17M	CXM17RM	CXM17UUM	CXM17UURM	13.3	19.6	15.9	23.5	14.6	6 500	8 900	0.150
20	47	25	24	1.5	36	2.4	CXM20M	CXM20RM	CXM20UUM	CXM20UURM	17.7	29.5	21.3	35.4	21.2	5 700	7 900	0.252
25	52	25	24	1.5	41	2.4	CXM25M	CXM25RM	CXM25UUM	CXM25UURM	19.2	34.6	23.0	41.5	23.5	4 800	6 600	0.278
30	62	29	28	1.5	51	3.2	CXM30M	CXM30RM	CXM30UUM	CXM30UURM	28.4	53.9	34.0	64.7	33.3	3 900	5 300	0.465
35	72	29	28	2	58	3.2	CXM35M	CXM35RM	CXM35UUM	CXM35UURM	32.4	60.3	38.9	72.4	37.1	3 300	4 600	0.636
40	80	32	30	2	63	3.2	CXM40M	CXM40RM	CXM40UUM	CXM40UURM	41.4	78.1	49.7	93.7	44.7	3 000	4 100	0.825
45	85	32	30	2	69	3.2	CXM45M	CXM45RM	CXM45UUM	CXM45UURM	42.7	83.6	51.2	100	47.5	2 700	3 700	0.901
50	90	32	30	2	75	3.2	CXM50M	CXM50RM	CXM50UUM	CXM50UURM	45.5	93.9	54.6	113	50.3	2 500	3 400	0.960

[Notes] 1) Lubrication hole is provided on inner ring internal surface.
 2) To calculate track roller rated service life, use these track roller load rating values (C_t). Numerical values P_{max} refer to maximum load track roller can accommodate. If track roller is fixed in housing as with regular type bearings, JIS basic static load rating values (C_{or}) may apply.
 3) If track roller is fixed in housing, as with regular type bearings, rated service life can be calculated using JIS basic dynamic load rating values (C_r).

4) Track capacity is described earlier in this section (p. B 386). The values listed in the above table are the capacities of cylindrical track rollers. The track capacities of crowned track rollers are 80 % of these values.
 5) Limiting speeds are as measured with no seals.

Miniature one-way clutches

Miniature one-way clutches consist of a case carburizing steel drawn cup, metal or synthetic resin spring, synthetic resin cage and needle rollers.

They are used in clutch mechanisms of various machines. Use in office automation equipment such as copying and facsimile machines is especially common.

- Useful for making equipment smaller and lighter, due to a drawn cup made of thin sheet steel.
- Locking protrusions are provided around the drawn cup, so that creeping can be prevented without having to hold the surface dimensional accuracy precisely.
- Pre-lubricated with optimum grease, so that no lubrication is necessary under normal operating conditions.
- Unit products with a synthetic resin housing are also available.

They are compatible with components of various types, such as gears, timing pulleys, cams and rubber rollers. Consult with JTEKT for further information. Refer to JTEKT catalog "miniature one-way clutch".



1WC series



EWC series



Various housings and unit products

Structure and principles

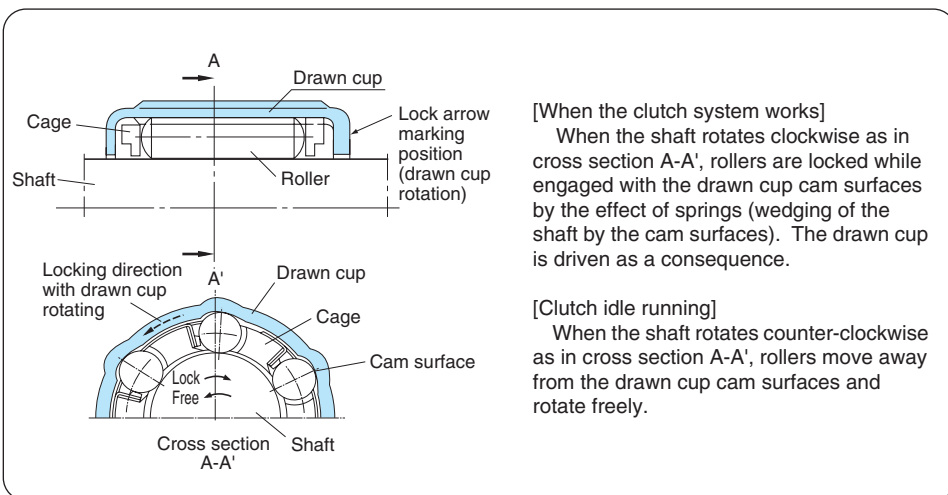

Miniature one-way clutch types and characteristics

	1WC series (with metal springs)		EWC series (with synthetic resin springs)	
	Heavy load type		Heavy load type	Light load type
	1WC...		EWC...C	EWC...A
Torque capacity	Heavy load		Heavy load	Light load
Operating temperature range	- 10 to + 90°C		- 10 to + 70°C	
Locking life	Locking system can function more than one million. (Note : this estimation is valid as long as torque magnitude does not exceed the torque capacity shown in the specification table.)			
Insert molding	Possible		Impossible	
Delivery of clutch only	Possible			
Unit delivery	Possible			

Shaft tolerance

	Heavy load type (1WC... , EWC...C)	Light load type (EWC...A)
Shaft tolerance class	h 8	
Surface hardness	50 HRC or harder	30 HRC or harder
Roughness (Ra)	0.3 a or less	0.8 a or less
Roundness and cylindricity	0.005 mm or less	

[Remarks] In some operating conditions, shafts need not be as accurate as shown here.

For example :

1. When clutch engaging accuracy is considered unimportant, or when a radial load or moment is not generated, the shaft diameter tolerance can be :
 - shaft diameter 6 mm or less, and EWC0809 (C, A) : 0 to - 0.040 mm
 - shaft diameter 8 mm or more : h 10
2. When the loaded torque is smaller than the torque capacity, shaft surface hardness can be determined as follows :

* The diagram on the right shows approximate shaft surface hardness relative to torque ratio A.

$$\text{Torque ratio (A)} = \frac{\text{Loaded torque}}{\text{Heavy load type torque capacity}}$$

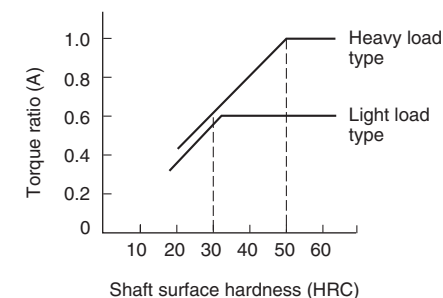

Miniature one-way clutches

d 4 ~ 12 mm

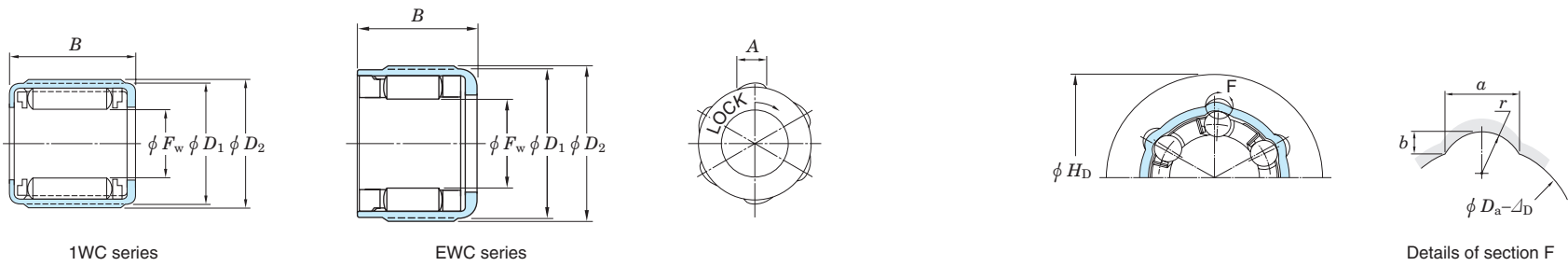

Shaft dia. (mm)	Boundary dimensions (mm)					Torque capacity (N·m)	Designations		No. of ¹⁾ outer ring protrusion	Recommended housing dimensions (mm)						(Refer.) Mass (g)		
	<i>F_w</i>	<i>D</i> ₁	<i>D</i> ₂	<i>B</i>	<i>A</i>		1WC series (With metal springs)	EWC series (With resin spring)		<i>H</i> _D	<i>a</i>	<i>b</i>	<i>r</i>	<i>D</i> _a	∠ <i>D</i> _D ²⁾	1WC	EWC	
4	4	8	8.4	6	2.6	0.08	—	EWC0406A	4	12	2.65	0.50	2	8	0.06	—	1.0	
	4	8	8.4	6	2.6	0.15	—	EWC0406C	4	12	2.65	0.50	2	8	0.06	—	1.0	
6	6	10	10.4	8	2.8	0.25	—	EWC0608A	6	14	2.8	0.57	2	10	0.08	—	1.7	
	6	10	10.4	8	2.8	0.44	—	EWC0608C	6	14	2.8	0.57	2	10	0.08	—	1.7	
	6	10	10.4	8	2.8	0.44	1WC0608	—	6	14	2.8	0.57	2	10	0.08	2.0	—	
	6	10	10.4	12	2.8	0.88	1WC0612	—	6	14	2.8	0.57	2	10	0.08	3.0	—	
8	8	12	12.4	9	2.6	0.49	—	EWC0809A	6	16	2.6	0.48	2	12	0.10	—	2.4	
	8	12	12.4	9	2.6	0.88	—	EWC0809C	6	16	2.6	0.48	2	12	0.10	—	2.4	
	8	14.2	15	12	3.6	1.18	—	EWC0812A	6	18.5	3.6	0.87	2.3	14.2	0.11	—	5.8	
	8	14.2	15	12	3.6	1.96	—	EWC0812C	6	18.5	3.6	0.87	2.3	14.2	0.11	—	5.8	
	8	14.2	15	12	3.6	1.96	1WC0812	—	6	18.5	3.6	0.87	2.3	14.2	0.11	7.0	—	
	8	14.2	15	14.5	3.6	2.65	1WC0815	—	6	18.5	3.6	0.87	2.3	14.2	0.11	8.0	—	
	10	10	16	17	10	5	1.18	—	EWC1010A	6	21	5.0	1.20	3.2	16	0.13	—	6.0
		10	16	17	10	5	1.96	—	EWC1010C	6	21	5.0	1.20	3.2	16	0.13	—	6.0
10		16	17	12	5	1.37	—	EWC1012A	6	21	5.0	1.20	3.2	16	0.13	—	6.8	
10		16	17	12	5	2.35	—	EWC1012C	6	21	5.0	1.20	3.2	16	0.13	—	6.8	
10		16	17	12	5	2.35	1WC1012	—	6	21	5.0	1.20	3.2	16	0.13	8.0	—	
10		16	17	12	5	2.35	1WC1012	—	6	21	5.0	1.20	3.2	16	0.13	8.0	—	
12	12	18	19	16	5.1	6.28	1WC1216	—	8	23	5.1	1.20	3.3	18	0.14	12	—	

[Notes] 1) Provided at equal intervals.
2) Recommended interference when polyacetal resin housing is used.

Ball bearing units

Ball bearing units consist of pre-lubricated sealed ball bearings and a housing which varies in shape.

They are capable of aligning themselves efficiently using the spherical fitting surface between the bearing and housing, effectively preventing overloads due to misalignment.

Koyo ball bearing units are highly accurate and feature excellent load resistance. They are completely sealed, and provided with a relubrication feature.

Ball bearing units without a relubrication feature are also available.

For details, refer to JTEKT separate catalog "Ball bearing units" (CAT. NO. B2007E).



Pillow block type



Bore diameter 12 – 140 mm

Flanged type

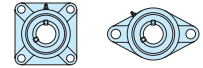

Bore diameter 12 – 140 mm

Flanged type with spigot joint



Bore diameter 12 – 140 mm

Take-up type



Bore diameter 12 – 140 mm

Cartridge type



Bore diameter 12 – 140 mm

Light duty units



Bore diameter 12 – 40 mm

"Compact" series (made from light alloy)



Bore diameter 10 – 30 mm

Stainless-series



Bore diameter 12 – 50 mm

Pressed steel units

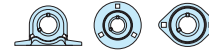

Bore diameter 12 – 35 mm







Ball bearings for units







Bore diameter 10 – 140 mm

Typical types of ball bearing unit



(1) Cast iron units

	<p>Pillow block type</p> <ul style="list-style-type: none"> ● UCP 2·X·3 ▲ UKP 2·X·3 ■ NAP 2
	<p>Square-flanged type</p> <ul style="list-style-type: none"> ● UCF 2·X·3 ▲ UKF 2·X·3 ■ NANF 2
	<p>Square-flanged type with spigot joint</p> <ul style="list-style-type: none"> ● UCFS 3 ▲ UKFS 3
	<p>Rhombic-flanged type</p> <ul style="list-style-type: none"> ● UCFL 2·X·3 ▲ UKFL 2·X·3 ■ NANFL 2
	<p>Round-flanged type with spigot joint</p> <ul style="list-style-type: none"> ● UCFC 2·X ▲ UKFC 2·X ■ NAFC 2
	<p>Take-up type</p> <ul style="list-style-type: none"> ● UCT 2·X·3 ▲ UKT 2·X·3 ■ NAT 2
	<p>Cartridge type</p> <ul style="list-style-type: none"> ● UCC 2·X·3 ▲ UKC 2·X·3 ■ NAC 2

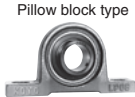

Special pillow block types Thick section pillow block type

	
● UCPH 2 ● UCPA 2	● UCIP 2·3 ▲ UKIP 2·3
	
● UCFA 2 ● UCFB 2	● UCHA 2



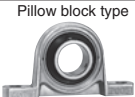

(2) Light duty units (cast iron)

	
■ BLP 2	■ BLF 2

(3) "Compact" series units (special light alloy)

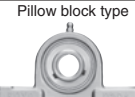
	
● UP 0	● UFL 0



(4) Stainless-series units (stainless steel)

	
● UCSP 2...H1S6	● UCSFL 2...H1S6
	
● USP 0...S6	● USFL 0...S6





(5) Pressed steel units

		
● SBPP2	● SBPFL2	● SBPF2

(6) Take-up units with frame

	
● UCTH 2 { ● SBNPTH 2 } ● SBPTH 2	● UCTL 2 ● UCTU 2 ● UCTU 3

(7) Ball bearings for units

	<p>Cylindrical bore type (with set screws)</p> <ul style="list-style-type: none"> ● UC 2·X·3 ● SB 2 ● SU 0 		<p>Cylindrical bore type (with set screws)</p> <ul style="list-style-type: none"> ● RB 2 <p>(Sealed deep groove ball bearings having an extended inner ring.)</p>
	<p>Tapered bore type (with adapter)</p> <ul style="list-style-type: none"> ▲ UK 2·X·3 		<p>Cylindrical bore type (with set screws)</p> <ul style="list-style-type: none"> ● ER 2 <p>(Sealed deep groove ball bearings having an extended inner ring and an outer ring provided with a locating snap ring, lubrication groove and lubrication holes.)</p>
	<p>Cylindrical bore type (with eccentric locking collar)</p> <ul style="list-style-type: none"> ■ NA 2 		

[Note] This catalog includes the specifications of major units and bearings which are boxed in the table. For further details, refer to a separate catalog. Marks ●, ▲ and ■ indicate, respectively, that the unit or bearing is fixed with a set screw, adapter, or eccentric locking collar.

Tolerances	<ul style="list-style-type: none"> · Ball bearings as specified in JIS B 1558 (Tables 1 and 2). (refer to Table 7-11, class 0 on p. A 70 for the tapered bore tolerance.) · Housings.....as specified in JIS B 1559. <p>(the internal spherical diameter tolerance is given in Table 3. For other tolerances, refer to a separate catalog.)</p>
Bearing radial internal clearance	<p>As specified in JIS B 1520 (Table 10-2 on p. A 96). JTEKT provides cylindrical bore bearings with standard radial internal clearance. Tapered bore bearings are provided with a C 3 radial internal clearance in consideration of possible inner ring expansion caused by tightening of an adapter.</p>
Recommended fits of inner ring and shaft (indicated by the tolerance class)	<ul style="list-style-type: none"> · Cylindrical bore bearings.....h 6, h 7, h 8, j 6 (k 6, k 7 and m 6 when heavy or impact load is to be supported.) · Tapered bore bearings.....h 8, h 9 · High-speed blower bearings (S5)...h 5, j 5
Rotational speed limits	See Table 4.
Allowable aligning angle	<ul style="list-style-type: none"> · 0.052 rad (3°) · For units with a cover, it is best if the misalignment is 0.017 rad (1°) or less to prevent the rubber seal lip on the cover and the shaft contact from distorting the seal lip.

Table 1 Cylindrical bore bearings for units : inner ring tolerance Unit : μm

Nominal bore diameter d (mm)		UC, SA, NA, SU, SB, RB and ER types		Bearings for blower (S5)				Single inner (outer) ring width deviation $\Delta_{Bs} (\Delta_{Cs})$		Radial runout of assembled bearing inner ring K_{ia}		
		Single plane mean bore diameter deviation Δ_{dmp}		Single plane bore diameter variation V_{dsp}		Single plane mean bore diameter deviation Δ_{dmp}					Single plane bore diameter variation V_{dsp}	
		upper	lower	max.	upper	lower	max.				upper	lower
over	up to	upper	lower	max.	upper	lower	max.	upper	lower	max.		
10 more	18	+15	0	10	+13	0	6	0	-120	15		
	18	+18	0	12	+13	0	6	0	-120	18		
	31.75	+21	0	14	+13	0	10	0	-120	20		
	50.8	+24	0	16	+15	0	10	0	-150	25		
	80	+28	0	19	+18	0	14	0	-200	30		
	120	+33	0	22	+23	0	14	0	-250	35		

Table 2 Ball bearings for units : outer ring tolerance Unit : μm

Nominal outside diameter D (mm)		Mean outside diameter deviation Δ_{Dm}		Radial runout of assembled bearing outer ring K_{ea}
		upper	lower	
over	up to	upper	lower	max.
30	50	0	-11	20
50	80	0	-13	25
80	120	0	-15	35
120	150	0	-18	40
150	180	0	-25	45
180	250	0	-30	50
250	315	0	-35	60

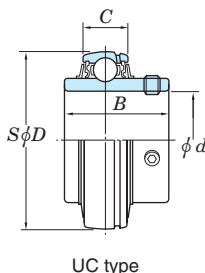

[Note] The lower value of mean outside diameter deviation does not apply to the sides of outer rings up to the extent of a quarter of the outer ring width from the side faces.

Table 3 Housing bore internal spherical diameter tolerance Unit : μm

Nominal spherical bore diameter D_a (mm)		Tolerance class H		Tolerance class J		Tolerance class K	
		Deviation of spherical bearing seat dia. Δ_{Dam}		Deviation of spherical bearing seat dia. Δ_{Dam}		Deviation of spherical bearing seat dia. Δ_{Dam}	
		upper	lower	upper	lower	upper	lower
over	up to	upper	lower	upper	lower	upper	lower
30	50	+25	0	+14	-11	+7	-18
50	80	+30	0	+18	-12	+9	-21
80	120	+35	0	+22	-13	+10	-25
120	180	+40	0	+26	-14	+12	-28
180	250	+46	0	+30	-16	+13	-33
250	315	+52	0	+36	-16	+16	-36

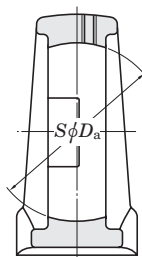

[Remark] JTEKT generally applies class J to housing designs. Class H and class K can also be applied depending on the application.

Table 4 Limiting speed of ball bearing units Unit : min^{-1}

Bore diameter No.	Standard Cold resistant type (D2K2)			Triple-lip sealed (L3)			For high speed rotation (K3 and S5)			Heat resistant type (D1K2)
	Diameter series			Diameter series			Diameter series			Diameter series
	2	X	3	2	X	3	2	X	3	2, X, 3
01	5 800			2 300			8 700			3 800
02	5 800			2 300			8 700			3 800
03	5 800			2 300			8 700			3 800
04	5 800	-	-	2 300	-	-	8 700	-	-	3 800
05	5 100	4 300	4 600	2 100	960		7 700	6 400	6 700	3 000
06	4 300	3 700	3 900	960	830	-	6 400	5 500	5 800	2 500
07	3 700	3 300	3 400	830	750	770	5 500	5 000	5 100	2 100
08	3 300	3 100	3 100	750	690	690	5 000	4 600	4 600	1 900
09	3 100	2 800	2 700	690	640	620	4 600	4 300	4 100	1 700
10	2 800	2 500	2 400	640	570	550	4 300	3 800	3 700	1 500
11	2 500	2 300	2 300	570	520	510	3 800	3 500	3 400	1 400
12	2 300	2 200	2 100	520	490	470	3 500	3 200	3 100	1 300
13	2 200	2 100	1 900	490	460	440	3 200	3 100	2 900	1 200
14	2 100	2 000	1 800	460	440	410	3 100	2 900	2 700	1 100
15	2 000	1 800	1 700	440	410	380	2 900	2 700	2 600	1 000
16	1 800	1 700	1 600	410	380	360	2 700	2 600	2 400	940
17	1 700	1 600	1 500	380	360	340	2 600	2 400	2 300	880
18	1 600	1 500	1 400	360	340	320	2 400	2 300	2 100	830
19		-	1 400		-	310		-	2 000	790
20		1 300	1 300		300	280		2 000	1 900	750
21		-	1 200		-	270		-	1 800	710
22			1 100			250			1 700	680
24			1 100			240			1 600	630
26			1 000			220			1 500	580
28			910			200			1 400	540

[Remarks] 1. The rotational speed limits of units with a cover are 80 % of the values given in the table above.
2. When bearings are fit loosely, rotational speed limits should be compensated for by the fitting coefficient given below.

Bearing type	Fitting coefficient					
	Shaft tolerance class					
	h5, j5	j6	h6	h7	h8	h9
Standard	-	1.0	1.0	0.8	0.5	0.2
Triple-lip sealed (L3)	-	-	-	1.0	1.0	0.9
For high speed rotation (K3)	-	1.0	0.8	0.6	-	-
For blower (S5)	1.0	-	0.8	0.6	-	-
Heat-resistant type B (D1K2)	-	-	-	1.0	1.0	0.7

[Recommended shaft design]

**Table 5 Shaft fits for cylindrical bore bearing
-Clearance fit or transition fit-**

Unit : μm

Shaft diameter (mm)		Tolerance of shaft							
		j6		h6		h7		h8	
over	up to	upper	lower	upper	lower	upper	lower	upper	lower
10	18	+ 8	- 3	0	- 11	0	- 18	0	- 27
18	30	+ 9	- 4	0	- 13	0	- 21	0	- 33
30	50	+ 11	- 5	0	- 16	0	- 25	0	- 39
50	80	+ 12	- 7	0	- 19	0	- 30	0	- 46
80	120	+ 13	- 9	0	- 22	0	- 35	0	- 54
120	180	+ 14	- 11	0	- 25	0	- 40	0	- 63
Operating speed $dn^{1)}$		120 000 over		100 000 over 120 000 up to		60 000 over 100 000 up to		60 000 up to	

[Note] 1) $dn = d$ (Bearing bore, mm) \times n (Rotating speed, min^{-1})

**Table 6 Shaft fits for cylindrical bore bearing
-Transition fit or Interference fit-**

Unit : μm

Shaft diameter (mm)		Tolerance of shaft					
		k6		k7		m6	
over	up to	upper	lower	upper	lower	upper	lower
10	18	+12	+1	+19	+1	+18	+7
18	30	+15	+2	+23	+2	+21	+8
30	50	+18	+2	+27	+2	+25	+9
50	80	+21	+2	+32	+2	+30	+11
80	120	+25	+3	+38	+3	+35	+13
120	180	+28	+3	+43	+3	+40	+15

Table 7 Shaft fits for bearings for blower

Unit : μm

Shaft diameter (mm)		Tolerance of shaft			
		h5		j5	
over	up to	upper	lower	upper	lower
10	18	0	- 8	+5	- 3
18	30	0	- 9	+5	- 4
30	50	0	- 11	+6	- 5
50	80	0	- 13	+6	- 7
80	120	0	- 15	+6	- 9
120	180	0	- 18	+7	- 11

Table 8 Shaft fits for tapered bore bearing

Unit : μm

Shaft diameter (mm)		Tolerance of shaft			
		h8		h9	
over	up to	upper	lower	upper	lower
10	18	0	- 27	0	- 43
18	30	0	- 33	0	- 52
30	50	0	- 39	0	- 62
50	80	0	- 46	0	- 74
80	120	0	- 54	0	- 87
120	180	0	- 63	0	- 100

**Table 9 Recommended tolerances of
shaft used for ball bearing units**

Unit : μm

Shaft diameter (mm)		Deviation from circular and cylindrical forms (max.)
	10	6
10	18	8
18	30	9
30	50	11
50	80	13
80	120	15
120	180	18

Table 10 Shaft shoulder dia. and fillet radius

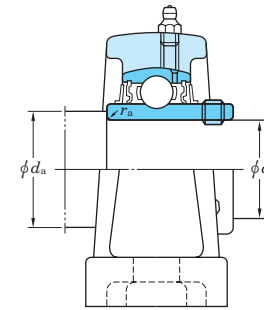

Unit : μm

Bore No.	Nominal bore dia.	UC200, UCX00		UC300	
		d_a	r_a (max.)	d_a	r_a (max.)
01	12	17	0.6		
02	15	20	0.6		
03	17	22	0.6		
04	20	30	1	-	-
05	25	35	1	35	1
06	30	40	1	40	1
07	35	45	1	45	1.5
08	40	50	1	50	1.5
09	45	55	1	55	1.5
10	50	60	1	60	2
11	55	65	1.5	65	2
12	60	70	1.5	75	2
13	65	75	1.5	80	2
14	70	80	1.5	85	2
15	75	85	1.5	90	2
16	80	90	2	95	2
17	85	95	2	100	2.5
18	90	100	2	105	2.5
19	95	-	-	110	2.5
20	100	115	2	115	2.5
21	105	-	-	120	2.5
22	110			125	2.5
24	120			135	2.5
26	130			150	3
28	140			160	3

Ball bearing units
pillow block type
UCP (with set screws)
d 12 ~ (55) mm

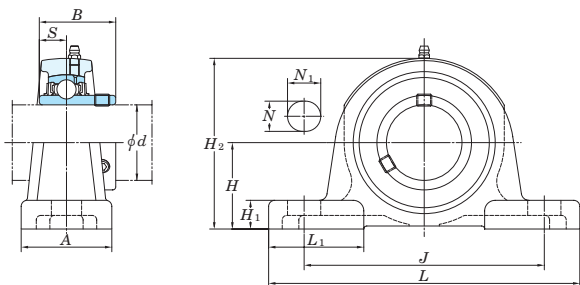

Pressed steel covers

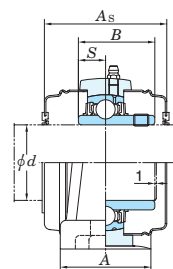

Cast iron covers

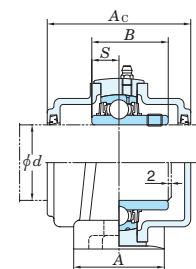

Tolerance for housing

unit : mm

housing No.			ΔH_s
P203- P210	PX05- PX10	P305- P310	± 0.15
P211- P218	PX11- PX18	P311- P318	± 0.2
	PX20	P319- P328	± 0.3

ΔH_s : deviation of distance from mounting base to centre of spherical bearing seating.

P204JE3, P205JE3 (with cast iron covers) are shown below.



Shaft dia. (mm) <i>d</i>	Dimensions (mm)											Bolt size	Unit No.	Housing No.	Applicable bearing			Unit No. with covers				Cover dimensions (mm) <i>A_s</i> <i>A_c</i>	(Refer.) Unit mass (kg)				
	<i>H</i>	<i>L</i>	<i>A</i>	<i>J</i>	<i>N</i>	<i>N₁</i>	<i>H₁</i>	<i>H₂</i>	<i>L₁</i>	<i>B</i>	<i>S</i>				No.	Basic load ratings (kN)		Factor	Pressed steel covers		Cast iron covers		Pressed steel covers	Cast iron covers			
	<i>C_r</i>	<i>C_{0r}</i>	<i>f₀</i>	Open ends	Closed end	Open ends	Closed end																				
12	30.2	127	38	95	13	18	12	60	38	31	12.7	M10	UCP201	P203	UC201	12.8	6.65	13.2	UCP201C	UCP201CD	—	—	44	—	0.63	—	
	15	30.2	127	38	95	13	18	12	60	38	31	12.7	M10	UCP202	P203	UC202	12.8	6.65	13.2	UCP202C	UCP202CD	—	—	44	—	0.61	—
		17	30.2	127	38	95	13	18	12	60	38	31	12.7	M10	UCP203	P203	UC203	12.8	6.65	13.2	UCP203C	UCP203CD	—	—	44	—	0.60
20	33.3	127	38	95	13	18	13	64	38	31	12.7	M10	UCP204	P204	UC204	12.8	6.65	13.2	UCP204C	UCP204CD	UCP204FC	UCP204FCD	44	62	0.66	0.96	
	25	36.5	140	38	105	13	18	13	71	43	34.1	14.3	M10	UCP205	P205	UC205	14.0	7.85	13.9	UCP205C	UCP205CD	UCP205FC	UCP205FCD	48	66	0.80	1.2
		44.4	159	51	119	17	25	16	86	47	38.1	15.9	M14	UCPX05	PX05	UCX05	19.5	11.3	13.9	UCPX05C	UCPX05CD	—	—	52	—	1.5	—
45	175	45	132	17	20	16	85	55	38	15	M14	UCP305	P305	UC305	21.2	10.9	12.6	—	—	UCP305C	UCP305CD	—	76	1.7	2.3		
30	42.9	165	48	121	17	21	15	84	53	38.1	15.9	M14	UCP206	P206	UC206	19.5	11.3	13.9	UCP206C	UCP206CD	UCP206FC	UCP206FCD	52	70	1.3	1.8	
	47.6	175	57	127	17	25	17	93	55	42.9	17.5	M14	UCPX06	PX06	UCX06	25.7	15.4	13.9	UCPX06C	UCPX06CD	—	—	59	—	2.1	—	
	50	180	50	140	17	20	17	95	53	43	17	M14	UCP306	P306	UC306	26.7	15.0	13.3	—	—	UCP306C	UCP306CD	—	82	2.2	2.8	
35	47.6	167	48	127	17	21	16	93	51	42.9	17.5	M14	UCP207	P207	UC207	25.7	15.4	13.9	UCP207C	UCP207CD	UCP207FC	UCP207FCD	59	78	1.6	2.3	
	54	203	57	144	17	30	19	105	64	49.2	19	M14	UCPX07	PX07	UCX07	29.1	17.8	14.0	UCPX07C	UCPX07CD	—	—	68	—	2.7	—	
	56	210	56	160	17	25	19	107	65	48	19	M14	UCP307	P307	UC307	33.4	19.3	13.2	—	—	UCP307C	UCP307CD	—	88	3.0	3.8	
40	49.2	184	54	137	17	21	17	98	57	49.2	19	M14	UCP208	P208	UC208	29.1	17.8	14.0	UCP208C	UCP208CD	UCP208FC	UCP208FCD	68	86	2.0	2.8	
	58.7	222	67	156	20	32	21	114	71	49.2	19	M16	UCPX08	PX08	UCX08	32.7	20.3	14.0	UCPX08C	UCPX08CD	—	—	68	—	3.5	—	
	60	220	60	170	17	27	19	118	65	52	19	M14	UCP308	P308	UC308	40.7	24.0	13.2	—	—	UCP308C	UCP308CD	—	96	3.8	4.8	
45	54	190	54	146	17	21	17	106	60	49.2	19	M14	UCP209	P209	UC209	32.7	20.3	14.0	UCP209C	UCP209CD	UCP209FC	UCP209FCD	68	88	2.2	3.0	
	58.7	222	67	156	20	33	21	116	71	51.6	19	M16	UCPX09	PX09	UCX09	35.1	23.3	14.4	UCPX09C	UCPX09CD	—	—	73	—	3.7	—	
	67	245	67	190	20	30	21	132	75	57	22	M16	UCP309	P309	UC309	48.9	29.5	13.3	—	—	UCP309C	UCP309CD	—	102	4.9	6.2	
50	57.2	206	60	159	20	22	19	113	63	51.6	19	M16	UCP210	P210	UC210	35.1	23.3	14.4	UCP210C	UCP210CD	UCP210FC	UCP210FCD	73	97	2.9	3.9	
	63.5	241	73	171	20	36	22	126	76	55.6	22.2	M16	UCPX10	PX10	UCX10	43.4	29.4	14.4	UCPX10C	UCPX10CD	—	—	75	—	4.6	—	
	75	275	75	212	20	35	24	148	88	61	22	M16	UCP310	P310	UC310	62.0	38.3	13.2	—	—	UCP310C	UCP310CD	—	110	6.6	8.2	
55	63.5	219	60	171	20	22	19	125	70	55.6	22.2	M16	UCP211	P211	UC211	43.4	29.4	14.4	UCP211C	UCP211CD	UCP211FC	UCP211FCD	75	99	3.6	4.8	

[Remarks] 1) Applicable sizes of grease nipples are shown below.
A-1/4-28UNF 201~210, X05~X09, 305~308
A-PT 1/8 211~218, X10~X20, 309~328

2) For bearings with double- or triple-lip seals, unit and bearing number are suffixed by L2 or L3.
3) For more detailed information, refer to ball bearing for unit specification tables.

**Ball bearing units
pillow block type
UCP (with set screws)**
d (55) ~ 95 mm

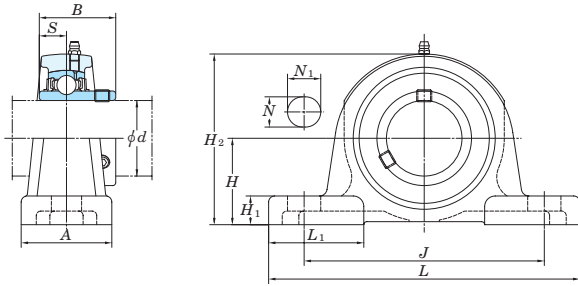

Pressed steel covers

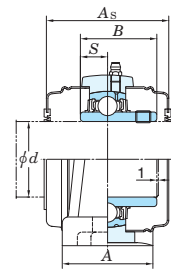

Cast iron covers

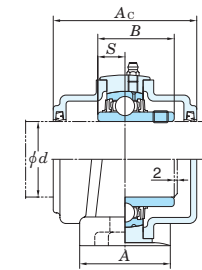

Tolerance for housing

housing No.			unit : mm ΔHs
P203- P210	PX05- PX10	P305- P310	±0.15
P211- P218	PX11- PX18	P311- P318	±0.2
	PX20	P319- P328	±0.3

ΔHs : deviation of distance from mounting base to centre of spherical bearing seating.

Shaft dia. (mm) <i>d</i>	Dimensions (mm)											Bolt size	Unit No.	Housing No.	Applicable bearing			Unit No. with covers				Cover dimensions (mm)		(Refer.) Unit mass (kg)			
	<i>H</i>	<i>L</i>	<i>A</i>	<i>J</i>	<i>N</i>	<i>N</i> ₁	<i>H</i> ₁	<i>H</i> ₂	<i>L</i> ₁	<i>B</i>	<i>S</i>				No.	Basic load ratings (kN)		Factor	Pressed steel covers		Cast iron covers		<i>A</i> _s	<i>A</i> _c	Pressed steel covers	Cast iron covers	
	<i>C_r</i>	<i>C</i> _{0r}	<i>f</i> ₀	Open ends	Closed end	Open ends	Closed end	<i>A</i> _s	<i>A</i> _c	Steel covers	Cast iron covers																
55	69.8	260	79	184	25	36	28	139	83	65.1	25.4	M20	UCPX11	PX11		UCX11	52.4	36.2	14.4	UCPX11C	UCPX11CD	—	—	88	—	6.5	—
	80	310	80	236	20	38	27	158	90	66	25	M16	UCP311	P311		UC311	71.6	45.0	13.2	—	—	UCP311C	UCP311CD	—	114	7.9	9.7
60	69.8	241	70	184	20	25	22	138	76	65.1	25.4	M16	UCP212	P212		UC212	52.4	36.2	14.4	UCP212C	UCP212CD	UCP212FC	UCP212FCD	88	114	4.9	6.4
	76.2	286	83	203	25	40	28	152	88	65.1	25.4	M20	UCPX12	PX12		UCX12	57.2	40.1	14.4	UCPX12C	UCPX12CD	—	—	88	—	7.7	—
	85	330	85	250	25	38	29	167	103	71	26	M20	UCP312	P312		UC312	81.9	52.2	13.2	—	—	UCP312C	UCP312CD	—	124	9.5	11.8
65	76.2	265	70	203	25	30	25	150	78	65.1	25.4	M20	UCP213	P213		UC213	57.2	40.1	14.4	UCP213C	UCP213CD	UCP213FC	UCP213FCD	88	114	5.9	7.6
	76.2	286	83	203	25	40	28	155	88	74.6	30.2	M20	UCPX13	PX13		UCX13	62.2	44.1	14.5	UCPX13C	UCPX13CD	—	—	98	—	8.1	—
	90	340	90	260	25	38	32	176	110	75	30	M20	UCP313	P313		UC313	92.7	59.9	13.2	—	—	UCP313C	UCP313CD	—	122	10.7	12.8
70	79.4	266	72	210	25	30	28	156	78	74.6	30.2	M20	UCP214	P214		UC214	62.2	44.1	14.5	UCP214C	UCP214CD	UCP214FC	UCP214FCD	98	124	6.8	8.7
	88.9	330	89	229	27	50	32	171	98	77.8	33.3	M22	UCPX14	PX14		UCX14	67.4	48.3	14.5	UCPX14C	UCPX14CD	—	—	98	—	10.2	—
	95	360	90	280	27	40	35	186	110	78	33	M22	UCP314	P314		UC314	104	68.2	13.2	—	—	UCP314C	UCP314CD	—	124	12.4	14.7
75	82.6	275	74	217	25	30	28	162	80	77.8	33.3	M20	UCP215	P215		UC215	67.4	48.3	14.5	UCP215C	UCP215CD	UCP215FC	UCP215FCD	98	124	7.4	9.3
	88.9	330	89	229	27	50	32	175	99	82.6	33.3	M22	UCPX15	PX15		UCX15	72.7	53.0	14.6	UCPX15C	UCPX15CD	—	—	108	—	10.8	—
	100	380	100	290	27	40	35	198	107	82	32	M22	UCP315	P315		UC315	113	77.2	13.2	—	—	UCP315C	UCP315CD	—	134	14.8	17.3
80	88.9	292	78	232	25	35	32	174	86	82.6	33.3	M20	UCP216	P216		UC216	72.7	53.0	14.6	UCP216C	UCP216CD	UCP216FC	UCP216FCD	108	138	9.0	11.4
	101.6	381	102	283	27	58	34	195	116	85.7	34.1	M22	UCPX16	PX16		UCX16	84.0	61.9	14.5	UCPX16C	UCPX16CD	—	—	112	—	15.3	—
	106	400	110	300	27	40	35	209	120	86	34	M22	UCP316	P316		UC316	123	86.7	13.3	—	—	UCP316C	UCP316CD	—	138	18.5	21.4
85	95.2	310	83	247	25	40	32	185	90	85.7	34.1	M20	UCP217	P217		UC217	84.0	61.9	14.5	UCP217C	UCP217CD	UCP217FC	UCP217FCD	112	142	10.8	13.5
	101.6	381	102	283	27	60	34	200	116	96	39.7	M22	UCPX17	PX17		UCX17	96.1	71.5	14.5	UCPX17C	UCPX17CD	—	—	122	—	16.1	—
	112	420	110	320	33	45	40	220	120	96	40	M27	UCP317	P317		UC317	133	96.8	13.3	—	—	UCP317C	UCP317CD	—	146	20.3	23.6
90	101.6	327	88	262	27	45	34	198	104	96	39.7	M22	UCP218	P218		UC218	96.1	71.5	14.5	UCP218C	UCP218CD	UCP218FC	UCP218FCD	122	152	13.9	17.0
	101.6	381	111	283	27	60	38	204	116	104	42.9	M22	UCPX18	PX18		UCX18	109	81.9	14.4	—	—	UCPX18C	UCPX18CD	—	158	19.1	22.5
	118	430	110	330	33	45	40	234	120	96	40	M27	UCP318	P318		UC318	143	107	13.3	—	—	UCP318C	UCP318CD	—	150	22.8	26.6
95	125	470	120	360	36	50	46	248	125	103	41	M30	UCP319	P319		UC319	153	119	13.3	—	—	UCP319C	UCP319CD	—	162	29.0	33.3

(Remarks) 1) Applicable sizes of grease nipples are shown below.
A-1/4-28UNF..... 201~210, X05~X09, 305~308
A-PT 1/8..... 211~218, X10~X20, 309~328

2) For bearings with double- or triple-lip seals, unit and bearing number are suffixed by L2 or L3.
3) For more detailed information, refer to ball bearing for unit specification tables.

**Ball bearing units
pillow block type
UCP (with set screws)**
d 100 ~ 140 mm

Tolerance for housing

unit : mm

housing No.			ΔH_s
P203~P210	PX05~PX10	P305~P310	± 0.15
P211~P218	PX11~PX18	P311~P318	± 0.2
	PX20	P319~P328	± 0.3

ΔH_s : deviation of distance from mounting base to centre of spherical bearing seating.

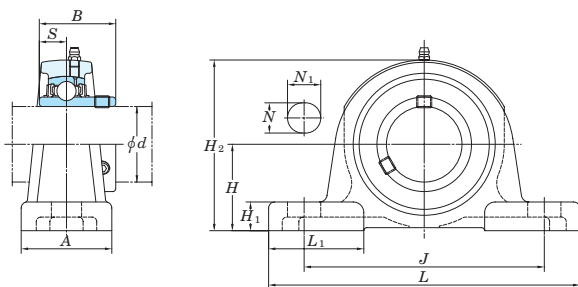

Pressed steel covers

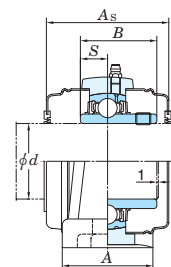

Cast iron covers

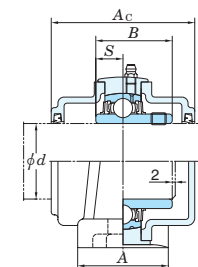

Shaft dia. (mm) <i>d</i>	Dimensions (mm)											Bolt size	Unit No.	Housing No.	Applicable bearing			Unit No. with covers				Cover dimensions (mm)		(Refer.) Unit mass (kg)		
	<i>H</i>	<i>L</i>	<i>A</i>	<i>J</i>	<i>N</i>	<i>N</i> ₁	<i>H</i> ₁	<i>H</i> ₂	<i>L</i> ₁	<i>B</i>	<i>S</i>				No.	Basic load ratings (kN)		Factor	Pressed steel covers		Cast iron covers		<i>A</i> _s	<i>A</i> _c	Pressed steel covers	Cast iron covers
	<i>C_r</i>	<i>C</i> _{0r}	<i>f</i> ₀	Open ends	Closed end	Open ends	Closed end	<i>A</i> _s	<i>A</i> _c	steel covers	covers															
100	127	432	121	337	33	65	45	245	126	117.5	49.2	M27	UCPX20	PX20	UCX20	133	105	14.4	—	—	UCPX20C	UCPX20CD	—	186	30.4	34.9
	140	490	120	380	36	50	46	273	140	108	42	M30	UCP320	P320	UC320	173	141	13.2	—	—	UCP320C	UCP320CD	—	174	35.1	40.7
105	140	490	120	380	36	50	46	278	140	112	44	M30	UCP321	P321	UC321	184	153	13.2	—	—	UCP321C	UCP321CD	—	178	37.6	43.6
110	150	520	140	400	40	55	50	296	150	117	46	M33	UCP322	P322	UC322	205	180	13.2	—	—	UCP322C	UCP322CD	—	188	44.0	50.8
120	160	570	140	450	40	55	50	316	160	126	51	M33	UCP324	P324	UC324	207	185	13.5	—	—	UCP324C	UCP324CD	—	196	55.4	64.9
130	180	600	140	480	40	55	50	355	195	135	54	M33	UCP326	P326	UC326	229	214	13.6	—	—	UCP326C	UCP326CD	—	214	72.1	84.2
140	200	620	140	500	40	55	60	393	185	145	59	M33	UCP328	P328	UC328	253	246	13.6	—	—	UCP328C	UCP328CD	—	222	92.5	108

[Remarks] 1) Applicable sizes of grease nipples are shown below.
 A-1/4-28UNF 201~210, X05~X09, 305~308
 A-PT 1/8 211~218, X10~X20, 309~328

2) For bearings with double- or triple-lip seals, unit and bearing number are suffixed by L2 or L3.
 3) For more detailed information, refer to ball bearing for unit specification tables.

Ball bearing units pillow block type UKP (with adapter)

d_1 20 ~ 55 mm

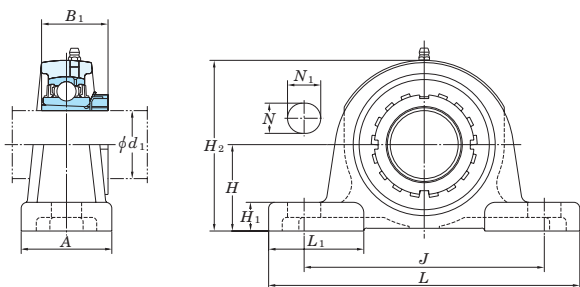

Pressed steel covers

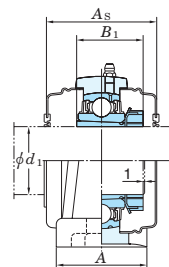

Cast iron covers

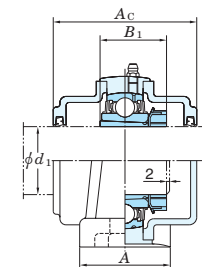

Tolerance for housing

housing No.			unit : mm
			ΔH_s
P205- P210	PX05- PX10	P305- P310	± 0.15
P211- P218	PX11- PX18	P311- P318	± 0.2
	PX20	P319- P328	± 0.3

ΔH_s : deviation of distance from mounting base to centre of spherical bearing seating.

P205JE3 (with cast iron covers) are shown below.

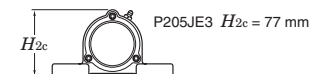

Shaft dia. (mm) d_1	Dimensions (mm)											Bolt size	Unit No.	Housing No.	Applicable bearing			Applicable ¹⁾ adapter No.	Unit No. with covers				Cover dimensions (mm)		(Refer.) Unit mass (kg)	
	H	L	A	J	N	N ₁	H ₁	H ₂	L ₁	B ₁ ¹⁾	C _r				C _{0r}	Factor f_0	Pressed steel covers		Cast iron covers		A _s	A _c	Pressed steel covers	Cast iron covers		
																	Open ends		Closed end	Open ends					Closed end	
20	36.5	140	38	105	13	18	13	71	43	29(35)	M10	UKP205	P205	UK205	14.0	7.85	13.9	H305X(H2305X)	UKP205C	UKP205CD	UKP205FC	UKP205FCD	48	66	0.84	1.3
	44.4	159	51	119	17	25	16	86	47	35	M14	UKPX05	PX05	UKX05	19.5	11.3	13.9	H2305X	UKPX05C	UKPX05CD	—	—	52	—	1.5	—
	45	175	45	132	17	20	16	85	55	35	M14	UKP305	P305	UK305	21.2	10.9	12.6	H2305X	—	—	UKP305C	UKP305CD	—	76	1.7	2.3
25	42.9	165	48	121	17	21	15	84	53	31(38)	M14	UKP206	P206	UK206	19.5	11.3	13.9	H306X(H2306X)	UKP206C	UKP206CD	UKP206FC	UKP206FCD	52	70	1.4	1.9
	47.6	175	57	127	17	25	17	93	55	38	M14	UKPX06	PX06	UKX06	25.7	15.4	13.9	H2306X	UKPX06C	UKPX06CD	—	—	59	—	2.1	—
	50	180	50	140	17	20	17	95	53	38	M14	UKP306	P306	UK306	26.7	15.0	13.3	H2306X	—	—	UKP306C	UKP306CD	—	82	2.3	2.9
30	47.6	167	48	127	17	21	16	93	51	35(43)	M14	UKP207	P207	UK207	25.7	15.4	13.9	H307X(H2307X)	UKP207C	UKP207CD	UKP207FC	UKP207FCD	59	78	1.7	2.5
	54	203	57	144	17	30	19	105	64	43	M14	UKPX07	PX07	UKX07	29.1	17.8	14.0	H2307X	UKPX07C	UKPX07CD	—	—	68	—	2.7	—
	56	210	56	160	17	25	19	107	65	43	M14	UKP307	P307	UK307	33.4	19.3	13.2	H2307X	—	—	UKP307C	UKP307CD	—	88	3.0	3.9
35	49.2	184	54	137	17	21	17	98	57	36(46)	M14	UKP208	P208	UK208	29.1	17.8	14.0	H308X(H2308X)	UKP208C	UKP208CD	UKP208FC	UKP208FCD	68	86	2.0	2.9
	58.7	222	67	156	20	32	21	114	71	46	M16	UKPX08	PX08	UKX08	32.7	20.3	14.0	H2308X	UKPX08C	UKPX08CD	—	—	68	—	3.5	—
	60	220	60	170	17	27	19	118	65	46	M14	UKP308	P308	UK308	40.7	24.0	13.2	H2308X	—	—	UKP308C	UKP308CD	—	96	3.8	5.2
40	54	190	54	146	17	21	17	106	60	39(50)	M14	UKP209	P209	UK209	32.7	20.3	14.0	H309X(H2309X)	UKP209C	UKP209CD	UKP209FC	UKP209FCD	68	88	2.3	3.2
	58.7	222	67	156	20	33	21	116	71	50	M16	UKPX09	PX09	UKX09	35.1	23.3	14.4	H2309X	UKPX09C	UKPX09CD	—	—	73	—	3.7	—
	67	245	67	190	20	30	21	132	75	50	M16	UKP309	P309	UK309	48.9	29.5	13.3	H2309X	—	—	UKP309C	UKP309CD	—	102	5.0	6.3
45	57.2	206	60	159	20	22	19	113	63	42(55)	M16	UKP210	P210	UK210	35.1	23.3	14.4	H310X(H2310X)	UKP210C	UKP210CD	UKP210FC	UKP210FCD	73	97	3.0	4.1
	63.5	241	73	171	20	36	22	126	76	55	M16	UKPX10	PX10	UKX10	43.4	29.4	14.4	H2310X	UKPX10C	UKPX10CD	—	—	75	—	4.6	—
	75	275	75	212	20	35	24	148	88	55	M16	UKP310	P310	UK310	62.0	38.3	13.2	H2310X	—	—	UKP310C	UKP310CD	—	110	6.7	8.4
50	63.5	219	60	171	20	22	19	125	70	45(59)	M16	UKP211	P211	UK211	43.4	29.4	14.4	H311X(H2311X)	UKP211C	UKP211CD	UKP211FC	UKP211FCD	75	99	3.7	5.0
	69.8	260	79	184	25	36	28	139	83	59	M20	UKPX11	PX11	UKX11	52.4	36.2	14.4	H2311X	UKPX11C	UKPX11CD	—	—	88	—	6.2	—
	80	310	80	236	20	38	27	158	90	59	M16	UKP311	P311	UK311	71.6	45.0	13.2	H2311X	—	—	UKP311C	UKP311CD	—	114	8.1	10.0
55	69.8	241	70	184	20	25	22	138	76	47(62)	M16	UKP212	P212	UK212	52.4	36.2	14.4	H312X(H2312X)	UKP212C	UKP212CD	UKP212FC	UKP212FCD	88	114	4.8	6.3
	76.2	286	83	203	25	40	28	152	88	62	M20	UKPX12	PX12	UKX12	57.2	40.1	14.4	H2312X	UKPX12C	UKPX12CD	—	—	88	—	7.5	—
	85	330	85	250	25	38	29	167	103	62	M20	UKP312	P312	UK312	81.9	52.2	13.2	H2312X	—	—	UKP312C	UKP312CD	—	124	9.4	11.8

[Note] 1) () Shown for use triple lip seal bearing and applicable adapter No.(H2300X series).

[Remarks] 1) Applicable sizes of grease nipples are shown below.

A-1/4-28UNF 205-210, X05-X09, 305-308

A-PT 1/8 211-218, X10-X20, 309-328

2) Unit No. means housing and bearing assembly, whole complete unit No. is given follows.

(UKP206+H306X, UK206+H306X)

3) For bearings with double- or triple-lip seals, unit and bearing number are suffixed by L2 or L3.

(UKP206JL3+H2306X, UK206L3+H2306X)

4) For more detailed information, refer to ball bearing for unit specification tables. Not applied to UKX series.

**Ball bearing units
pillow block type
UKP (with adapter)**
 d_1 60 ~ 125 mm

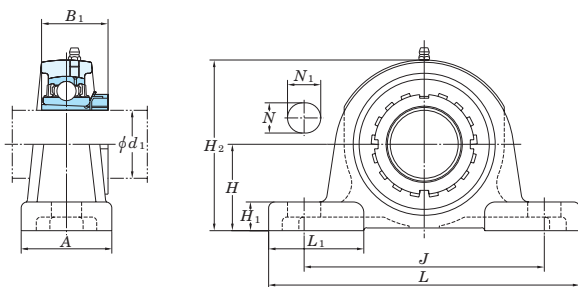

Pressed steel covers

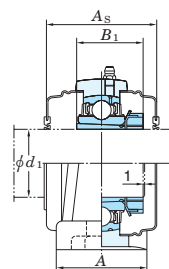

Cast iron covers

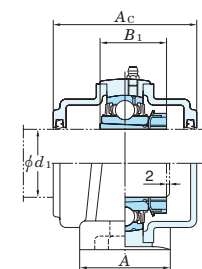

Tolerance for housing

housing No.			unit : mm ΔH_s
P205- P210	PX05- PX10	P305- P310	± 0.15
P211- P218	PX11- PX18	P311- P318	± 0.2
	PX20	P319- P328	± 0.3

ΔH_s : deviation of distance from mounting base to centre of spherical bearing seating.

Shaft dia. (mm) d_1	Dimensions (mm)										Bolt size	Unit No.	Housing No.	Applicable bearing			Applicable ¹⁾ adapter No.	Unit No. with covers				Cover dimensions (mm) A_s A_c		(Refer.) Unit mass (kg) Pressed steel covers Cast iron covers		
	H	L	A	J	N	N_1	H_1	H_2	L_1	B_1 ¹⁾				No.	Basic load ratings (kN) C_r C_{0r}	Factor f_0		Pressed steel covers Open ends Closed end	Cast iron covers Open ends Closed end	A_s	A_c	Pressed steel covers	Cast iron covers			
	60	76.2 76.2 90	265 286 340	70 83 90	203 203 260	25 25 25	30 40 38	25 28 32	150 155 176	78 88 110				50(65) 65 65	M20 M20 M20	UKP213 UKPX13 UKP313		P213 PX13 P313	UK213 UKX13 UK313	57.2 62.2 92.7	40.1 44.1 59.9	14.4 14.5 13.2	H313X(H2313X) H2313X H2313X	UKP213C UKPX13C —	UKP213CD UKPX13CD —	UKP213FC — UKP313C
65	82.6 88.9 100	275 330 380	74 89 100	217 229 290	25 27 27	30 50 40	28 32 35	162 175 198	80 99 107	55(73) 73 73	M20 M22 M22	UKP215 UKPX15 UKP315	P215 PX15 P315	UK215 UKX15 UK315	67.4 72.7 113	48.3 53.0 77.2	14.5 14.6 13.2	H315X(H2315X) H2315X H2315X	UKP215C UKPX15C —	UKP215CD UKPX15CD —	UKP215FC — UKP315C	UKP215FCD — UKP315CD	98 108 —	124 — 134	7.5 10.5 14.9	9.5 — 17.7
70	88.9 101.6 106	292 381 400	78 102 110	232 283 300	25 27 27	35 60 40	32 34 35	174 195 209	86 116 120	59(78) 78 78	M20 M22 M22	UKP216 UKPX16 UKP316	P216 PX16 P316	UK216 UKX16 UK316	72.7 84.0 123	53.0 61.9 86.7	14.6 14.5 13.3	H316X(H2316X) H2316X H2316X	UKP216C UKPX16C —	UKP216CD UKPX16CD —	UKP216FC — UKP316C	UKP216FCD — UKP316CD	108 112 —	138 — 138	9.2 15.4 18.6	11.7 — 21.7
75	95.2 101.6 112	310 381 420	83 102 110	247 283 320	25 27 33	40 60 45	32 34 40	185 200 220	90 116 120	63(82) 82 82	M20 M22 M27	UKP217 UKPX17 UKP317	P217 PX17 P317	UK217 UKX17 UK317	84.0 96.1 133	61.9 71.5 96.8	14.5 14.5 13.3	H317X(H2317X) H2317X H2317X	UKP217C UKPX17C —	UKP217CD UKPX17CD —	UKP217FC — UKP317C	UKP217FCD — UKP317CD	112 122 —	142 — 146	11.0 15.8 20.2	13.8 — 23.7
80	101.6 101.6 118	327 381 430	88 111 110	262 283 330	27 27 33	45 60 45	34 38 40	198 204 234	104 116 120	65(86) 86 86	M22 M22 M27	UKP218 UKPX18 UKP318	P218 PX18 P318	UK218 UKX18 UK318	96.1 109 143	71.5 81.9 107	14.5 14.4 13.3	H318X(H2318X) H2318X H2318X	UKP218C — —	UKP218CD — —	UKP218FC UKPX18C UKP318C	UKP218FCD UKPX18CD UKP318CD	122 — —	152 158 150	13.8 18.6 22.8	18.8 22.4 27.0
85	125	470	120	360	36	50	46	248	125	90	M30	UKP319	P319	UK319	153	119	13.3	H2319X	—	—	UKP319C	UKP319CD	—	162	29.3	34.0
90	127 140	432 490	121 120	337 380	33 36	65 50	45 46	245 273	126 140	97 97	M27 M30	UKPX20 UKP320	PX20 P320	UKX20 UK320	133 173	105 141	14.4 13.2	H2320X H2320X	— —	— —	UKPX20C UKP320C	UKP20CD UKP320CD	— —	186 174	29.3 34.8	34.3 41.0
100	150	520	140	400	40	55	50	296	150	105	M33	UKP322	P322	UK322	205	180	13.2	H2322X	—	—	UKP322C	UKP322CD	—	188	43.9	50.8
110	160	570	140	450	40	55	50	316	160	112	M33	UKP324	P324	UK324	207	185	13.5	H2324	—	—	UKP324C	UKP324CD	—	196	55.7	66.0
115	180	600	140	480	40	55	50	355	195	121	M33	UKP326	P326	UK326	229	214	13.6	H2326	—	—	UKP326C	UKP326CD	—	214	71.9	85.2
125	200	620	140	500	40	55	60	393	185	131	M33	UKP328	P328	UK328	253	246	13.6	H2328	—	—	UKP328C	UKP328CD	—	222	92.5	109

[Note] 1) () Shown for use triple lip seal bearing and applicable adapter No.(H2300X series).

[Remarks] 1) Applicable sizes of grease nipples are shown below.
A-1/4-28UNF..... 205~210, X05~X09, 305~308
A-PT 1/8..... 211~218, X10~X20, 309~328

2) Unit No. means housing and bearing assembly, whole complete unit No. is given follows.
(UKP206+H306X, UK206+H306X)

3) For bearings with double- or triple-lip seals, unit and bearing number are suffixed by L2 or L3.
(UKP206JL3+H2306X, UK206L3+H2306X)

4) For more detailed information, refer to ball bearing for unit specification tables. Not applied to UKX series.

**Ball bearing units
thick section pillow block type
UCIP (with set screws)**

d 40 ~ 140 mm

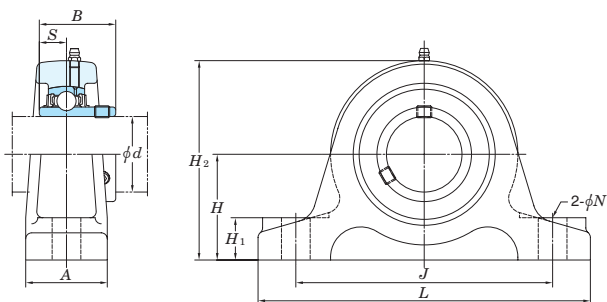

Pressed steel covers

Cast iron covers

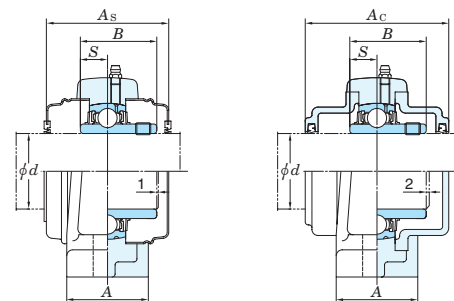

Tolerances for housing

unit : mm

housing No.	ΔH_s	X
IP208~ IP210	± 0.15	1
IP211~ IP213	± 0.2	1.4
IP319~ IP328	± 0.3	

ΔH_s : deviation of distance from mounting base to centre of spherical bearing seating.
X : positional tolerance of bolt hole.

Shaft dia. (mm) d	Dimensions (mm)									Bolt size	Unit No.	Housing No.	Applicable bearing			Unit No. with covers				Cover dimensions (mm)		(Refer.) Unit mass (kg)		
	H	L	A	J	N	H_1	H_2	B	S				No.	Basic load ratings (kN) C_r C_{0r}	Factor f_0	Pressed steel covers		Cast iron covers		A_s	A_c	Pressed steel covers	Cast iron covers	
	Open ends	Closed end	Open ends	Closed end																				
40	60	200	60	150	19	25	115	49.2	19	M16	UCIP208	IP208	UC208	29.1	17.8	14.0	UCIP208C	UCIP208CD	UCIP208FC	UCIP208FCD	68	86	3.4	4.2
45	70	210	60	160	19	25	128	49.2	19	M16	UCIP209	IP209	UC209	32.7	20.3	14.0	UCIP209C	UCIP209CD	UCIP209FC	UCIP209FCD	68	88	3.9	4.7
50	70	220	60	170	19	28	132	51.6	19	M16	UCIP210	IP210	UC210	35.1	23.3	14.4	UCIP210C	UCIP210CD	UCIP210FC	UCIP210FCD	73	97	4.8	5.8
55	80	230	60	180	19	28	148	55.6	22.2	M16	UCIP211	IP211	UC211	43.4	29.4	14.4	UCIP211C	UCIP211CD	UCIP211FC	UCIP211FCD	75	99	5.3	6.3
60	80	260	70	200	22	30	155	65.1	25.4	M20	UCIP212	IP212	UC212	52.4	36.2	14.4	UCIP212C	UCIP212CD	UCIP212FC	UCIP212FCD	88	114	7.2	8.7
65	90	280	70	220	22	30	172	65.1	25.4	M20	UCIP213	IP213	UC213	57.2	40.1	14.4	UCIP213C	UCIP213CD	UCIP213FC	UCIP213FCD	88	114	8.8	10.5
	110	310	70	250	22	30	208	75	30	M20	UCIP313	IP313	UC313	92.7	59.9	13.2	—	—	UCIP313C	UCIP313CD	—	122	13.4	15.5
70	110	330	75	270	25	35	215	78	33	M22	UCIP314	IP314	UC314	104	68.2	13.2	—	—	UCIP314C	UCIP314CD	—	124	15.3	17.6
75	120	340	75	280	25	35	230	82	32	M22	UCIP315	IP315	UC315	113	77.2	13.2	—	—	UCIP315C	UCIP315CD	—	134	17.6	20.1
80	120	350	85	290	25	40	235	86	34	M22	UCIP316	IP316	UC316	123	86.7	13.3	—	—	UCIP316C	UCIP316CD	—	138	20.3	23.2
85	130	370	85	310	25	40	255	96	40	M22	UCIP317	IP317	UC317	133	96.8	13.3	—	—	UCIP317C	UCIP317CD	—	146	25.9	29.2
90	130	400	85	330	29	45	260	96	40	M27	UCIP318	IP318	UC318	143	107	13.3	—	—	UCIP318C	UCIP318CD	—	150	28.6	32.4
95	150	410	85	340	29	45	285	103	41	M27	UCIP319	IP319	UC319	153	119	13.3	—	—	UCIP319C	UCIP319CD	—	162	31.7	36.0
100	150	430	85	360	29	45	295	108	42	M27	UCIP320	IP320	UC320	173	141	13.2	—	—	UCIP320C	UCIP320CD	—	174	36.9	42.5
110	170	490	100	410	32	50	335	117	46	M30	UCIP322	IP322	UC322	205	180	13.2	—	—	UCIP322C	UCIP322CD	—	188	52.4	59.2
120	170	510	100	430	32	50	345	126	51	M30	UCIP324	IP324	UC324	207	185	13.5	—	—	UCIP324C	UCIP324CD	—	196	58.7	68.2
130	200	550	110	470	32	50	390	135	54	M30	UCIP326	IP326	UC326	229	214	13.6	—	—	UCIP326C	UCIP326CD	—	214	76.2	88.3
140	200	590	110	500	35	55	400	145	59	M33	UCIP328	IP328	UC328	253	246	13.6	—	—	UCIP328C	UCIP328CD	—	222	87.0	102

(Remarks) 1) Applicable sizes of grease nipples are shown below.
A-1/4-28UNF 208~210
A-PT 1/8 211~213, 313~328

2) Bearings with triple-lip seals are indicated by L3 after the bearing and unit number.
(UCIP208JL3, UC208L3)
3) For more detailed information, refer to ball bearing for unit specification tables.

Ball bearing units
light duty pillow block type
BLP (with set screws)
d 12 ~ 40 mm

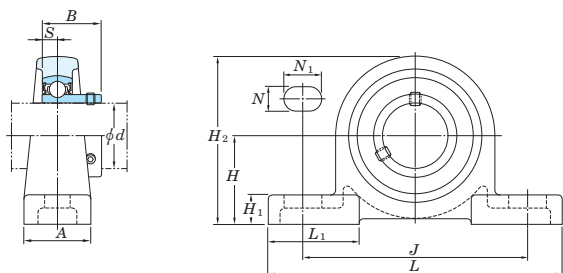

Shaft dia. (mm)	Dimensions (mm)											Bolt size	Unit No.	Housing No.	No.	Applicable bearing			(Refer.) Unit mass (kg)
	<i>H</i> ±0.15	<i>L</i>	<i>A</i>	<i>J</i>	<i>N</i>	<i>N</i> ₁	<i>H</i> ₁	<i>H</i> ₂	<i>L</i> ₁	<i>B</i>	<i>S</i>					Basic load ratings (kN)		Factor	
<i>d</i>																<i>C</i> _r	<i>C</i> _{0r}	<i>f</i> ₀	
12	30.2	114	25	87	11	16	12	57	35	22	6	M10	BLP201	LP203	SB201	9.55	4.80	13.2	0.36
15	30.2	114	25	87	11	16	12	57	35	22	6	M10	BLP202	LP203	SB202	9.55	4.80	13.2	0.36
17	30.2	114	25	87	11	16	12	57	35	22	6	M10	BLP203	LP203	SB203	9.55	4.80	13.2	0.36
20	33.3	125	27	97	11	16	13	65	38	25	7	M10	BLP204	LP204	SB204	12.8	6.65	13.2	0.51
25	36.5	130	29	100	11	16	13	71	39	27	7.5	M10	BLP205	LP205	SB205	14.0	7.85	13.9	0.57
30	42.9	156	33	120	14	21	14	83	47	30	8	M12	BLP206	LP206	SB206	19.5	11.3	13.9	0.69
35	47.6	165	35	127	14	21	16	93	50	32	8.5	M12	BLP207	LP207	SB207	25.7	15.4	13.9	0.94
40	50.8	184	37	140	14	22	18	102	55	34	9	M12	BLP208	LP208	SB208	29.1	17.8	14.0	1.8

[Remarks] 1) The radial loading on housing should not exceed 50% of the basic load rating (*C_r*).
 2) For more detailed information, refer to ball bearing for unit specification tables.

Ball bearing units
“compact” series pillow block type

UP (with set screws)

d 10 ~ 30 mm

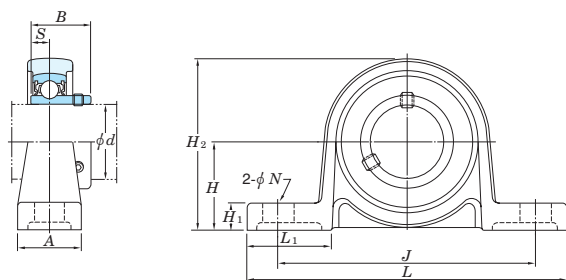

Open ends type

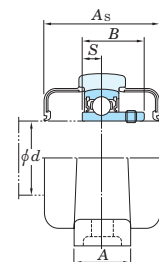

Closed end type

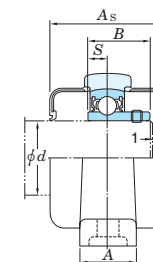

Tolerance for housing

unit : mm	
housing No.	X
P000-P006	0.6

X : positional tolerance of bolt hole.

Shaft dia. (mm) <i>d</i>	Dimensions (mm)										Bolt size	Unit No.	Housing No.	No.	Applicable bearing			Unit No. with covers		Cover dimension (mm) <i>A_s</i>	(Refer.) Unit mass (kg)
	<i>H</i> ±0.15	<i>L</i>	<i>A</i>	<i>J</i>	<i>N</i> ±0.2	<i>H</i> ₁	<i>H</i> ₂	<i>L</i> ₁	<i>B</i>	<i>S</i>					Basic load ratings (kN)	Factor	Open ends	Closed end			
													<i>C_r</i>	<i>C_{0r}</i>	<i>f</i> ₀						
10	18	67	16	53	7	6	35	18	15	5	M6	UP000	P000	SU000	4.55	1.95	12.3	UP000C	UP000CD	29	0.070
12	19	71	16	56	7	6	38	19	15	5	M6	UP001	P001	SU001	5.10	2.40	13.2	UP001C	UP001CD	29	0.090
15	22	80	16	63	7	7	43	21	16.5	5.5	M6	UP002	P002	SU002	5.60	2.85	13.9	UP002C	UP002CD	31	0.11
17	24	85	18	67	7	7	47	21	17.5	6	M6	UP003	P003	SU003	6.00	3.25	14.4	UP003C	UP003CD	33	0.15
20	28	100	20	80	10	9	55	25	21	7	M8	UP004	P004	SU004	9.40	5.05	13.9	UP004C	UP004CD	38	0.23
25	32	112	20	90	10	10	62	28	22	7	M8	UP005	P005	SU005	10.1	5.85	14.5	UP005C	UP005CD	40	0.28
30	36	132	26	106	13	11	70	34	24.5	7.5	M10	UP006	P006	SU006	13.2	8.25	14.7	UP006C	UP006CD	44	0.42

- [Remarks] 1) Housing is made from special light alloy.
 2) For more detailed information, refer to ball bearing for unit specification tables.

Ball bearing units
stainless-series pillow block type
UCSP-H1S6 (with set screws)

d 12 ~ 50 mm

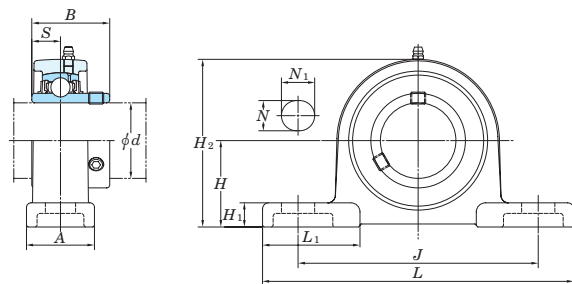

Pressed stainless steel covers

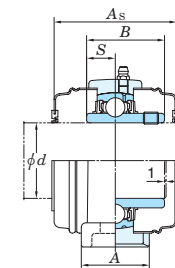

Shaft dia. (mm) <i>d</i>	Dimensions (mm)											Bolt size	Unit No.	Housing No.	No.	Applicable bearing			Unit No. with covers		Cover dimension (mm) <i>A_s</i>	(Refer.) Unit mass (kg) Pressed steel covers
	<i>H</i> ±0.15	<i>L</i>	<i>A</i>	<i>J</i>	<i>N</i>	<i>N₁</i>	<i>H₁</i>	<i>H₂</i>	<i>L₁</i>	<i>B</i>	<i>S</i>					Basic load ratings (kN) <i>C_r</i> <i>C_{0r}</i>	Factor <i>f₀</i>	Open ends	Closed end			
12	30.2	127	30	95	13	18	11	56	42	27.4	11.5	M10	UCSP201XH1S6	SP203H1	UC201XS6	8.15	3.85	13.2	—	—	—	0.42
15	30.2	127	30	95	13	18	11	56	42	27.4	11.5	M10	UCSP202XH1S6	SP203H1	UC202XS6	8.15	3.85	13.2	—	—	—	0.42
17	30.2	127	30	95	13	18	11	56	42	27.4	11.5	M10	UCSP203XH1S6	SP203H1	UC203XS6	8.15	3.85	13.2	—	—	—	0.42
20	33.3	127	30	95	13	18	11	63	42	31	12.7	M10	UCSP204H1S6	SP204H1	UC204S6	10.9	5.35	13.2	UCSP204H1CS6	UCSP204H1CDS6	45	0.54
25	36.5	140	30	105	13	19	12	69	46	34.1	14.3	M10	UCSP205H1S6	SP205H1	UC205S6	11.9	6.30	13.9	UCSP205H1CS6	UCSP205H1CDS6	49	0.70
30	42.9	165	36	121	17	21	13	81	54	38.1	15.9	M14	UCSP206H1S6	SP206H1	UC206S6	16.5	9.05	13.9	UCSP206H1CS6	UCSP206H1CDS6	53	1.0
35	47.6	167	38	127	17	21	14	91	51	42.9	17.5	M14	UCSP207H1S6	SP207H1	UC207S6	21.8	12.3	13.9	UCSP207H1CS6	UCSP207H1CDS6	60	1.4
40	49.2	184	40	137	17	21	14	97	60	49.2	19	M14	UCSP208H1S6	SP208H1	UC208S6	24.8	14.3	14.0	UCSP208H1CS6	UCSP208H1CDS6	69	1.7
45	54	190	40	146	17	21	15	104	61	49.2	19	M14	UCSP209H1S6	SP209H1	UC209S6	27.8	16.2	14.0	UCSP209H1CS6	UCSP209H1CDS6	69	1.8
50	57.2	206	45	159	20	22	16	111	65	51.6	19	M16	UCSP210H1S6	SP210H1	UC210S6	29.8	18.6	14.4	UCSP210H1CS6	UCSP210H1CDS6	74	2.3

[Remarks] 1) Applicable size of grease nipples is A-1/4-28UNF.

2) For more detailed information, refer to ball bearing for unit specification tables.

Ball bearing units
pressed steel pillow block type
SBPP

d 12 ~ 35 mm

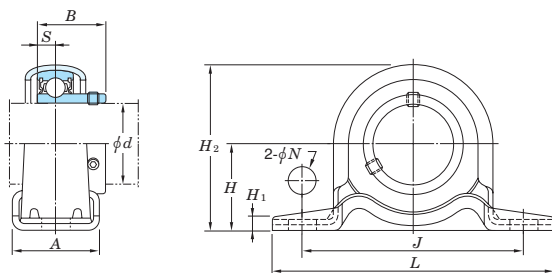

Shaft dia. (mm)	Dimensions (mm)									Bolt size	Unit No.	Housing No.	No.	Applicable bearing			(Refer.) Unit mass (kg)
	<i>H</i>	<i>L</i>	<i>A</i>	<i>J</i> ±0.4	<i>N</i> ±0.5	<i>H</i> ₁	<i>H</i> ₂	<i>B</i>	<i>S</i>					Basic load ratings (kN)	Factor	<i>C</i> _r	
12	22.2	86	25	68	9.5	3.2	43.8	22	6	M8	SBPP201	PP203F	SB201	9.55	4.80	13.2	0.16
15	22.2	86	25	68	9.5	3.2	43.8	22	6	M8	SBPP202	PP203F	SB202	9.55	4.80	13.2	0.16
17	22.2	86	25	68	9.5	3.2	43.8	22	6	M8	SBPP203	PP203F	SB203	9.55	4.80	13.2	0.16
20	25.4	98	32	76	9.5	3.2	50.5	25	7	M8	SBPP204	PP204F	SB204	12.8	6.65	13.2	0.23
25	28.6	108	32	86	11.5	4	56.6	27	7.5	M10	SBPP205	PP205F	SB205	14.0	7.85	13.9	0.28
30	33.3	117	38	95	11.5	4	66.3	30	8	M10	SBPP206	PP206F	SB206	19.5	11.3	13.9	0.47
35	39.7	129	41	106	11.5	4.6	78	32	8.5	M10	SBPP207	PP207F	SB207	25.7	15.4	13.9	0.67

[Remark] 1) For more detailed information, refer to ball bearing for unit specification tables.

**Ball bearing units
square-flanged type
UCF (with set screws)**

d 12 ~ (55) mm

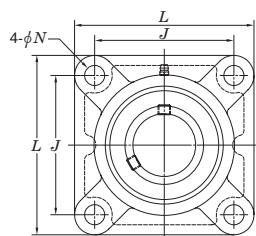
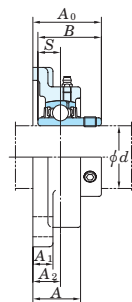

Pressed steel cover

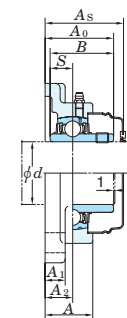

Cast iron cover

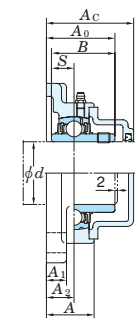

Tolerances for housing

unit : mm

housing No.			ΔA_{2s}	X
F204- F210	FX05- FX10	F305- F310	± 0.5	0.7
F211- F218	FX11- FX20	F311- F328	± 0.8	1

ΔA_{2s} : deviation of distance from mounting face to centre of spherical bearing seating.

X : positional tolerance of bolt hole.

unit : mm

housing No.			ΔN_s
F204- F218	FX05- FX18	F305- F315	± 0.2
	FX20	F316- F328	± 0.3

ΔN_s : deviation of bolt hole diameter.

Shaft dia. (mm) <i>d</i>	Dimensions (mm)									Bolt size	Unit No.	Housing No.	Applicable bearing			Unit No. with covers				Cover dimensions (mm)		(Refer.) Unit mass (kg)			
	<i>L</i>	<i>A</i>	<i>J</i>	<i>N</i>	<i>A</i> ₁	<i>A</i> ₂	<i>A</i> ₀	<i>B</i>	<i>S</i>				No.	Basic load ratings (kN)		Factor <i>f</i> ₀	Pressed steel covers		Cast iron covers		<i>A</i> _s	<i>A</i> _c	Pressed steel covers	Cast iron covers	
														<i>C</i> _r	<i>C</i> _{0r}		Open ends	Closed end	Open ends	Closed end					
12	86	25.5	64	12	11	15	33.3	31	12.7	M10	UCF201	F204	UC201	12.8	6.65	13.2	UCF201C	UCF201D	—	—	37	—	0.64	—	
	15	86	25.5	64	12	11	15	33.3	31	12.7	M10	UCF202	F204	UC202	12.8	6.65	13.2	UCF202C	UCF202D	—	—	37	—	0.62	—
		86	25.5	64	12	11	15	33.3	31	12.7	M10	UCF203	F204	UC203	12.8	6.65	13.2	UCF203C	UCF203D	—	—	37	—	0.61	—
20	86	25.5	64	12	11	15	33.3	31	12.7	M10	UCF204	F204	UC204	12.8	6.65	13.2	UCF204C	UCF204D	UCF204FC	UCF204FD	37	46	0.59	0.74	
	25	95	27	70	12	13	16	35.8	34.1	14.3	M10	UCF205	F205	UC205	14.0	7.85	13.9	UCF205C	UCF205D	UCF205FC	UCF205FD	40	49	0.83	1.0
		108	30	83	12	13	18	40.2	38.1	15.9	M10	UCFX05	FX05	UCX05	19.5	11.3	13.9	UCFX05C	UCFX05D	—	—	44	—	1.2	—
	110	29	80	16	13	16	39	38	15	M14	UCF305	F305	UC305	21.2	10.9	12.6	—	—	UCF305C	UCF305D	—	54	1.3	1.6	
30	108	31	83	12	13	18	40.2	38.1	15.9	M10	UCF206	F206	UC206	19.5	11.3	13.9	UCF206C	UCF206D	UCF206FC	UCF206FD	44	53	1.1	1.4	
	117	34	92	16	14	19	44.4	42.9	17.5	M14	UCFX06	FX06	UCX06	25.7	15.4	13.9	UCFX06C	UCFX06D	—	—	49	—	1.6	—	
	125	32	95	16	15	18	44	43	17	M14	UCF306	F306	UC306	26.7	15.0	13.3	—	—	UCF306C	UCF306D	—	59	1.9	2.2	
35	117	34	92	14	15	19	44.4	42.9	17.5	M12	UCF207	F207	UC207	25.7	15.4	13.9	UCF207C	UCF207D	UCF207FC	UCF207FD	49	58	1.5	1.9	
	130	38	102	16	14	21	51.2	49.2	19	M14	UCFX07	FX07	UCX07	29.1	17.8	14.0	UCFX07C	UCFX07D	—	—	55	—	2.0	—	
	135	36	100	19	16	20	49	48	19	M16	UCF307	F307	UC307	33.4	19.3	13.2	—	—	UCF307C	UCF307D	—	64	2.3	2.7	
40	130	36	102	16	15	21	51.2	49.2	19	M14	UCF208	F208	UC208	29.1	17.8	14.0	UCF208C	UCF208D	UCF208FC	UCF208FD	55	64	1.9	2.3	
	137	40	105	19	14	22	52.2	49.2	19	M16	UCFX08	FX08	UCX08	32.7	20.3	14.0	UCFX08C	UCFX08D	—	—	56	—	2.4	—	
	150	40	112	19	17	23	56	52	19	M16	UCF308	F308	UC308	40.7	24.0	13.2	—	—	UCF308C	UCF308D	—	71	3.1	3.6	
45	137	38	105	16	16	22	52.2	49.2	19	M14	UCF209	F209	UC209	32.7	20.3	14.0	UCF209C	UCF209D	UCF209FC	UCF209FD	56	66	2.2	2.6	
	143	40	111	19	14	23	55.6	51.6	19	M16	UCFX09	FX09	UCX09	35.1	23.3	14.4	UCFX09C	UCFX09D	—	—	60	—	2.7	—	
	160	44	125	19	18	25	60	57	22	M16	UCF309	F309	UC309	48.9	29.5	13.3	—	—	UCF309C	UCF309D	—	76	4.0	4.6	
50	143	40	111	16	16	22	54.6	51.6	19	M14	UCF210	F210	UC210	35.1	23.3	14.4	UCF210C	UCF210D	UCF210FC	UCF210FD	59	70.5	2.5	3.0	
	162	44	130	19	20	26	59.4	55.6	22.2	M16	UCFX10	FX10	UCX10	43.4	29.4	14.4	UCFX10C	UCFX10D	—	—	64	—	3.7	—	
	175	48	132	23	19	28	67	61	22	M20	UCF310	F310	UC310	62.0	38.3	13.2	—	—	UCF310C	UCF310D	—	83	5.1	5.9	
55	162	43	130	19	18	25	58.4	55.6	22.2	M16	UCF211	F211	UC211	43.4	29.4	14.4	UCF211C	UCF211D	UCF211FC	UCF211FD	63	74.5	3.4	4.0	

[Remarks] 1) Applicable sizes of grease nipples are shown below.
A-1/4-28UNF 201~210, X05~X09, 305~308
A-PT 1/8 211~218, X10~X20, 309~328

2) For bearings with double- or triple-lip seals, unit and bearing number are suffixed by L2 or L3.
(UCF206JL3, UC206L3)

3) For more detailed information, refer to ball bearing for unit specification tables.

Ball bearing units
square-flanged type
UCF (with set screws)

d (55) ~ 95 mm

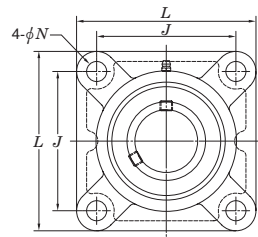
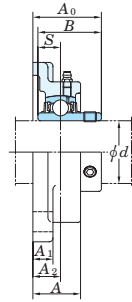

Pressed steel cover

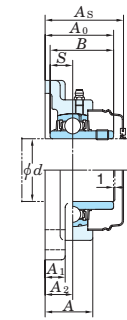

Cast iron cover

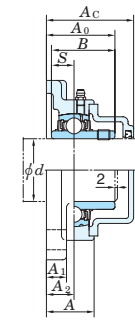

Tolerances for housing

unit : mm

housing No.			ΔA_{2s}	X
F204- F210	FX05- FX10	F305- F310	± 0.5	0.7
F211- F218	FX11- FX20	F311- F328	± 0.8	1

ΔA_{2s} : deviation of distance from mounting face to centre of spherical bearing seating.

X : positional tolerance of bolt hole.

unit : mm

housing No.			ΔN_s
F204- F218	FX05- FX18	F305- F315	± 0.2
	FX20	F316- F328	± 0.3

ΔN_s : deviation of bolt hole diameter.

Shaft dia. (mm) <i>d</i>	Dimensions (mm)									Bolt size	Unit No.	Housing No.	Applicable bearing			Unit No. with covers				Cover dimensions (mm)		(Refer.) Unit mass (kg)			
	<i>L</i>	<i>A</i>	<i>J</i>	<i>N</i>	<i>A</i> ₁	<i>A</i> ₂	<i>A</i> ₀	<i>B</i>	<i>S</i>				No.	Basic load ratings (kN)		Factor		Pressed steel covers		Cast iron covers		<i>A</i> _s	<i>A</i> _c	Pressed steel covers	Cast iron covers
	<i>C</i> _r	<i>C</i> _{0r}	<i>f</i> ₀	Open ends	Closed end	Open ends	Closed end																		
55	175	49	143	19	20	29	68.7	65.1	25.4	M16	UCFX11	FX11	UCX11	52.4	36.2	14.4	UCFX11C	UCFX11D	—	—	73	—	4.9	—	
	185	52	140	23	20	30	71	66	25	M20	UCF311	F311	UC311	71.6	45.0	13.2	—	—	UCF311C	UCF311D	—	87	5.6	6.5	
60	175	48	143	19	18	29	68.7	65.1	25.4	M16	UCF212	F212	UC212	52.4	36.2	14.4	UCF212C	UCF212D	UCF212FC	UCF212FD	73	86	4.2	5.0	
	187	59	149	19	21	34	73.7	65.1	25.4	M16	UCFX12	FX12	UCX12	57.2	40.1	14.4	UCFX12C	UCFX12D	—	—	78	—	5.7	—	
	195	56	150	23	22	33	78	71	26	M20	UCF312	F312	UC312	81.9	52.2	13.2	—	—	UCF312C	UCF312D	—	95	6.9	8.1	
65	187	50	149	19	22	30	69.7	65.1	25.4	M16	UCF213	F213	UC213	57.2	40.1	14.4	UCF213C	UCF213D	UCF213FC	UCF213FD	74	87	5.2	6.0	
	187	59	149	19	21	34	78.4	74.6	30.2	M16	UCFX13	FX13	UCX13	62.2	44.1	14.5	UCFX13C	UCFX13D	—	—	83	—	6.3	—	
	208	58	166	23	22	33	78	75	30	M20	UCF313	F313	UC313	92.7	59.9	13.2	—	—	UCF313C	UCF313D	—	94	7.8	8.9	
70	193	54	152	19	22	31	75.4	74.6	30.2	M16	UCF214	F214	UC214	62.2	44.1	14.5	UCF214C	UCF214D	UCF214FC	UCF214FD	80	93	5.9	6.8	
	197	60	152	23	22	37	81.5	77.8	33.3	M20	UCFX14	FX14	UCX14	67.4	48.3	14.5	UCFX14C	UCFX14D	—	—	86	—	7.0	—	
	226	61	178	25	25	36	81	78	33	M22	UCF314	F314	UC314	104	68.2	13.2	—	—	UCF314C	UCF314D	—	98	10.1	11.2	
75	200	56	159	19	22	34	78.5	77.8	33.3	M16	UCF215	F215	UC215	67.4	48.3	14.5	UCF215C	UCF215D	UCF215FC	UCF215FD	83	96	6.4	7.4	
	197	68	152	23	24	40	89.3	82.6	33.3	M20	UCFX15	FX15	UCX15	72.7	53.0	14.6	UCFX15C	UCFX15D	—	—	94	—	8.4	—	
	236	66	184	25	25	39	89	82	32	M22	UCF315	F315	UC315	113	77.2	13.2	—	—	UCF315C	UCF315D	—	106	11.6	12.9	
80	208	58	165	23	22	34	83.3	82.6	33.3	M20	UCF216	F216	UC216	72.7	53.0	14.6	UCF216C	UCF216D	UCF216FC	UCF216FD	88	103	7.3	8.5	
	214	70	171	23	24	40	91.6	85.7	34.1	M20	UCFX16	FX16	UCX16	84.0	61.9	14.5	UCFX16C	UCFX16D	—	—	96	—	9.4	—	
	250	68	196	31	27	38	90	86	34	M27	UCF316	F316	UC316	123	86.7	13.3	—	—	UCF316C	UCF316D	—	107	12.8	14.2	
85	220	63	175	23	24	36	87.6	85.7	34.1	M20	UCF217	F217	UC217	84.0	61.9	14.5	UCF217C	UCF217D	UCF217FC	UCF217FD	92	107	8.9	10.3	
	214	70	171	23	24	40	96.3	96	39.7	M20	UCFX17	FX17	UCX17	96.1	71.5	14.5	UCFX17C	UCFX17D	—	—	101	—	10.8	—	
	260	74	204	31	27	44	100	96	40	M27	UCF317	F317	UC317	133	96.8	13.3	—	—	UCF317C	UCF317D	—	117	15.3	16.9	
90	235	68	187	23	25	40	96.3	96	39.7	M20	UCF218	F218	UC218	96.1	71.5	14.5	UCF218C	UCF218D	UCF218FC	UCF218FD	101	116	11.4	12.9	
	214	76	171	23	24	45	106.1	104	42.9	M20	UCFX18	FX18	UCX18	109	81.9	14.4	—	—	UCFX18C	UCFX18D	—	124	11.9	13.6	
	280	76	216	35	30	44	100	96	40	M30	UCF318	F318	UC318	143	107	13.3	—	—	UCF318C	UCF318D	—	119	18.9	20.8	
95	290	94	228	35	30	59	121	103	41	M30	UCF319	F319	UC319	153	119	13.3	—	—	UCF319C	UCF319D	—	140	21.6	23.8	

(Remarks) 1) Applicable sizes of grease nipples are shown below.
 A-1/4-28UNF 201~210, X05~X09, 305~308
 A-PT 1/8 211~218, X10~X20, 309~328

2) For bearings with double- or triple-lip seals, unit and bearing number are suffixed by L2 or L3.
 (UCF206JL3, UC206L3)

3) For more detailed information, refer to ball bearing for unit specification tables.

Ball bearing units
square-flanged type
UCF (with set screws)

d 100 ~ 140 mm

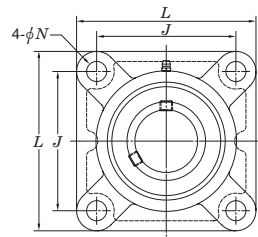
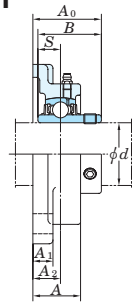

Pressed steel cover

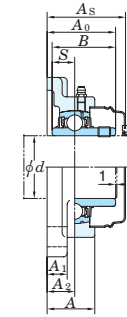

Cast iron cover

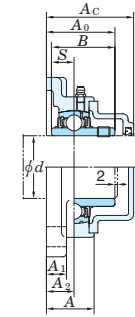

Tolerances for housing

unit : mm

housing No.			ΔA_{2s}	X
F204- F210	FX05- FX10	F305- F310	±0.5	0.7
F211- F218	FX11- FX20	F311- F328	±0.8	1

ΔA_{2s} : deviation of distance from mounting face to centre of spherical bearing seating.

X : positional tolerance of bolt hole.

unit : mm

housing No.			ΔN_s
F204- F218	FX05- FX18	F305- F315	±0.2
	FX20	F316- F328	±0.3

ΔN_s : deviation of bolt hole diameter.

Shaft dia. (mm) <i>d</i>	Dimensions (mm)									Bolt size	Unit No.	Housing No.	Applicable bearing			Unit No. with covers				Cover dimensions (mm)		Unit mass (kg) (Refer.)		
	<i>L</i>	<i>A</i>	<i>J</i>	<i>N</i>	<i>A</i> ₁	<i>A</i> ₂	<i>A</i> ₀	<i>B</i>	<i>S</i>				No.	Basic load ratings (kN)		Factor <i>f</i> ₀	Pressed steel covers		Cast iron covers		<i>A</i> _s	<i>A</i> _c	Pressed steel covers	Cast iron covers
														<i>C</i> _r	<i>C</i> _{0r}		Open ends	Closed end	Open ends	Closed end				
100	268	97	211	31	28	59	127.3	117.5	49.2	M27	UCFX20	FX20	UCX20	133	105	14.4	—	—	UCFX20C	UCFX20D	—	152	19.4	21.6
	310	94	242	38	32	59	125	108	42	M33	UCF320	F320	UC320	173	141	13.2	—	—	UCF320C	UCF320D	—	146	25.8	28.6
105	310	94	242	38	32	59	127	112	44	M33	UCF321	F321	UC321	184	153	13.2	—	—	UCF321C	UCF321D	—	148	30.2	33.2
110	340	96	266	41	35	60	131	117	46	M36	UCF322	F322	UC322	205	180	13.2	—	—	UCF322C	UCF322D	—	154	35.3	41.7
120	370	110	290	41	40	65	140	126	51	M36	UCF324	F324	UC324	207	185	13.5	—	—	UCF324C	UCF324D	—	163	47.3	52.1
130	410	115	320	41	45	65	146	135	54	M36	UCF326	F326	UC326	229	214	13.6	—	—	UCF326C	UCF326D	—	172	65.5	71.6
140	450	125	350	41	55	75	161	145	59	M36	UCF328	F328	UC328	253	246	13.6	—	—	UCF328C	UCF328D	—	186	93.4	101

[Remarks] 1) Applicable sizes of grease nipples are shown below.
 A-1/4-28UNF 201~210, X05~X09, 305~308
 A-PT 1/8 211~218, X10~X20, 309~328

2) For bearings with double- or triple-lip seals, unit and bearing number are suffixed by L2 or L3.
 (UCF206JL3, UC206L3)
 3) For more detailed information, refer to ball bearing for unit specification tables.

**Ball bearing units
square-flanged type with spigot joint
UCFS (with set screws)**

d 25 ~ 105 mm

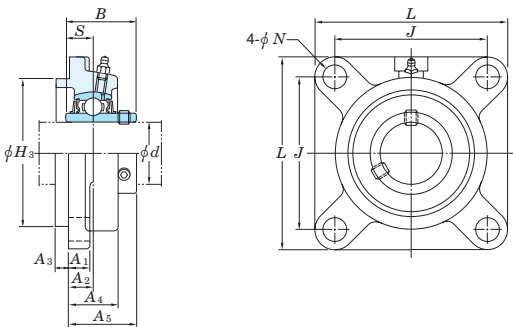

Cast iron cover

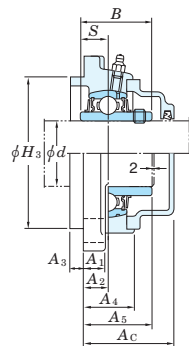

Tolerances for housing

housing No.	unit : mm			
	ΔH_{3s}	ΔA_{2s}	X	Y
FS305	0 -0.046	±0.5	0.7	0.2
FS306- FS308	0 -0.054			
FS309- FS310	0 -0.063			
FS311- FS313	0 -0.072			
FS314- FS319	0 -0.072	±0.8	1	0.3 ~FS318 FS319-
FS320- FS322	0 -0.081			
FS324- FS328	0 -0.089			

unit : mm

housing No.	ΔN_s
FS305-315	±0.2
FS316-328	±0.3

ΔN_s : deviation of bolt hole diameter.
 ΔH_{3s} : deviation of spigot joint outside diameter.
 ΔA_{2s} : deviation of distance from mounting face to centre of spherical bearing seating.
 X : positional tolerance of bolt hole.
 Y : circumferential runout tolerance of spigot joint in respect to axial line of spherical bearing seating.

Shaft dia. (mm) d	Dimensions (mm)											Bolt size	Unit No.	Housing No.	Applicable bearing			Unit No. with covers		Cover dimensions (mm) A _c	(Refer.) Unit mass (kg)	
	L	H ₃	J	N	A ₁	A ₂	A ₃	A ₄	A ₅	B	S				No.	Basic load ratings (kN) C _r C _{0r}	Factor f ₀	Open ends	Closed end		No cover	Cast iron covers
25	110	80	80	16	13	9	7	22	32	38	15	M14	UCFS305	FS305		UC305	21.2 10.9	12.6	UCFS305C UCFS305D	47	1.4	1.7
30	125	90	95	16	15	10	8	24	36	43	17	M14	UCFS306	FS306		UC306	26.7 15.0	13.3	UCFS306C UCFS306D	51	1.9	2.2
35	135	100	100	19	16	11	9	27	40	48	19	M16	UCFS307	FS307		UC307	33.4 19.3	13.2	UCFS307C UCFS307D	55	2.3	2.7
40	150	115	112	19	17	13	10	30	46	52	19	M16	UCFS308	FS308		UC308	40.7 24.0	13.2	UCFS308C UCFS308D	61	3.4	3.9
45	160	125	125	19	18	14	11	33	49	57	22	M16	UCFS309	FS309		UC309	48.9 29.5	13.3	UCFS309C UCFS309D	65	4.4	5.0
50	175	140	132	23	19	16	12	36	55	61	22	M20	UCFS310	FS310		UC310	62.0 38.3	13.2	UCFS310C UCFS310D	71	5.3	6.1
55	185	150	140	23	20	17	13	39	58	66	25	M20	UCFS311	FS311		UC311	71.6 45.0	13.2	UCFS311C UCFS311D	74	6.1	7.0
60	195	160	150	23	22	19	14	42	64	71	26	M20	UCFS312	FS312		UC312	81.9 52.2	13.2	UCFS312C UCFS312D	81	7.4	8.6
65	208	175	166	23	22	15	18	40	60	75	30	M20	UCFS313	FS313		UC313	92.7 59.9	13.2	UCFS313C UCFS313D	76	8.8	9.9
70	226	185	178	25	25	18	18	43	63	78	33	M22	UCFS314	FS314		UC314	104 68.2	13.2	UCFS314C UCFS314D	80	11.2	12.3
75	236	200	184	25	25	21	18	48	71	82	32	M22	UCFS315	FS315		UC315	113 77.2	13.2	UCFS315C UCFS315D	88	13.7	15.0
80	250	210	196	31	27	18	20	48	70	86	34	M27	UCFS316	FS316		UC316	123 86.7	13.3	UCFS316C UCFS316D	87	15.1	16.5
85	260	220	204	31	27	24	20	54	80	96	40	M27	UCFS317	FS317		UC317	133 96.8	13.3	UCFS317C UCFS317D	97	17.3	18.9
90	280	240	216	35	30	24	20	56	80	96	40	M30	UCFS318	FS318		UC318	143 107	13.3	UCFS318C UCFS318D	99	21.3	23.2
95	290	250	228	35	30	39	20	74	101	103	41	M30	UCFS319	FS319		UC319	153 119	13.3	UCFS319C UCFS319D	120	24.5	26.7
100	310	260	242	38	32	39	20	74	105	108	42	M33	UCFS320	FS320		UC320	173 141	13.2	UCFS320C UCFS320D	126	29.5	32.3
105	310	260	242	38	32	39	20	74	107	112	44	M33	UCFS321	FS321		UC321	184 153	13.2	UCFS321C UCFS321D	128	32.7	35.7

[Remarks] 1) Applicable sizes of grease nipples are shown below.
 A-1/4-28UNF 305~308
 A-PT 1/8 309~328

2) Bearings with triple-lip seals are indicated by L3 after the bearing and unit number.
 (UCFS307JL3, UC307L3)
 3) For more detailed information, refer to ball bearing for unit specification tables.

Ball bearing units
square-flanged type with spigot joint
UCFS (with set screws)

d 110 ~ 140 mm

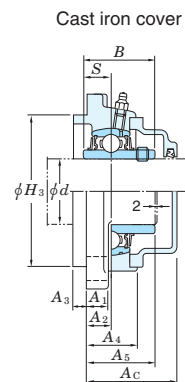
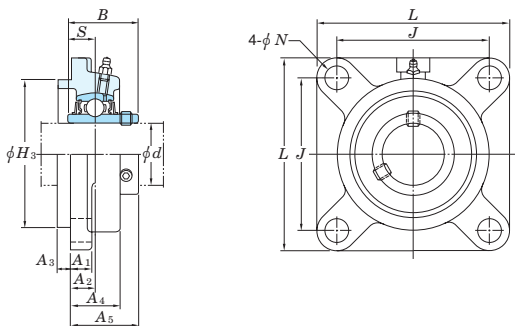

Tolerances for housing

housing No.	ΔH_{3s}	ΔA_{2s}	unit : mm	
			X	Y
FS305	0 -0.046	±0.5	0.7	0.2
FS306- FS308	0 -0.054			
FS309- FS310	0 -0.063			
FS311- FS313	0 -0.072	±0.8	1	0.3 ~FS318 FS319~
FS314- FS319	0 -0.081			
FS320- FS322	0 -0.089			
FS324- FS328	0 -0.089			0.4

unit : mm	
housing No.	ΔN_s
FS305-315	±0.2
FS316-328	±0.3

ΔN_s : deviation of bolt hole diameter.

ΔH_{3s} : deviation of spigot joint outside diameter.
 ΔA_{2s} : deviation of distance from mounting face to centre of spherical bearing seating.
 X : positional tolerance of bolt hole.
 Y : circumferential runout tolerance of spigot joint in respect to axial line of spherical bearing seating.

Shaft dia. (mm)	Dimensions (mm)											Bolt size	Unit No.	Housing No.	Applicable bearing			Unit No. with covers		Cover dimensions (mm) A_c	(Refer.) Unit mass (kg)		
	d	L	H_3	J	N	A_1	A_2	A_3	A_4	A_5	B				S	No.	Basic load ratings (kN) C_r C_{0r}	Factor f_0	Open ends		Closed end	No cover	Cast iron covers
110	340	300	266	41	35	35	25	71	106	117	46	M36	UCFS322	FS322		UC322	205 180	13.2	UCFS322C	UCFS322D	129	39.0	42.4
120	370	330	290	41	40	35	30	80	110	126	51	M36	UCFS324	FS324		UC324	207 185	13.5	UCFS324C	UCFS324D	133	50.6	55.4
130	410	360	320	41	45	35	30	85	116	135	54	M36	UCFS326	FS326		UC326	229 214	13.6	UCFS326C	UCFS326D	142	67.7	73.8
140	450	400	350	41	55	45	30	95	131	145	59	M36	UCFS328	FS328		UC328	253 246	13.6	UCFS328C	UCFS328D	156	94.0	102

[Remarks] 1) Applicable sizes of grease nipples are shown below.
 A-1/4-28UNF 305~308
 A-PT 1/8 309~328

2) Bearings with triple-lip seals are indicated by L3 after the bearing and unit number.
 (UCFS307JL3, UC307L3)
 3) For more detailed information, refer to ball bearing for unit specification tables.

Ball bearing units rhombic-flanged type UCFL (with set screws)

d 12 ~ 55 mm

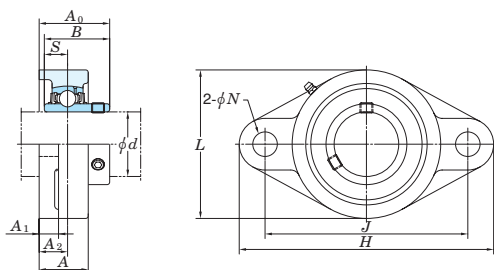

Pressed steel cover

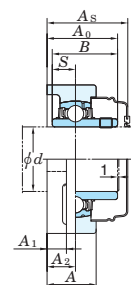

Cast iron cover

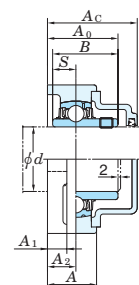

Tolerances for housing

housing No.			ΔN_s	housing No.			ΔA_{2s}	X
unit : mm				unit : mm				
FL204- FL216	FLX05- FLX10	FL305- FL311	± 0.2	FL204- FL210	FLX05- FLX10	FL305- FL310	± 0.5	0.7
	FL312- FL328		± 0.3	FL211- FL218		FL311- FL328	± 0.8	1

ΔN_s : deviation of bolt hole diameter.

ΔA_{2s} : deviation of distance from mounting face to centre of spherical bearing seating.

FL204JE3, FL205JE3 (with cast iron covers) are shown below.

FL204JE3 $L_c = 65$ mm
FL205JE3 $L_c = 73$ mm



X : positional tolerance of bolt hole.

Shaft dia. (mm) d	Dimensions (mm)											Bolt size	Unit No.	Housing No.	Applicable bearing			Unit No. with covers				Cover dimensions (mm)		(Refer.) Unit mass (kg)		
	H	L	A	J	N	A_1	A_2	A_0	B	S	No.				Basic load ratings (kN) C_r	C_{0r}	Factor f_0	Pressed steel covers		Cast iron covers		A_s	A_c	Pressed steel covers	Cast iron covers	
	Open ends	Closed end	Open ends	Closed end																						
12	113	60	25.5	90	12	11	15	33.3	31	12.7	M10	UCFL201	FL204		UC201	12.8	6.65	13.2	UCFL201C	UCFL201D	—	—	37	—	0.50	—
15	113	60	25.5	90	12	11	15	33.3	31	12.7	M10	UCFL202	FL204		UC202	12.8	6.65	13.2	UCFL202C	UCFL202D	—	—	37	—	0.48	—
17	113	60	25.5	90	12	11	15	33.3	31	12.7	M10	UCFL203	FL204		UC203	12.8	6.65	13.2	UCFL203C	UCFL203D	—	—	37	—	0.47	—
20	113	60	25.5	90	12	11	15	33.3	31	12.7	M10	UCFL204	FL204		UC204	12.8	6.65	13.2	UCFL204C	UCFL204D	UCFL204FC	UCFL204FD	37	46	0.45	0.60
25	130	68	27	99	16	13	16	35.8	34.1	14.3	M14	UCFL205	FL205		UC205	14.0	7.85	13.9	UCFL205C	UCFL205D	UCFL205FC	UCFL205FD	40	49	0.64	0.83
	141	83	30	117	12	13	18	40.2	38.1	15.9	M10	UCFLX05	FLX05		UCX05	19.5	11.3	13.9	UCFLX05C	UCFLX05D	—	—	44	—	1.1	—
	150	80	29	113	19	13	16	39	38	15	M16	UCFL305	FL305		UC305	21.2	10.9	12.6	—	—	UCFL305C	UCFL305D	—	54	1.1	1.4
30	148	80	31	117	16	13	18	40.2	38.1	15.9	M14	UCFL206	FL206		UC206	19.5	11.3	13.9	UCFL206C	UCFL206D	UCFL206FC	UCFL206FD	44	53	0.93	1.2
	156	95	34	130	16	14	19	44.4	42.9	17.5	M14	UCFLX06	FLX06		UCX06	25.7	15.4	13.9	UCFLX06C	UCFLX06D	—	—	49	—	1.5	—
	180	90	32	134	23	15	18	44	43	17	M20	UCFL306	FL306		UC306	26.7	15.0	13.3	—	—	UCFL306C	UCFL306D	—	59	1.5	1.8
35	161	90	34	130	16	14	19	44.4	42.9	17.5	M14	UCFL207	FL207		UC207	25.7	15.4	13.9	UCFL207C	UCFL207D	UCFL207FC	UCFL207FD	49	58	1.2	1.6
	171	105	38	144	16	14	21	51.2	49.2	19	M14	UCFLX07	FLX07		UCX07	29.1	17.8	14.0	UCFLX07C	UCFLX07D	—	—	55	—	1.9	—
	185	100	36	141	23	16	20	49	48	19	M20	UCFL307	FL307		UC307	33.4	19.3	13.2	—	—	UCFL307C	UCFL307D	—	64	1.8	2.2
40	175	100	36	144	16	14	21	51.2	49.2	19	M14	UCFL208	FL208		UC208	29.1	17.8	14.0	UCFL208C	UCFL208D	UCFL208FC	UCFL208FD	55	64	1.6	2.0
	179	111	40	148	16	14	22	52.2	49.2	19	M14	UCFLX08	FLX08		UCX08	32.7	20.3	14.0	UCFLX08C	UCFLX08D	—	—	56	—	2.1	—
	200	112	40	158	23	17	23	56	52	19	M20	UCFL308	FL308		UC308	40.7	24.0	13.2	—	—	UCFL308C	UCFL308D	—	71	2.5	3.0
45	188	108	38	148	19	15	22	52.2	49.2	19	M16	UCFL209	FL209		UC209	32.7	20.3	14.0	UCFL209C	UCFL209D	UCFL209FC	UCFL209FD	56	66	1.9	2.3
	189	116	40	157	16	14	23	55.6	51.6	19	M14	UCFLX09	FLX09		UCX09	35.1	23.3	14.4	UCFLX09C	UCFLX09D	—	—	60	—	2.4	—
	230	125	44	177	25	18	25	60	57	22	M22	UCFL309	FL309		UC309	48.9	29.5	13.3	—	—	UCFL309C	UCFL309D	—	76	3.5	4.1
50	197	115	40	157	19	15	22	54.6	51.6	19	M16	UCFL210	FL210		UC210	35.1	23.3	14.4	UCFL210C	UCFL210D	UCFL210FC	UCFL210FD	59	70.5	2.2	2.7
	216	133	44	184	19	20	26	59.4	55.6	22.2	M16	UCFLX10	FLX10		UCX10	43.4	29.4	14.4	UCFLX10C	UCFLX10D	—	—	64	—	3.8	—
	240	140	48	187	25	19	28	67	61	22	M22	UCFL310	FL310		UC310	62.0	38.3	13.2	—	—	UCFL310C	UCFL310D	—	83	4.4	5.2
55	224	130	43	184	19	18	25	58.4	55.6	22.2	M16	UCFL211	FL211		UC211	43.4	29.4	14.4	UCFL211C	UCFL211D	UCFL211FC	UCFL211FD	63	74.5	3.3	3.9
	250	150	52	198	25	20	30	71	66	25	M22	UCFL311	FL311		UC311	71.6	45.0	13.2	—	—	UCFL311C	UCFL311D	—	87	5.3	6.2

(Remarks) 1) Applicable sizes of grease nipples are shown below.

A-1/4-28UNF 201~210, X05~X09, 305~308

A-PT 1/8 211~217, X10~X17, 309~328

2) Bearings with triple-lip seals are indicated by L3 after the bearing and unit number.

(UCFS307JL3, UC307L3)

3) For more detailed information, refer to ball bearing for unit specification tables.

Ball bearing units rhombic-flanged type UCFL (with set screws)

d 60 ~ 140 mm

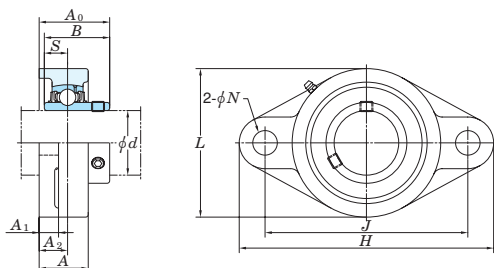

Pressed steel cover

Cast iron cover

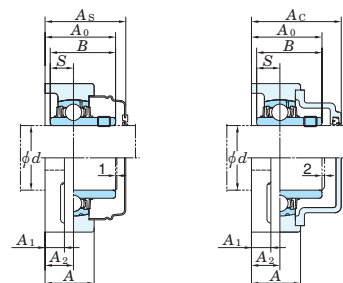

Tolerances for housing

unit : mm

unit : mm

housing No.	ΔN_s
FL204-FL216	± 0.2
FLX05-FLX10	± 0.3
FL305-FL311	
FL312-FL328	

housing No.	ΔA_{2s}	X
FL204-FL210	± 0.5	0.7
FLX05-FLX10		
FL305-FL310		
FL211-FL216	± 0.8	1
FL311-FL328		

ΔN_s : deviation of bolt hole diameter.

ΔA_{2s} : deviation of distance from mounting face to centre of spherical bearing seating.

X : positional tolerance of bolt hole.

Shaft dia. (mm) d	Dimensions (mm)											Bolt size	Unit No.	Housing No.	Applicable bearing			Unit No. with covers				Cover dimensions (mm)		(Refer.) Unit mass (kg)	
	H	L	A	J	N	A ₁	A ₂	A ₀	B	S	No.				Basic load ratings (kN) <i>C_r</i> <i>C_{0r}</i>	Factor <i>f₀</i>	Pressed steel covers Open ends Closed end		Cast iron covers Open ends Closed end		<i>A_s</i>	<i>A_c</i>	Pressed steel covers	Cast iron covers	
60	250	140	48	202	23	18	29	68.7	65.1	25.4	M20	UCFL212 UCFL312	FL212 FL312		UC212 UC312	52.4 36.2 81.9 52.2	14.4 13.2	UCFL212C	UCFL212D	UCFL212FC	UCFL212FD	73	86	4.2	5.0
	270	160	56	212	31	22	33	78	71	26	M27							—	—	UCFL312C	UCFL312D	—	95	6.5	7.7
65	258	155	50	210	23	20	30	69.7	65.1	25.4	M20	UCFL213 UCFL313	FL213 FL313		UC213 UC313	57.2 40.1 92.7 59.9	14.4 13.2	UCFL213C	UCFL213D	UCFL213FC	UCFL213FD	74	87	5.1	5.9
	295	175	58	240	31	25	33	78	75	30	M27							—	—	UCFL313C	UCFL313D	—	94	8.5	9.6
70	265	160	54	216	23	20	31	75.4	74.6	30.2	M20	UCFL214 UCFL314	FL214 FL314		UC214 UC314	62.2 44.1 104 68.2	14.5 13.2	UCFL214C	UCFL214D	UCFL214FC	UCFL214FD	80	93	5.7	6.6
	315	185	61	250	35	28	36	81	78	33	M30							—	—	UCFL314C	UCFL314D	—	98	9.7	10.8
75	275	165	56	225	23	20	34	78.5	77.8	33.3	M20	UCFL215 UCFL315	FL215 FL315		UC215 UC315	67.4 48.3 113 77.2	14.5 13.2	UCFL215C	UCFL215D	UCFL215FC	UCFL215FD	83	96	6.4	7.4
	320	195	66	260	35	30	39	89	82	32	M30							—	—	UCFL315C	UCFL315D	—	106	11.3	12.6
80	290	180	58	233	25	20	34	83.3	82.6	33.3	M22	UCFL216 UCFL316	FL216 FL316		UC216 UC316	72.7 53.0 123 86.7	14.6 13.3	UCFL216C	UCFL216D	UCFL216FC	UCFL216FD	88	103	7.8	9.0
	355	210	68	285	38	32	38	90	86	34	M33							—	—	UCFL316C	UCFL316D	—	107	14.4	15.8
85	305	190	63	248	25	22	36	87.6	85.7	34.1	M22	UCFL217 UCFL317	FL217 FL317		UC217 UC317	84.0 61.9 133 96.8	14.5 13.3	UCFL217C	UCFL217D	UCFL217FC	UCFL217FD	92	107	9.8	11.2
	370	220	74	300	38	32	44	100	96	40	M33							—	—	UCFL317C	UCFL317D	—	117	16.0	17.6
90	320	205	68	265	25	23	40	96.3	96	39.7	M22	UCFL218 UCFL318	FL218 FL318		UC218 UC318	96.1 71.5 143 107	14.5 13.3	UCFL218C	UCFL218D	UCFL218FC	UCFL218FD	101	116	12.3	13.8
	385	235	76	315	38	36	44	100	96	40	M33							—	—	UCFL318C	UCFL318D	—	119	19.0	20.9
95	405	250	94	330	41	40	59	121	103	41	M36	UCFL319	FL319		UC319	153 119	13.3	—	—	UCFL319C	UCFL319D	—	140	24.6	26.8
100	440	270	94	360	44	40	59	125	108	42	M39	UCFL320	FL320		UC320	173 141	13.2	—	—	UCFL320C	UCFL320D	—	146	29.4	32.2
105	440	270	94	360	44	40	59	127	112	44	M39	UCFL321	FL321		UC321	184 153	13.2	—	—	UCFL321C	UCFL321D	—	148	34.4	37.4
110	470	300	96	390	44	42	60	131	117	46	M39	UCFL322	FL322		UC322	205 180	13.2	—	—	UCFL322C	UCFL322D	—	154	36.2	39.6
120	520	330	110	430	47	48	65	140	126	51	M42	UCFL324	FL324		UC324	207 185	13.5	—	—	UCFL324C	UCFL324D	—	163	51.6	56.4
130	550	360	115	460	47	50	65	146	135	54	M42	UCFL326	FL326		UC326	229 214	13.6	—	—	UCFL326C	UCFL326D	—	172	61.6	67.7
140	600	400	125	500	51	60	75	161	145	59	M45	UCFL328	FL328		UC328	253 246	13.6	—	—	UCFL328C	UCFL328D	—	186	68.4	76.1

(Remarks) 1) Applicable sizes of grease nipples are shown below.
A-1/4-28UNF 201~210, X05~X09, 305~308
A-PT 1/8 211~217, X10~X17, 309~328

2) Bearings with triple-lip seals are indicated by L3 after the bearing and unit number.
(UCFS307JL3, UC307L3)
3) For more detailed information, refer to ball bearing for unit specification tables.

Ball bearing units
light duty rhombic-flanged type
BLF (with set screws)

d 12 ~ 35 mm

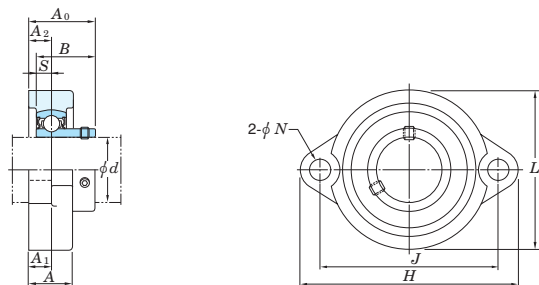

Shaft dia. (mm) <i>d</i>	Dimensions (mm)										Bolt size	Unit No.	Housing No.	No.	Applicable bearing		Factor <i>f</i> ₀	(Refer.) Unit mass (kg)
	<i>H</i>	<i>L</i>	<i>A</i>	<i>J</i> ±0.7	<i>N</i> ±0.2	<i>A</i> ₁	<i>A</i> ₂ ±0.5	<i>A</i> ₀	<i>B</i>	<i>S</i>					<i>C</i> _r	<i>C</i> _{0r}		
12	81	52	18	63.5	8	9.5	9.5	25.5	22	6	M6	BLF201	LF203	SB201	9.55	4.80	13.2	0.25
15	81	52	18	63.5	8	9.5	9.5	25.5	22	6	M6	BLF202	LF203	SB202	9.55	4.80	13.2	0.25
17	81	52	18	63.5	8	9.5	9.5	25.5	22	6	M6	BLF203	LF203	SB203	9.55	4.80	13.2	0.25
20	90	60	20	71.5	10	11	11	29	25	7	M8	BLF204	LF204	SB204	12.8	6.65	13.2	0.33
25	95	64	20	76	10	11	11	30.5	27	7.5	M8	BLF205	LF205	SB205	14.0	7.85	13.9	0.38
30	113	76	22.5	90.5	12	12	12	34	30	8	M10	BLF206	LF206	SB206	19.5	11.3	13.9	0.57
35	122	89	24	100	12	13	13	36.5	32	8.5	M10	BLF207	LF207	SB207	25.7	15.4	13.9	0.77

[Remarks] 1) The radial loading on housing should not exceed 50% of the basic load rating (*C*_r).
 2) For more detailed information, refer to ball bearing for unit specification tables.

Ball bearing units
“compact” series rhombic-flanged type

UFL (with set screws)

d 8 ~ 30 mm

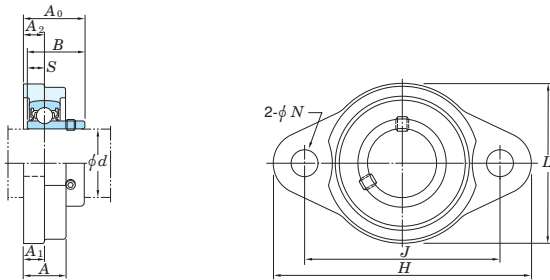

Open ends type

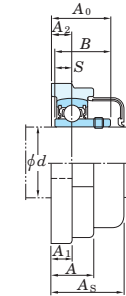

Closed end type

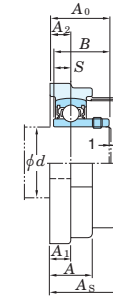

Tolerance for housing

unit : mm	
housing No.	X
FL000-FL006	0.6

X : positional tolerance of bolt hole.

Shaft dia. (mm) <i>d</i>	Dimensions (mm)											Bolt size	Unit No.	Housing No.	No.	Applicable bearing			Unit No. with covers		Cover dimension (mm) <i>A_s</i>	(Refer.) Unit mass (kg)
	<i>H</i>	<i>L</i>	<i>A</i>	<i>J</i>	<i>N</i> ±0.2		<i>A₁</i>	<i>A₂</i> ±0.5		<i>B</i>	<i>S</i>					Basic load ratings (kN)		Factor <i>f₀</i>	Open ends	Closed end		
					<i>C_r</i>	<i>C_{0r}</i>																
8	48	27	8.5	37	4.8	4	4	12.5	12	3.5	M4	UFL08	FL08	SU08	3.27	1.37	12.4	—	—	—	0.030	
10	60	36	12	45	7	6	6	16	15	5	M6	UFL000	FL000	SU000	4.55	1.95	12.3	UFL000C	UFL000D	20.5	0.050	
12	63	38	12	48	7	6	6	16	15	5	M6	UFL001	FL001	SU001	5.10	2.40	13.2	UFL001C	UFL001D	20.5	0.065	
15	67	42	13	53	7	6.5	6.5	17.5	16.5	5.5	M6	UFL002	FL002	SU002	5.60	2.85	13.9	UFL002C	UFL002D	22	0.085	
17	71	46	14	56	7	7	7	18.5	17.5	6	M6	UFL003	FL003	SU003	6.00	3.25	14.4	UFL003C	UFL003D	23.5	0.11	
20	90	55	16	71	10	8	8	22	21	7	M8	UFL004	FL004	SU004	9.40	5.05	13.9	UFL004C	UFL004D	27	0.18	
25	95	60	16	75	10	8	8	23	22	7	M8	UFL005	FL005	SU005	10.1	5.85	14.5	UFL005C	UFL005D	28	0.23	
30	112	70	18	85	13	9	9	26	24.5	7.5	M10	UFL006	FL006	SU006	13.2	8.25	14.7	UFL006C	UFL006D	31	0.31	

[Remarks] 1) Housing is made from special light alloy.
 2) For more detailed information, refer to ball bearing for unit specification tables.

Ball bearing units
stainless-series rhombic-flanged type
UCSFL-H1S6 (with set screws)

d 12 ~ 50 mm

Tolerance for housing

unit : mm

housing No.	X
SFL203 H1-210 H1	0.7

X : positional tolerance of bolt hole.

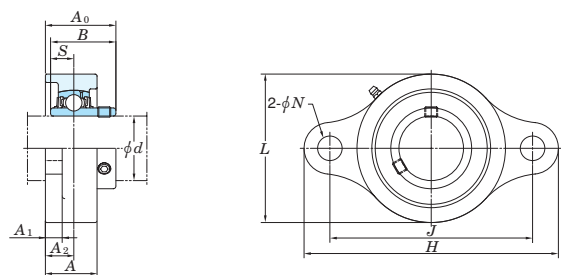

Pressed stainless steel covers

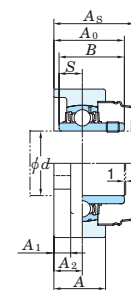

Shaft dia. (mm) <i>d</i>	Dimensions (mm)											Bolt size	Unit No.	Housing No.	No.	Applicable bearing			Unit No. with covers		Cover dimension (mm) <i>A_s</i>	(Refer.) Unit mass (kg) Pressed steel covers
	<i>H</i>	<i>L</i>	<i>A</i>	<i>J</i>	<i>N</i> ±0.2	<i>A₁</i>	<i>A₂</i> ±0.5	<i>A₀</i>	<i>B</i>	<i>S</i>	<i>C_r</i>					<i>C_{0r}</i>	Factor <i>f₀</i>	Open ends	Closed end			
12	98	54	24	76.5	12	10	14	29.9	27.4	11.5	M10	UCSFL201XH1S6	SFL203H1		UC201XS6	8.15	3.85	13.2	—	—	—	0.31
15	98	54	24	76.5	12	10	14	29.9	27.4	11.5	M10	UCSFL202XH1S6	SFL203H1		UC202XS6	8.15	3.85	13.2	—	—	—	0.31
17	98	54	24	76.5	12	10	14	29.9	27.4	11.5	M10	UCSFL203XH1S6	SFL203H1		UC203XS6	8.15	3.85	13.2	—	—	—	0.31
20	113	60	26	90	12	10	15	33.3	31	12.7	M10	UCSFL204H1S6	SFL204H1		UC204S6	10.9	5.35	13.2	UCSFL204H1CS6	UCSFL204H1DS6	38	0.43
25	130	68	27.5	99	16	10	16	35.8	34.1	14.3	M14	UCSFL205H1S6	SFL205H1		UC205S6	11.9	6.30	13.9	UCSFL205H1CS6	UCSFL205H1DS6	40	0.60
30	148	80	31	117	16	10	18	40.2	38.1	15.9	M14	UCSFL206H1S6	SFL206H1		UC206S6	16.5	9.05	13.9	UCSFL206H1CS6	UCSFL206H1DS6	45	0.86
35	161	90	34	130	16	11	19	44.4	42.9	17.5	M14	UCSFL207H1S6	SFL207H1		UC207S6	21.8	12.3	13.9	UCSFL207H1CS6	UCSFL207H1DS6	49	1.1
40	175	100	36	144	16	12	21	51.2	49.2	19	M14	UCSFL208H1S6	SFL208H1		UC208S6	24.8	14.3	14.0	UCSFL208H1CS6	UCSFL208H1DS6	56	1.5
45	188	108	38	148	19	13	22	52.2	49.2	19	M16	UCSFL209H1S6	SFL209H1		UC209S6	27.8	16.2	14.0	UCSFL209H1CS6	UCSFL209H1DS6	57	1.8
50	197	115	40	157	19	13	22	54.6	51.6	19	M16	UCSFL210H1S6	SFL210H1		UC210S6	29.8	18.6	14.4	UCSFL210H1CS6	UCSFL210H1DS6	59	2.1

[Remarks] 1) Applicable size of grease nipples is A-1/4-28UNF.

2) For more detailed information, refer to ball bearing for unit specification tables.

Ball bearing units round-flanged type with spigot joint UCFC (with set screws)

d 12 ~ 65 mm

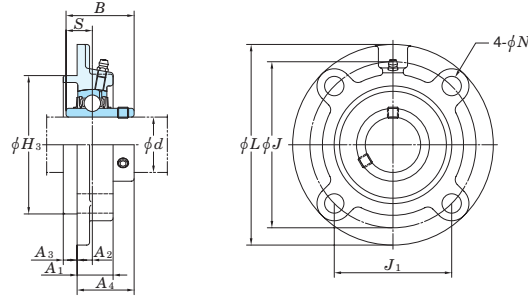

Pressed steel cover Cast iron cover

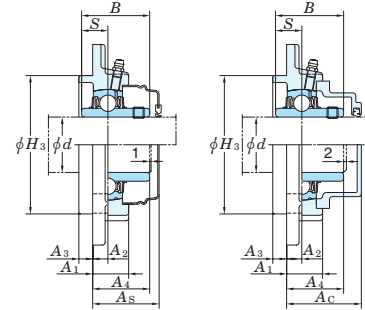

Tolerances for housing

unit : mm					
housing No.	ΔH_{3s}	ΔA_{2s}	X	Y	
FC204-FC206	FCX05	0 -0.046	± 0.5	0.7	0.2
FC207-FC210	FCX06-FCX10	0 -0.054			
FC211-FC217	FCX11-FCX15	0 -0.063	± 0.8	1	0.3
FC218	FCX16-FCX18	0 -0.072			
	FCX20				0.4

ΔH_{3s} : deviation of spigot joint outside diameter.
 ΔA_{2s} : deviation of distance from mounting face to centre of spherical bearing seating.
 X : positional tolerance of bolt hole.
 Y : circumferential runout tolerance of spigot joint in respect to axial line of spherical bearing seating.

Shaft dia. (mm)	Dimensions (mm)												Bolt size	Unit No.	Housing No.	Applicable bearing			Unit No. with covers				Cover dimensions (mm)		(Refer.) Unit Mass (kg)		
	d	L	H_3	J	J_1	$N_{\pm 0.2}$	A ₁	A ₂	A ₃	A ₄	B	S				No.	Basic load ratings (kN)		Factor f_0	Pressed steel covers		Cast iron covers		A _s	A _c	Pressed steel covers	Cast iron covers
																	C_r	C_{0r}		Open ends	Closed end	Open ends	Closed end				
12	100	62	78	55.1	12	20.5	10	5	28.3	31	12.7	M10	UCFC201	FC204	UC201	12.8	6.65	13.2	UCFC201C	UCFC201D	—	—	32	—	0.78	—	
	15	100	62	78	55.1	12	20.5	10	5	28.3	31	12.7							M10	UCFC202	FC204	UC202	12.8	6.65	13.2	UCFC202C	UCFC202D
17	100	62	78	55.1	12	20.5	10	5	28.3	31	12.7	M10	UCFC203	FC204	UC203	12.8	6.65	13.2	UCFC203C	UCFC203D	—	—	32	—	0.75	—	
	20	100	62	78	55.1	12	20.5	10	5	28.3	31	12.7							M10	UCFC204	FC204	UC204	12.8	6.65	13.2	UCFC204C	UCFC204D
25	115	70	90	63.6	12	21	10	6	29.8	34.1	14.3	M10	UCFC205	FC205	UC205	14.0	7.85	13.9	UCFC205C	UCFC205D	UCFC205FC	UCFC205FD	34	42	0.95	1.1	
	111	76	92	65	9.5	24	10	6	32.2	38.1	15.9	M8							UCFCX05	FCX05	UCX05	19.5	11.3	13.9	UCFCX05C	UCFCX05D	—
30	125	80	100	70.7	12	23	10	8	32.2	38.1	15.9	M10	UCFC206	FC206	UC206	19.5	11.3	13.9	UCFC206C	UCFC206D	UCFC206FC	UCFC206FD	36	45	1.3	1.6	
	127	85	105	74.2	12	22.5	8	9.5	33.4	42.9	17.5	M10							UCFCX06	FCX06	UCX06	25.7	15.4	13.9	UCFCX06C	UCFCX06D	—
35	135	90	110	77.8	14	26	11	8	36.4	42.9	17.5	M12	UCFC207	FC207	UC207	25.7	15.4	13.9	UCFC207C	UCFC207D	UCFC207FC	UCFC207FD	41	50	1.7	2.1	
	133	92	111	78.5	12	26	9	11	39.2	49.2	19	M10							UCFCX07	FCX07	UCX07	29.1	17.8	14.0	UCFCX07C	UCFCX07D	—
40	145	100	120	84.8	14	26	11	10	41.2	49.2	19	M12	UCFC208	FC208	UC208	29.1	17.8	14.0	UCFC208C	UCFC208D	UCFC208FC	UCFC208FD	45	54	2.0	2.4	
	133	92	111	78.5	12	26	9	11	39.2	49.2	19	M10							UCFCX08	FCX08	UCX08	32.7	20.3	14.0	UCFCX08C	UCFCX08D	—
45	160	105	132	93.3	16	26	10	12	40.2	49.2	19	M14	UCFC209	FC209	UC209	32.7	20.3	14.0	UCFC209C	UCFC209D	UCFC209FC	UCFC209FD	44	54	2.6	3.0	
	155	108	130	91.9	14	25	8	12	40.6	51.6	19	M12							UCFCX09	FCX09	UCX09	35.1	23.3	14.4	UCFCX09C	UCFCX09D	—
50	165	110	138	97.6	16	28	10	12	42.6	51.6	19	M14	UCFC210	FC210	UC210	35.1	23.3	14.4	UCFC210C	UCFC210D	UCFC210FC	UCFC210FD	47	58.5	2.9	3.4	
	162	118	136	96.2	14	25	7	16	40.4	55.6	22.2	M12							UCFCX10	FCX10	UCX10	43.4	29.4	14.4	UCFCX10C	UCFCX10D	—
55	185	125	150	106.1	19	31	13	12	46.4	55.6	22.2	M16	UCFC211	FC211	UC211	43.4	29.4	14.4	UCFC211C	UCFC211D	UCFC211FC	UCFC211FD	51	62.5	4.2	4.8	
	180	127	152	107.5	16	26	4	22	43.7	65.1	25.4	M14							UCFCX11	FCX11	UCX11	52.4	36.2	14.4	UCFCX11C	UCFCX11D	—
60	195	135	160	113.1	19	36	17	12	56.7	65.1	25.4	M16	UCFC212	FC212	UC212	52.4	36.2	14.4	UCFC212C	UCFC212D	UCFC212FC	UCFC212FD	61	74	5.0	5.8	
	194	140	165	116.7	16	33	11	20	50.7	65.1	25.4	M14							UCFCX12	FCX12	UCX12	57.2	40.1	14.4	UCFCX12C	UCFCX12D	—
65	205	145	170	120.2	19	36	16	14	55.7	65.1	25.4	M16	UCFC213	FC213	UC213	57.2	40.1	14.4	UCFC213C	UCFC213D	UCFC213FC	UCFC213FD	60	73	5.6	6.4	
	194	140	165	116.7	16	33	11	20	55.4	74.6	30.2	M14							UCFCX13	FCX13	UCX13	62.2	44.1	14.5	UCFCX13C	UCFCX13D	—

[Remarks] 1) Applicable sizes of grease nipples are shown below.
 A-1/4-28UNF..... 201~210, X05~X09
 A-PT 1/8..... 211~218, X10~X20

2) For bearings with double- or triple-lip seals, unit and bearing number are suffixed by L2 or L3.
 (UCFC206JL3, UC206L3)
 3) For more detailed information, refer to ball bearing for unit specification tables.

Ball bearing units
round-flanged type with spigot joint
UCFC (with set screws)

d 70 ~ 100 mm

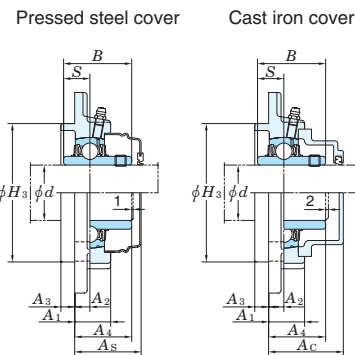
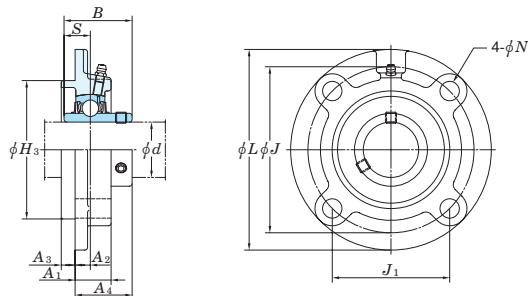

Tolerances for housing

unit : mm

housing No.	ΔH_{3s}	ΔA_{2s}	X	Y
FC204-FC206	0 -0.046	±0.5	0.7	0.2
FC207-FC210	0 -0.054			
FC211-FC217	0 -0.063	±0.8	1	0.3
FC218	0 -0.072			
FCX20				0.4

ΔH_{3s} : deviation of spigot joint outside diameter.
 ΔA_{2s} : deviation of distance from mounting face to centre of spherical bearing seating.
 X : positional tolerance of bolt hole.
 Y : circumferential runout tolerance of spigot joint in respect to axial line of spherical bearing seating.

Shaft dia. (mm) <i>d</i>	Dimensions (mm)												Bolt size	Unit No.	Housing No.	Applicable bearing			Unit No. with covers				Cover dimensions (mm)		Unit Mass (kg)		
	<i>L</i>	<i>H</i> ₃	<i>J</i>	<i>J</i> ₁	<i>N</i> ±0.2	<i>A</i> ₁	<i>A</i> ₂	<i>A</i> ₃	<i>A</i> ₄	<i>B</i>	<i>S</i>	No.				Basic load ratings (kN)		Factor		Pressed steel covers		Cast iron covers		<i>A</i> _s	<i>A</i> _c	Pressed steel covers	Cast iron covers
	<i>C</i> _r	<i>C</i> _{0r}	<i>f</i> ₀	Open ends	Closed end	Open ends	Closed end																				
70	215	150	177	125.1	19	40	17	14	61.4	74.6	30.2	M16	UCFC214	FC214		UC214	62.2	44.1	14.5	UCFC214C	UCFC214D	UCFC214FC	UCFC214FD	66	79	6.8	7.7
	222	164	190	134.3	19	36	14	20	58.5	77.8	33.3	M16	UCFCX14	FCX14		UCX14	67.4	48.3	14.5	UCFCX14C	UCFCX14D	—	—	63	—	7.3	—
75	220	160	184	130.1	19	40	18	16	62.5	77.8	33.3	M16	UCFC215	FC215		UC215	67.4	48.3	14.5	UCFC215C	UCFC215D	UCFC215FC	UCFC215FD	67	80	7.2	8.2
	222	164	190	134.3	19	35	12	22	61.3	82.6	33.3	M16	UCFCX15	FCX15		UCX15	72.7	53.0	14.6	UCFCX15C	UCFCX15D	—	—	66	—	8.0	—
80	240	170	200	141.4	23	42	18	16	67.3	82.6	33.3	M20	UCFC216	FC216		UC216	72.7	53.0	14.6	UCFC216C	UCFC216D	UCFC216FC	UCFC216FD	72	87	8.7	9.9
	260	186	219	154.8	23	36	10	25	61.6	85.7	34.1	M20	UCFCX16	FCX16		UCX16	84.0	61.9	14.5	UCFCX16C	UCFCX16D	—	—	66	—	11.3	—
85	250	180	208	147.1	23	45	18	18	69.6	85.7	34.1	M20	UCFC217	FC217		UC217	84.0	61.9	14.5	UCFC217C	UCFC217D	UCFC217FC	UCFC217FD	74	89	10.3	11.7
	260	186	219	154.8	23	36	10	25	66.3	96	39.7	M20	UCFCX17	FCX17		UCX17	96.1	71.5	14.5	UCFCX17C	UCFCX17D	—	—	71	—	12.9	—
90	265	190	220	155.5	23	50	22	18	78.3	96	39.7	M20	UCFC218	FC218		UC218	96.1	71.5	14.5	UCFC218C	UCFC218D	UCFC218FC	UCFC218FD	83	98	13.3	14.8
	260	186	219	154.8	23	43	12	28	73.1	104	42.9	M20	UCFCX18	FCX18		UCX18	109	81.9	14.4	—	—	UCFCX18C	UCFCX18D	—	92	13.5	15.4
100	276	206	238	168.3	23	66	22	28	90.3	117.5	49.2	M20	UCFCX20	FCX20		UCX20	133	105	14.4	—	—	UCFCX20C	UCFCX20D	—	116	18.2	20.7

[Remarks] 1) Applicable sizes of grease nipples are shown below.
 A-1/4-28UNF 201~210, X05~X09
 A-PT 1/8 211~218, X10~X20

2) For bearings with double- or triple-lip seals, unit and bearing number are suffixed by L2 or L3.
 (UCFC206JL3, UC206L3)
 3) For more detailed information, refer to ball bearing for unit specification tables.

Ball bearing units
pressed steel round-flanged type
SBPF (with set screws)

d 12 ~ 35 mm

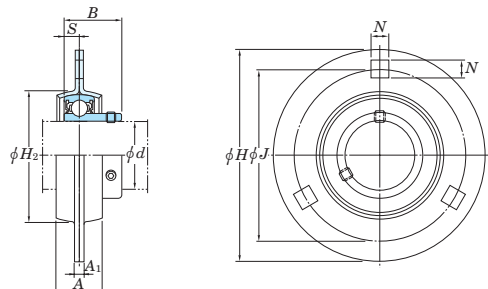

Shaft dia. (mm)	Dimensions (mm)								Bolt size	Unit No.	Housing No.	No.	Applicable bearing		Factor <i>f</i> ₀	(Refer.) Unit mass (kg)
	<i>H</i>	<i>A</i>	<i>A</i> ₁	<i>J</i> ±0.4	<i>N</i> ±0.25	<i>H</i> ₂ ¹⁾	<i>B</i>	<i>S</i>					<i>C</i> _r	<i>C</i> _{0r}		
12	81	14	4	63.5	7.1	49	22	6	M6	SBPF201	PF203	SB201	9.55	4.80	13.2	0.27
15	81	14	4	63.5	7.1	49	22	6	M6	SBPF202	PF203	SB202	9.55	4.80	13.2	0.27
17	81	14	4	63.5	7.1	49	22	6	M6	SBPF203	PF203	SB203	9.55	4.80	13.2	0.27
20	90	16	4	71.5	9	55	25	7	M8	SBPF204	PF204	SB204	12.8	6.65	13.2	0.33
25	95	18	4	76	9	60	27	7.5	M8	SBPF205	PF205	SB205	14.0	7.85	13.9	0.38
30	113	19	5.2	90.5	11	71	30	8	M10	SBPF206	PF206	SB206	19.5	11.3	13.9	0.62
35	122	22	5.2	100	11	81	32	8.5	M10	SBPF207	PF207	SB207	25.7	15.4	13.9	0.82

[Note] 1) *H*₂ shows minimum dimension of mounting hole.

[Remark] For more detailed information, refer to ball bearing for unit specification tables.

Ball bearing units
pressed steel rhombic-flanged type
SBPFL (with set screws)

d 12 ~ 35 mm

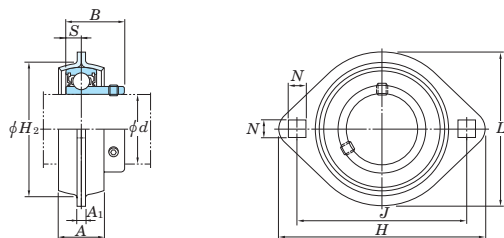

Shaft dia. (mm)	Dimensions (mm)									Bolt size	Unit No.	Housing No.	No.	Applicable bearing		Factor <i>f</i> ₀	(Refer.) Unit mass (kg)
	<i>H</i>	<i>L</i>	<i>A</i>	<i>A</i> ₁	<i>J</i> ±0.4	<i>N</i> ±0.25	<i>H</i> ₂ ¹⁾	<i>B</i>	<i>S</i>					<i>C</i> _r	<i>C</i> _{0r}		
12	81	59	14	4	63.5	7.1	49	22	6	M6	SBPFL201	PFL203	SB201	9.55	4.80	13.2	0.19
15	81	59	14	4	63.5	7.1	49	22	6	M6	SBPFL202	PFL203	SB202	9.55	4.80	13.2	0.19
17	81	59	14	4	63.5	7.1	49	22	6	M6	SBPFL203	PFL203	SB203	9.55	4.80	13.2	0.19
20	90	67	16	4	71.5	9	55	25	7	M8	SBPFL204	PFL204	SB204	12.8	6.65	13.2	0.24
25	95	71	18	4	76	9	60	27	7.5	M8	SBPFL205	PFL205	SB205	14.0	7.85	13.9	0.28
30	113	84	19	5.2	90.5	11	71	30	8	M10	SBPFL206	PFL206	SB206	19.5	11.3	13.9	0.38
35	122	94	22	5.2	100	11	81	32	8.5	M10	SBPFL207	PFL207	SB207	25.7	15.4	13.9	0.66

[Note] 1) *H*₂ shows minimum dimension of mounting hole.

[Remark] For more detailed information, refer to ball bearing for unit specification tables.

Ball bearing units
take-up type
UCT (with set screws)

d 12 ~ (55) mm

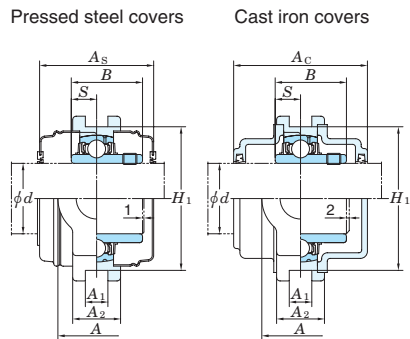
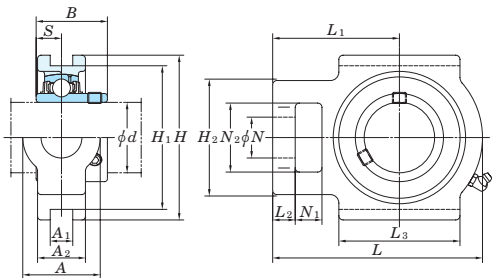

Tolerances for housing unit : mm

housing No.			ΔA_{1s}	ΔH_{1s}	X
T204- T210	TX05- TX10	T305- T310	+0.2 0	0 -0.5	0.5
T211- T217	TX11- TX17	T311- T315	+0.3 0	0 -0.8	0.6
		T319- T322			0.7
		T324- T328			0.8

ΔA_{1s} : deviation of nominal raceway groove width.
 ΔH_{1s} : deviation of distance between both groove bottoms.
 X : symmetry tolerance of both groove-side face.

T204JE3, T205JE3 (with cast iron covers) are shown below.
 T204JE3 $L_c = 97$ mm
 T205JE3 $L_c = 102$ mm

Shaft dia. (mm)	Dimensions (mm)															Unit No.	Housing No.	Applicable bearing			Unit No. with covers				Cover dimensions (mm)		(Refer.) Unit mass (kg)			
	d	A	A ₁	A ₂	H	H ₁	H ₂	L	L ₁	L ₂	L ₃	N	N ₁	N ₂	B			S	No.	Basic load ratings (kN)		Factor	Pressed steel covers		Cast iron covers		A _s	A _c	Pressed steel covers	Cast iron covers
																				C _r	C _{0r}		f ₀	Open ends	Closed end	Open ends				
12	32	12	21	89	76	51	94	61	10	51	19	16	32	31	12.7	UCT201	T204	UC201	12.8	6.65	13.2	UCT201C	UCT201CD	—	—	44	—	0.81	—	
15	32	12	21	89	76	51	94	61	10	51	19	16	32	31	12.7	UCT202	T204	UC202	12.8	6.65	13.2	UCT202C	UCT202CD	—	—	44	—	0.79	—	
17	32	12	21	89	76	51	94	61	10	51	19	16	32	31	12.7	UCT203	T204	UC203	12.8	6.65	13.2	UCT203C	UCT203CD	—	—	44	—	0.78	—	
20	32	12	21	89	76	51	94	61	10	51	19	16	32	31	12.7	UCT204	T204	UC204	12.8	6.65	13.2	UCT204C	UCT204CD	UCT204FC	UCT204FCD	44	62	0.76	1.1	
25	32	12	24	89	76	51	97	62	10	51	19	16	32	34.1	14.3	UCT205	T205	UC205	14.0	7.85	13.9	UCT205C	UCT205CD	UCT205FC	UCT205FCD	48	66	0.84	1.2	
	37	12	28	102	89	56	113	70	10	57	22	16	37	38.1	15.9	UCTX05	TX05	UCX05	19.5	11.3	13.9	UCTX05C	UCTX05CD	—	—	52	—	1.4	—	
	36	12	26	89	80	62	122	76	12	65	26	16	36	38	15	UCT305	T305	UC305	21.2	10.9	12.6	—	—	UCT305C	UCT305CD	—	76	1.4	2.0	
30	37	12	28	102	89	56	113	70	10	57	22	16	37	38.1	15.9	UCT206	T206	UC206	19.5	11.3	13.9	UCT206C	UCT206CD	UCT206FC	UCT206FCD	52	70	1.3	1.8	
	37	12	30	102	89	64	129	78	13	64	22	16	37	42.9	17.5	UCTX06	TX06	UCX06	25.7	15.4	13.9	UCTX06C	UCTX06CD	—	—	59	—	1.7	—	
	41	16	28	100	90	70	137	85	14	74	28	18	41	43	17	UCT306	T306	UC306	26.7	15.0	13.3	—	—	UCT306C	UCT306CD	—	82	1.8	2.4	
35	37	12	30	102	89	64	129	78	13	64	22	16	37	42.9	17.5	UCT207	T207	UC207	25.7	15.4	13.9	UCT207C	UCT207CD	UCT207FC	UCT207FCD	59	78	1.6	2.3	
	49	16	36	114	102	83	144	88	15	83	29	19	49	49.2	19	UCTX07	TX07	UCX07	29.1	17.8	14.0	UCTX07C	UCTX07CD	—	—	68	—	2.7	—	
	45	16	32	111	100	75	150	94	15	80	30	20	45	48	19	UCT307	T307	UC307	33.4	19.3	13.2	—	—	UCT307C	UCT307CD	—	88	2.3	3.1	
40	49	16	33	114	102	83	144	88	16	83	29	19	49	49.2	19	UCT208	T208	UC208	29.1	17.8	14.0	UCT208C	UCT208CD	UCT208FC	UCT208FCD	68	86	2.5	3.3	
	49	16	36	117	102	83	144	87	15	83	29	19	49	49.2	19	UCTX08	TX08	UCX08	32.7	20.3	14.0	UCTX08C	UCTX08CD	—	—	68	—	2.6	—	
	50	18	34	124	112	83	162	100	17	89	32	22	50	52	19	UCT308	T308	UC308	40.7	24.0	13.2	—	—	UCT308C	UCT308CD	—	96	3.0	4.0	
45	49	16	35	117	102	83	144	87	16	83	29	19	49	49.2	19	UCT209	T209	UC209	32.7	20.3	14.0	UCT209C	UCT209CD	UCT209FC	UCT209FCD	68	88	2.4	3.2	
	49	16	38	117	102	83	149	90	16	86	29	19	49	51.6	19	UCTX09	TX09	UCX09	35.1	23.3	14.4	UCTX09C	UCTX09CD	—	—	73	—	2.9	—	
	55	18	38	138	125	90	178	110	18	97	34	24	55	57	22	UCT309	T309	UC309	48.9	29.5	13.3	—	—	UCT309C	UCT309CD	—	102	4.1	5.4	
50	49	16	37	117	102	83	149	90	16	86	29	19	49	51.6	19	UCT210	T210	UC210	35.1	23.3	14.4	UCT210C	UCT210CD	UCT210FC	UCT210FCD	73	97	2.6	3.6	
	64	22	42	146	130	102	171	106	19	95	35	25	64	55.6	22.2	UCTX10	TX10	UCX10	43.4	29.4	14.4	UCTX10C	UCTX10CD	—	—	75	—	4.4	—	
	61	20	40	151	140	98	191	117	20	106	37	27	61	61	22	UCT310	T310	UC310	62.0	38.3	13.2	—	—	UCT310C	UCT310CD	—	110	4.9	6.5	
55	64	22	38	146	130	102	171	106	19	95	35	25	64	55.6	22.2	UCT211	T211	UC211	43.4	29.4	14.4	UCT211C	UCT211CD	UCT211FC	UCT211FCD	75	99	4.0	5.2	

[Remarks] 1) Applicable sizes of grease nipples are shown below.
 B-1/4-28UNF..... 201~210, X05~X09, 305~308
 B-PT 1/8 211~217, X10~X17, 309~328

2) For bearings with double- or triple-lip seals, unit and bearing number are suffixed by L2 or L3.
 (UCT206JL3, UC206L3)
 3) For more detailed information, refer to ball bearing for unit specification tables.

Ball bearing units

take-up type

UCT (with set screws)

d (55) ~ 100 mm

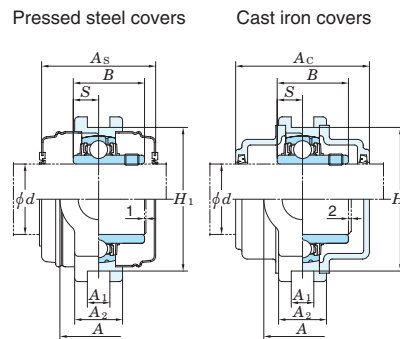
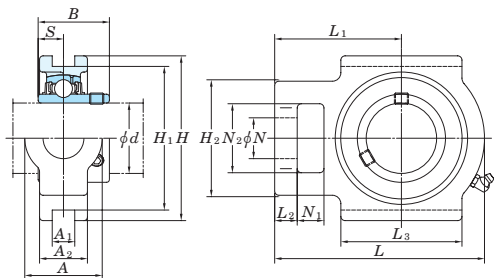

Tolerances for housing

housing No.			ΔA_{1s}	ΔH_{1s}	X
T204- T210	TX05- TX10	T305- T310	+0.2 0	0 -0.5	0.5
T211- T217	TX11- TX17	T311- T318			0.6
		T319- T322	+0.3 0	0 -0.8	0.7
		T324- T326			0.8

ΔA_{1s} : deviation of nominal raceway groove width.
 ΔH_{1s} : deviation of distance between both groove bottoms.
 X : symmetry tolerance of both groove-side face.

Shaft dia. (mm) d	Dimensions (mm)															Unit No.	Housing No.	Applicable bearing			Unit No. with covers				Cover dimensions (mm)		(Refer.) Unit mass (kg)		
	A	A ₁	A ₂	H	H ₁	H ₂	L	L ₁	L ₂	L ₃	N	N ₁	N ₂	B	S			No.	Basic load ratings (kN)		Factor	Pressed steel covers		Cast iron covers		A _s	A _c	Pressed steel covers	Cast iron covers
	C_r	C_{0r}	f_0	Open ends	Closed end	Open ends	Closed end																						
55	64	22	44	146	130	102	194	119	19	102	35	32	64	65.1	25.4	UCTX11	TX11	UCX11	52.4	36.2	14.4	UCTX11C	UCTX11CD	—	—	88	—	5.3	—
	66	22	44	163	150	105	207	127	21	115	39	29	66	66	25	UCT311	T311	UC311	71.6	45.0	13.2	—	—	UCT311C	UCT311CD	—	114	6.1	7.9
60	64	22	42	146	130	102	194	119	19	102	35	32	64	65.1	25.4	UCT212	T212	UC212	52.4	36.2	14.4	UCT212C	UCT212CD	UCT212FC	UCT212FCD	88	114	4.9	6.4
	70	26	48	167	151	111	224	137	21	121	41	32	70	65.1	25.4	UCTX12	TX12	UCX12	57.2	40.1	14.4	UCTX12C	UCTX12CD	—	—	88	—	7.4	—
	71	22	46	178	160	113	220	135	23	123	41	31	71	71	26	UCT312	T312	UC312	81.9	52.2	13.2	—	—	UCT312C	UCT312CD	—	124	7.6	9.9
65	70	26	44	167	151	111	224	137	21	121	41	32	70	65.1	25.4	UCT213	T213	UC213	57.2	40.1	14.4	UCT213C	UCT213CD	UCT213FC	UCT213FCD	88	114	6.9	8.6
	70	26	48	167	151	111	224	137	21	121	41	32	70	74.6	30.2	UCTX13	TX13	UCX13	62.2	44.1	14.5	UCTX13C	UCTX13CD	—	—	98	—	7.6	—
	80	26	50	190	170	116	238	146	25	134	43	32	70	75	30	UCT313	T313	UC313	92.7	59.9	13.2	—	—	UCT313C	UCT313CD	—	122	9.3	11.4
70	70	26	46	167	151	111	224	137	21	121	41	32	70	74.6	30.2	UCT214	T214	UC214	62.2	44.1	14.5	UCT214C	UCT214CD	UCT214FC	UCT214FCD	98	124	7.0	8.9
	70	26	48	167	151	111	232	140	21	121	41	32	70	77.8	33.3	UCTX14	TX14	UCX14	67.4	48.3	14.5	UCTX14C	UCTX14CD	—	—	98	—	7.9	—
	90	26	52	202	180	130	252	155	25	140	46	36	85	78	33	UCT314	T314	UC314	104	68.2	13.2	—	—	UCT314C	UCT314CD	—	124	11.1	13.4
75	70	26	48	167	151	111	232	140	21	121	41	32	70	77.8	33.3	UCT215	T215	UC215	67.4	48.3	14.5	UCT215C	UCT215CD	UCT215FC	UCT215FCD	98	124	7.3	9.2
	70	28	48	184	165	111	235	140	21	121	41	32	70	82.6	33.3	UCTX15	TX15	UCX15	72.7	53.0	14.6	UCTX15C	UCTX15CD	—	—	108	—	8.7	—
	90	26	55	216	192	132	262	160	25	150	46	36	85	82	32	UCT315	T315	UC315	113	77.2	13.2	—	—	UCT315C	UCT315CD	—	134	13.0	15.5
80	70	26	51	184	165	111	235	140	21	121	41	32	70	82.6	33.3	UCT216	T216	UC216	72.7	53.0	14.6	UCT216C	UCT216CD	UCT216FC	UCT216FCD	108	138	8.2	10.6
	73	28	54	198	173	124	260	162	28	157	48	38	73	85.7	34.1	UCTX16	TX16	UCX16	84.0	61.9	14.5	UCTX16C	UCTX16CD	—	—	112	—	11.7	—
	102	30	60	230	204	150	282	174	28	160	53	42	98	86	34	UCT316	T316	UC316	123	86.7	13.3	—	—	UCT316C	UCT316CD	—	138	16.2	19.1
85	73	30	54	198	173	124	260	162	29	157	48	38	73	85.7	34.1	UCT217	T217	UC217	84.0	61.9	14.5	UCT217C	UCT217CD	UCT217FC	UCT217FCD	112	142	11.0	13.7
	73	28	54	198	173	124	260	162	28	157	48	38	73	96	39.7	UCTX17	TX17	UCX17	96.1	71.5	14.5	UCTX17C	UCTX17CD	—	—	122	—	11.7	—
	102	32	64	240	214	152	298	183	30	170	53	42	98	96	40	UCT317	T317	UC317	133	96.8	13.3	—	—	UCT317C	UCT317CD	—	146	19.0	22.3
90	110	32	66	255	228	160	312	192	30	175	57	46	106	96	40	UCT318	T318	UC318	143	107	13.3	—	—	UCT318C	UCT318CD	—	150	21.6	25.4
95	110	35	72	270	240	165	322	197	31	180	57	46	106	103	41	UCT319	T319	UC319	153	119	13.3	—	—	UCT319C	UCT319CD	—	162	24.9	29.2
100	120	35	75	290	260	175	345	210	32	200	59	48	115	108	42	UCT320	T320	UC320	173	141	13.2	—	—	UCT320C	UCT320CD	—	174	30.7	36.3

(Remarks) 1) Applicable sizes of grease nipples are shown below.
 B-1/4-28UNF..... 201-210, X05-X09, 305-308
 B-PT 1/8..... 211-217, X10-X17, 309-328

2) For bearings with double- or triple-lip seals, unit and bearing number are suffixed by L2 or L3.
 (UCT0206JL3, UC206L3)
 3) For more detailed information, refer to ball bearing for unit specification tables.

Ball bearing units
take-up type
UCT (with set screws)

d 105 ~ 140 mm

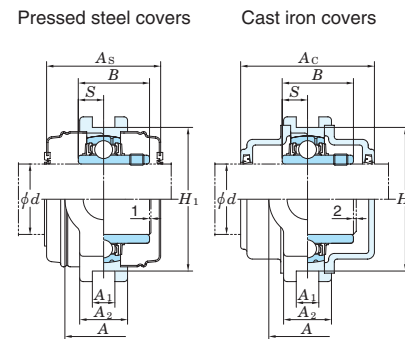
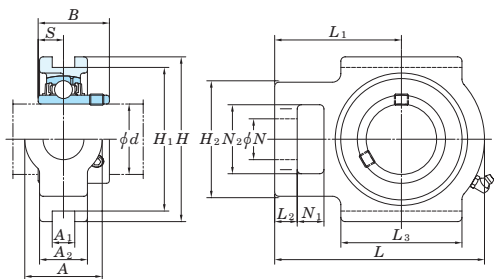

Tolerances for housing

housing No.			unit : mm		
			ΔA_{1s}	ΔH_{1s}	X
T204- T210	TX05- TX10	T305- T310	+0.2 0	0 -0.5	0.5
T211- T217	TX11- TX17	T311- T318			0.6
		T319- T322	+0.3 0	0 -0.8	0.7
		T324- T328			0.8

ΔA_{1s} : deviation of nominal raceway groove width.
 ΔH_{1s} : deviation of distance between both groove bottoms.
 X : symmetry tolerance of both groove-side face.

Shaft dia. (mm)	Dimensions (mm)															Unit No.	Housing No.	Applicable bearing			Unit No. with covers				Cover dimensions (mm)		(Refer.) Unit mass (kg)			
	<i>d</i>	A	A ₁	A ₂	H	H ₁	H ₂	L	L ₁	L ₂	L ₃	N	N ₁	N ₂	B			S	No.	Basic load ratings (kN)		Factor <i>f</i> ₀	Pressed steel covers		Cast iron covers		A _s	A _c	Pressed steel covers	Cast iron covers
																				C _r	C _{0r}		Open ends	Closed end	Open ends	Closed end				
105	120	35	75	290	260	175	345	210	32	200	59	48	115	112	44	UCT321	T321	UC321	184	153	13.2	—	—	UCT321C	UCT321CD	—	178	36.7	42.7	
110	130	38	80	320	285	185	385	235	38	215	65	52	125	117	46	UCT322	T322	UC322	205	180	13.2	—	—	UCT322C	UCT322CD	—	188	39.7	46.5	
120	140	45	90	355	320	210	432	267	42	230	70	60	140	126	51	UCT324	T324	UC324	207	185	13.5	—	—	UCT324C	UCT324CD	—	196	54.4	63.9	
130	150	50	100	385	350	220	465	285	45	240	75	65	150	135	54	UCT326	T326	UC326	229	214	13.6	—	—	UCT326C	UCT326CD	—	214	69.3	81.4	
140	155	50	100	415	380	230	515	315	50	255	80	70	160	145	59	UCT328	T328	UC328	253	246	13.6	—	—	UCT328C	UCT328CD	—	222	85.1	101	

[Remarks] 1) Applicable sizes of grease nipples are shown below.
 B-1/4-28UNF..... 201~210, X05~X09, 305~308
 B-PT 1/8..... 211~217, X10~X17, 309~328

2) For bearings with double- or triple-lip seals, unit and bearing number are suffixed by L2 or L3.
 (UCT206JL3, UC206L3)
 3) For more detailed information, refer to ball bearing for unit specification tables.

**Ball bearing units
cartridge type
UCC (with set screws)**

d 12 ~ 50 mm

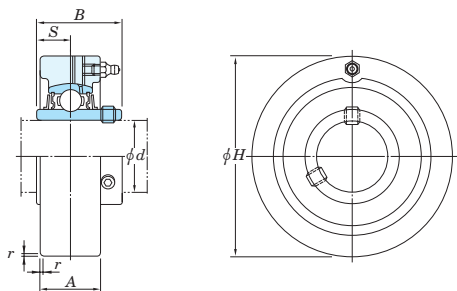

d 55 ~ 130 mm

Tolerances for housing

unit : mm

housing No.		ΔH_s	ΔA_s	Y
C204- C205		0 -0.030	±0.2	0.2
C206- C210	CX05- CX08 C305- C308	0 -0.035		
C211- C213	CX09- CX10 C309- C310	0 -0.040	±0.3	0.3
	CX11- CX12 C311- C314	0 -0.046		
	C315- C318 C319	0 -0.052		0.4
	C320- C322 C324- C326	0 -0.057		

ΔH_s : deviation of outside diameter.
 ΔA_s : deviation of width.
 Y : circumferential runout tolerances of outside diameter in respect to shaft straight line of spherical bearing seating.

Shaft dia. (mm) d	Dimensions (mm)					Unit No.	Housing No.	No.	Applicable bearing		Factor f_0	(Refer.) Unit mass (kg)
	H	A	r	B	S				C_r	C_{0r}		
12	72	20	1.5	31	12.7	UCC201	C204	UC201	12.8	6.65	13.2	0.52
15	72	20	1.5	31	12.7	UCC202	C204	UC202	12.8	6.65	13.2	0.50
17	72	20	1.5	31	12.7	UCC203	C204	UC203	12.8	6.65	13.2	0.49
20	72	20	1.5	31	12.7	UCC204	C204	UC204	12.8	6.65	13.2	0.47
25	80	22	1.5	34.1	14.3	UCC205	C205	UC205	14.0	7.85	13.9	0.64
	90	27	1.5	38.1	15.9	UCCX05	CX05	UCX05	19.5	11.3	13.9	1.0
	90	26	2	38	15	UCC305	C305	UC305	21.2	10.9	12.6	1.5
30	85	27	1.5	38.1	15.9	UCC206	C206	UC206	19.5	11.3	13.9	0.81
	100	30	2	42.9	17.5	UCCX06	CX06	UCX06	25.7	15.4	13.9	1.3
	100	28	2	43	17	UCC306	C306	UC306	26.7	15.0	13.3	1.7
35	90	28	2	42.9	17.5	UCC207	C207	UC207	25.7	15.4	13.9	0.93
	110	34	2	49.2	19	UCCX07	CX07	UCX07	29.1	17.8	14.0	1.7
	110	32	3	48	19	UCC307	C307	UC307	33.4	19.3	13.2	2.2
40	100	30	2	49.2	19	UCC208	C208	UC208	29.1	17.8	14.0	1.2
	120	38	2	49.2	19	UCCX08	CX08	UCX08	32.7	20.3	14.0	2.3
	120	34	3	52	19	UCC308	C308	UC308	40.7	24.0	13.2	2.2
45	110	31	2	49.2	19	UCC209	C209	UC209	32.7	20.3	14.0	1.5
	120	38	2	51.6	19	UCCX09	CX09	UCX09	35.1	23.3	14.4	2.3
	130	38	3	57	22	UCC309	C309	UC309	48.9	29.5	13.3	2.8
50	120	33	2	51.6	19	UCC210	C210	UC210	35.1	23.3	14.4	2.0
	130	40	2.5	55.6	22.2	UCCX10	CX10	UCX10	43.4	29.4	14.4	2.8
	140	40	3	61	22	UCC310	C310	UC310	62.0	38.3	13.2	3.2

Shaft dia. (mm) d	Dimensions (mm)					Unit No.	Housing No.	No.	Applicable bearing		Factor f_0	(Refer.) Unit mass (kg)
	H	A	r	B	S				C_r	C_{0r}		
55	125	35	2.5	55.6	22.2	UCC211	C211	UC211	43.4	29.4	14.4	2.2
	150	42	2.5	65.1	25.4	UCCX11	CX11	UCX11	52.4	36.2	14.4	4.0
	150	44	3	66	25	UCC311	C311	UC311	71.6	45.0	13.2	3.9
60	130	38	2.5	65.1	25.4	UCC212	C212	UC212	52.4	36.2	14.4	2.6
	160	44	2.5	65.1	25.4	UCCX12	CX12	UCX12	57.2	40.1	14.4	4.6
	160	46	3	71	26	UCC312	C312	UC312	81.9	52.2	13.2	4.8
65	140	40	2.5	65.1	25.4	UCC213	C213	UC213	57.2	40.1	14.4	3.0
	170	50	3	75	30	UCC313	C313	UC313	92.7	59.9	13.2	5.7
70	180	52	3	78	33	UCC314	C314	UC314	104	68.2	13.2	6.7
75	190	55	4	82	32	UCC315	C315	UC315	113	77.2	13.2	7.8
80	200	60	4	86	34	UCC316	C316	UC316	123	86.7	13.3	9.2
85	215	64	4	96	40	UCC317	C317	UC317	133	96.8	13.3	11.7
90	225	66	4	96	40	UCC318	C318	UC318	143	107	13.3	13.1
95	240	72	4	103	41	UCC319	C319	UC319	153	119	13.3	15.8
100	260	75	4	108	42	UCC320	C320	UC320	173	141	13.2	19.6
105	260	75	4	112	44	UCC321	C321	UC321	184	153	13.2	27.0
110	300	80	5	117	46	UCC322	C322	UC322	205	180	13.2	29.2
120	320	90	5	126	51	UCC324	C324	UC324	207	185	13.5	35.9
130	340	100	6	135	54	UCC326	C326	UC326	229	214	13.6	43.0

[Remarks] 1) Applicable sizes of grease nipples are shown below.
 A-1/4-28UNF 201~213, X05~X12, 305~308
 A-PT 1/8 309~328

2) For bearings with double- or triple-lip seals, unit and bearing number are suffixed by L2 or L3.
 (UCC206JL3, UC206L3)

3) For more detailed information, refer to ball bearing for unit specification tables.

**Ball bearing units
cartridge type
UCC (with set screws)**

d 140 mm

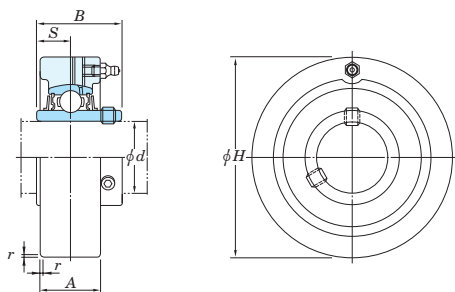

Shaft dia. (mm) <i>d</i>	Dimensions (mm)					Unit No.	Housing No.	No.	Applicable bearing		Factor <i>f</i> ₀	(Refer.) Unit mass (kg)
	<i>H</i>	<i>A</i>	<i>r</i>	<i>B</i>	<i>S</i>				<i>C</i> _r	<i>C</i> _{0r}		
140	360	100	6	145	59	UCC328	C328	UC328	253	246	13.6	52.9

- [Remarks]
- Applicable sizes of grease nipples are shown below.
 A-1/4-28UNF 201~213, X05~X12, 305~308
 A-PT 1/8 309~328
 - For bearings with double- or triple-lip seals, unit and bearing number are suffixed by L2 or L3.
 (UCC206JL3, UC206L3)
 - For more detailed information, refer to ball bearing for unit specification tables.

Tolerances for housing

unit : mm

housing No.	ΔH_s	ΔA_s	Y
C204- C205	0 -0.030	±0.2	0.2
C206- C210	CX05- CX08		
C211- C213	CX09- CX10	C309- C310	0 -0.040
	CX11- CX12	C311- C314	0 -0.046
	C315- C318	0 -0.046	±0.3
	C319	-0.052	
	C320- C322	0 -0.052	0.4
	C324- C326	0 -0.057	

ΔH_s : deviation of outside diameter.
 ΔA_s : deviation of width.
 Y : circumferential runout tolerances
 of outside diameter in respect to
 shaft straight line of spherical
 bearing seating.

Ball bearings for units
cylindrical bore type (with set screws)

d 8 ~ (35) mm

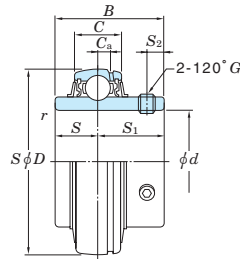

UC

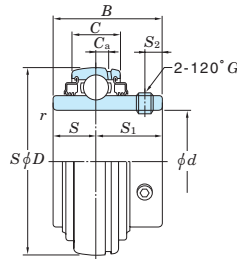

UC-L3

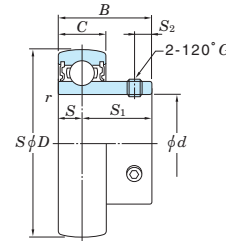

SB

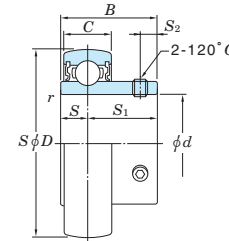

SU

Shaft dia. (mm) d	Boundary dimensions (mm)				Basic load ratings (kN)		Factor f_0	Bearing No.		Dimensions (mm)				Set screw size G	(Refer.) Mass (kg)
	D	B	C	$r_{min.}$	C_r	C_{0r}		With standard seals	With triple-lip seals	C_a	S	S_1	S_2		
8	22	12	7	0.3	3.27	1.37	12.4	SU08	—	—	3.5	8.5	2.8	M3×0.35	0.012
10	26	15	8	0.3	4.55	1.95	12.3	SU000	—	—	5	10	3	M3×0.35	0.024
12	28	15	8	0.3	5.10	2.40	13.2	SU001	—	—	5	10	3	M3×0.35	0.026
	40	22	12	0.6	9.55	4.80	13.2	SB201	—	—	6	16	4	M5×0.5	0.10
	47	31	16	0.6	12.8	6.65	13.2	UC201	UC201L2	4	12.7	18.3	5	M6×0.75	0.21
15	32	16.5	9	0.3	5.60	2.85	13.9	SU002	—	—	5.5	11	3.3	M4×0.5	0.038
	40	22	12	0.6	9.55	4.80	13.2	SB202	—	—	6	16	4	M5×0.5	0.10
	47	31	16	0.6	12.8	6.65	13.2	UC202	UC202L2	4	12.7	18.3	5	M6×0.75	0.19
17	35	17.5	10	0.3	6.00	3.25	14.4	SU003	—	—	6	11.5	3.3	M4×0.5	0.050
	40	22	12	0.6	9.55	4.80	13.2	SB203	—	—	6	16	4	M5×0.5	0.10
	47	31	16	0.6	12.8	6.65	13.2	UC203	UC203L2	4	12.7	18.3	5	M6×0.75	0.18
20	42	21	12	0.6	9.40	5.05	13.9	SU004	—	—	7	14	4	M5×0.5	0.080
	47	25	14	1	12.8	6.65	13.2	SB204	—	—	7	18	5	M6×0.75	0.15
	47	31	16	1	12.8	6.65	13.2	UC204	UC204L2	4	12.7	18.3	5	M6×0.75	0.16
25	47	22	12	0.6	10.1	5.85	14.5	SU005	—	—	7	15	4.5	M5×0.5	0.10
	52	27	15	1	14.0	7.85	13.9	SB205	—	—	7.5	19.5	5.5	M6×0.75	0.18
	52	34.1	17	1	14.0	7.85	13.9	UC205	UC205L2	3.5	14.3	19.8	5.5	M6×0.75	0.20
	62	38	22	1.1	21.2	10.9	13.2	UC305	—	—	5	15	23	6	M6×0.75
30	62	38.1	19	1	19.5	11.3	13.9	UCX05	UCX05L3	4.5	15.9	22.2	6	M6×0.75	0.39
	55	24.5	13	1	13.2	8.25	14.7	SU006	—	—	7.5	17	5.5	M5×0.5	0.15
	62	30	16	1	19.5	11.3	13.9	SB206	—	—	8	22	6	M6×0.75	0.27
	62	38.1	19	1	19.5	11.3	13.9	UC206	UC206L3	4.5	15.9	22.2	6	M6×0.75	0.32
	72	42.9	20	1	25.7	15.4	13.9	UCX06	UCX06L3	4.5	17.5	25.4	6.5	M8×1	0.58
72	43	24	1.1	26.7	15.0	13.3	UC306	—	—	5.5	17	26	6	M6×0.75	0.56
35	72	32	17	1.1	25.7	15.4	13.9	SB207	—	—	8.5	23.5	6	M6×0.75	0.42

[Remarks] 1) SU type bearings are ball bearings for compact series units.
 2) UC201 to UC205 are with double-lip seals.

Ball bearings for units
cylindrical bore type (with set screws)

d (35) ~ (75) mm

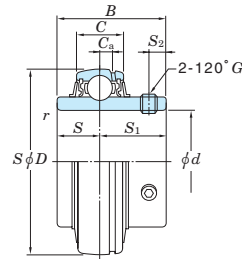

UC

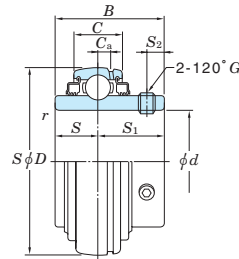

UC-L3

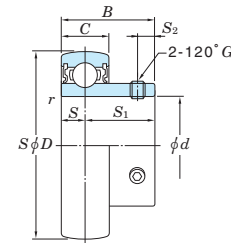

SB

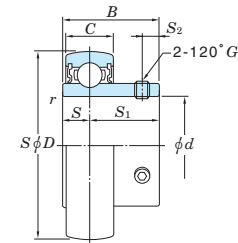

SU

Shaft dia. (mm) d	Boundary dimensions (mm)				Basic load ratings (kN)		Factor f_0	Bearing No.		Dimensions (mm)				Set screw size G	(Refer.) Mass (kg)
	D	B	C	$r_{min.}$	C_r	C_{Or}		With standard seals	With triple-lip seals	C_a	S	S_1	S_2		
35	72	42.9	20	1.1	25.7	15.4	13.9	UC207	UC207L3	4.5	17.5	25.4	6.5	M8×1	0.48
	80	48	26	1.5	33.4	19.3	13.2	UC307	UC307L3	5.5	19	29	8	M8×1	0.71
	80	49.2	21	1.1	29.1	17.8	14.0	UCX07	UCX07L3	4.5	19	30.2	8	M8×1	0.75
40	80	34	18	1.1	29.1	17.8	14.0	SB208	—	—	9	25	8	M8×1	0.60
	80	49.2	21	1.1	29.1	17.8	14.0	UC208	UC208L3	4.5	19	30.2	8	M8×1	0.64
	85	49.2	22	1.1	32.7	20.3	14.0	UCX08	UCX08L3	5	19	30.2	8	M8×1	0.83
	90	52	28	1.5	40.7	24.0	13.2	UC308	UC308L3	6	19	33	10	M10×1.25	1.00
45	85	49.2	22	1.1	32.7	20.3	14.0	UC209	UC209L3	5	19	30.2	8	M8×1	0.68
	90	51.6	24	1.1	35.1	23.3	14.4	UCX09	UCX09L3	6	19	32.6	9	M10×1.25	0.95
	100	57	30	1.5	48.9	29.5	13.3	UC309	UC309L3	6.5	22	35	10	M10×1.25	1.33
50	90	51.6	24	1.1	35.1	23.3	14.4	UC210	UC210L3	6	19	32.6	9	M10×1.25	0.80
	100	55.6	25	1.1	43.4	29.4	14.4	UCX10	UCX10L3	5.5	22.2	33.4	9	M10×1.25	1.29
	110	61	32	2	62.0	38.3	13.2	UC310	UC310L3	7	22	39	12	M12×1.5	1.69
55	100	55.6	25	1.5	43.4	29.4	14.4	UC211	UC211L3	5.5	22.2	33.4	9	M10×1.25	1.11
	110	65.1	27	1.5	52.4	36.2	14.4	UCX11	UCX11L3	6	25.4	39.7	10.5	M10×1.25	1.80
	120	66	34	2	71.6	45.0	13.2	UC311	UC311L3	7	25	41	12	M12×1.5	1.90
60	110	65.1	27	1.5	52.4	36.2	14.4	UC212	UC212L3	6	25.4	39.7	10.5	M10×1.25	1.54
	120	65.1	28	1.5	57.2	40.1	14.4	UCX12	UCX12L3	6.5	25.4	39.7	12	M12×1.5	2.05
	130	71	36	2.1	81.9	52.2	13.2	UC312	UC312L3	6.5	26	45	12	M12×1.5	2.60
65	120	65.1	28	1.5	57.2	40.1	14.4	UC213	UC213L3	6.5	25.4	39.7	12	M12×1.5	1.86
	125	74.6	30	1.5	62.2	44.1	14.5	UCX13	UCX13L3	6	30.2	44.4	12	M12×1.5	2.52
	140	75	38	2.1	92.7	59.9	13.2	UC313	UC313L3	7	30	45	12	M12×1.5	3.16
70	125	74.6	30	1.5	62.2	44.1	14.5	UC214	UC214L3	6	30.2	44.4	12	M12×1.5	2.05
	130	77.8	32	1.5	67.4	48.3	14.5	UCX14	UCX14L3	7	33.3	44.5	12	M12×1.5	2.74
	150	78	40	2.1	104	68.2	13.2	UC314	UC314L3	7.5	33	45	12	M12×1.5	3.90
75	130	77.8	32	1.5	67.4	48.3	14.5	UC215	UC215L3	7	33.3	44.5	12	M12×1.5	2.21

Ball bearings for units
cylindrical bore type (with set screws)

d (75) ~ 140 mm

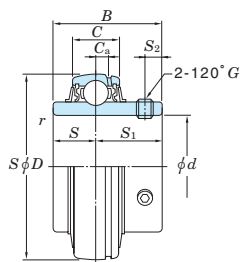

UC

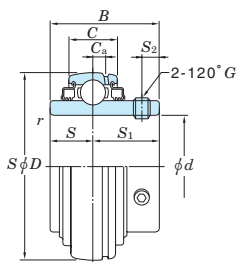

UC-L3

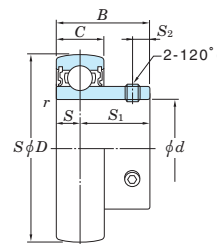

SB

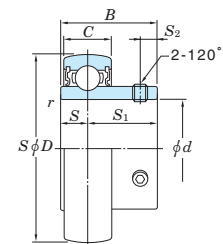

SU

Shaft dia. (mm) <i>d</i>	Boundary dimensions (mm)				Basic load ratings (kN)		Factor <i>f</i> ₀	Bearing No.		Dimensions (mm)				Set screw size <i>G</i>	(Refer.) Mass (kg)
	<i>D</i>	<i>B</i>	<i>C</i>	<i>r</i> _{min.}	<i>C</i> _r	<i>C</i> _{0r}		With standard seals	With triple-lip seals	<i>C</i> _a	<i>S</i>	<i>S</i> ₁	<i>S</i> ₂		
75	140	82.6	33	1.5	72.7	53.0	14.6	UCX15	UCX15L3	7.5	33.3	49.3	14	M12×1.5	3.41
	160	82	42	2.1	113	77.2	13.2	UC315	UC315L3	6.5	32	50	14	M14×1.5	4.70
80	140	82.6	33	2	72.7	53.0	14.6	UC216	UC216L3	7.5	33.3	49.3	14	M12×1.5	2.79
	150	85.7	35	2	84.0	61.9	14.5	UCX16	UCX16L3	7.5	34.1	51.6	14	M12×1.5	3.87
	170	86	44	2.1	123	86.7	13.3	UC316	UC316L3	7	34	52	14	M14×1.5	5.60
85	150	85.7	35	2	84.0	61.9	14.5	UC217	UC217L3	7.5	34.1	51.6	14	M12×1.5	3.45
	160	96	38	2	96.1	71.5	14.5	UCX17	UCX17L3	8	39.7	56.3	15	M12×1.5	5.05
	180	96	46	3	133	96.8	13.3	UC317	UC317L3	8	40	56	16	M16×1.5	6.90
90	160	96	38	2	96.1	71.5	14.5	UC218	UC218L3	8	39.7	56.3	15	M12×1.5	4.35
	170	104	40	2	109	81.9	14.4	UCX18	—	8.5	42.9	61.1	16	M14×1.5	6.00
	190	96	48	3	143	107	13.3	UC318	UC318L3	8.5	40	56	16	M16×1.5	7.87
95	200	103	50	3	153	119	13.3	UC319	UC319L3	8.5	41	62	18	M16×1.5	8.91
100	190	117.5	43	2.1	133	105	14.4	UCX20	—	8.5	49.2	68.3	18	M16×1.5	8.56
	215	108	54	3	173	141	13.2	UC320	UC320L3	9	42	66	20	M18×1.5	11.2
105	225	112	56	3	184	153	13.2	UC321	—	9	44	68	20	M18×1.5	12.7
110	240	117	60	3	205	180	13.2	UC322	UC322L3	10	46	71	20	M18×1.5	15.1
120	260	126	64	3	207	185	13.5	UC324	UC324L3	11	51	75	20	M18×1.5	19.0
130	280	135	68	4	229	214	13.6	UC326	UC326L3	12	54	81	20	M20×1.5	23.6
140	300	145	72	4	253	246	13.6	UC328	UC328L3	13	59	86	20	M20×1.5	29.4

Ball bearings for units tapered bore type (with adapter)

d₁ 20 ~ 55 mm

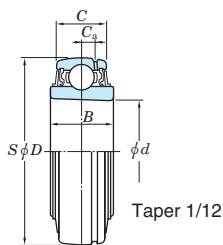

UK

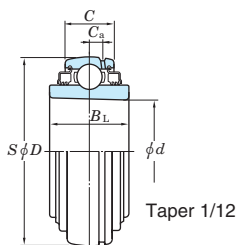

UK...L3
(with triple-lip seals)

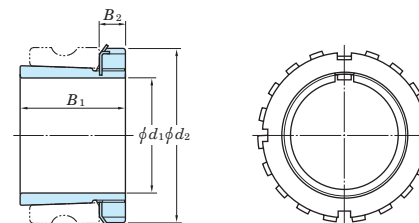

Adapter assembly

Shaft dia. (mm) d ₁	Boundary dimensions (mm)						Basic load ratings (kN)		Factor f ₀	Bearing No.		(Refer.) Mass (kg) With standard seals	With triple-lip seals	Applicable adapter assembly (H3 series ¹⁾)				Applicable adapter assembly (H23 series ¹⁾)							
	d	D	B	B _L	C	C _a	C _r	C _{0r}		With standard seals	With triple-lip seals			No.	Dimensions (mm)			Mass (kg)	Sleeve No.	No.	Dimensions (mm)			Mass (kg)	Sleeve No.
20	25	52	21	24	17	5	14.0	7.85	13.9	UK205	UK205L2	0.16	0.18	H305X	29	8	38	0.085	A305X	H2305X	35	8	38	0.097	A2305X
	25	62	23	—	19	5	19.5	11.3	13.9	UKX05	—	0.27	—	—	—	—	—	—	H2305X	35	8	38	0.097	A2305X	
	25	62	27	—	22	6	21.2	10.9	12.6	UK305	—	0.40	—	—	—	—	—	—	H2305X	35	8	38	0.097	A2305X	
25	30	62	23	27	19	5	19.5	11.3	13.9	UK206	UK206L3	0.25	0.29	H306X	31	8	45	0.11	A306X	H2306X	38	8	45	0.13	A2306X
	30	72	26	—	20	5.5	25.7	15.4	13.9	UKX06	—	0.43	—	—	—	—	—	—	H2306X	38	8	45	0.13	A2306X	
	30	72	30	—	24	6.5	26.7	15.0	13.3	UK306	—	0.47	—	—	—	—	—	—	H2306X	38	8	45	0.13	A2306X	
30	35	72	26	30	20	5.5	25.7	15.4	13.9	UK207	UK207L3	0.37	0.43	H307X	35	9	52	0.16	A307X	H2307X	43	9	52	0.19	A2307X
	35	80	27	—	21	6	29.1	17.8	14.0	UKX07	—	0.53	—	—	—	—	—	—	H2307X	43	9	52	0.19	A2307X	
	35	80	33	33	26	7.5	33.4	19.3	13.2	UK307	UK307L3	0.60	—	—	—	—	—	—	H2307X	43	9	52	0.19	A2307X	
35	40	80	27	34	21	6	29.1	17.8	14.0	UK208	UK208L3	0.47	0.58	H308X	36	10	58	0.20	A308X	H2308X	46	10	58	0.24	A2308X
	40	85	29	—	22	6	32.7	20.3	14.0	UKX08	—	0.58	—	—	—	—	—	—	H2308X	46	10	58	0.24	A2308X	
	40	90	35	35	28	8	40.7	24.0	13.2	UK308	UK308L3	0.80	—	—	—	—	—	—	H2308X	46	10	58	0.24	A2308X	
40	45	85	29	36	22	6	32.7	20.3	14.0	UK209	UK209L3	0.52	0.65	H309X	39	11	65	0.27	A309X	H2309X	50	11	65	0.31	A2309X
	45	90	29	—	24	6	35.1	23.3	14.4	UKX09	—	0.67	—	—	—	—	—	—	H2309X	50	11	65	0.31	A2309X	
	45	100	38	38	30	8.5	48.9	29.5	13.3	UK309	UK309L3	1.08	—	—	—	—	—	—	H2309X	50	11	65	0.31	A2309X	
45	50	90	29	36	24	6	35.1	23.3	14.4	UK210	UK210L3	0.59	0.65	H310X	42	12	70	0.32	A310X	H2310X	55	12	70	0.39	A2310X
	50	100	31	—	25	7	43.4	29.4	14.4	UKX10	—	0.89	—	—	—	—	—	—	H2310X	55	12	70	0.39	A2310X	
	50	110	40	40	32	9	62.0	38.3	13.2	UK310	UK310L3	1.38	—	—	—	—	—	—	H2310X	55	12	70	0.39	A2310X	
50	55	100	31	40	25	7	43.4	29.4	14.4	UK211	UK211L3	0.80	1.09	H311X	45	12	75	0.37	A311X	H2311X	59	12	75	0.45	A2311X
	55	110	33	—	27	7.5	52.4	36.2	14.4	UKX11	—	1.15	—	—	—	—	—	—	H2311X	59	12	75	0.45	A2311X	
	55	120	43	43	34	10	71.6	45.0	13.2	UK311	UK311L3	1.78	—	—	—	—	—	—	H2311X	59	12	75	0.45	A2311X	
55	60	110	33	47	27	7.5	52.4	36.2	14.4	UK212	UK212L3	1.02	1.41	H312X	47	13	80	0.42	A312X	H2312X	62	13	80	0.51	A2312X
	60	120	36	—	28	7.5	57.2	40.1	14.4	UKX12	—	1.45	—	—	—	—	—	—	H2312X	62	13	80	0.51	A2312X	
	60	130	47	47	36	11.5	81.9	52.2	13.2	UK312	UK312L3	2.06	—	—	—	—	—	—	H2312X	62	13	80	0.51	A2312X	

[Remarks] 1) For bearings with adapters, bearing numbers shown in dimension tables are suffixed by applicable adapter assembly numbers.

(UK206+H306X, UK206L3+H2306X)

2) Adapter assemblies applicable to UK 2 series are classified as follows.

- UK2 H3 series
- UK2...L3 H23 series

3) UK205 is with double-lip seals.

4) Please consult with JTEKT when using adapter with inch series bore diameter.

Ball bearings for units tapered bore type (with adapter)

d_1 60 ~ 125 mm

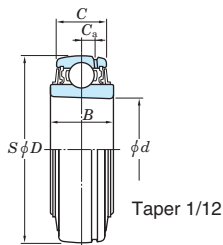

UK

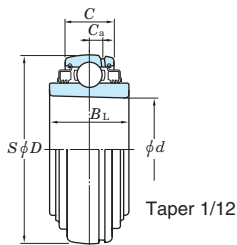

UK...L3
(with triple-lip seals)

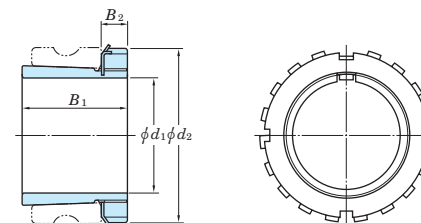

Adapter assembly

Shaft dia. (mm)	Boundary dimensions (mm)						Basic load ratings (kN)		Factor f_0	Bearing No.		(Refer.) Mass (kg)		Applicable adapter assembly (H3 series ¹⁾)				Applicable adapter assembly (H23 series ¹⁾)							
	d	D	B	B_L	C	C_a	C_r	C_{0r}		With standard seals	With triple-lip seals	With standard seals	With triple-lip seals	No.	Dimensions (mm)			Mass (kg)	Sleeve No.	No.	Dimensions (mm)			Mass (kg)	Sleeve No.
60	65	120	36	47	28	7.5	57.2	40.1	14.4	UK213	UK213L3	1.34	1.67	H313X	50	14	85	0.49	A313X	H2313X	65	14	85	0.59	A2313X
	65	125	40	—	30	9	62.2	44.1	14.5	UKX13	—	1.62	—	—	—	—	—	—	H2313X	65	14	85	0.59	A2313X	
	65	140	49	49	38	12	92.7	59.9	13.2	UK313	UK313L3	2.71	—	—	—	—	—	H2313X	65	14	85	0.59	A2313X		
65	75	130	40	51	32	9	67.4	48.3	14.5	UK215	UK215L3	1.50	1.99	H315X	55	15	98	0.89	A315X	H2315X	73	15	98	1.11	A2315X
	75	140	42	—	33	9	72.7	53.0	14.6	UKX15	—	2.10	—	—	—	—	—	H2315X	73	15	98	1.11	A2315X		
	75	160	55	55	42	14.5	113	77.2	13.2	UK315	UK315L3	3.80	—	—	—	—	—	H2315X	73	15	98	1.11	A2315X		
70	80	140	42	55	33	9	72.7	53.0	14.6	UK216	UK216L3	1.96	2.56	H316X	59	17	105	1.09	A316X	H2316X	78	17	105	1.34	A2316X
	80	150	44	—	35	10	84.0	61.9	14.5	UKX16	—	2.64	—	—	—	—	—	H2316X	78	17	105	1.34	A2316X		
	80	170	55	55	44	15	123	86.7	13.3	UK316	UK316L3	4.39	—	—	—	—	—	H2316X	78	17	105	1.34	A2316X		
75	85	150	44	57	35	10	84.0	61.9	14.5	UK217	UK217L3	2.42	3.10	H317X	63	18	110	1.24	A317X	H2317X	82	18	110	1.52	A2317X
	85	160	48	—	38	11	96.1	71.5	14.5	UKX17	—	3.25	—	—	—	—	—	H2317X	82	18	110	1.52	A2317X		
	85	180	60	60	46	15	133	96.8	13.3	UK317	UK317L3	5.30	—	—	—	—	—	H2317X	82	18	110	1.52	A2317X		
80	90	160	48	63	38	11	96.1	71.5	14.5	UK218	UK218L3	2.90	3.77	H318X	65	18	120	1.45	A318X	H2318X	86	18	120	1.70	A2318X
	90	170	50	—	40	11.5	109	81.9	14.4	UKX18	—	3.80	—	—	—	—	—	H2318X	86	18	120	1.70	A2318X		
	90	190	60	60	48	15.5	143	107	13.3	UK318	UK318L3	6.20	—	—	—	—	—	H2318X	86	18	120	1.70	A2318X		
85	95	200	66	66	50	16.5	153	119	13.3	UK319	UK319L3	7.31	—	—	—	—	—	H2319X	90	19	125	1.99	A2319X		
90	100	190	54	—	43	13	133	105	14.4	UKX20	—	5.36	—	—	—	—	—	H2320X	97	20	130	2.28	A2320X		
	100	215	68	68	54	18	173	141	13.2	UK320	UK320L3	8.70	—	—	—	—	—	H2320X	97	20	130	2.28	A2320X		
100	110	240	78	78	60	20	205	180	13.2	UK322	UK322L3	12.2	—	—	—	—	—	H2322X	105	21	145	2.87	A2322X		
110	120	260	87	87	64	21	207	185	13.5	UK324	UK324L3	16.1	—	—	—	—	—	H2324X	112	22	155	3.32	A2324X		
115	130	280	87	87	68	22	229	214	13.6	UK326	UK326L3	18.8	—	—	—	—	—	H2326	121	23	165	4.82	A2326		
125	140	300	97	97	72	23	253	246	13.6	UK328	UK328L3	23.9	—	—	—	—	—	H2328	131	24	180	5.86	A2328		

[Remarks] 1) For bearings with adapters, bearing numbers shown in dimension tables are suffixed by applicable adapter assembly numbers.
(UK206+H306X, UK206L3+H2306X)
2) Adapter assemblies applicable to UK 2 series are classified as follows.
UK2..... H3 series
UK2...L3 H23 series

3) Please consult with JTEKT when using adapter with inch series bore diameter.

Ball bearings for units
cylindrical bore type (with eccentric locking collar)

d 20 ~ 60 mm

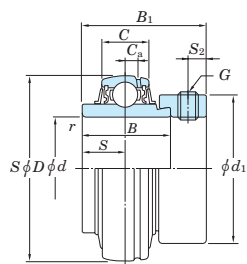

NA

Shaft dia. (mm) <i>d</i>	Boundary dimensions (mm)					Basic load ratings (kN)		Factor <i>f</i> ₀	Bearing No.	Dimensions (mm)				Set screw size <i>G</i>	(Refer.) Mass (kg)
	<i>D</i>	<i>B</i>	<i>B</i> ₁	<i>C</i>	<i>r</i> min.	<i>C</i> _r	<i>C</i> _{0r}			<i>C</i> _a	<i>S</i>	<i>S</i> ₂	<i>d</i> ₁		
20	47	34.2	43.7	16	1	12.8	6.65	13.2	NA204	4	17.1	4.8	33.3	M6×0.75	0.22
25	52	34.9	44.4	17	1	14.0	7.85	13.9	NA205	5	17.5	4.8	38.1	M6×0.75	0.25
30	62	36.5	48.4	19	1	19.5	11.3	13.9	NA206	5	18.3	6	44.5	M8×1	0.41
35	72	37.6	51.1	20	1.1	25.7	15.4	13.9	NA207	5.5	18.8	6.8	55.6	M8×1	0.61
40	80	42.8	56.3	21	1.1	29.1	17.8	14.0	NA208	6	21.4	6.8	60.3	M8×1	0.78
45	85	42.8	56.3	22	1.1	32.7	20.3	14.0	NA209	6	21.4	6.8	63.5	M8×1	0.85
50	90	49.2	62.7	24	1.1	35.1	23.3	14.4	NA210	6	24.6	6.8	69.9	M8×1	1.01
55	100	55.5	71.4	25	1.5	43.4	29.4	14.4	NA211	7	27.8	8	76.2	M10×1.25	1.39
60	110	61.9	77.8	27	1.5	52.4	36.2	14.4	NA212	7.5	31	8	84.2	M10×1.25	1.87

Plummer blocks

Plummer blocks consist of self-aligning ball bearings or spherical roller bearings, and a housing in which the bearings are installed. The housing varies in shape. Having a large load capacity and being easy to handle, plummer blocks are employed in a variety of industrial machines, such as carrying machines.



Split type : standard

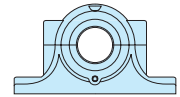

Bore diameter 20 – 170 mm

Split type : flat bottom

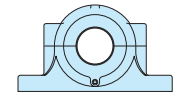

Bore diameter 20 – 140 mm

Split type : flat bottom

(different bore diameter type/
large bore diameter type)

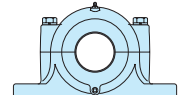

Bore diameter 25 – 160 mm

Split type : large size

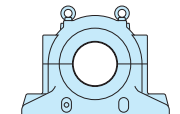

Bore diameter 150 – 360 mm

One-piece type

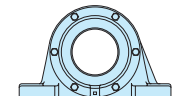

Bore diameter 20 – 170 mm

Table 1 Plummer block types

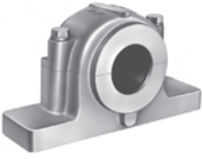
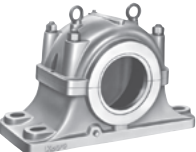
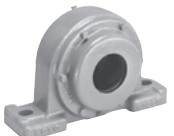
Housing type	Applicable bearing series (plummer block unit series number)		
	Self-aligning ball bearing	Spherical roller bearing	
Split type : standard (SN) 	SN5	12K(SN15), 22K(SN25)	222K(SN225), 232K(SN235)
	SN6	13K(SN16), 23K(SN26)	213K(SN216), 223K(SN226)
	SN33	—	230K(SN233)
	SN34	—	231K(SN234)
	Small-or medium-size ; most general		
Split type : flat bottom (SSN) 	SSN5	12K(SSN15), 22K(SSN25)	222K(SSN225), 232K(SSN235)
	SSN6	13K(SSN16), 23K(SSN26)	213K(SSN216), 223K(SSN226)
	* SSN2	12 (SSN12), 22 (SSN22)	222 (SSN222), 232 (SSN232)
	* SSN3	13 (SSN13), 23 (SSN23)	213 (SSN213), 223 (SSN223)
	** SSN2B	12 (SSN12B), 22 (SSN22B)	222 (SSN222B), 232 (SSN232B)
	** SSN3B	13 (SSN13B), 23 (SSN23B)	213 (SSN213B), 223 (SSN223B)
	<ul style="list-style-type: none"> • Has a flat bottom and is more heavy-duty than the SN type. • Optionally, bolt holes can be provided. 		
Split type : large size (SD) 	SD5	—	222K(SD225)
	SD6	—	223K(SD226)
	SD31L	—	231K(SD231L)
	SD33	—	230K(SD233)
	SD34	—	231K(SD234)
	Large size and most suitable for applications which involve heavy loading.		
One-piece type (V) 	V5	12K(V15), 22K(V25)	222K(V225), 232K(V235)
	V6	13K(V16), 23K(V26)	213K(V216), 223K(V226)
	* V2	12 (V12), 22 (V22)	222 (V222), 232 (V232)
	* V3	13 (V13), 23 (V23)	213 (V213), 223 (V223)
	<ul style="list-style-type: none"> • Has a monolithic housing. • Excellent processing performance and high rigidity. 		

[Notes] * "Different bore diameter type," whose bore diameter of housing or cover differs from side to side. A cylindrical bore bearing is attached to a stepped shaft with a locknut and lockwasher.
 ** "Large bore diameter type," whose housing or cover has a large-diameter bore. A cylindrical bore bearing is attached to the small side of a stepped shaft with a concentric collar.

[Remark] This catalog includes major types of plummer blocks which are boxed in the table above. For other series and special series, refer to separate catalogs.

Table 2 Split plummer block housing dimensional tolerance (JIS B 1551)

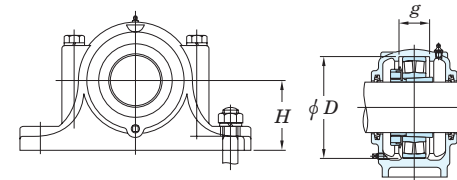

Housing series	Bearing seating bore diameter D	Bearing seating width g	Center height H
SN5, SN6 SN33, SN34 SSN5, SSN6 SSN2, SSN3 SD5, SD6 SD33, SD34 SD31L	H8	H13	h13

Table 3 One-piece plummer block housing dimensional tolerance (BAS 188)

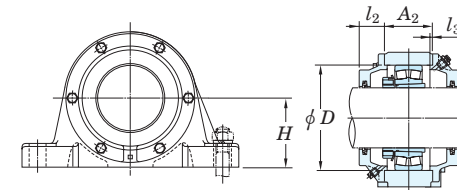

Housing series	Bearing seating bore diameter D	Bearing seating width A_2	Center height H	Cover size l_2	Cover spigot joint height l_3
V5, V6 V2, V3	H7	+0.2 0	h11	±1	0 -0.2

[Remark] The degree of parallelism between the bottom surface and bearing seating center line should be 1/2 000 or less.

Table 4 Stabilizing ring dimensional tolerance

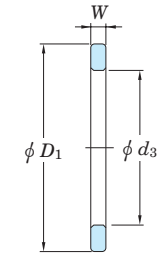

Unit : mm

Outside diameter D_1	Bore diameter d_3	Width W
h12	(SR47 × 5 to SR130 × 12.5) ± 0.8	0
	(SR140 × 8.5 to SR340 × 10) ± 1.2	-0.2

[Remark] Stabilizing ring is installed in bearing seating of plummer block, on the fixed side. It prevents bearing from moving in the axial direction.

Refer to Table 7-3 on pp. A 54 to A 57 for the dimensional tolerance of self-aligning ball bearings and spherical roller bearings which are used with plummer blocks. Refer to Table 7-11 on p. A 70 for tapered bore tolerances.

Plummer blocks
split type, standard
SN 5, 6, 33, 34

d_1 20 ~ (60) mm

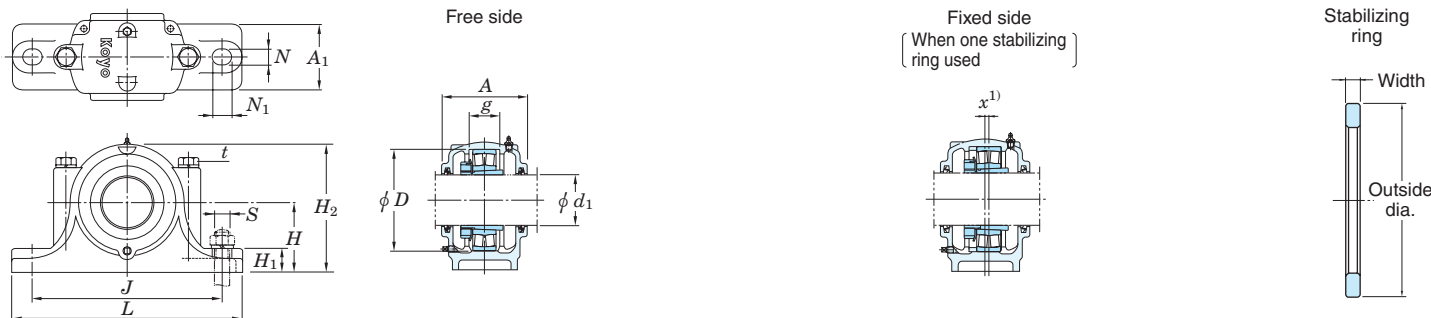

Shaft dia. (mm) d_1	Dimensions (mm)												Bolt size S	Housing No.	(Refer.) Housing mass (kg)	Grease nipple size	Drain plug size	Applicable bearing No.		Applicable adapter ass'y No.	Applicable stabilizing ring		Applicable oil seal No. MZ
	D	H	J	L	A	A ₁	H ₁	H ₂	N	N ₁	g	t Bolt size						Self-aligning ball brg.	Spherical roller brg.		No. Outside dia.×Width	Qty.	
20	52	40	130	165	67	46	22	75	15	20	25	M8	M12	SN505	1.2	R 1/8	R 1/8	1205K 2205K	— 22205RHRK	H205X H305X	SR52×5 SR52×7	2 1	MZ05
	62	50	150	185	80	52	22	90	15	20	34	M8	M12	SN605	1.8	R 1/8	R 1/8	1305K 2305K	—	H305X H2305X	SR62×8.5 SR62×10	2 1	MZ05
25	62	50	150	185	77	52	22	90	15	20	30	M8	M12	SN506	1.9	R 1/8	R 1/8	1206K 2206K	— 22206RHRK	H206X H306X	SR62×7 SR62×10	2 1	MZ06
	72	50	150	185	82	52	22	95	15	20	37	M10	M12	SN606	2.1	R 1/8	R 1/8	1306K 2306K	—	H306X H2306X	SR72×9 SR72×10	2 1	MZ06
30	72	50	150	185	82	52	22	95	15	20	33	M10	M12	SN507	2.3	R 1/8	R 1/8	1207K 2207K	— 22207RHRK	H207X H307X	SR72×8 SR72×10	2 1	MZ07
	80	60	170	205	90	60	25	110	15	20	41	M10	M12	SN607	2.6	R 1/8	R 1/8	1307K 2307K	—	H307X H2307X	SR80×10 SR80×10	2 1	MZ07
35	80	60	170	205	85	60	25	110	15	20	33	M10	M12	SN508	2.4	R 1/8	R 1/8	1208K 2208K	— 22208RHRK	H208X H308X	SR80×7.5 SR80×10	2 1	MZ08
	90	60	170	205	95	60	25	115	15	20	43	M10	M12	SN608	2.8	R 1/8	R 1/8	1308K 2308K	21308RHK 22308RHRK	H308X H2308X	SR90×10 SR90×10	2 1	MZ08
40	85	60	170	205	85	60	25	112	15	20	31	M10	M12	SN509	2.7	R 1/8	R 1/8	1209K 2209K	— 22209RHRK	H209X H309X	SR85×6 SR85×8	2 1	MZ09
	100	70	210	255	105	70	28	130	18	23	46	M12	M16	SN609	4.3	R 1/8	R 1/8	1309K 2309K	21309RHK 22309RHRK	H309X H2309X	SR100×10.5 SR100×10	2 1	MZ09
45	90	60	170	205	90	60	25	115	15	20	33	M10	M12	SN510	3.5	R 1/8	R 1/8	1210K 2210K	— 22210RHRK	H210X H310X	SR90×6.5 SR90×10	2 1	MZ10
	110	70	210	255	115	70	30	135	18	23	50	M12	M16	SN610	4.7	R 1/8	R 1/8	1310K 2310K	21310RHK 22310RHRK	H310X H2310X	SR110×11.5 SR110×10	2 1	MZ10
50	100	70	210	255	95	70	28	130	18	23	33	M12	M16	SN511	3.7	R 1/8	R 1/8	1211K 2211K	— 22211RHRK	H211X H311X	SR100×6 SR100×8	2 1	MZ11
	120	80	230	275	120	80	30	150	18	23	53	M12	M16	SN611	5.8	R 1/8	R 1/8	1311K 2311K	21311RHK 22311RHRK	H311X H2311X	SR120×12 SR120×10	2 1	MZ11
55	110	70	210	255	105	70	30	135	18	23	38	M12	M16	SN512	4.4	R 1/8	R 1/8	1212K 2212K	— 22212RHRK	H212X H312X	SR110×8 SR110×10	2 1	MZ12
	130	80	230	280	125	80	30	155	18	23	56	M12	M16	SN612	6.4	R 1/8	R 1/8	1312K 2312K	21312RHK 22312RHRK	H312X H2312X	SR130×12.5 SR130×10	2 1	MZ12
60	120	80	230	275	110	80	30	150	18	23	43	M12	M16	SN513	5.4	R 1/8	R 1/8	1213K 2213K	— 22213RHRK	H213X H313X	SR120×10 SR120×12	2 1	MZ13

[Note] 1) Dimension x shows the shear between center of bearing and housing when one stabilizing ring is used. The value is 1/2 the width dimension of stabilizing ring. When mounting two stabilizing rings, x becomes equal to 0, since they are mounted to each side of bearing.

[Remark] Housings shown below are equipped with eyebolts.
 SN524~SN532, SN620~SN632, SN3328~SN3338, SN3426~SN3438

Plummer blocks
split type, standard
SN 5, 6, 33, 34

d_1 (60) ~ (110) mm

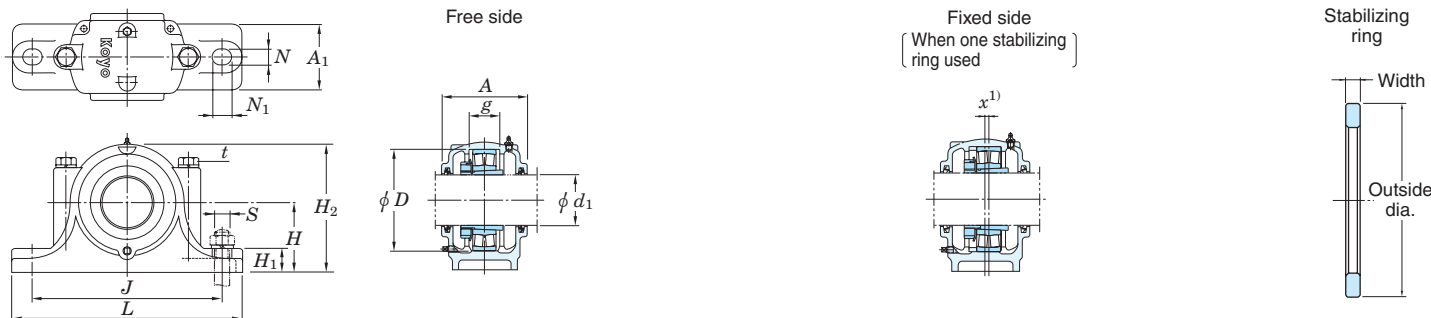

Shaft dia. (mm) d_1	Dimensions (mm)											Bolt size S	Housing No.	(Refer.) Housing mass (kg)	Grease nipple size	Drain plug size	Applicable bearing No.		Applicable adapter ass'y No.	Applicable stabilizing ring		Applicable oil seal No. MZ
	D	H	J	L	A	A_1	H_1	H_2	N	N_1	g						t Bolt size	Self-aligning ball brg.		Spherical roller brg.	No. Outside dia.×Width	
60	140	95	260	315	130	90	32	175	22	27	58	M16	M20	8.6	R 1/8	R 1/8	1313K 2313K	21313RHK 22313RHRK	H313X H2313X	SR140×12.5 SR140×10	2 1	MZ13
	160	100	290	345	140	100	35	195	22	27	65	M16	M20	11.8	R 1/8	R 1/8	1315K 2315K	21315RHK 22315RHRK	H315X H2315X	SR160×14 SR160×10	2 1	MZ15
70	140	95	260	315	120	90	32	175	22	27	43	M16	M20	8.2	R 1/8	R 1/8	1216K 2216K	— 22216RHRK	H216X H316X	SR140×8.5 SR140×10	2 1	MZ16
	170	112	290	345	145	100	35	212	22	27	68	M16	M20	13.6	R 1/8	R 1/8	1316K 2316K	21316RHK 22316RHRK	H316X H2316X	SR170×14.5 SR170×10	2 1	MZ16
75	150	95	260	320	125	90	32	185	22	27	46	M16	M20	9.3	R 1/8	R 1/8	1217K 2217K	— 22217RHRK	H217X H317X	SR150×9 SR150×10	2 1	MZ17
	180	112	320	380	155	110	40	223	26	32	70	M20	M24	16.8	R 1/8	R 1/8	1317K 2317K	21317RHK 22317RHRK	H317X H2317X	SR180×14.5 SR180×10	2 1	MZ17
80	160	100	290	345	145	100	35	195	22	27	62.4	M16	M20	12	R 1/8	R 1/8	1218K 2218K	— 22218RHRK 23218RHK	H218X H318X H2318X	SR160×16.2 SR160×11.2 SR160×10	2 2 1	MZ18
	190	112	320	380	160	110	40	230	26	32	74	M20	M24	21	R 1/4	R 1/4	1318K 2318K	— 22318RHRK	H318X H2318X	SR190×15.5 SR190×10	2 1	MZ18
85	170	112	290	345	140	100	35	210	22	27	53	M16	M20	13	R 1/8	R 1/8	1219K 2219K	— 22219RHRK	H219X H319X	SR170×10.5 SR170×10	2 1	MZ19
	200	125	350	410	170	120	45	250	26	32	77	M20	M24	23	R 1/4	R 1/4	1319K 2319K	— 22319RHRK	H319X H2319X	SR200×16 SR200×10	2 1	MZ19
90	180	112	320	380	160	110	40	223	26	32	70.3	M20	M24	17	R 1/4	R 1/4	1220K 2220K	— 22220RHRK 23220RHK	H220X H320X H2320X	SR180×18.1 SR180×12.1 SR180×10	2 2 1	MZ20
	215	140	350	410	175	120	45	270	26	32	83	M20	M24	31	R 1/4	R 1/4	1320K 2320K	— 22320RHRK	H320X H2320X	SR215×18 SR215×10	2 1	MZ20
100	180	112	320	380	155	110	40	223	26	32	66	M20	M24	20	R 1/4	R 1/4	—	23122RHK	H3122X	SR180×10	1	MZ22
	200	125	350	410	175	120	45	245	26	32	80	M20	M24	20	R 1/4	R 1/4	1222K 2222K	— 22222RHRK 23222RHK	H222X H322X H2322X	SR200×21 SR200×13.5 SR200×10	2 2 1	MZ22
	240	150	390	450	190	130	50	300	28	36	90	M24	M24	38	R 1/4	R 1/4	1322K 2322K	— 22322RHRK	H322X H2322X	SR240×20 SR240×10	2 1	MZ22
110	180	112	320	380	150	110	40	223	26	32	56	M20	M24	19	R 1/4	R 1/4	—	23024RHK	H3024	SR180×10	1	MZ24

[Note] 1) Dimension x shows the shear between center of bearing and housing when one stabilizing ring is used. The value is 1/2 the width dimension of stabilizing ring.
 When mounting two stabilizing rings, x becomes equal to 0, since they are mounted to each side of bearing.

[Remark] Housings shown below are equipped with eyebolts.
 SN524~SN532, SN620~SN632, SN3328~SN3338, SN3426~SN3438

Plummer blocks
split type, standard
SN 5, 6, 33, 34

d_1 (110) ~ (140) mm

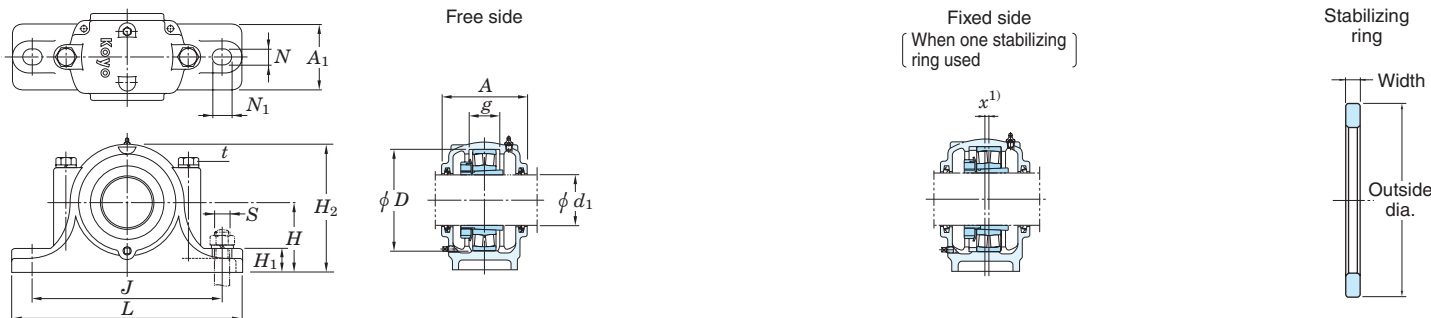

Shaft dia. (mm) d_1	Dimensions (mm)													Bolt size S	Housing No.	(Refer.) Housing mass (kg)	Grease nipple size	Drain plug size	Applicable bearing No.		Applicable adapter ass'y No.	Applicable stabilizing ring		Applicable oil seal No. MZ
	D	H	J	L	A	A_1	H_1	H_2	N	N_1	g	t Bolt size	Self-aligning ball brg.						Spherical roller brg.	No. Outside dia.×Width		Qty.		
110	200	125	350	410	165	120	45	245	26	32	72	M20	M24	SN3424	22	R 1/4	R 1/4	— 23124RHK	H3124	SR200×10	1	MZ24		
	215	140	350	410	185	120	45	270	26	32	86	M20	M24	SN524	23	R 1/4	R 1/4	— 22224RHRK 23224RHK	H3124 H2324	SR215×14 SR215×10	2 1	MZ24		
	260	160	450	530	200	160	60	320	33	42	96	M24	M30	SN624	48	R 1/4	R 1/4	— 22324RHRK	H2324	SR260×10	1	MZ24		
115	200	125	350	410	160	120	45	245	26	32	62	M20	M24	SN3326	21	R 1/4	R 1/4	— 23026RHK	H3026	SR200×10	1	MZ26		
	210	140	350	410	170	120	45	270	26	32	74	M20	M24	SN3426	29	R 1/4	R 1/4	— 23126RHK	H3126	SR210×10	1	MZ26		
	230	150	380	445	190	130	50	290	28	36	90	M24	M24	SN526	33	R 1/4	R 1/4	— 22226RHRK 23226RHK	H3126 H2326	SR230×13 SR230×10	2 1	MZ26		
	280	170	470	550	210	160	60	340	33	42	103	M24	M30	SN626	78	R 1/4	R 1/4	— 22326RHRK	H2326	SR280×10	1	MZ26		
125	210	140	350	410	170	120	45	270	26	32	63	M20	M24	SN3328	28	R 1/4	R 1/4	— 23028RHK	H3028	SR210×10	1	MZ28		
	225	150	380	445	180	130	50	290	28	36	78	M24	M24	SN3428	36	R 1/4	R 1/4	— 23128RHK	H3128	SR225×10	1	MZ28		
	250	150	420	500	205	150	50	305	33	42	98	M24	M30	SN528	40	R 1/4	R 1/4	— 22228RHRK 23228RHK	H3128 H2328	SR250×15 SR250×10	2 1	MZ28		
	300	180	520	610	235	170	65	365	35	45	112	M30	M30	SN628	97	R 1/4	R 1/4	— 22328RK	H2328	SR300×10	1	MZ28		
135	225	150	380	445	175	130	50	290	28	36	66	M24	M24	SN3330	32	R 1/4	R 1/4	— 23030RHK	H3030	SR225×10	1	MZ30		
	250	150	420	500	200	150	50	305	33	42	90	M24	M30	SN3430	42	R 1/4	R 1/4	— 23130RHK	H3130	SR250×10	1	MZ30		
	270	160	450	530	220	160	60	325	33	42	106	M24	M30	SN530	45	R 1/4	R 1/4	— 22230RHRK 23230RHK	H3130 H2330	SR270×16.5 SR270×10	2 1	MZ30		
	320	190	560	650	245	180	65	385	35	45	118	M30	M30	SN630	110	R 1/4	R 1/4	— 22330RK	H2330	SR320×10	1	MZ30		
140	240	150	390	450	190	130	50	300	28	36	70	M24	M24	SN3332	36	R 1/4	R 1/4	— 23032RHK	H3032	SR240×10	1	MZ32		
	270	160	450	530	215	160	60	325	33	42	96	M24	M30	SN3432	53	R 1/4	R 1/4	— 23132RHK	H3132	SR270×10	1	MZ32		

[Note] 1) Dimension x shows the shear between center of bearing and housing when one stabilizing ring is used. The value is 1/2 the width dimension of stabilizing ring. When mounting two stabilizing rings, x becomes equal to 0, since they are mounted to each side of bearing.

[Remark] Housings shown below are equipped with eyebolts.
 SN524~SN532, SN620~SN632, SN3328~SN3338, SN3426~SN3438

Plummer blocks
split type, standard

SN 5, 6, 33, 34

d_1 (140) ~ 170 mm

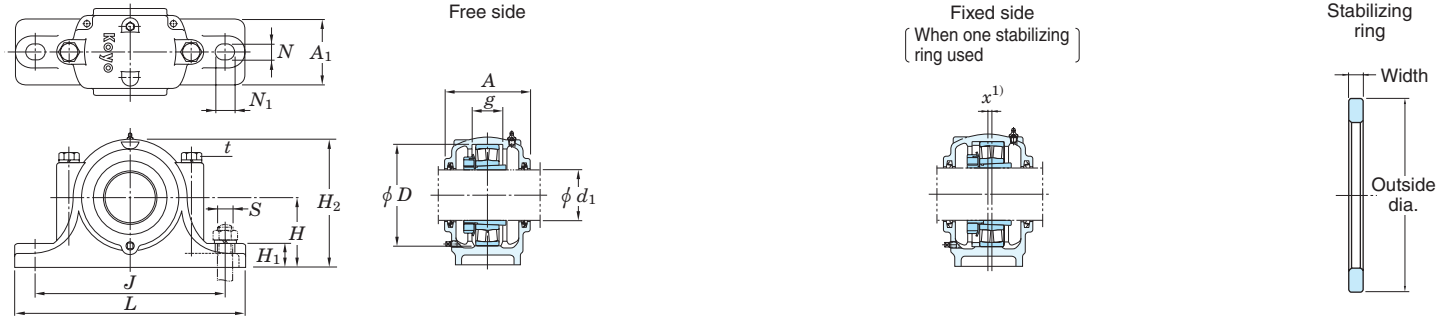

Shaft dia. (mm) d_1	Dimensions (mm)												Bolt size S	Housing No.	(Refer.) Housing mass (kg)	Grease nipple size	Drain plug size	Applicable bearing No.		Applicable adapter ass'y No.	Applicable stabilizing ring		Applicable oil seal No. MZ
	D	H	J	L	A	A_1	H_1	H_2	N	N_1	g	t Bolt size						Self-aligning ball brg.	Spherical roller brg.		No. Outside dia.×Width	Qty.	
140	290	170	470	550	235	160	60	345	33	42	114	M24	M30	SN532	51	R 1/4	R 1/4	—	22232RK 23232RK	H3132 H2332	SR290×17 SR290×10	2 1	MZ32
	340	200	580	680	255	190	70	405	42	50	124	M30	M36	SN632	120	R 1/4	R 1/4	—	22332RK	H2332	SR340×10	1	MZ32
150	260	160	450	530	200	160	60	320	33	42	77	M24	M30	SN3334	45	R 1/4	R 1/4	—	23034RHK	H3034	SR260×10	1	MZ34
	280	170	470	550	220	160	60	340	33	42	98	M24	M30	SN3434	61	R 1/4	R 1/4	—	23134RHK	H3134	SR280×10	1	MZ34
160	280	170	470	550	210	160	60	340	33	42	84	M24	M30	SN3336	57	R 1/4	R 1/4	—	23036RHK	H3036	SR280×10	1	MZ36
	300	180	520	610	230	170	65	365	35	45	106	M30	M30	SN3436	80	R 1/4	R 1/4	—	23136RK	H3136	SR300×10	1	MZ36
170	290	170	470	550	210	160	60	345	33	42	85	M24	M30	SN3338	59	R 1/4	R 1/4	—	23038RK	H3038	SR290×10	1	MZ38
	320	190	560	650	240	180	65	385	35	45	114	M30	M30	SN3438	95	R 1/4	R 1/4	—	23138RK	H3138	SR320×10	1	MZ38

[Note] 1) Dimension x shows the shear between center of bearing and housing when one stabilizing ring is used. The value is 1/2 the width dimension of stabilizing ring. When mounting two stabilizing rings, x becomes equal to 0, since they are mounted to each side of bearing.

[Remark] Housings shown below are equipped with eyebolts. SN524~SN532, SN620~SN632, SN3328~SN3338, SN3426~SN3438

Plummer blocks
split type, flat bottom
SSN 5, 6

d_1 20 ~ (60) mm

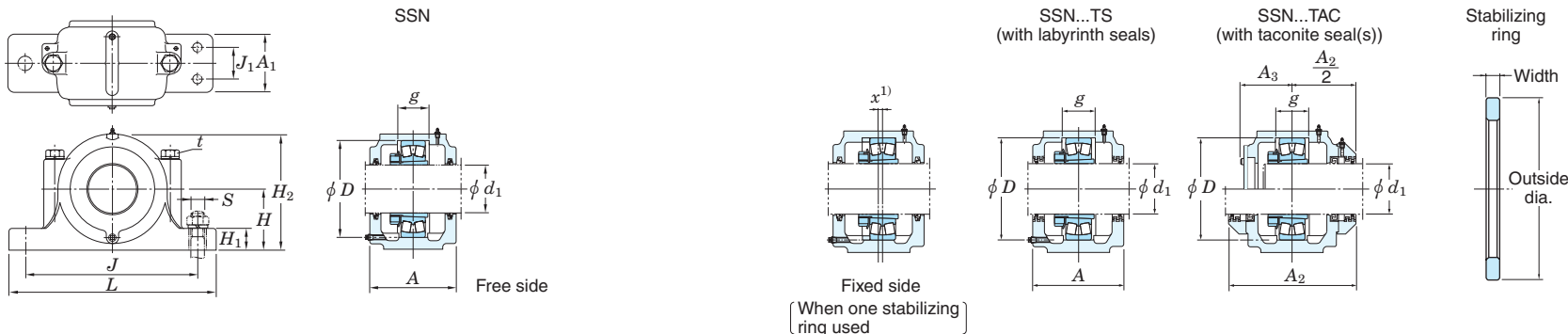

Shaft dia. (mm) d_1	Dimensions (mm)												Bolt size		Housing No.		(Refer.) Housing mass (kg)	Grease nipple size	Drain plug size	Applicable bearing No.		Applicable adapter ass'y No.	Applicable stabilizing ring		Applicable oil seal No. MZ
	D	H	J	J ₁	L	A	A ₁	A ₂	A ₃	H ₁	H ₂	g	t Bolt size	S (Two) (Four)						Self-aligning ball brg.	Spherical roller brg.		Outside dia.×Width	Qty.	
20	52	40	130	25	165	67	46	—	—	22	75	25	M8	M12	M10	SSN505	1.8	R 1/8	R 1/8	1205K 2205K	— 22205RHRK	H205X H305X	SR52×5 SR52×7	2 1	MZ05
	62	50	150	25	185	80	52	—	—	22	90	34	M8	M12	M10	SSN605	2.6	R 1/8	R 1/8	1305K 2305K	—	H305X H2305X	SR62×8.5 SR62×10	2 1	MZ05
25	62	50	150	25	185	77	52	—	—	22	90	30	M8	M12	M10	SSN506	2.7	R 1/8	R 1/8	1206K 2206K	— 22206RHRK	H206X H306X	SR62×7 SR62×10	2 1	MZ06
	72	50	150	25	185	82	52	—	—	22	95	37	M10	M12	M10	SSN606	2.8	R 1/8	R 1/8	1306K 2306K	—	H306X H2306X	SR72×9 SR72×10	2 1	MZ06
30	72	50	150	25	185	82	52	—	—	22	95	33	M10	M12	M10	SSN507	3.0	R 1/8	R 1/8	1207K 2207K	— 22207RHRK	H207X H307X	SR72×8 SR72×10	2 1	MZ07
	80	60	170	30	205	90	60	—	—	25	110	41	M10	M12	M10	SSN607	3.8	R 1/8	R 1/8	1307K 2307K	—	H307X H2307X	SR80×10 SR80×10	2 1	MZ07
35	80	60	170	30	205	85	60	—	—	25	110	33	M10	M12	M10	SSN508	3.8	R 1/8	R 1/8	1208K 2208K	— 22208RHRK	H208X H308X	SR80×7.5 SR80×10	2 1	MZ08
	90	60	170	30	205	95	60	—	—	25	115	43	M10	M12	M10	SSN608	3.9	R 1/8	R 1/8	1308K 2308K	21308RHK 22308RHRK	H308X H2308X	SR90×10 SR90×10	2 1	MZ08
40	85	60	170	30	205	85	60	—	—	25	112	31	M10	M12	M10	SSN509	4.3	R 1/8	R 1/8	1209K 2209K	— 22209RHRK	H209X H309X	SR85×6 SR85×8	2 1	MZ09
	100	70	210	35	255	105	70	—	—	28	130	46	M12	M16	M12	SSN609	6.2	R 1/8	R 1/8	1309K 2309K	21309RHK 22309RHRK	H309X H2309X	SR100×10.5 SR100×10	2 1	MZ09
45	90	60	170	30	205	90	60	—	—	25	115	33	M10	M12	M10	SSN510	5.2	R 1/8	R 1/8	1210K 2210K	— 22210RHRK	H210X H310X	SR90×6.5 SR90×10	2 1	MZ10
	110	70	210	35	255	115	70	—	—	30	135	50	M12	M16	M12	SSN610	6.5	R 1/8	R 1/8	1310K 2310K	21310RHK 22310RHRK	H310X H2310X	SR110×11.5 SR110×10	2 1	MZ10
50	100	70	210	35	255	95	70	160	57	28	130	33	M12	M16	M12	SSN511	5.5	R 1/8	R 1/8	1211K 2211K	— 22211RHRK	H211X H311X	SR100×6 SR100×8	2 1	MZ11
	120	80	230	40	275	120	80	185	70	30	150	53	M12	M16	M12	SSN611	8.5	R 1/8	R 1/8	1311K 2311K	21311RHK 22311RHRK	H311X H2311X	SR120×12 SR120×10	2 1	MZ11
55	110	70	210	35	255	105	70	164	62	30	135	38	M12	M16	M12	SSN512	6.3	R 1/8	R 1/8	1212K 2212K	— 22212RHRK	H212X H312X	SR110×8 SR110×10	2 1	MZ12
	130	80	230	40	280	125	80	184	72	30	155	56	M12	M16	M12	SSN612	8.9	R 1/8	R 1/8	1312K 2312K	21312RHK 22312RHRK	H312X H2312X	SR130×12.5 SR130×10	2 1	MZ12
60	120	80	230	40	275	110	80	168	65	30	150	43	M12	M16	M12	SSN513	6.8	R 1/8	R 1/8	1213K 2213K	— 22213RHRK	H213X H313X	SR120×10 SR120×12	2 1	MZ13

[Note] 1) Dimension x shows the shear between center of bearing and housing when one stabilizing ring is used. The value is 1/2 the width dimension of stabilizing ring.
 When mounting two stabilizing rings, x becomes equal to 0, since they are mounted to each side of bearing.

[Remarks] 1) Use of labyrinth or taconite seals are indicated by TS or TAC suffixed to housing numbers.
 2) Housings shown below are equipped with eyebolts.
 SSN524~SSN532, SSN618~SSN632

Plummer blocks
split type, flat bottom
SSN 5, 6

d_1 (60) ~ 110 mm

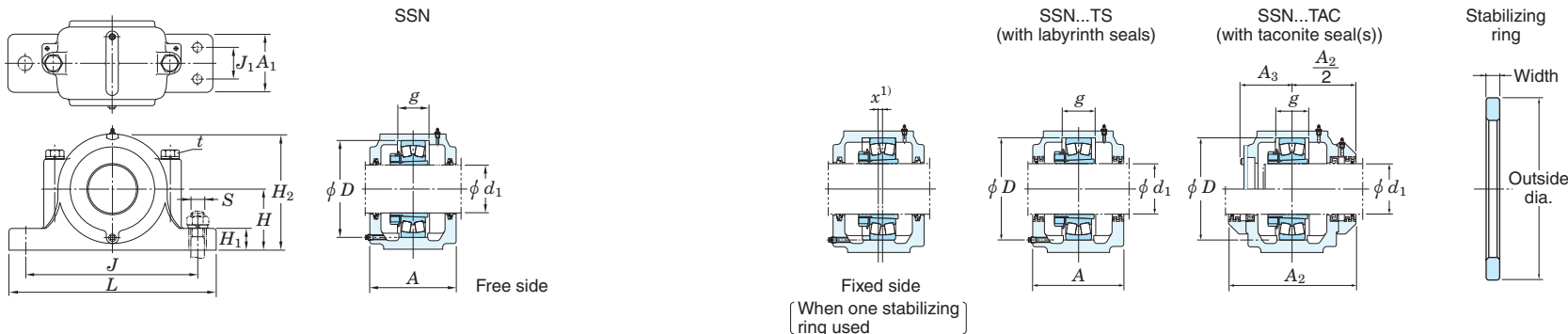

Shaft dia. (mm) d_1	Dimensions (mm)												Bolt size		Housing No.		(Refer.) Housing mass (kg)	Grease nipple size	Drain plug size	Applicable bearing No.		Applicable adapter ass'y No.	Applicable stabilizing ring		Applicable oil seal No. MZ	
	D	H	J	J_1	L	A	A_1	A_2	A_3	H_1	H_2	g	t Bolt size	S (Two) (Four)						Self-aligning ball brg.	Spherical roller brg.		Outside dia.×Width	Qty.		
60	140	95	260	50	315	130	90	188	75	32	175	58	M16	M20	M16	SSN613		12.9	R 1/8	R 1/8	1313K	21313RHK	H313X	SR140×12.5	2	MZ13
																							H2313X	SR140×10	1	
65	130	80	230	40	280	115	80	172	67	30	155	41	M12	M16	M12	SSN515		7.9	R 1/8	R 1/8	1215K	—	H215X	SR130×8	2	MZ15
																							H315X	SR130×10	1	
65	160	100	290	50	345	140	100	197	80	35	195	65	M16	M20	M16	SSN615		16.5	R 1/8	R 1/8	1315K	21315RHK	H315X	SR160×14	2	MZ15
																							H2315X	SR160×10	1	
70	140	95	260	50	315	120	90	190	70	32	175	43	M16	M20	M16	SSN516		12	R 1/8	R 1/8	1216K	—	H216X	SR140×8.5	2	MZ16
																							H316X	SR140×10	1	
70	170	112	290	50	345	145	100	215	83	35	212	68	M16	M20	M16	SSN616		18	R 1/8	R 1/8	1316K	21316RHK	H316X	SR170×14.5	2	MZ16
																							H2316X	SR170×10	1	
75	150	95	260	50	320	125	90	194	75	32	185	46	M16	M20	M16	SSN517		13	R 1/8	R 1/8	1217K	—	H217X	SR150×9	2	MZ17
																							H317X	SR150×10	1	
75	180	112	320	60	380	155	110	224	90	40	223	70	M20	M24	M20	SSN617		25.8	R 1/8	R 1/8	1317K	21317RHK	H317X	SR180×14.5	2	MZ17
																							H2317X	SR180×10	1	
80	160	100	290	50	345	145	100	214	85	35	195	62.4	M16	M20	M16	SSN518		17	R 1/8	R 1/8	1218K	—	H218X	SR160×16.2	2	MZ18
																							H318X	SR160×11.2	2	
80	190	112	320	60	380	160	110	229	93	40	230	74	M20	M24	M20	SSN618		28	R 1/4	R 1/4	—	23218RHK	H2318X	SR160×10	1	MZ18
																							H318X	SR190×15.5	2	
80																				H2318X	SR190×10	1				
																				H318X	SR190×10	1				
85	170	112	290	50	345	140	100	214	85	35	210	53	M16	M20	M16	SSN519		18	R 1/8	R 1/8	1219K	—	H219X	SR170×10.5	2	MZ19
																							H319X	SR170×10	1	
85	200	125	350	70	410	170	120	235	98	45	250	77	M20	M24	M20	SSN619		31	R 1/4	R 1/4	1319K	—	H319X	SR200×16	2	MZ19
																							H2319X	SR200×10	1	
90	180	112	320	60	380	160	110	220	92	40	223	70.3	M20	M24	M16	SSN520		24	R 1/4	R 1/4	1220K	—	H220X	SR180×18.1	2	MZ20
																							H320X	SR180×12.1	2	
90	215	140	350	70	410	175	120	235	100	45	270	83	M20	M24	M20	SSN620		41	R 1/4	R 1/4	—	23220RHK	H2320X	SR180×10	1	MZ20
																							H320X	SR215×18	2	
90																				H2320X	SR215×10	1				
																				H320X	SR215×10	1				
100	200	125	350	70	410	175	120	240	100	45	245	80	M20	M24	M16	SSN522		28	R 1/4	R 1/4	1222K	—	H222X	SR200×21	2	MZ22
																							H322X	SR200×13.5	2	
100	240	150	390	70	450	190	130	255	108	50	300	90	M24	M24	M24	SSN622		51	R 1/4	R 1/4	—	23222RHK	H2322X	SR200×10	1	MZ22
																							H322X	SR240×20	2	
100																				H2322X	SR240×10	1				
																				H322X	SR240×10	1				
110	215	140	350	70	410	185	120	254	110	45	270	86	M20	M24	M16	SSN524		33	R 1/4	R 1/4	—	22224RHK	H3124	SR215×14	2	MZ24
																							H2324	SR215×10	1	
110	260	160	450	90	530	200	160	269	118	60	320	96	M24	M30	M24	SSN624		63	R 1/4	R 1/4	—	22324RHK	H2324	SR260×10	1	MZ24

[Note] 1) Dimension x shows the shear between center of bearing and housing when one stabilizing ring is used. The value is 1/2 the width dimension of stabilizing ring.
When mounting two stabilizing rings, x becomes equal to 0, since they are mounted to each side of bearing.

[Remarks] 1) Use of labyrinth or taconite seals are indicated by TS or TAC suffixed to housing numbers.
2) Housings shown below are equipped with eyebolts.
SSN524~SSN532, SSN618~SSN632

Plummer blocks
split type, flat bottom
SSN 5, 6

d_1 115 ~ 140 mm

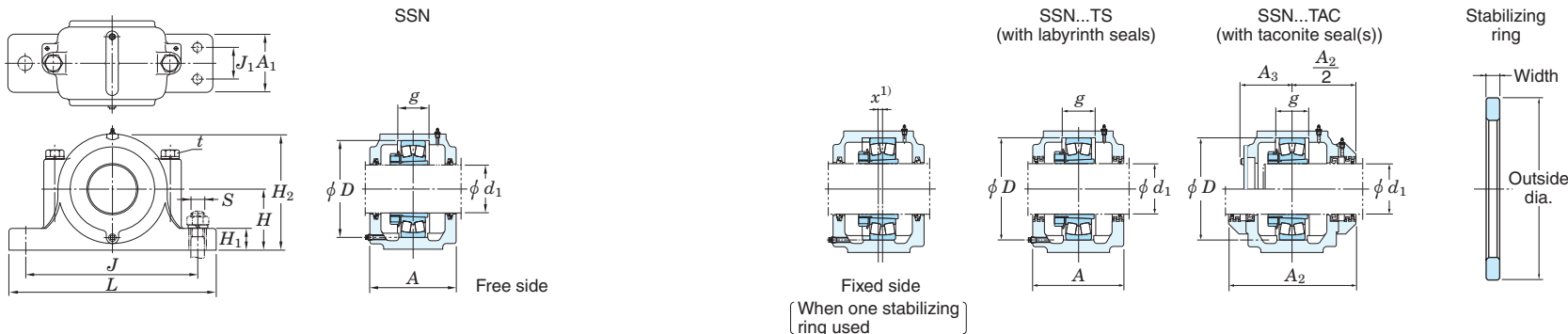

Shaft dia. (mm)	Dimensions (mm)												Bolt size		Housing No.	(Refer.) Housing mass (kg)	Grease nipple size	Drain plug size	Applicable bearing No.		Applicable adapter ass'y No.	Applicable stabilizing ring		Applicable oil seal No.	
	d_1	D	H	J	J_1	L	A	A_1	A_2	A_3	H_1	H_2	g	t Bolt size					S (Two) (Four)	Self-aligning ball brg.		Spherical roller brg.	Outside dia.×Width		Qty.
115	230	150	380	70	445	190	130	260	112	50	290	90	M24	M24	M20	SSN526	45	R 1/4	R 1/4	—	22226RHRK 23226RHK	H3126 H2326	SR230×13 SR230×10	2 1	MZ26
	280	170	470	90	550	210	160	280	122	60	340	103	M24	M30	M24	SSN626	96	R 1/4	R 1/4	—	22326RHRK	H2326	SR280×10	1	MZ26
125	250	150	420	80	500	205	150	274	120	50	305	98	M24	M30	M24	SSN528	54	R 1/4	R 1/4	—	22228RHRK 23228RHK	H3128 H2328	SR250×15 SR250×10	2 1	MZ28
	300	180	520	100	610	235	170	304	135	65	365	112	M30	M30	M24	SSN628	117	R 1/4	R 1/4	—	22328RK	H2328	SR300×10	1	MZ28
135	270	160	450	90	530	220	160	280	127	60	325	106	M24	M30	M24	SSN530	60	R 1/4	R 1/4	—	22230RHRK 23230RHK	H3130 H2330	SR270×16.5 SR270×10	2 1	MZ30
	320	190	560	110	650	245	180	310	140	65	385	118	M30	M30	M24	SSN630	132	R 1/4	R 1/4	—	22330RK	H2330	SR320×10	1	MZ30
140	290	170	470	90	550	235	160	300	135	60	345	114	M24	M30	M24	SSN532	69	R 1/4	R 1/4	—	22232RK 23232RK	H3132 H2332	SR290×17 SR290×10	2 1	MZ32
	340	200	580	110	680	255	190	320	145	70	405	124	M30	M36	M30	SSN632	145	R 1/4	R 1/4	—	22332RK	H2332	SR340×10	1	MZ32

[Note] 1) Dimension x shows the shear between center of bearing and housing when one stabilizing ring is used. The value is 1/2 the width dimension of stabilizing ring.
 When mounting two stabilizing rings, x becomes equal to 0, since they are mounted to each side of bearing.

[Remarks] 1) Use of labyrinth or taconite seals are indicated by TS or TAC suffixed to housing numbers.
 2) Housings shown below are equipped with eyebolts.
 SSN524~SSN532, SSN618~SSN632

Plummer blocks
split type, flat bottom
different bore type
SSN 2, 3
large bore type
SSN 2B, 3B
 d_1 20 ~ (60) mm

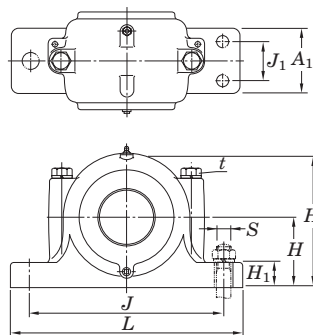

SSN 2, 3
 Different bore type
 (locknut locking)

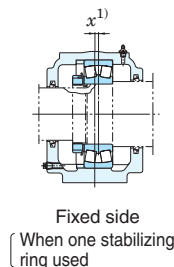
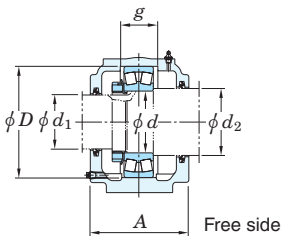

SSN 2B, 3B
 Large bore type
 (concentric collar locking)

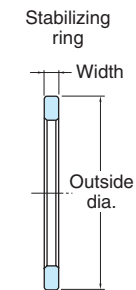
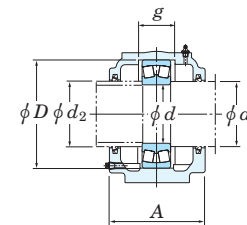

Shaft diameter (mm)	Dimensions (mm)												Bolt size		Housing No.	(Refer.) Housing mass (kg)	Grease nipple size	Drain plug size	Applicable bearing No.		Applicable stabilizing ring		Applicable oil seal No.		
	d_1	d	$d_2^{2)}$	D	H	J	J_1	L	A	A_1	H_1	H_2	g	t Bolt size					S (Two) (Four)	Self-aligning ball brg.	Spherical roller brg.	No. Outside dia.×Width	Qty.	d_1 side	d_2 side
20	25	*30	52	40	130	25	165	67	46	22	75	25	M8	M12	M10	SSN205	1.8	R 1/8	R 1/8	1205 2205	— 22205RHR	SR52×5 SR52×7	2 1	MZ05	MZ07
	25	30	62	50	150	25	185	80	52	22	90	34	M8	M12	M10	SSN305	2.6	R 1/8	R 1/8	1305 2305	—	SR62×8.5 SR62×10	2 1	MZ05	MZ07
25	30	*35	62	50	150	25	185	77	52	22	90	30	M8	M12	M10	SSN206	2.7	R 1/8	R 1/8	1206 2206	— 22206RHR	SR62×7 SR62×10	2 1	MZ06	MZ08
	30	35	72	50	150	25	185	82	52	22	95	37	M10	M12	M10	SSN306	2.8	R 1/8	R 1/8	1306 2306	—	SR72×9 SR72×10	2 1	MZ06	MZ08
30	35	45	72	50	150	25	185	82	52	22	95	33	M10	M12	M10	SSN207	3.0	R 1/8	R 1/8	1207 2207	— 22207RHR	SR72×8 SR72×10	2 1	MZ07	MZ10
	35	45	80	60	170	30	205	90	60	25	110	41	M10	M12	M10	SSN307	3.8	R 1/8	R 1/8	1307 2307	—	SR80×10 SR80×10	2 1	MZ07	MZ10
35	40	50	80	60	170	30	205	85	60	25	110	33	M10	M12	M10	SSN208	3.8	R 1/8	R 1/8	1208 2208	— 22208RHR	SR80×7.5 SR80×10	2 1	MZ08	MZ11
	40	50	90	60	170	30	205	95	60	25	115	43	M10	M12	M10	SSN308	3.9	R 1/8	R 1/8	1308 2308	21308RH 22308RHR	SR90×10 SR90×10	2 1	MZ08	MZ11
40	45	55	85	60	170	30	205	85	60	25	112	31	M10	M12	M10	SSN209	4.3	R 1/8	R 1/8	1209 2209	— 22209RHR	SR85×6 SR85×8	2 1	MZ09	MZ12
	45	55	100	70	210	35	255	105	70	28	130	46	M12	M16	M12	SSN309	6.2	R 1/8	R 1/8	1309 2309	21309RH 22309RHR	SR100×10.5 SR100×10	2 1	MZ09	MZ12
45	50	60	90	60	170	30	205	90	60	25	115	33	M10	M12	M10	SSN210	5.2	R 1/8	R 1/8	1210 2210	— 22210RHR	SR90×6.5 SR90×10	2 1	MZ10	MZ13
	50	60	110	70	210	35	255	115	70	30	135	50	M12	M16	M12	SSN310	6.5	R 1/8	R 1/8	1310 2310	21310RH 22310RHR	SR110×11.5 SR110×10	2 1	MZ10	MZ13
50	55	65	100	70	210	35	255	95	70	28	130	33	M12	M16	M12	SSN211	5.5	R 1/8	R 1/8	1211 2211	— 22211RHR	SR100×6 SR100×8	2 1	MZ11	MZ15
	55	65	120	80	230	40	275	120	80	30	150	53	M12	M16	M12	SSN311	8.5	R 1/8	R 1/8	1311 2311	21311RH 22311RHR	SR120×12 SR120×10	2 1	MZ11	MZ15
55	60	70	110	70	210	35	255	105	70	30	135	38	M12	M16	M12	SSN212	6.3	R 1/8	R 1/8	1212 2212	— 22212RHR	SR110×8 SR110×10	2 1	MZ12	MZ16
	60	*70	130	80	230	40	280	125	80	30	155	56	M12	M16	M12	SSN312	8.9	R 1/8	R 1/8	1312 2312	21312RH 22312RHR	SR130×12.5 SR130×10	2 1	MZ12	MZ16
60	65	75	120	80	230	40	275	110	80	30	150	43	M12	M16	M12	SSN213	6.8	R 1/8	R 1/8	1213 2213	— 22213RHR	SR120×10 SR120×12	2 1	MZ13	MZ17

[Notes] 1) Dimension x shows the shear between center of bearing and housing when one stabilizing ring is used. The value is 1/2 the width dimension of stabilizing ring.
 When mounting two stabilizing rings, x becomes equal to 0, since they are mounted to each side of bearing.
 2) If bearing of shaft diameter marked with * (shoulder diameter) receives large axial load, the use of spacers is recommended.

[Remarks] 1) Large bore diameter types (concentric collar locking) are identified by B suffixed to housing numbers.
 2) Housings shown below are equipped with eyebolts.
 SSN224~SSN232, SSN318~SSN332

Plummer blocks
split type, flat bottom
different bore type
SSN 2, 3
large bore type
SSN 2B, 3B

d_1 (60) ~ (105) mm

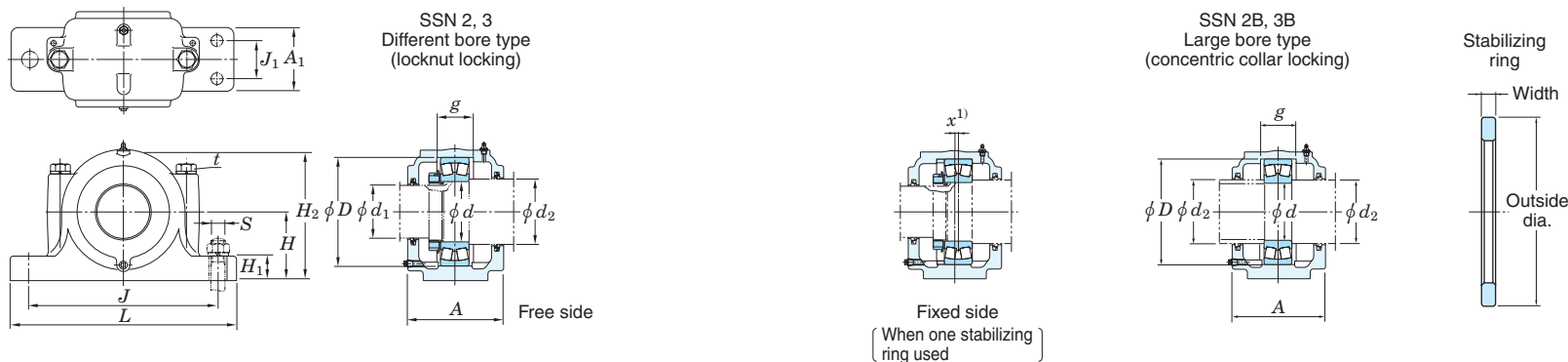

Shaft diameter (mm)			Dimensions (mm)										Bolt size		Housing No.	(Refer.) Housing mass (kg)	Grease nipple size	Drain plug size	Applicable bearing No.		Applicable stabilizing ring No.		Applicable oil seal No.		
d_1	d	$d_2^{2)}$	D	H	J	J_1	L	A	A_1	H_1	H_2	g	t Bolt size	S (Two) (Four)					Self-aligning ball brg.	Spherical roller brg.	Outside dia.×Width	Qty.	d_1 side	d_2 side	
60	65	*75	140	95	260	50	315	130	90	32	175	58	M16	M20	M16	SSN313	12.9	R 1/8	R 1/8	1313 2313	21313RH 22313RHR	SR140×12.5 SR140×10	2 1	MZ13	MZ17
	70	80	125	80	230	40	275	115	80	30	155	44	M12	M16	M12	SSN214	7.5	R 1/8	R 1/8	1214 2214	— 22214RHR	SR125×10 SR125×13	2 1	MZ15	MZ18
65	70	*80	150	95	260	50	320	130	90	32	185	61	M16	M20	M16	SSN314	15	R 1/8	R 1/8	1314 2314	21314RH 22314RHR	SR150×13 SR150×10	2 1	MZ15	MZ18
	75	85	130	80	230	40	280	115	80	30	155	41	M12	M16	M12	SSN215	7.9	R 1/8	R 1/8	1215 2215	— 22215RHR	SR130×8 SR130×10	2 1	MZ16	MZ19
70	75	*85	160	100	290	50	345	140	100	35	195	65	M16	M20	M16	SSN315	16.5	R 1/8	R 1/8	1315 2315	21315RH 22315RHR	SR160×14 SR160×10	2 1	MZ16	MZ19
	80	90	140	95	260	50	315	120	90	32	175	43	M16	M20	M16	SSN216	12	R 1/8	R 1/8	1216 2216	— 22216RHR	SR140×8.5 SR140×10	2 1	MZ17	MZ20
75	80	*90	170	112	290	50	345	145	100	35	212	68	M16	M20	M16	SSN316	18	R 1/8	R 1/8	1316 2316	21316RH 22316RHR	SR170×14.5 SR170×10	2 1	MZ17	MZ20
	85	95	150	95	260	50	320	125	90	32	185	46	M16	M20	M16	SSN217	13	R 1/8	R 1/8	1217 2217	— 22217RHR	SR150×9 SR150×10	2 1	MZ18	MZ21
80	85	95	180	112	320	60	380	155	110	40	223	70	M20	M24	M20	SSN317	25.8	R 1/8	R 1/8	1317 2317	21317RH 22317RHR	SR180×14.5 SR180×10	2 1	MZ18	MZ21
	90	100	160	100	290	50	345	145	100	35	195	62.4	M16	M20	M16	SSN218	17	R 1/8	R 1/8	1218 2218	— 22218RHR	SR160×16.2 SR160×11.2 SR160×10	2 2 1	MZ19	MZ22
85	90	105	190	112	320	60	380	160	110	40	230	74	M20	M24	M20	SSN318	28	R 1/4	R 1/4	1318 2318	— 22318RHR	SR190×15.5 SR190×10	2 1	MZ19	MZ23
	95	110	170	112	290	50	345	140	100	35	210	53	M16	M20	M16	SSN219	18	R 1/8	R 1/8	1219 2219	— 22219RHR	SR170×10.5 SR170×10	2 1	MZ20	MZ24
90	95	110	200	125	350	70	410	170	120	45	250	77	M20	M24	M20	SSN319	31	R 1/4	R 1/4	1319 2319	— 22319RHR	SR200×16 SR200×10	2 1	MZ20	MZ24
	100	115	180	112	320	60	380	160	110	40	223	70.3	M20	M24	M16	SSN220	24	R 1/4	R 1/4	1220 2220	— 22220RHR	SR180×18.1 SR180×12.1 SR180×10	2 2 1	MZ21	MZ26
95	100	115	215	140	350	70	410	175	120	45	270	83	M20	M24	M20	SSN320	41	R 1/4	R 1/4	1320 2320	— 22320RHR	SR215×18 SR215×10	2 1	MZ21	MZ26
	105	110	125	200	125	350	70	410	175	120	45	245	80	M20	M24	M16	SSN222	28	R 1/4	R 1/4	1222 2222	— 22222RHR	SR200×21 SR200×13.5 SR200×10	2 2 1	MZ23

[Notes] 1) Dimension x shows the shear between center of bearing and housing when one stabilizing ring is used. The value is 1/2 the width dimension of stabilizing ring.
 When mounting two stabilizing rings, x becomes equal to 0, since they are mounted to each side of bearing.
 2) If bearing of shaft diameter marked with * (shoulder diameter) receives large axial load, the use of spacers is recommended.

[Remarks] 1) Large bore diameter types (concentric collar locking) are identified by B suffixed to housing numbers.
 2) Housings shown below are equipped with eyebolts.
 SSN224~SSN232, SSN318~SSN332

Plummer blocks
split type, flat bottom
different bore type
SSN 2, 3
large bore type
SSN 2B, 3B
 d_1 (105) ~ 150 mm

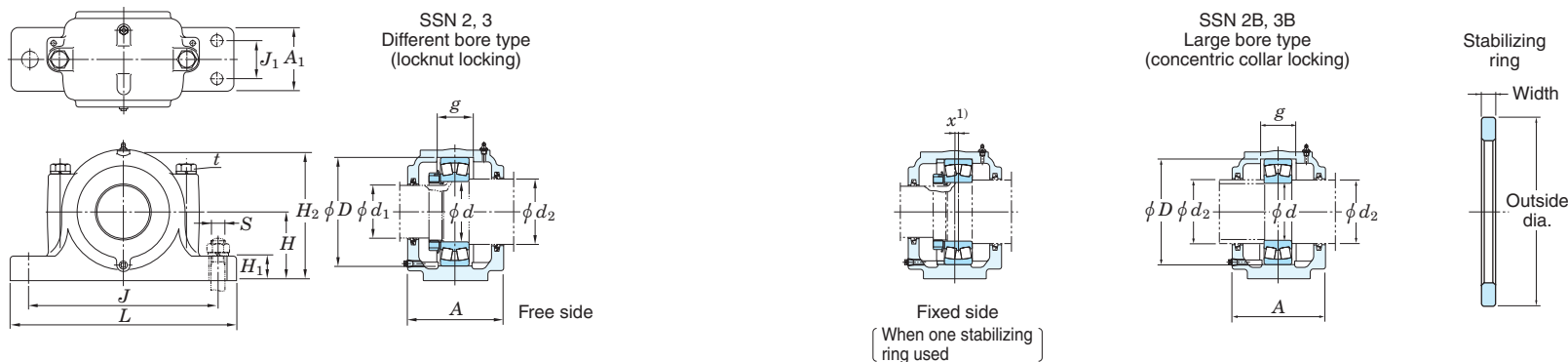

Shaft diameter (mm)			Dimensions (mm)										Bolt size		Housing No.	(Refer.) Housing mass (kg)	Grease nipple size	Drain plug size	Applicable bearing No.		Applicable stabilizing ring		Applicable oil seal No.		
d_1	d	$d_2^{2)}$	D	H	J	J_1	L	A	A_1	H_1	H_2	g	t Bolt size	S (Two) (Four)					Self-aligning ball brg.	Spherical roller brg.	Outside dia.×Width	Qty.	d_1 side	d_2 side	
105	110	125	240	150	390	70	450	190	130	50	300	90	M24	M24	M24	SSN322	51	R 1/4	R 1/4	1322 2322	— 22322RHR	SR240×20 SR240×10	2 1	MZ23	MZ28
	120	135	215	140	350	70	410	185	120	45	270	86	M20	M24	M16	SSN224	33	R 1/4	R 1/4	—	22224RHR 23224RH	SR215×14 SR215×10	2 1	MZ26	MZ30
115	120	135	260	160	450	90	530	200	160	60	320	96	M24	M30	M24	SSN324	63	R 1/4	R 1/4	—	22324RHR	SR260×10	1	MZ26	MZ30
	130	145	230	150	380	70	445	190	130	50	290	90	M24	M24	M20	SSN226	45	R 1/4	R 1/4	—	22226RHR 23226RH	SR230×13 SR230×10	2 1	MZ28	MZ33
125	130	150	280	170	470	90	550	210	160	60	340	103	M24	M30	M24	SSN326	96	R 1/4	R 1/4	—	22326RHR	SR280×10	1	MZ28	MZ34
	140	155	250	150	420	80	500	205	150	50	305	98	M24	M30	M24	SSN228	54	R 1/4	R 1/4	—	22228RHR 23228RH	SR250×15 SR250×10	2 1	MZ30	MZ35
135	140	160	300	180	520	100	610	235	170	65	365	112	M30	M30	M24	SSN328	117	R 1/4	R 1/4	—	22328R	SR300×10	1	MZ30	MZ36
	150	165	270	160	450	90	530	220	160	60	325	106	M24	M30	M24	SSN230	60	R 1/4	R 1/4	—	22230RHR 23230RH	SR270×16.5 SR270×10	2 1	MZ33	MZ37
145	150	170	320	190	560	110	650	245	180	65	385	118	M30	M30	M24	SSN330	132	R 1/4	R 1/4	—	22330R	SR320×10	1	MZ33	MZ38
	160	175	290	170	470	90	550	235	160	60	345	114	M24	M30	M24	SSN232	69	R 1/4	R 1/4	—	22232R 23232R	SR290×17 SR290×10	2 1	MZ34	MZ39
150	160	180	340	200	580	110	680	255	190	70	405	124	M30	M36	M30	SSN332	145	R 1/4	R 1/4	—	22332R	SR340×10	1	MZ34	MZ40

[Notes] 1) Dimension x shows the shear between center of bearing and housing when one stabilizing ring is used. The value is 1/2 the width dimension of stabilizing ring.
 When mounting two stabilizing rings, x becomes equal to 0, since they are mounted to each side of bearing.
 2) If bearing of shaft diameter marked with * (shoulder diameter) receives large axial load, the use of spacers is recommended.

[Remarks] 1) Large bore diameter types (concentric collar locking) are identified by B suffixed to housing numbers.
 2) Housings shown below are equipped with eyebolts.
 SSN224~SSN232, SSN318~SSN332

Plummer blocks
split type, large size

SD 5, 6
SD 33, 34

d_1 150 ~ 240 mm

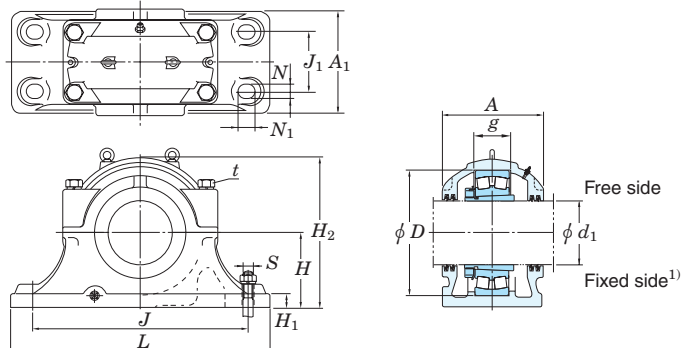

Shaft dia. (mm) d_1	Dimensions (mm)												Bolt size S	Housing No.	(Refer.) Housing mass (kg)	Grease nipple size	Drain plug size	Applicable bearing No.	Applicable adapter ass'y No.	Applicable oil seal No. MZ	
	D	H	J	J_1	L	A	A_1	H_1	H_2	N	N_1	g									t Bolt size
150	260	160	450	110	540	230	200	50	315	36	46	77	M24	M30	SD3334	70	R $\frac{3}{8}$	R $\frac{3}{8}$	23034RHK	H3034	MZ34
	310	180	510	140	620	270	250	60	360	36	46	96	M24	M30	SD534	105	R $\frac{3}{8}$	R $\frac{3}{8}$	22234RK	H3134	MZ34
	360	210	610	170	740	300	290	65	420	36	46	130	M30	M30	SD634	165	R $\frac{3}{8}$	R $\frac{3}{8}$	22334RK	H2334	MZ34
160	280	170	470	120	560	250	220	50	335	36	46	84	M24	M30	SD3336	80	R $\frac{3}{8}$	R $\frac{3}{8}$	23036RHK	H3036	MZ36
	320	190	540	150	650	280	260	60	380	36	46	96	M24	M30	SD536	120	R $\frac{3}{8}$	R $\frac{3}{8}$	22236RK	H3136	MZ36
	380	225	640	180	780	320	310	70	450	43	59	136	M30	M36	SD636	200	R $\frac{3}{8}$	R $\frac{3}{8}$	22336RK	H2336	MZ36
170	290	170	470	120	560	250	220	50	340	36	46	85	M24	M30	SD3338	90	R $\frac{3}{8}$	R $\frac{3}{8}$	23038RK	H3038	MZ38
	340	200	570	160	700	290	280	65	400	36	46	102	M30	M30	SD538	145	R $\frac{3}{8}$	R $\frac{3}{8}$	22238RK	H3138	MZ38
	400	240	680	190	820	330	320	70	475	43	59	142	M30	M36	SD638	220	R $\frac{3}{8}$	R $\frac{3}{8}$	22338RK	H2338	MZ38
180	310	180	510	140	620	270	250	60	360	36	46	92	M24	M30	SD3340	100	R $\frac{3}{8}$	R $\frac{3}{8}$	23040RK	H3040	MZ40
	340	200	570	160	700	310	280	65	400	36	46	122	M30	M30	SD3440	135	R $\frac{3}{8}$	R $\frac{3}{8}$	23140RK	H3140	MZ40
	360	210	610	170	740	300	290	65	420	36	46	108	M30	M30	SD540	170	R $\frac{3}{8}$	R $\frac{3}{8}$	22240RK	H3140	MZ40
	420	250	710	200	860	350	340	85	500	43	59	148	M36	M36	SD640	250	R $\frac{3}{8}$	R $\frac{1}{2}$	22340RK	H2340	MZ40
200	340	200	570	160	700	290	280	65	400	36	46	100	M30	M30	SD3344	130	R $\frac{3}{8}$	R $\frac{3}{8}$	23044RK	H3044	MZ44
	370	225	640	180	780	320	310	70	445	43	59	130	M30	M36	SD3444	185	R $\frac{3}{8}$	R $\frac{3}{8}$	23144RK	H3144	MZ44
	400	240	680	190	820	330	320	70	475	43	59	118	M30	M36	SD544	220	R $\frac{3}{8}$	R $\frac{3}{8}$	22244RK	H3144	MZ44
	460	280	770	210	920	360	350	85	550	43	59	155	M36	M36	SD644	320	R $\frac{3}{8}$	R $\frac{1}{2}$	22344RK	H2344	MZ44
220	360	210	610	170	740	300	290	65	420	36	46	102	M30	M30	SD3348	160	R $\frac{3}{8}$	R $\frac{3}{8}$	23048RK	H3048	MZ48
	400	240	680	190	820	330	320	70	475	43	59	138	M30	M36	SD3448	210	R $\frac{3}{8}$	R $\frac{3}{8}$	23148RK	H3148	MZ48
	440	260	740	200	880	340	330	85	515	43	59	130	M36	M36	SD548	260	R $\frac{3}{8}$	R $\frac{1}{2}$	22248RK	H3148	MZ48
	500	300	830	230	990	390	380	100	590	50	67	165	M36	M42	SD648	415	R $\frac{3}{8}$	R $\frac{1}{2}$	22348RK	H2348	MZ48
240	400	240	680	190	820	340	320	70	475	43	59	114	M30	M36	SD3352	215	R $\frac{3}{8}$	R $\frac{3}{8}$	23052RK	H3052	MZ52
	440	260	740	200	880	360	350	85	515	43	59	154	M36	M36	SD3452	245	R $\frac{3}{8}$	R $\frac{1}{2}$	23152RK	H3152	MZ52
	480	280	790	210	940	370	360	85	560	43	59	140	M36	M36	SD552	325	R $\frac{3}{8}$	R $\frac{1}{2}$	22252RK	H3152	MZ52
	540	325	890	250	1060	410	400	100	640	50	67	175	M36	M42	SD652	490	R $\frac{3}{8}$	R $\frac{3}{4}$	22352RK	H2352	MZ52

[Note] 1) Since bearings are designed to be locked by housing, stabilizing rings are unnecessary.

[Remark] The structure of certain housings may differ from those shown in the figures.

Plummer blocks
split type, large size

SD 5, 6
SD 33, 34

d_1 260 ~ 360 mm

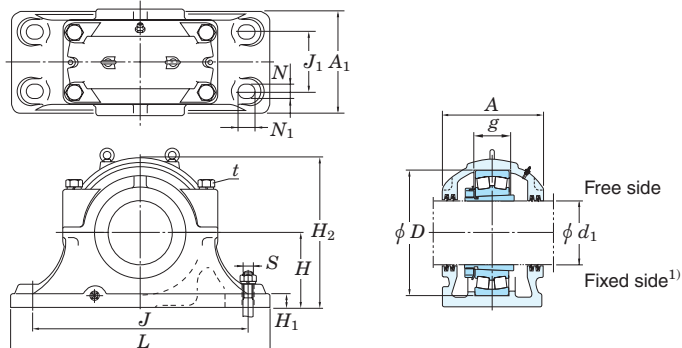

Shaft dia. (mm) d_1	Dimensions (mm)													Bolt size S	Housing No.	(Refer.) Housing mass (kg)	Grease nipple size	Drain plug size	Applicable bearing No.	Applicable adapter ass'y No.	Applicable oil seal No. MZ
	D	H	J	J ₁	L	A	A ₁	H ₁	H ₂	N	N ₁	g	t Bolt size								
260	420	250	710	200	860	350	340	85	500	43	59	116	M36	M36	SD3356	245	R 3/8	R 1/2	23056RK	H3056	MZ56
	460	280	770	210	920	360	350	85	550	43	59	156	M36	M36	SD3456	320	R 3/8	R 1/2	23156RK	H3156	MZ56
	500	300	830	230	990	390	380	100	590	50	67	140	M36	M42	SD556	395	R 3/8	R 1/2	22256RK	H3156	MZ56
	580	355	930	270	1 110	440	430	110	690	57	77	185	M42	M48	SD656	615	R 3/8	R 3/4	22356RK	H2356	MZ56
280	460	280	770	210	920	360	350	85	550	43	59	128	M36	M36	SD3360	305	R 3/8	R 1/2	23060RK	H3060	MZ60
	500	300	830	230	990	390	380	100	590	50	67	170	M36	M42	SD3460	400	R 3/8	R 1/2	23160RK	H3160	MZ60
	540	325	890	250	1 060	410	400	100	640	50	67	150	M36	M42	SD560	490	R 3/8	R 3/4	22260RK	H3160	MZ60
300	480	280	790	210	940	380	360	85	560	43	59	131	M36	M36	SD3364	325	R 3/8	R 1/2	23064RK	H3064	MZ64
	540	325	890	250	1 060	430	400	100	640	50	67	186	M36	M42	SD3464	480	R 3/8	R 3/4	23164RK	H3164	MZ64
	580	355	930	270	1 110	440	430	110	690	57	77	160	M42	M48	SD564	600	R 3/8	R 3/4	22264RK	H3164	MZ64
320	520	310	860	230	1 020	400	370	100	615	50	67	143	M36	M42	SD3368	420	R 3/8	R 3/4	23068RK	H3068	MZ68
	580	355	930	270	1 110	470	450	110	690	57	77	200	M42	M48	SD3468	645	R 3/8	R 3/4	23168RK	H3168	MZ68
340	540	325	890	250	1 060	410	390	100	640	50	67	144	M36	M42	SD3372	470	R 3/8	R 3/4	23072RK	H3072	MZ72
360	560	340	900	260	1 080	410	390	100	665	50	67	145	M36	M42	SD3376	485	R 3/8	R 3/4	23076RK	H3076	MZ76

[Note] 1) Since bearings are designed to be locked by housing, stabilizing rings are unnecessary.

[Remark] The structure of certain housings may differ from those shown in the figures.

Plummer blocks
split type, large size

SD 31

d_1 150 ~ 300 mm

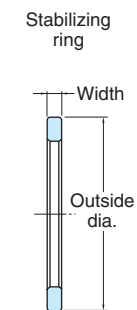
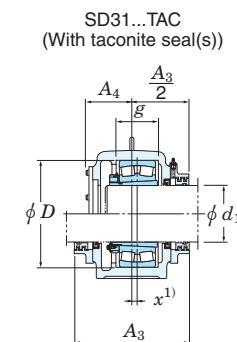
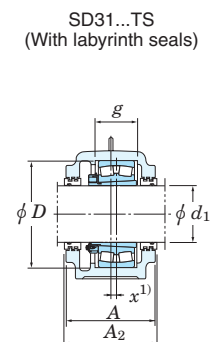
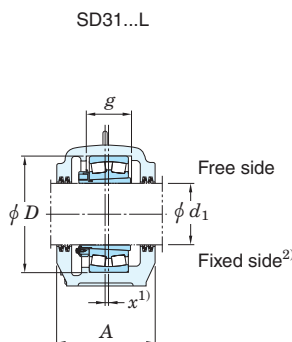
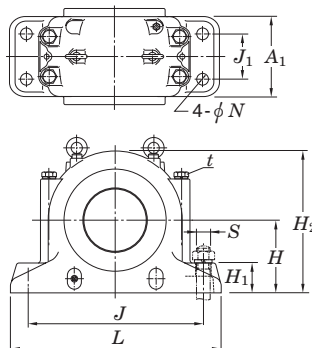

Shaft dia. (mm)	Dimensions (mm)																Housing No.	Bolt size S	(Refer.) Housing mass (kg)	Grease nipple size	Drain plug size	Applicable bearing No.	Applicable adapter ass'y No.	Applicable stabilizing ring ²⁾	
	d_1	D	H	J	J_1	L	A	A_1	A_2	A_3	A_4	H_1	H_2	N	g	t Bolt size								x^1	Outside dia.
150	280	170	430	100	510	230	180	240	300	120	70	335	28	108	M20	14	SD3134L	M24	65	R 3/8	R 3/8	23134RHK	H3134	SR280×10	2
160	300	180	450	110	530	240	190	250	310	125	75	355	28	116	M20	15	SD3136L	M24	75	R 3/8	R 3/8	23136RK	H3136	SR300×10	2
170	320	190	480	120	560	260	210	270	330	135	80	375	28	124	M24	10	SD3138L	M24	95	R 3/8	R 3/8	23138RK	H3138	SR320×10	2
180	340	210	510	130	610	280	230	290	350	145	85	410	35	132	M24	10	SD3140L	M30	120	R 3/8	R 3/8	23140RK	H3140	SR340×10	2
200	370	220	540	140	640	290	240	300	360	152	90	435	35	140	M24	12	SD3144L	M30	140	R 3/8	R 3/8	23144RK	H3144	SR370×10	2
220	400	240	600	150	700	310	260	320	380	162	95	475	35	148	M30	12	SD3148L	M30	180	R 3/8	R 3/8	23148RK	H3148	SR400×10	2
240	440	260	650	160	770	320	280	330	396	170	100	515	42	164	M30	13	SD3152L	M36	220	R 3/8	R 1/2	23152RK	H3152	SR440×10	2
260	460	280	670	160	790	320	280	330	396	170	105	550	42	166	M30	16	SD3156L	M36	250	R 3/8	R 1/2	23156RK	H3156	SR460×10	2
280	500	300	710	190	830	350	310	360	420	193	110	590	42	180	M30	22	SD3160L	M36	300	R 3/8	R 1/2	23160RK	H3160	SR500×10	2
300	540	320	750	200	880	370	330	380	440	203	115	630	42	196	M30	23	SD3164L	M36	340	R 3/8	R 3/4	23164RK	H3164	SR540×10	2

[Notes] 1) Dimension x shows the shear between center of bearing and housing.
2) Stabilizing rings are mounted to the fixed side of the SD 31...TS and SD 31 ...TAC series (both sides of bearings).
SD31...L series are locked by housings.

[Remark] Use of labyrinth or taconite seals are indicated by TS or TAC suffixed to housing numbers.

Plummer blocks
one-piece type

V 5, 6

d_1 30 ~ 65 mm

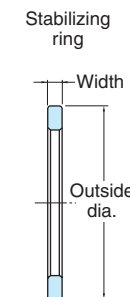
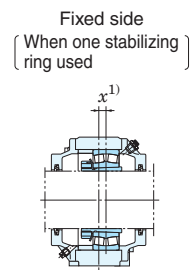
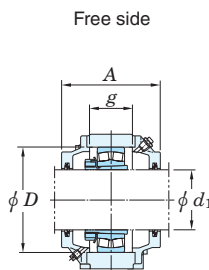
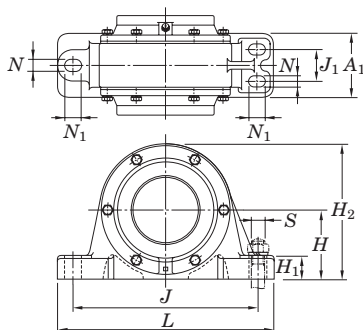

Shaft dia. (mm) d_1	Dimensions (mm)												Bolt size S		Housing No.	(Refer.) Housing mass (kg)	Grease nipple size	Drain plug size	Housing No.	Applicable bearing No.		Applicable adapter ass'y No.	Applicable stabilizing ring		Applicable oil seal No. MZ
	D	H	J	J_1	L	A	A_1	H_1	H_2	N	N_1	g	(Two)	(Four)						Self-aligning ball brg.	Spherical roller brg.		Outside dia.×Width	Qty.	
30	80	60	170	—	205	95	60	25	118	16	20	37	M14	—	V607	4.8	R 1/8	R 1/8	V080	1307K 2307K	—	H307X H2307X	SR80×8 SR80×6	2 1	MZ07
	80	60	170	—	205	95	60	25	118	16	20	37	M14	—	V508	4.4	R 1/8	R 1/8	V080	1208K 2208K	— 22208RHRK	H208X H308X	SR80×9.5 SR80×7	2 2	MZ08
35	90	67	170	—	205	100	60	25	128	16	20	39	M14	—	V608	5.1	R 1/8	R 1/8	V090	1308K 2308K	21308RHK 22308RHRK	H308X H2308X	SR90×8 SR90×6	2 1	MZ08
	85	63	170	—	205	98	60	25	125	16	20	39	M14	—	V509	4.6	R 1/8	R 1/8	V085	1209K 2209K	— 22209RHRK	H209X H309X	SR85×10 SR85×8	2 2	MZ09
40	100	71	210	—	255	106	70	28	140	16	23	42	M14	—	V609	6.6	R 1/8	R 1/8	V100	1309K 2309K	21309RHK 22309RHRK	H309X H2309X	SR100×8.5 SR100×6	2 1	MZ09
	90	67	170	—	205	100	60	25	128	16	20	39	M14	—	V510	4.7	R 1/8	R 1/8	V090	1210K 2210K	— 22210RHRK	H210X H310X	SR90×9.5 SR90×8	2 2	MZ10
45	110	80	210	—	255	112	70	30	155	21	25	46	M18	—	V610	8.3	R 1/8	R 1/8	V110	1310K 2310K	21310RHK 22310RHRK	H310X H2310X	SR110×9.5 SR110×6	2 1	MZ10
	100	71	210	—	255	106	70	28	140	16	23	42	M14	—	V511	6.2	R 1/8	R 1/8	V100	1211K 2211K	— 22211RHRK	H211X H311X	SR100×10.5 SR100×8.5	2 2	MZ11
50	120	85	230	—	275	118	80	30	165	21	25	49	M18	—	V611	10	R 1/8	R 1/8	V120	1311K 2311K	21311RHK 22311RHRK	H311X H2311X	SR120×10 SR120×6	2 1	MZ11
	110	80	210	—	255	112	70	30	155	21	25	46	M18	—	V512	7.6	R 1/8	R 1/8	V110	1212K 2212K	— 22212RHRK	H212X H312X	SR110×12 SR110×9	2 2	MZ12
55	130	90	230	—	280	118	80	30	175	21	25	50	M18	—	V612	11	R 1/8	R 1/8	V130	1312K 2312K	21312RHK 22312RHRK	H312X H2312X	SR130×9.5 SR130×4	2 1	MZ12
	120	85	230	—	275	118	80	30	165	21	25	49	M18	—	V513	9.9	R 1/8	R 1/8	V120	1213K 2213K	— 22213RHRK	H213X H313X	SR120×13 SR120×9	2 2	MZ13
60	125	90	230	—	280	118	80	30	175	21	25	50	M18	—	V514	10	R 1/8	R 1/8	V125	—	22214RHRK	H314X	SR125×9.5	2	MZ13
	140	100	260	—	315	136	90	32	195	25	30	56	M22	—	V613	17	R 1/8	R 1/8	V140	1313K 2313K	21313RHK 22313RHRK	H313X H2313X	SR140×11.5 SR140×8	2 1	MZ13
65	150	100	260	—	315	140	90	32	195	25	30	56	M22	—	V614	16	R 1/8	R 1/8	V150	—	21314RHK 22314RHRK	H314X H2314X	SR150×10.5 SR150×5	2 1	MZ13
	130	90	230	—	280	118	80	30	175	21	25	50	M18	—	V515	10	R 1/8	R 1/8	V130	1215K 2215K	— 22215RHRK	H215X H315X	SR130×12.5 SR130×9.5	2 2	MZ15
	160	112	290	—	345	150	100	35	224	25	30	62	M22	—	V615	23	R 1/8	R 1/8	V160	1315K 2315K	21315RHK 22315RHRK	H315X H2315X	SR160×12.5 SR160×7	2 1	MZ15

[Note] 1) Dimension x shows the shear between center of bearing and housing when one stabilizing ring is used. The value is 1/2 the width dimension of stabilizing ring. When mounting two stabilizing rings, x becomes equal to 0, since they are mounted to each side of bearing.

[Remark] Housings shown below are equipped with eyebolts. V180~V340 (V520~V538 and V617~V632)

Plummer blocks
one-piece type

V 5, 6

d_1 70 ~ (125) mm

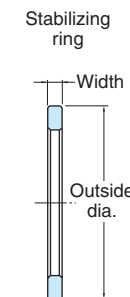
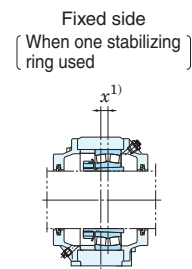
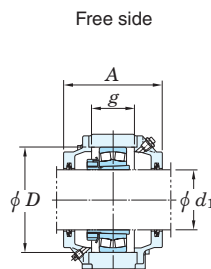
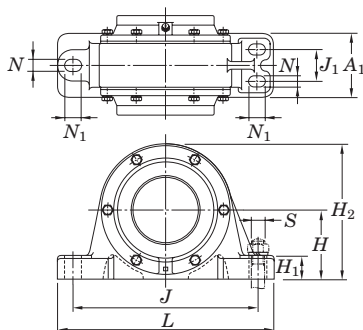

Shaft dia. (mm) d_1	Dimensions (mm)												Bolt size S		Housing No.	(Refer.) Housing mass (kg)	Grease nipple size	Drain plug size	Housing No.	Applicable bearing No.		Applicable adapter ass'y No.	Applicable stabilizing ring		Applicable oil seal No. MZ
	D	H	J	J_1	L	A	A_1	H_1	H_2	N	N_1	g	(Two)	(Four)						Self-aligning ball brg.	Spherical roller brg.		Outside dia. \times Width	Qty.	
70	140	100	260	—	315	136	90	32	195	25	30	56	M22	—	V516	16	R 1/8	R 1/8	V140	1216K 2216K	— 22216RHRK	H216X H316X	SR140×15 SR140×11.5	2 2	MZ16
	170	112	290	—	345	165	100	35	224	25	30	62	M22	—	V616	22	R 1/8	R 1/8	V170	1316K 2316K	21316RHK 22316RHRK	H316X H2316X	SR170×11.5 SR170×4	2 1	MZ16
75	150	100	260	—	315	140	90	32	195	25	30	56	M22	—	V517	15	R 1/8	R 1/8	V150	1217K 2217K	— 22217RHRK	H217X H317X	SR150×14 SR150×10	2 2	MZ17
	180	125	320	56	380	170	110	40	243	23	32	70	—	M20	V617	28	R 1/4	R 1/4	V180	1317K 2317K	21317RHK 22317RHRK	H317X H2317X	SR180×14.5 SR180×10	2 1	MZ17
80	160	112	290	—	345	150	100	35	224	25	30	62	M22	—	V518	22	R 1/8	R 1/8	V160	1218K 2218K	— 22218RHRK	H218X H318X	SR160×16 SR160×11	2 2	MZ18
	190	125	320	56	380	170	110	40	243	23	32	70	—	M20	V618	27	R 1/4	R 1/4	V190	1318K 2318K	21318RHK 22318RHRK	H318X H2318X	SR160×9.6 SR190×13.5 SR190×6	1 2 2	MZ18
85	170	112	290	—	345	165	100	35	224	25	30	62	M22	—	V519	21	R 1/8	R 1/8	V170	1219K 2219K	— 22219RHRK	H219X H319X	SR170×11 SR170×9.5	2 2	MZ19
	200	132	350	60	410	190	120	45	265	23	32	82	—	M20	V619	37	R 1/4	R 1/4	V200	1319K 2319K	21319RHK 22319RHRK	H319X H2319X	SR200×18.5 SR200×15	2 2	MZ19
90	180	125	320	56	380	170	110	40	243	23	32	70	—	M20	V520	27	R 1/4	R 1/4	V180	1220K 2220K	— 22220RHRK	H220X H320X	SR180×18 SR180×12	2 2	MZ20
	215	140	350	60	410	190	120	45	280	23	32	82	—	M20	V620	40	R 1/4	R 1/4	V215	1320K 2320K	21320RHK 22320RHRK	H320X H2320X	SR180×9.7 SR215×17.5 SR215×9	1 2 1	MZ20
100	200	132	350	60	410	190	120	45	265	23	32	82	—	M20	V522	36	R 1/4	R 1/4	V200	1222K 2222K	— 22222RHRK	H222X H322X	SR200×22 SR200×14.5	2 2	MZ22
	240	160	390	80	470	218	150	50	315	23	32	96	—	M20	V622	56	R 1/4	R 1/4	V240	1322K 2322K	21322RHK 22322RHRK	H322X H2322X	SR200×12.2 SR240×23 SR240×16	1 2 1	MZ22
110	215	140	350	60	410	190	120	45	280	23	32	82	—	M20	V524	39	R 1/4	R 1/4	V215	—	22224RHRK 23224RHK	H3124 H2324	SR215×12 SR215×6	2 1	MZ24
	260	170	450	92	540	236	160	60	335	29	42	103	—	M24	V624	71	R 1/4	R 1/4	V260	—	22324RHRK	H2324	SR260×17	1	MZ24
115	230	150	380	65	450	200	130	50	300	23	32	86	—	M20	V526	48	R 1/4	R 1/4	V230	—	22226RHRK 23226RHK	H3126 H2326	SR230×11 SR230×6	2 1	MZ26
	280	180	470	92	560	243	160	60	355	29	42	103	—	M24	V626	82	R 1/4	R 1/4	V280	—	22326RHRK	H2326	SR280×15	1	MZ26
125	250	160	420	80	500	218	150	50	315	23	32	94	—	M20	V528	54	R 1/4	R 1/4	V250	—	22228RHRK 23228RHK	H3128 H2328	SR250×13 SR250×6	2 1	MZ28

[Note] 1) Dimension x shows the shear between center of bearing and housing when one stabilizing ring is used. The value is 1/2 the width dimension of stabilizing ring.
When mounting two stabilizing rings, x becomes equal to 0, since they are mounted to each side of bearing.

[Remark] Housings shown below are equipped with eyebolts.
V180~V340 (V520~V538 and V617~V632)

Plummer blocks
one-piece type

V 5, 6

d_1 (125) ~ 170 mm

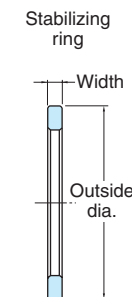
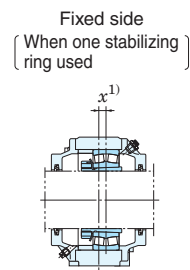
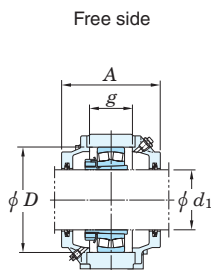
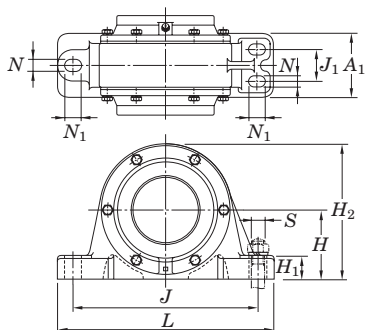

Shaft dia. (mm) d_1	Dimensions (mm)												Bolt size S		Housing No.	(Refer.) Housing mass (kg)	Grease nipple size	Drain plug size	Housing No.	Applicable bearing No.		Applicable adapter ass'y No.	Applicable stabilizing ring		Applicable oil seal No. MZ
	D	H	J	J_1	L	A	A_1	H_1	H_2	N	N_1	g	(Two)	(Four)						Self-aligning ball brg.	Spherical roller brg.		Outside dia. \times Width	Qty.	
125	300	190	520	92	610	250	170	65	375	29	50	113	—	M24	V628	101	R 1/4	R 1/4	V300	—	22328RK	H2328	SR300 \times 11	1	MZ28
135	270	170	450	92	540	236	160	60	335	29	42	103	—	M24	V530	64	R 1/4	R 1/4	V270	—	22230RHRK 23230RHK	H3130 H2330	SR270 \times 15 SR270 \times 7	2 1	MZ30
	320	200	560	92	660	258	180	65	405	29	50	122	—	M24	V630	129	R 1/4	R 1/4	V320	—	22330RK	H2330	SR320 \times 14	1	MZ30
140	290	190	470	92	560	250	170	60	375	29	50	113	—	M24	V532	92	R 1/4	R 1/4	V290	—	22232RK 23232RK	H3132 H2332	SR290 \times 16.5 SR290 \times 9	2 1	MZ32
	340	212	580	104	680	300	190	65	425	33	54	130	—	M27	V632	149	R 1/4	R 1/4	V340	—	22332RK	H2332	SR340 \times 16	1	MZ32
150	310	200	560	92	660	258	180	65	405	29	50	122	—	M24	V534	110	R 1/4	R 1/4	V310	—	22234RK 23234RK	H3134 H2334	SR310 \times 18 SR310 \times 12	2 1	MZ34
160	320	200	560	92	660	258	180	65	405	29	50	122	—	M24	V536	110	R 1/4	R 1/4	V320	—	22236RK 23236RK	H3136 H2336	SR320 \times 18 SR320 \times 10	2 1	MZ36
170	340	212	580	104	680	300	190	65	425	33	54	130	—	M27	V538	130	R 1/4	R 1/4	V340	—	22238RK 23238RK	H3138 H2338	SR340 \times 19 SR340 \times 10	2 1	MZ38

[Note] 1) Dimension x shows the shear between center of bearing and housing when one stabilizing ring is used. The value is 1/2 the width dimension of stabilizing ring. When mounting two stabilizing rings, x becomes equal to 0, since they are mounted to each side of bearing.

[Remark] Housings shown below are equipped with eyebolts. V180~V340 (V520~V538 and V617~V632)