

威科制造商
REFCO Manufacturing Ltd.
Industriestrasse 11
CH-6285 Hitzkirch (Switzerland)

电话 + 41 41 919 72 82
传真 + 41 41 919 72 83
电邮 info@refco.ch
网址 www.refco.ch

HVAC/R
Service Products



威科

HVAC/R
Service Products



ED24



Vacuum Pumps

真空泵

1



Charging Stations
Charging Scales
Charging Cylinders

充气台
充气计量仪
充气罐

2



Pressure Gauges
Vacuum Gauges

压力表
真空表

3



Manifolds
Hoses
Valves
Connectors

复式接头
软管
阀
接口

4



UV Leak Detectors
Electronic Leak Detectors
Propane Leak Detectors
Leak Search Sprays

紫外线泄漏探测器
电子泄漏探测器
丙烷泄漏探测器
泄漏搜寻喷射器

5



Thermometers
Control Instruments
Thermostats, Timers

温度计
控制仪器
恒温计时器

6



Pinch-off-Tools
Tube Cutters
Flaring Tools
Tube Benders
Hand Tools

夹取工具
管切割器
燃烧工具
弯管器
手工工具

7

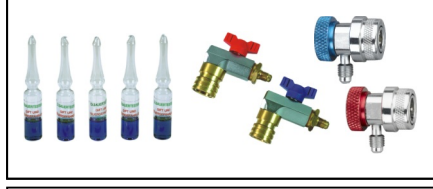

Auto Valves
Tools and Accessories
Universal Relay

自动阀
工具与附件
普及型继电器

8

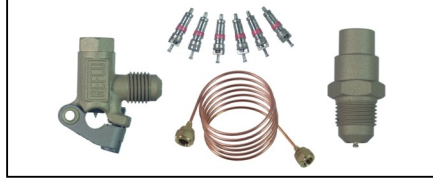

Capillary Tubes
Access Valves

毛细管
插入阀

9

Technical- & Company Information

技术数据与公司信息

10



威科制造商
REFCO Manufacturing Ltd.
Industriestrasse 11
CH-6285 Hitzkirch (Switzerland)

Phone
Fax
info@refco.ch

+41 41 919 72 82
+41 41 919 72 83
www.refco.ch



Vacuum Pumps

真空泵

威科制造商
REFCO Manufacturing Ltd.
Industriestrasse 11
CH-6285 Hitzkirch (Switzerland)

Phone
Fax
info@refco.ch

+41 41 91972 82
+41 41 91972 83
www.refco.ch



RL-Family

All vacuum pumps are now available in the unique ergonomic REFECO design. Standard features are:

- Two-stage rotary vane pump
- Latest design and technology allows extremely compact design
- Internal oil pump with unique feature
- High end materials result in low weight top quality
- Sturdy ergonomic handle stays cool to the touch
- Large and easily accessible oil fill port to prevent spillage when filling
- Sight glass for easy viewing of the oil level
- Built in on/off switch to prevent breakage or accidental shut off
- Gas ballast valve
- Easily replaceable one piece cartridge allows exchange without special tooling
- Special designed oil exhaust filter to reduce oil mist
- Modern metal, rugged pump design with high quality plastic housing to absorb shocks
- Extremely low point of gravity which makes tipping over in a service van nearly impossible
- Swiss quality production manufactured under ISO 9001

由威科专利设计真空泵，均独一无二，根据人体工程学所生产标准特征如下：

- 两级阶段旋转式真空泵
- 最新型，极轻巧设计
- 针对冷冻及空调用途
- 独一无二内置式油泵设计
- 体积小，速度快
- 坚固手幻，能有效阻隔运行时所产生之热能
- 特大加油孔
- 润滑油视镜水平显示
- 配置开关，可作紧急用途
- 连接处有球阀设计，方便操作
- 特别设置油泵过滤网，减少雾化现象
- 时尚金属，坚固外型，以高品质塑料外壳包装，防止短路主产生危险
- 瑞士高品质产品，生产于ISO 9001 标准



RL-2

RL-2

The most compact and lightest in the REFECO range

Technical Data:

Dimensions:	271 x 166 x 195 mm
Weight:	3.8 kg
Free air displacement:	35 l/min (1.25 cfm)
Factory micron rating:	15 micron
Motor:	0.16 KW (1/5 HP) / 2400 rpm
Power supply:	220/240 V, 50/60 Hz
Connection:	1/4" SAE
Oil capacity:	125 ml

Part No 4661083

RL-2

最轻巧坚固型

技术数据:

体积:	271 x 166 x 195毫米
重量:	3.8公斤
吸气量:	35公升每分钟/1.25立方尺每分钟
等级:	15微米
马力:	0.16千瓦 (1/5匹) 2400 rpm
电压:	220/240 V, 50/60 Hz
连接口:	1/4" SAE
油容量:	125毫升
部件号	4661083



RL-4

RL-4
The hard working light weight

Technical Data:
 Dimensions: 301 x 152 x 204 mm
 Weight: 5.65 kg
 Free air displacement: 65 l/min (2.3 cfm)
 Factory micron rating: 15 micron
 Motor: 0.19 KW (1/4 HP) / 2400 rpm
 Power supply: 220/240 V, 50/60 Hz
 Connections: 1/4" SAE + 3/8" SAE
 Oil capacity: 250 ml

Part No 4661741

RL-4
中级轻巧坚固型

技术数据:
 体积: 301 x 152 x 204毫米
 重量: 5.65公斤
 吸气量: 65公升/每分钟(2.3立方尺每分钟)
 等级: 15微米
 马力: 0.19千瓦(1/4匹) /2400 rpm
 电压: 220/240 V, 50/60 Hz
 连接口: 1/4" SAE + 3/8" SAE
 油容量: 250毫升

部件号 4661741

CHF

1185.00



RL-8

RL-8
The one with maximum capacity and integrated ball valve

Technical Data:
 Dimensions: 360 x 220 x 250 mm
 Weight: 11.8 kg
 Free air displacement: 150 l/min (5.3 cfm)
 Factory micron rating: 15 micron
 Motor: 0.37 KW (1/2 HP) / 2800 rpm
 Power supply: 220/240 V, 50/60 Hz
 Connections: 1/4" SAE + 3/8" SAE with integrated ball valve
 Oil capacity: 500 ml

Part No 4507348

RL-8
重量级坚固型配备组合式球阀

技术数据:
 体积: 360 x 220 x 250毫米
 重量: 11.8公斤
 吸气量: 150公升/每分钟(5.3立方尺每分钟)
 等级: 15微米
 马力: 0.37千瓦(1/2匹) /2800 rpm
 电压: 220/240 V, 50/60 Hz
 连接口: 1/4" SAE + 3/8" SAE 组合式球阀
 油容量: 500毫升

部件号 4507348

1532.00

High Vacuum Pump

高品质真空泵

1



RL-2-307-RS



RL-4-307-RS



RL-8-307-RS



DV-44/45

RL-2-307-RS
Intake port 1/4" SAE with backflow prevention for RL-2 vacuum pump.
Part No 4663786

RL-4-307-RS
Intake port 1/4" SAE / 3/8" SAE with backflow prevention for RL-4 vacuum pump.
Part No 4663336

RL-8-307-RS
Intake port 1/4" SAE / 3/8" SAE with ball valve and backflow prevention for RL-8 vacuum pump.
Part No 4664244

Oil for vacuum- pumps RL-2/RL-4/RL-8

DV-44
Vacuum pump oil 1/4 litre bottle
Part No 4495340

DV-45
Vacuum pump oil 1/2 litre bottle
Part No 4495358

DV-46
Vacuum pump oil 1 litre bottle
Part No 4495366

DV-46-Y
Vacuum pump oil 1 litre bottle with sealed top
Part No 4495323

DV-48
Vacuum pump oil 5 litre can
Part No 4495331

ESTEROIL for RL-2/RL-4/RL-8

P-17-S-0.25
1/4 ltr. Esteroil bottle
Part No 4503376

P-17-S-1
1 ltr. Esteroil bottle
Part No 4503384

RL-2-307-RS
RL-2专用, 1/4" SAE, 吸入处防止回流接头
部件号 **4663786**

RL-4-307-RS
RL-4专用, 1/4" SAE / 3/8" SAE, 吸入处防止回流接头
部件号 **4663336**

RL-8-307-RS
RL-8专用, 1/4" SAE / 3/8" SAE, 吸入处防止回流球阀
部件号 **4664244**

真空泵用油RL-2/RL-4/RL-8

DV-44
真空泵润滑油1/4公升/瓶
部件号 **4495340**

DV-45
真空泵润滑油1/2公升/瓶
部件号 **4495358**

DV-46
真空泵润滑油1公升/瓶
部件号 **4495366**

DV-46-Y
真空泵润滑油1公升/瓶
部件号 **4495323**

DV-48
真空泵润滑油5公升/瓶
部件号 **4495331**

依斯特油用RL-2/RL-4/RL-8

P-17-S-0.25
1/4公升依斯特油
部件号 **4503376**

P-17-S-1
1公升依斯特油
部件号 **4503384**

CHF

24.20

31.00

56.00

15.00

28.30

40.50

49.00

106.00

30.50

89.00



RD-320

RD-320

Latest high performance vacuum pump for large commercial, air conditioning and specialised operations. This model offers you the the following ultimate features:

- Finned oil box for greater cooling capability
- Sustainable ultimate vacuum due to cooler running
- Versatile connections - multiple choice suction fitting
- Fully O-ring sealed cartridge
- Magnetic sump plus aids in capturing ferrous contaminants
- Fan cooled heavy duty 1 hp motor

Technical Data:

Dimension: 540 x 160 x 250 mm
 Weight: 24.5 kg
 Free air displacement: 300 l/min (10.5 cfm)
 Factory micron rating: 1 micron
 Motor: 0.75 KW (1 HP) / 1400 rpm
 Power supply: 220/240 V, 50/60 Hz
 Connection: 3/8" SAE, 1/2" ACME, 1/4" SAE

Part No 4679373

RD-320

最新的高效能真空泵用于大型专业冷冻、空调和专业操作系统。

这个模型为您提供以下特点：

- 鳍型油盒使其具有更加强大冷却功能
- 冷气机运转时具有超强持续真空状态
- 通用连接器为吸入安装提供更多选择
- 环型全封闭机芯
- 磁性排污格更能吸附金属污染物
- 以1千瓦（1匹）马力的强劲功率快速冷却机器

技术数据：

体积： 540 x 160 x 250毫米
 重量： 24.5公斤
 吸气量： 300公升/每分钟(10.5立方尺每分钟)
 等级： 1微米
 马力： 0.75千瓦(1匹) /1400 rpm
 电压： 220/240 V, 50/60 Hz
 连接口： 3/8" SAE, 1/2" ACME, 1/4" SAE

部件号 4679373

CHF

1

7050.00



威科制造商
REFCO Manufacturing Ltd.
Industriestrasse 11
CH-6285 Hitzkirch (Switzerland)

Phone
Fax
info@refco.ch

+41 41 919 72 82
+41 41 919 72 83
www.refco.ch



Charging Stations
Charging Scales
Charging Cylinders

充气台
充气计量仪
充气罐

威科制造商
REFCO Manufacturing Ltd.
Industriestrasse 11
CH-6285 Hitzkirch (Switzerland)

Phone
Fax
info@refco.ch

+41 41 919 72 82
+41 41 919 72 83
www.refco.ch

Recovery station

修复站



PLUS-8

PLUS-8

Recovery station, suitable for all refrigerants including R410A
Oil-less compressor 1/2 HP, maintenance free
Sturdy construction
Pressure gauges class 1.6
Automatic recovery of liquid and vapor refrigerants
Userfriendly
Self purging feature
Built-in filter, easy to clean and replace

Portable, light weight: 28 lbs (12 kg)
Dimensions: 38 x 20 x 35 cm
Recovery rate:
720 lb (327 kg) / hour push-pull
180 lb (82 kg) / hour liquid phase
75 lb (35 kg) / hour vapour
High pressure shut-off switch
230V/50 Hz, 300 W
TÜV approved
Part No 4493886

PLUS-8

本修复站适用于所有制冷剂，包括R410A无油压缩机1/2马力，无须保修。
结构坚固
压力计级别1.6
自动修复液体和蒸汽制冷剂
使用便利
自动净化功能
内置过滤器，便于清洁与更换

便携式，轻型：28磅（12公斤）
尺寸：38 x 20 x 35 厘米
修复率：
720磅（327公斤）/小时压拉
180磅（82公斤）/小时液体状
75磅（35公斤）/小时蒸汽状
高压关闭开关
230伏/50赫兹，300瓦
TÜV批准
部件号 4493886



PLUS-12

PLUS-12

The economical recovery station PLUS-12 combines an innovative refrigerant gas compressor system with a rugged, molded case that is designed to offer maximum protection from damage during transit and normal handling. PLUS-12 is also equipped with an inlet pressure regulator to prevent overpressure with liquid refrigerant. The unit is suitable for all refrigerants, including R410A.

Technical Data:

Compressor: 1/3 HP, oil-less maintenance free
Power supply: 220/240 V, 50/60 Hz
Weight: 11 kg
Dimensions: 39 x 25 x 40 cm
Recovery rates:
Vapour rate: up to 20 kg/h
Liquid rate: up to 50 kg/h
Push-pull rate: up to 250 kg/h
Part No 4660214

PLUS-12

简约型回收机适用于所有冷媒包括R410A，此革新设计结合强健粗野外型可于正常操用及运输途中作出最佳之保护作用于入口处配备压力调节器，能防止压力过大产生危险。

技术数据:

压缩机：1/3 HP 不需压缩机油式
电源供应：220/240伏，50/60赫兹
重量：11公斤
尺寸：39 x 25 x 40厘米
回收功率：
气体：可致20公斤/小时
液体：可致50公斤/小时
推动力：可致250公斤/小时
部件号 4660214



12900

12900

The compact unit with charging scale and interchangeable refrigerant scales.

The unit consists of:

- RL-2 Vacuum pump
- Electronic charging scale REF-METER
- Accuracy: +/- 0.5 %
- Range 0 to 100 kg / 0 to 220 lbs
- Vacuum gauge 80 mm diameter
- Bourdon type gauges with interchangeable refrigerant scales for R12, R22, R502, R134a, R404A, R407A, R407C, R507
- Charging line set 36 inches, blue, red and yellow

Part No 4661546

12900

具有充气刻度计和可互换制冷剂度的密集型计量仪组合包括:

- RL-2 真空泵
- 电子充气刻度计 REF-METER
- 精确度 +/-0.5百分比
- 介于0至100公斤 / 0 至220磅
- 真空表直径80毫米
- 用的具有可互换制冷剂刻度计的布顿型计量表，供R12, R22, R502, R134a, R404A, R407A, R407C, R507
- 充气管组36英寸蓝色、红色、黄色

部件号 4661546

12910

Charging station as above but for refrigerant R410A

Consisting of:

- RL-2 vacuum pump
- Electronic charging scale REF-METER
- Accuracy +/- 0.5%
- Range 0 to 100 kg / 0 to 220 lbs
- Vacuum gauge 80 mm diameter
- Bourdon type gauge with refrigerant scales R410A
- Charging line set 36 inches, blue, red and yellow, connection 1/2"-20UNF

Part No 4661555

12910

和12900相同但是还可以供给R410A制冷剂使用:

- 本组合包括
- 电子充气刻度计REF-METER
- 精确度 +/- 0.5百分比
- 介于0至100公斤 / 0至220磅
- 真空表直径80毫米
- 布顿型计量表包括制冷剂R410A计量仪
- 充气管组36英寸，连接处1/2"-20 UNF 蓝色、红色、黄色

部件号 4661555

CHF

3382.00

2662.00

2214.00

2304.00

Charging Stations for Domestic Isobutan R600a + R134a
家用电器异丁烷 R600a+R134a 充气站

10964

10964

Designed for field service repair of all appliances charged with R600a (Isobutan) or R134a refrigerant produced for important manufacturers of household appliances.

The unit consists of:

- RL-2 high vacuum pump
- Electronic scale range 0 to 2000 g, digit 1g
- Vacuum gauge 80 mm diameter
- Compound gauge, Ø 68, -1 to +3 bar pressure with temperature scale for R600a refrigerant (Isobutan)
- Compound gauge, Ø 68, -1 to +10 bar pressure with temperature scale for R134a refrigerant
- 10612-5 Polyamid-Capillary-Hose
- 10612-50 Support device for liquid filling of R600a (Isobutan)
- 10612-2 Can valve for refrigerant
- All necessary charging hoses including one special hose of 5 meter length in order to prevent any R600a gas (Isobutan) in the working area. For safety reasons gas must be led through this hose into the outside.

Part No 4661563

10964

本充气站是为所有使用为重要家用电器生产厂家生产的R600a（异丁烷）R134a制冷剂的现场维修所设计

本机组包括：

- RL-2真空泵
- 0-2000克的电子计量仪，以1克为刻度数位
- 直径80毫米真空计
- 符合计量仪，直径68毫米，-1至+3巴压力及温度计用于R600a（异丁烷）
- 符合计量仪，直径68毫米，-1至+10巴压力及温度计用于R134a
- 10612-5聚酰胺毛细软管
- 10612-50液体充填R600a（异丁烷）支持装置
- 用于10612-2制冷剂的罐阀所有必须的充气软管，包括1条5米长的特殊软管，以杜绝工作现场任何R600a气体（异丁烷）出于安全考虑，气体必须通过这一软管引向外部。

部件号 4661563

CHF

1892.00



10612-50

10612-5

Polyamid-Capillary-Hose
Part No 9883425

10612-50

Support Device for liquid filling and charging of R600a (Isobutan) cans, in connection with electronic scale 10500.

Part No 9885074

10612-5

聚酰胺毛细软管
部件号 9883425

10612-50

支援设备 用于R600a（异丁烷）充液及充气罐，与电子计量仪10500连接。

部件号 9885074

19.80

145.00



10500

10500

Electronic Scale
Measuring range: 0-2000 g;
Accuracy ± 1g. Battery powered, digital readings.

Part No 9881782

10500

电子计量仪
测量范围：0-2000克；
准确度 ± 1克，电池供电，
数字显示

部件号 9881782

240.00



10612-R600a

10612-R600a

Refrigerant Can
Content 420 g Isobutan R600a.
99.5% purity.

Part No 9881424

10612-R600a

制冷剂罐
内装420克异丁烷R600a
纯度99.5%

部件号 9881424

58.00



10612-2

10612-2

Can Valve
Connection 1/4" SAE; suitable to all REFCO refrigeration cans of the serie 10612.

Part No 9881202

10612-2

罐阀
接头 1/4 SAE；适用于所有 [威科]10612系列制冷罐

部件号 9881202

21.20



M4-3-BSM-R600a

Charging Stations for Domestic Isobutan R600a + R134a

M4-3-BSM-R600a

4-Way Manifold Set

Consists of:

- 4-Way manifold with compound gauge, Ø 68, range -1 up to 3 bar pressure and temperature scale for R600a in centigrade Celsius, mounted vacuum gauge, diameter 80 mm, range 1000-0 mbar
 - 3 colour coded charging lines, blue, red, and yellow, length each 90 cm
 - 1 hose, red, length 25 cm
 - CL-10-R; to connect refrigerant can (Isobutan R600a) and manifold
 - Sturdy plastic case with inside foam
- Part No 9885061**

家用电器异丁烷 R600a+R134a 充气台

M4-3-BSM-R600a

四向复式接头配套

包括:

- 四向复式接头, 带有复合计量仪, 直径68, -1至3巴压力计及 R600a摄氏度温度计, 装有真空计, 直径80毫米, 1000-0毫巴
- 三色编码充气线, 蓝色、红色、和黄色, 长度各90厘米
- 一条软管, 红色, 长度25厘米
- CL-10-R; 连接制冷罐(异丁烷R600a)及复式接头
- 坚固塑料箱及箱内泡

部件号 9885061

CHF

467.00



M2-250-M-R600a

M2-250-M-R600a

Compound Gauge

Connection 1/8 NPT, Ø 68 mm

range -1 to +3 bar for pressure reading
temperatur scale -30 to +30 degree centigrade pointer adjustable via front screen
bourdon type gauge, class 1.6.

Part No 9385882

M2-250-M-R600a

复合计量仪

接头1/8NPT, 直径68毫米, 压力显示-1至+3巴, 温度计指针-30至+30摄氏度, 正面屏幕布顿(bourdon)型计量仪, 级别1.6。

部件号 9385882

36.00



PM2-200-M-R600a

PM2-200-M-R600a

Compound Gauge, blue

Connection 1/8 NPT (on special request available with 1/4 SAE), Ø 76 mm;
range -1 to 10 bar for pressure reading;
R290, R600 and R600A (Isobutan);
pointer adjustable from the outside;
Bellow-Gauge construction, class 1.

Part No 9886486

PM2-200-M-R600a

复合计量仪, 蓝色

接头1/8NPT, (应特别请求可提供1/4 SAE), 直径76毫米, 压力显示-1至+10巴, 摄氏度温度计用于R290, R600及R600a(异丁烷)可从外部调节指针。波纹管式结构计量仪, 级别1。

部件号 9886486

79.50



PM2-300-M-R600a

PM2-300-M-R600a

High Pressure Gauge, red

Connection 1/8 NPT (on special request available with 1/4 SAE), Ø 76 mm;
range -1 to 30 bar for pressure reading;
temperature scale degree centigrade for R290, R600 and R600a (Isobutan);
pointer adjustable from the outside;
Bellow-Gauge construction, class 1.

Part No 9886487

PM2-300-M-R600a

高压计量仪, 红色

接头1/8NPT, (应特别请求可提供1/4 SAE), 直径76毫米, 压力显示-1至+30巴, 摄氏度温度计用于R290, R600及R600a(异丁烷)可从外部调节指针。波纹管式结构计量仪, 级别1。

部件号 9886487

79.50



10859

10859 CL-197-Y-SP

Aeration Hose

5 meter hose to be used in connection with safety clamp device part no. 10858 to lead gas R600a (Isobutan) into the atmosphere and to prevent explosions.

Part No 9881865

10859 CL-197-Y-SP

通气软管

5米软管用于连接安全夹装置部件号10858, 以便将R600a气体(异丁烷)引向空气中并避免爆炸。

部件号 9881865

39.00



STARTEK-C

STARTEK-C

The new combustible Gas Leak Detector in the new successful design is the most technologically advanced of its kind.

The STARTEK-C's low power requirements, small size and high sensitivity combine to create a tool which is easy to handle and ultra effective at locating even the most difficult-to-find leaks.

The STARTEK-C's long life sensor will detect concentrations of combustible gases as low as 5 ppm. It is sensitive to all combustible gases.

The STARTEK-C also features a low sensitivity mode, enabling quick and easy location of large combustible gas leaks. Supplied in a sturdy plastic case.

Technical Data:

Dimensions: 150 x 34 x 55 mm
 Weight: 190 g
 Batteries: 2 x AA batteries
 Battery lifetime: 11 hours
 Sensitivity: less than 50 ppm(Propane, Isobutane, Methane)
 Sensor lifetime: less than 1 year normal use
 Operating temperature: 0-50 °C
 Warm-up time: 45 seconds (conditioned sensor)
 Calibration: automatic
 Response time: 5 seconds
 Reset time: 5 seconds or more, depend ing on gas concentration
 Probe length: 30 cm

Part No 4660664

STARTEK-C

最新敏感型气体检漏仪，低电量要求，轻巧，高敏感度结合工具，易于操作更能有效地感应洩漏来源，此型备有长寿命感应头集中感应燃气体低至5ppm，内置高效能而准确机械式抽气泵，能提供正确气流至感应器末端。此检漏仪，可检漏所有可燃气，能够容易快速地寻找洩漏位置。新款型号包装在坚固塑料箱内。

技术数据:

体积: 150 x 34 x 55毫米
 重量: 190克
 电池: 2 x AA电
 电池使用: 11小时
 精确度: 少於50ppm(最佳电池)
 感应器: 正常使用下少于1年
 温度: 0-50 °C
 准备时间: 45秒
 校对模式: 自动
 反应时间: 5秒
 重置时间: 5秒或以上，取决于气体集中情况
 探索器长度: 30厘米

部件号 4660664

ES-C

Replacement sensor
Part No 4660672

ES-C

探索头
部件号 4660672

STARTEK-C-CASE

Carrying case for STARTEK-C
Part No 4665593

STARTEK-C-CASE

便携式塑料箱
部件号 4665593



REF-METER

Electronic Charging Scale

REF-METER

REF-METER is a brand-new digital charging scale with all the benefits below:

- Modern design
- Compact and lightweight (2.5 kg)
- Sturdy construction for a long lifetime
- Large platform for big refrigerant cylinder
- Field calibratable
- Supplied in a practical pouch

Technical Data:

Capacity: 100 kg (220 lbs)
 Platform: 26.7 x 26.7 x 4.5 cm
 Accuracy: +/-0.5%
 Resolution: 2 g
 Power supply: 4 AAA batteries
 Battery lifetime: 30 hours
Part No 4665657

电子充气计量仪

REF-METER

REF-METER是一种全新的数字显示式充气计量仪

- 好处如下:
- 时尚的设计
 - 简洁又轻巧
 - 坚固又耐用
 - 可以供给大的冷煤罐所使用
 - 实用的套盒
 - 设有可较正功能

技术数据:

最重重量: 100公斤
 面积: 26.7 x 26.7 x 4.5 厘米
 精准度: +/- 0.5巴仙
 分辨能力: 2克
 电力供应: 4 AAA电池
 电池寿命: 30小时
部件号 4665657



REF-METER

CHF

656.00

133.00

29.00

553.00



10750

10445

Charging Cylinders heavy duty CFC, HCFC + HFC

REFCO charging cylinders are built in heavy duty execution in order to fulfill every requirement.

The Mini-Charging Cylinders are in height about 1/2 of the «Large» size.
Calibration metric.

The meaning of the letter «H» after the charging cylinder part number indicates that the unit is equipped with a heating element 220–240 V 50 + 60 Hz

Important:

Charging cylinder can only be used for the refrigerants indicated on the cylinderscale.

强力型充气罐 CFC, HCFC+HFC

[威科]充气罐具强力建制以便能够完成任何需求。微型充气罐高度大约为大型罐的1/2米制刻度。充气罐部份号之后的字母H表示该仪器组设置有220-240伏50+60周的加热成份。

重要说明:

充气罐仅可用于在气罐刻度计上所标明的制冷剂。

Designation 名称	Capacity 容量	Temperature Scale 温度计	Size 型别	Part No 部件号	
10445-R12	1100g/ 克	R12, R22, R502	Mini/ 微型	9881765	453.00
10445-H-R12	1100g/ 克	R12, R22, R502	Mini/ 微型	9881764	501.00
10445-R134a	1000g/ 克	R134a, R404A	Mini/ 微型	9881763	453.00
10445-H-R134a	1000g/ 克	R134a, R404A	Mini/ 微型	9881762	501.00
10750-R12	2200g/ 克	R12, R22, R502	Large/ 大型	9881753	571.00
10750-H-R12	2200g/ 克	R12, R22, R502	Large/ 大型	9881752	624.00
10750-R134a	2000g/ 克	R134a, R404A	Large/ 大型	9881751	571.00
10750-H-R134a	2000g/ 克	R134a, R404A	Large/ 大型	9881750	624.00
10750-H-R407C	2000g/ 克	R134a, R404A, R407C	Large/ 大型	9884538	624.00

CHF



Pressure Gauges
Vacuum Gauges

压力表
真空表

威科制造商
REFCO Manufacturing Ltd.
Industriestrasse 11
CH-6285 Hitzkirch (Switzerland)

Phone
Fax
info@refco.ch

+41 41 91972 82
+41 41 91972 83
www.refco.ch

General Information**Pressure scale:**

M	=	metric, bar
DS	=	double scale bar/psi
KPA	=	kPa/psi

Please indicate request on your order.

Temperature scale:

R12	=	R12/R22/R502
R134a	=	R134a/R404A/R507
R22	=	R22/R134a/R404A
R407C	=	R407C/R134a/R404A
CLIM	=	R22/R407C/R410A

Temperature scales for other than the above indicated refrigerants are available on request.

Pressure range of gauges**bar:**

Compound	-1 up to +10 bar
Pressure	-1 up to +30 bar

kPa:

Compound	-100 up to +1000 kPa
Pressure	-100 up to +3000 kPa

psi:

Compound	-30 up to +140 psi
Pressure	-30 up to +400 psi

R410A**bar:**

Compound	-1 up to +36 bar
Pressure	-1 up to +54 bar

kPa:

Compound	-100 up to +3600 kPa
Pressure	-100 up to +5400 kPa

psi:

Compound	-30 up to +520 psi
Pressure	-30 up to +780 psi

一般资料**压力计:**

M	=	公制、巴
DS	=	双级计量仪巴/ 每平方英寸
KPA	=	kPa/每平方英寸

请在订单上注明您的要求。

温度计:

R12	=	R12/R22/R502
R134a	=	R134a/R404A/R507
R22	=	R22/R134a/R404A
R407C	=	R407C/R134a/R404A
CLIM	=	R22/R407C/R410A

以上所未列出的制冷计量度计可应要求提供。

巴:

复合	-1 至 +10 巴
压力	-1 至 +30 巴

公斤 帕斯卡:

复合	-100 至 +1000 公斤 帕斯卡
压力	-100 至 +3000 公斤 帕斯卡

磅 平方英寸

复合	-30 至 +140 磅 平方英寸
压力	-30 至 +400 磅 平方英寸

R410A**巴:**

复合	-1 至 +36 巴
压力	-1 至 +54 巴

公斤 帕斯卡:

复合	-100 至 +3600 公斤 帕斯卡
压力	-100 至 +5400 公斤 帕斯卡

磅 平方英寸

复合	-30 至 +520 磅 平方英寸
压力	-30 至 +780 磅 平方英寸

Bellow Type Gauge Class 1

波纹管型计量表 1 级



R5-220



R5-320

Principle of Bellow Gauge

波纹管型计量表原理

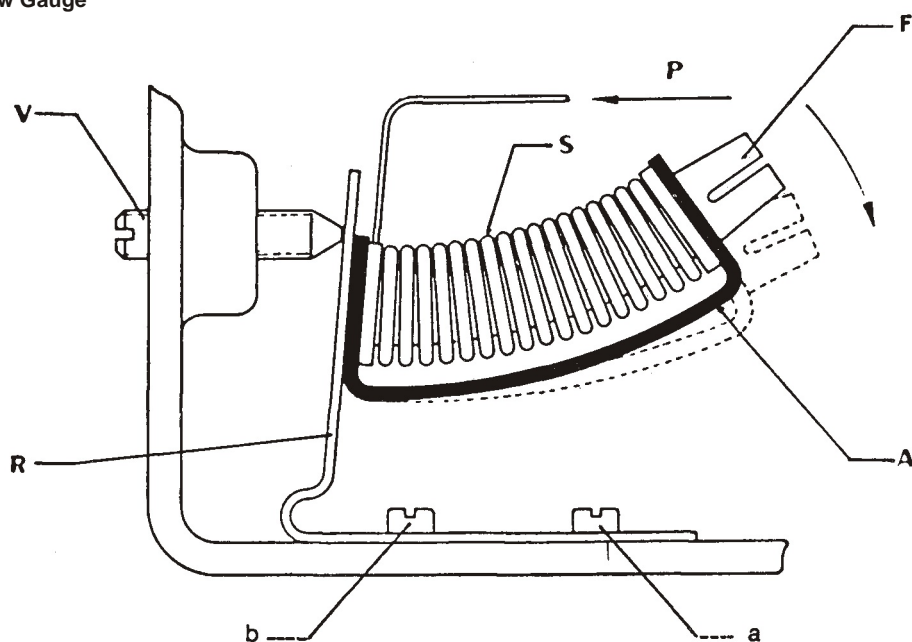

A – Steelspring
钢弹簧

R – Systemholder
系统整合件

V – Zero-Screw
零位螺丝

S – Metal-Bellow
金属波纹管

F – Workingfork
工作叉

P – Pressure inlet
压力输入管

The metal-bellow-type gauges are very sensitive and therefore absolutely accurate (class 1).

金属波纹管型计量表灵敏度很高，因而绝对精确（1级）。

The hardened steelspring **A** includes the brazed metal-bellow **S** and is under unload slightly bended (see drawing). This combination set is tied up with the system-holder **R**, which is mounted on the gauge-housing **a – b**.

加硬的钢弹簧**A**包括铜焊金属波纹管**S**，在无负荷状态下稍弯曲（见图）。该组合由系统整合件**R**束缚在一起，该整合件安装在计量表外壳**a-b**上。



++R5-300++

The workingfork **F** is connected with the gauge-mechanism. If pressure **P** is applied to the gauge the metal-bellow **S** will be activating the workingfork **F** and the pointer shows correct reading on the scale.

工作叉**F**与计量表机械连接。如果压力**P**作用于计量表，金属波纹管**S**将启动工作叉**F**，而指针将在仪表上显示出正确的读数。

Metal-bellow-type gauges are extremely over-pressure resistant and made according to accuracy class 1. If for instance on a compound gauge with a range from -1 to 10 bar respectively $-30 + 140$ psi an overpressure of 25 bar = 350 psi is applied the pointer will turn around $21\frac{1}{2}$ times. After release of the pressure the gauge is still in perfect condition and the pointer should only be slightly re-calibrated with the zero-screw **V**.

金属波纹管型极端抗过压，并根据精确度1级制造。例如，如果**25巴=350**平方英寸磅的过压作用于一个介于**-1至10巴-30+140**平方英寸磅的复合计量表上，指针将旋围**21/2**圈。

A Bourdon-type gauge would never stand such an over-pressure and would be destroyed.

在释放了压力之后，计量表仍完好无损，而指针也仅稍微偏离零位螺丝**V**。

布顿型计量表绝对不可能经受此种过压，将遭损坏。

Designation 名称	Pressure scale 压力计			Temperature Scale °C Centigrade 温度计摄氏度						Part No 部件号		
	bar*	kPa*	psi*	R12	R22	R502	R134a	R407C	R404A		R407	R410A
PM2-200-M-R12	●			●	●	●						9886375
PM2-300-M-R12	●			●	●	●						9886376
PM2-200-DS-R12	●		●	●	●	●						9886480
PM2-300-DS-R12	●		●	●	●	●						9886481
PM2-200-M-R134a	●						●		●	●		9886377
PM2-300-M-R134a	●						●		●	●		9886378
PM2-200-DS-R134a	●		●				●		●	●		9886465
PM2-300-DS-R134a	●		●				●		●	●		9886466
PM2-200-DS-R22	●		●		●		●		●			9884151
PM2-300-DS-R22	●		●		●		●		●			9884152
PM2-200-M-R407C	●						●	●	●			4411323
PM2-300-M-R407C	●						●	●	●			4411331
PM2-200-DS-R410A	●		●								●	9884097
PM2-300-DS-R410A	●		●								●	9884098

*bar – 巴 kPa – 公斤帕斯卡 psi – 平方英寸磅

**The low pressure range on the gauges is -1 to 36 bar/-30 to 520 psi, the high pressure range is -1 to 54 bar/-30 to 780 psi.



PM2-200



PM2-300

Important

All gauges with a diameter of 76 mm bottom connection 1/8" NPT. If 1/4" SAE flare connection is required it is important to put behind the part number 1/4" SAE; for instance PM2-200-1/4" SAE.

All gauges with 76 mm diameter are also available with back connection. Gauges with back connection are always 1/4" SAE.

If connection on the back is required please put on both sides of the part number the plus sign (+). For instance: ++PM2-200++.

重要说明:

所有直径76毫米的计量表, 底部连接为1/8英寸NPT。

如果需要使用1/4英寸SAE照明连接, 务必将1/4英寸SAE加在部件号之后。例如, PM2-200-1/4英寸SAE。

所有直径76毫米的计量表均提供背面连接。具有背面连接的计量表一概为1/4英寸SAE。

如果需要背面连接, 请在部件号两边加上(+)号。

如: ++PM2-200++

bar:
Compound -1 up to +10 bar
Pressure -1 up to +30 bar

kPa:
Compound -100 up to +1000 kPa
Pressure -100 up to +3000 kPa

psi:
Compound -30 up to +140 psi
Pressure -30 up to +400 psi

巴:
复合 -1 至 +10巴
压力 -1 至 +30巴

公斤帕斯卡:
复合 -100 至 +1000公斤帕斯卡
压力 -100 至 +3000公斤帕斯卡

磅平方英寸
复合 -30 至 +140 磅平方英寸
压力 -30 至 +400 磅平方英寸

CHF

79.50
79.50
79.50
79.50
79.50
79.50
79.50
79.50
79.50
79.50
79.50
79.50
106.00
106.00

**Bellow Types
Gauge Class 1
Aluminium housing**

波纹管型
计量表 1 级
铝制外壳



Designation 名称	Ø mm 直径 毫米	Connection 连接	Oil-filled 注油	Pressure scale 压力计					Temperature scale 温度计摄氏度				Part No 部件号	
				bar*	kPa*	psi*	R12	R22	R502	R134a	R404A	R507		R407C
R7-220-M-R12	100	1/4" SAE	●	●			●	●	●					9886410
R7-320-M-R12	100	1/4" SAE	●	●			●	●	●					9886411
R7-220-DS-R12	100	1/4" SAE	●	●	●		●	●	●					9886414
R7-320-DS-R12	100	1/4" SAE	●	●	●		●	●	●					9886415
R7-220-M-R134a	100	1/4" SAE	●	●						●	●	●		9886418
R7-320-M-R134a	100	1/4" SAE	●	●						●	●	●		9886419
R7-220-DS-R134a	100	1/4" SAE	●	●	●					●	●	●		9886422
R7-320-DS-R134a	100	1/4" SAE	●	●	●					●	●	●		9886423
R7-220-M-R407C	100	1/4" SAE	●	●						●	●		●	9884090
R7-320-M-R407C	100	1/4" SAE	●	●						●	●		●	9884091

CHF
236.00
236.00
236.00
236.00
236.00
236.00
236.00
236.00
236.00
236.00

*bar – 巴 kPa – 公斤帕斯卡 psi – 平方英寸磅

bar:
Compound –1 up to +10 bar
Pressure –1 up to +30 bar

kPa:
Compound –100 up to +1000 kPa
Pressure –100 up to +3000 kPa

psi:
Compound –30 up to +140 psi
Pressure –30 up to +400 psi

巴:
复合 –1 至 +10 巴
压力 –1 至 +30 巴

公斤帕斯卡:
复合 –100 至 +1000 公斤帕斯卡
压力 –100 至 +3000 公斤帕斯卡

磅平方英寸
复合 –30 至 +140 磅平方英寸
压力 –30 至 +400 磅平方英寸



++R7-220++



++R7-320++



R7-220



R7-320

Important

All gauges with a diameter of 60 and 80 mm, bottom connection 1/8" NPT. If 1/4" SAE flare connection is required it must be indicated behind the part number for instance R3-220-1/4" SAE. All gauges with 60, 80 and 100 mm diameter are also available with back connection. Gauges with back connection are always 1/4" SAE.

If connection on the back is required please put on both sides of the part number the plus sign (+). For instance: ++R3-220++

Special dials with other temperature-scales available on request; minimum quantity 100 pieces.

重要说明:

所有直径60和80毫米的计量表，底部连接为1/8英寸NPT。如果需要使用1/4英寸SAE照明连接，务必在部件号之后标明。例如，R3-220-1/4英寸SAE。所有直径60，80和100毫米的计量表均提供背面连接。具有背面连接的计量表一概为1/4英寸SAE。

如果需要背面连接，请在部件号两边加上(+)号。

如: ++R3-220++

其他温度计可应购货请求供货；起订量为100件。

Bourdon Type Gauges

布顿型计量表



MR-200

Bourdon type gauge Ø 63 mm, stainless housing, oilfilled, scale bar / psi, class 1.6, connection 1/4" SAE Ø 63 mm

布顿型计量表直径63毫米，不锈钢外壳，注油，巴/平方英寸磅刻度，级别1.6，连接为1/4英寸SAE直径63毫米。

Designation	Part No
MR-200-DS-R12	7645741
MR-300-DS-R12	7648571
MR-200-DS-R22	7648597
MR-300-DS-R22	7648601
MR-200-DS-R134a	7649232
MR-300-DS-R134a	7649372

名称	部件号
MR-200-DS-R12	7645741
MR-300-DS-R12	7648571
MR-200-DS-R22	7648597
MR-300-DS-R22	7648601
MR-200-DS-R134a	7649232
MR-300-DS-R134a	7649372

Gauges as above but with connection 1/8" NPT

表(含油设计) 脚部 1/8英寸NPT英制接口

Designation	Part No
MR-202-DS-R22	7413012
MR-302-DS-R22	7413020
MR-202-DS-R134a	7413046
MR-302-DS-R134a	7413098

名称	部件号
MR-202-DS-R22	7413012
MR-302-DS-R22	7413020
MR-202-DS-R134a	7413046
MR-302-DS-R134a	7413098

Gauges as above, ring for front mounting, backside connection 1/4" SAE

以上布顿式刻度计量仪为正面套圈安装，背面连接1/4英寸SAE

Designation	Part No
++MR-205-DS-R12++	7870524
++MR-305-DS-R12++	7870532
++MR-205-DS-R22++	7870443
++MR-305-DS-R22++	7870451
++MR-205-DS-R134a++	7870354
++MR-305-DS-R134a++	7870389

名称	部件号
++MR-205-DS-R12++	7870524
++MR-305-DS-R12++	7870532
++MR-205-DS-R22++	7870443
++MR-305-DS-R22++	7870451
++MR-205-DS-R134a++	7870354
++MR-305-DS-R134a++	7870389



++MR-305++

Gauges as above, but ring for back mounting, connection 1/4" SAE

表(含油设计)背面连接1/4英寸SAE接口有衬托，专为方便安装机组表板专用

Designation	Part No
MR-206-DS-R12	4503679
MR-306-DS-R12	4503687
MR-206-DS-R22	7196101
MR-306-DS-R22	7196119
MR-206-DS-R134a	4503695
MR-306-DS-R134a	4503708
MR-206-DS-R407C	7433650
MR-306-DS-R407C	7433693

名称	部件号
MR-206-DS-R12	4503679
MR-306-DS-R12	4503687
MR-206-DS-R22	7196101
MR-306-DS-R22	7196119
MR-206-DS-R134a	4503695
MR-306-DS-R134a	4503708
MR-206-DS-R407C	7433650
MR-306-DS-R407C	7433693



MR-206

bar:
Compound -1 up to +10 bar
Pressure -1 up to +30 bar

psi:
Compound -30 up to +140 psi
Pressure -30 up to +400 psi

巴:
复合 -1 至 +10巴
压力 -1 至 +30巴

磅平方英寸
复合 -30 至 +140 磅平方英寸
压力 -30 至 +400 磅平方英寸

CHF

37.00
37.00
37.00
37.00
37.00
37.00

37.00
37.00
37.00
37.00

41.50
41.50
41.50
41.50
41.50
41.50

41.00
41.00
41.00
41.00
41.00
41.00
41.00
41.00



19800-SV

19800-SV

Vacuum Gauge with safety valve
Diameter 80 mm, connection 1/8" NPT,
recalibratable, scale 1000-0 mbar
Part No 9882473

19800-SV

真空表及安全阀
直径80毫米，连接为1/8英寸NPT，
可重新校准，刻度为1000至0毫巴
部件号 **9882473**

CHF

112.00



19805-12

19805-12/5

Safety valve only, ready for use on item
19800-SV, 19801, 19805.
Part No 9884867

19805-12/5

单件安全阀，可用于部件
19800-SV, 19801, 19805。
部件号 **9884867**

32.50



19801

19801

Vacuum Gauge 1000 to 0 mbar
Diameter: 100 mm
Connection: 1/2" G
With maxi-reading gauge pointer indicates
maximum pressure reading attained
during any given period. Readjust with
thumb screw.
Part No 9882474

19801

真空计1000至0毫巴
直径：100毫米
连接：1/2英寸 G
配有最大读数仪表指针
指示任一指定期间所达
到的最大压力读数。可
以指旋螺丝重新调节。
部件号 **9882474**

161.00



19621

19621

Absolute-Vacuum Gauge
reading from 150 to 0 mbar
Diameter: 100 mm
Connection: 1/2" G. Including adapter
1/2" G x 1/4" SAE (Art. 19803). This instrument
does compensate the atmospheric
pressure, therefore the effective vacuum
will be measured.
Part No 9882476

19621

绝对真空表
读数从150至0毫巴
直径：100毫米
连接：1/2英寸G，包括调节器
1/2英寸G x 1/4英寸SAE
(项目 19803)。
本表并不补偿气压，因此，有
效真空将得到测量。
部件号 **9882476**

724.00

Vacuum Gauge Electronic

真空电子计量表



DV-150

DV-150

Electronic vacuum gauge measures from atmospheric pressure to absolute vacuum.

Extent of delivery:

Electrical Vacuum Gauge complete with bag, 9 Volt batterie connection (batterie included) measures Atm. to 50 micron = 0.06 mbar
Part No 9881862

DV-150

电子真空表进行从大气压到绝对真空的测量。

交货项目:

全套电子真空表及包装袋, 9伏特电池接头(包括电池)
大气测量50微米=0.06巴

部件号 **9881862**

CHF

442.00



VG-64

VG-64

Digital Vacuum Gauge

- Resolution 1 Micron (when vacuum 200 Micron)
 - Reads Vacuum in 7 units: Micron, PSI, InHg, mbar, Pascal, Torr, mTorr
 - Hook
 - Cleaning port for cleaning of sensor
 - Accuracy +/- 10% from 10-99micron
 - +/- 10 micron from 100-1000 micron
 - Overpressure 20 bar
- Part No 4503171**

VG-64

数字式电子真空计
准确精度: 1毫米
(当真空量 200毫米)
具有7种真空单位显示

精确度: +/- 10%由10-99微米
+/- 10微米由100-1000微米
最大压力20巴
部件号 **4503171**

569.00



RL-VAC

RL-VAC

Vacuum gauge set with ball valve 1/4" SAE for vacuum pumps.
Part No 4663981

RL-VAC

真空表连接1/4" SAE
球阀用于真空泵
部件号 **4663981**

136.00

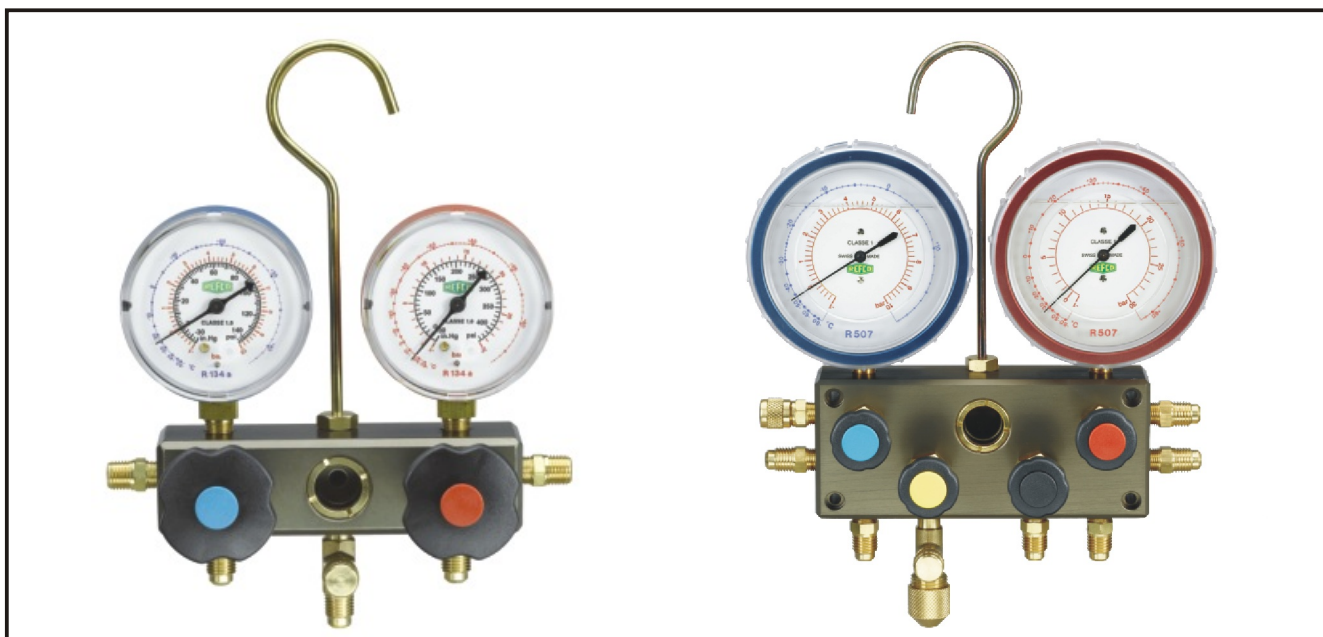

Manifolds
Hoses
Valves
Connectors

复式接头
软管
阀
接口

威科制造商
REFCO Manufacturing Ltd.
Industriestrasse 11
CH-6285 Hitzkirch (Switzerland)

Phone
Fax
info@refco.ch

+41 41 91972 82
+41 41 91972 83
www.refco.ch

General Information**Pressure scale:**

M	=	metric, bar
DS	=	double scale bar/psi
KPA	=	kPa/psi

Please indicate request on your order.

Temperature scale:

R12	=	R12/R22/R502
R134a	=	R134a/R404A/R507
R22	=	R22/R134a/R404A
R407C	=	R407C/R134a/R404A
CLIM	=	R22/R407C/R410A

Temperature scales for other than the above indicated refrigerants are available on request.

Pressure range of gauges

bar:

Compound -1 up to +10 bar
Pressure -1 up to +30 bar

kPa:

Compound -100 up to +1000 kPa
Pressure -100 up to +3000 kPa

psi:

Compound -30 up to +140 psi
Pressure -30 up to +400 psi

R410A

bar:

Compound -1 up to +36 bar
Pressure -1 up to +54 bar

kPa:

Compound -100 up to +3600 kPa
Pressure -100 up to +5400 kPa

psi:

Compound -30 up to +520 psi
Pressure -30 up to +780 psi

一般资料

压力计:

M	=	公制、巴
DS	=	双级计量仪巴/ 每平方英寸
KPA	=	kPa/每平方英寸

请在订单上注明您的要求。

温度计:

R12	=	R12/R22/R502
R134a	=	R134a/R404A/R507
R22	=	R22/R134a/R404A
R407C	=	R407C/R134a/R404A
CLIM	=	R22/R407C/R410A

以上所未列出的制冷计量度计可应要求提供。

巴:

复合 -1 至 +10 巴
压力 -1 至 +30 巴

公斤 帕斯卡:

复合 -100 至 +1000 公斤 帕斯卡
压力 -100 至 +3000 公斤 帕斯卡

磅 平方英寸

复合 -30 至 +140 磅 平方英寸
压力 -30 至 +400 磅 平方英寸

R410A

巴:

复合 -1 至 +36 巴
压力 -1 至 +54 巴

公斤 帕斯卡:

复合 -100 至 +3600 公斤 帕斯卡
压力 -100 至 +5400 公斤 帕斯卡

磅 平方英寸

复合 -30 至 +520 磅 平方英寸
压力 -30 至 +780 磅 平方英寸

Super-Manifold-Set with «SNAP-ON» System

超级复式接头组 «撇入式»系统

M4-3-SUPER

Pressure scale:

M = metric, bar
 DS = double scale bar/psi
 KPA = kPa/psi
 Please indicate request on your order.

压力计

M=公制巴
 DS=二级(双表)计量仪, 巴/每平方英寸磅
 KPA=公斤帕斯卡/每平方英寸磅
 请在订单上注明具体要求。

The first Manifolds for all refrigerants.

所有制冷剂的首选复式接头

These Manifolds offer an easier reading of each temperature scale. The unique «SNAP-ON»-System allows a quick change of the scales depending on the used refrigerant – no more mix-up of temperatures because there is always only one scale in use.

这些复式接头便于您读取各温度计。独特的«撇入式»系统可使您根据所使用的制冷剂快速更换仪表。由于始终仅使用一个仪表, 所以不再有温度混淆的问题。

As soon as new refrigerants appear on the market – only new scales have to be purchased. Even longer lifetime of REFCO-Manifolds.

一旦新制冷剂在市场出现, 只需购买新的仪表。[威科]复式接头的使用寿命将更长久。

The Manifold is supplied including 8 different temperature scales for:

复式接头在供货时包括8个不同的温度计, 用于: R12、R22、R502、R134a、R404A、R407A、R407C、R507, 均可于低压和高压。

R12, R22, R502, R134a, R404A, R407A, R407C, R507; each for low and high pressure.

其他温度计可另行按价供货。

Further temperature scales are available at additional costs.

项目内容将随时更新。

The range will be constantly updated.

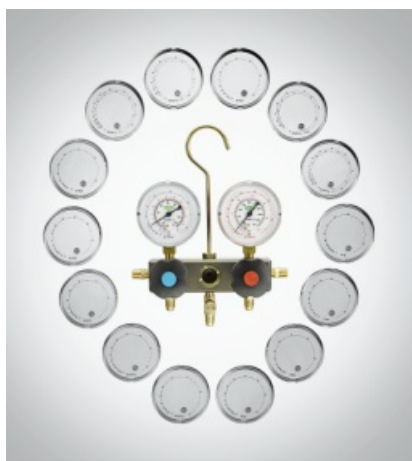
BM2-3-SUPER

BM2-3-SUPER

Super-Manifold-Set with 《SNAP-ON》 System

超级复式接头组 《揷入式》系统

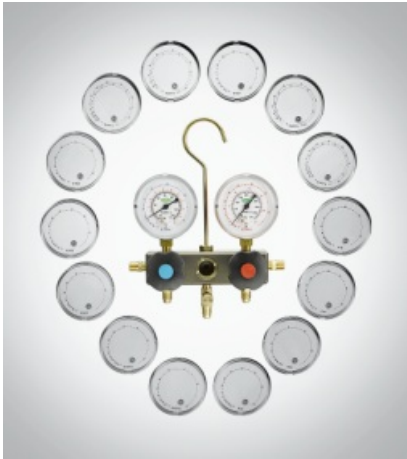

BM2-3-SUPER

BM2-3-SUPER Manifold

2-way manifold with bourdon type gauges, including 8 《SNAP-ON》 temperature scales, hook, 3 color coded charging lines 1/4" SAE blue, red and yellow, length 36 inches (90 cm) packed in a sturdy plastic case.

BM2-3-DS-SUPER

with gauges pressure scale DS
Part No 9883537

BM2-3-KPA-SUPER

with gauges pressure scale kPa/psi
Part No 9882973

BM4-3-SUPER

4-way manifold with bourdon type gauges, including 8 《SNAP-ON》 temperature scales, hook, 3 charging lines 1/4" SAE blue, red and yellow, length 36 inches (90 cm), in a sturdy plastic case.

BM4-3-DS-SUPER

with gauges pressure scale DS
Part No 9883717

BM4-3-KPA-SUPER

with gauges pressure kPa/psi
Part No 9883876



BM2-3-SUPER

Temperature-Scale R50

温度计 R50

R-50-R12-BP/HP

R-50-R22-BP/HP

R-50-R134a-BP/HP

R-50-R404A-BP/HP

R-50-R407A-BP/HP

R-50-R407C-BP/HP

R-50-R502-BP/HP

R-50-R507-BP/HP

R-50-R600a-BP/HP

R-50-SET/组件

(Scale set 8 pieces)/(温度计组8件):

R12, R22, R502, R134a, R404A, R407A, R407C, R507

M2-250-DS-SUPER

Compound Gauge

Ø 68 mm

Connection 1/8" NPT

Part No 7014732

M2-500-DS-SUPER

Pressure Gauge

Part No 7015194

M2-250-KPA-SUPER

Compound Gauge

Part No 7014473

M2-500-KPA-SUPER

Pressure Gauge

Part No 7014619

BM2-3-SUPER 超级复式接头

用于布顿 (Bourdon) 型计量表的双向复式接头, 包括8个《揷入式》温度计、吊钩、三色编号充气线、1/4英寸SAE蓝色、红色及黄色。长度36英寸(90厘米), 包装于坚固的塑料箱中。

BM2-3-DS-SUPER

用于计量表压力计DS
部件号 9883537

BM2-3-KPA-SUPER

用于计量表压力计公斤帕斯卡/每平方英寸磅
部件号 9882973

BM4-3-SUPER

用于布顿 (Bourdon) 型计量表的双向复式接头, 包括8个《揷入式》温度计、吊钩、三色编号充气线、1/4英寸SAE蓝色、红色及黄色。长度36英寸(90厘米), 包装于坚固的塑料箱中。

BM4-3-DS-SUPER

用于计量仪压力表DS
部件号 9883717

BM4-3-KPA-SUPER

用于计量仪压力表公斤帕斯卡/每平方英寸磅
部件号 9883876

Part No.

部件号

9882974

9882975

9882977

9882978

9882979

9882980

9882976

9882981

9884979

9883334

CHF

317.00

317.00

422.00

422.00

11.20

11.20

11.20

11.20

11.20

11.20

11.20

11.20

11.20

89.50

38.00

38.00

38.00

38.00

Super-Manifold-Set with 《SNAP-ON》 System

超级复式接头 用于《插入式》系统

M2-3-DELUXE-SUPER
M2-3-G-SUPER

Manifold 2-Way
Complete in sturdy case, oil filled bellow type gauges Ø 80 mm, 3 pieces colour coded 1/4" SAE charging lines of 36 inches (90 cm) length, separate case with 8 pieces 《SNAP-ON》 temperature scales.

M2-3-DELUXE-M-SUPER

with gauges pressure scale M
Part No 9883250

M2-3-DELUXE-DS-SUPER

with gauges pressure scale DS
Part No 9885055

M2-3-DELUXE-KPA-SUPER

with gauges pressure scale kPa/psi
Part No 9883661

M2-3-G-SUPER

双向复式接头
成套包装于坚固的包装箱中，注油波纹式计量表，直径80毫米，三色编号充气线、1/4英寸SAE。长度36英寸（90厘米）。另箱包装8件《插入式》温度计。

M2-3-DELUXE-M-SUPER

用于计量表压力计M
部件号 9883250

M2-3-DELUXE-DS-SUPER

用于计量表压力计DS（双表）
部件号 9885055

M2-3-DELUXE-KPA-SUPER

用于计量表压力计公斤帕斯卡/每平方英寸磅
部件号 9883661

M4-3-DELUXE-M-SUPER
M4-3-SUPER

Complete in sturdy case, oil filled bellow type gauges Ø 80 mm, 3 pieces colour coded 1/4" SAE charging lines of 36 inches (90 cm) length and one 3/8" SAE yellow vacuum line 36 inches (90 cm) length, separate case with 8 pieces 《SNAP-ON》 temperature scales.

M4-3-DELUXE-M-SUPER

with gauges pressure scale M
Part No 9885047

M4-3-DELUXE-DS-SUPER

with gauges pressure scale DS
Part No 9883332

M4-3-DELUXE-KPA-SUPER

with gauges pressure scale kPa/psi
Part No 9883333

M4-3-SUPER

双向复式接头
成套包装于坚固的包装箱中，注油波纹式计量表，直径80毫米，三色编号充气线、1/4英寸SAE，长度36英寸（90厘米）。一条3/8英寸SAE黄色真空线。长度36英寸（90厘米）。另箱包装8件《插入式》温度计。

M4-3-DELUXE-M-SUPER

用于计量表压力计M
部件号 9885047

M4-3-DELUXE-DS-SUPER

用于计量表压力计DS（双表）
部件号 9883332

M4-3-DELUXE-KPA-SUPER

用于计量表压力计公斤帕斯卡/每平方英寸磅
部件号 9883333

CHF

582.00

582.00

582.00

669.00

669.00

669.00



R-52-HP/BP

To be used with 《SNAP-ON》 Manifolds M2 and M4 as well as for REFCO gauges R5-240 and R5-340, oil filled with diameter 80 mm in execution for low and high pressure.
This System is not only new and unique but also worldwide patented and allows the user to change the scales fast and easy.

R-52-R12-BP/HP
R-52-R14-BP/HP
R-52-R22-BP/HP
R-52-R23-BP/HP
R-52-R134a-BP/HP
R-52-R290-BP/HP
R-52-R401A-BP/HP
R-52-R402A-BP/HP
R-52-R404A-BP/HP
R-52-R407A-BP/HP
R-52-R407B-BP/HP
R-52-R407C-BP/HP
R-52-R408A-BP/HP
R-52-R409A-BP/HP
R-52-R410A-BP/HP
R-52-R413A-BP/HP
R-52-R417A-BP/HP
R-52-R502-BP/HP
R-52-R503-BP/HP
R-52-R507-BP/HP
R-52-R600-BP/HP
R-52-R600a-BP/HP

9882207
9883587
9882209
9882211
9882215
9882229
9882217
9883581
9882219
9882221
9882223
9882225
9883851
9883881
9883956
9883742
4493177
9882235
9883408
9882227
9882231
9882233

CHF

16.60
16.60
16.60
16.60
16.60
16.60
16.60
16.60
16.60
16.60
16.60
16.60
16.60
16.60
16.60
16.60
16.60
16.60
16.60
16.60
16.60
16.60
16.60
16.60



M4-52/53

M4-52/53

Scale Set complete in sturdy plastic case including 8 sets of temperature scales as: R134a, R22, R401A, R404A, R407A, R407C, R410A, R507 or as per customers request.

Part No 9882201

R5-240

Compound Gauge, Ø 80 mm, oil filled 1/8" NPT connection

R5-240-M

with pressure scale M

Part No 9886386

R5-240-DS

with pressure scale DS

Part No 9886388

R5-240-KPA

with pressure scale kPa/psi

Part No 9886493

R5-340

Pressure Gauge
Ø 80 mm, oil filled 1/8" NPT connection

R5-340-M

with pressure scale M

Part No 9886387

R5-340-DS

with pressure scale DS

Part No 9886389

R5-340-KPA

with pressure scale kPa/psi

Part No 9886494

R5-340



与M2及M4《插入式》复式接头使用，以及用于[威科]计量表R5-240及R5-340，注油，直径80毫米，可用于低压及高压。

本系统不仅新颖独特，而且拥有全世界专利，使用户能快速便利地更换仪表。

M4-52/53

成套仪表组件置于坚固塑料箱中，包括8件温度计：R134a, R22, R401A, R404A, R407A, R407C, R410A, R507，或应客户要求提供。

部件号 9882201

R5-240

复合计量表，直径80毫米，注油1/8英寸NPT接头。

R5-240-M

用于压力计M

部件号 9886386

R5-240-DS

用于压力计DS

部件号 9886388

R5-240-KPA

用于压力计公斤帕斯卡/每平方英寸磅

部件号 9886493

R5-340

压力表
直径80毫米，注油1/8英寸NPT接头

R5-340-M

用于压力计M

部件号 9886387

R5-340-DS

用于压力计DS

部件号 9886389

R5-340-KPA

用于压力计公斤帕斯卡/每平方英寸磅

部件号 9886494

120.00

172.00

172.00

172.00

172.00

172.00

172.00

Gauges, Manifolds and Charging lines for the new refrigerant R410A

Units charged with R410A require gauges with higher pressure ranges as well as hoses with different connections and working pressures. The standard connection for R410A is 1/2"-20 UNF (5/16"SAE). The red and blue REFCO charging lines are equipped with a connection 1/2"-20 UNF. On the manifold side they have 1/4" SAE connection. The yellow charging lines have 1/4" SAE connection with core depressor on both sides. The working pressure of the charging lines is 60 bar / 870 psi.

The low pressure range on the gauges is -1 to 36 bar/-30 to 520 psi, the high pressure range is -1 to 54 bar/-30 to 780 psi.



M2-255-DS-R410A

Gauges

M2-255-DS-R410A
Compound bourdon type gauge class 1.6, Ø 68 mm, connection 1/8" NPT
Part No 7455896

M2-555-DS-R410A
As above, but pressure gauge
Part No 7456001

用于新制冷剂R410A的计量表、复式接头及充气线

以R410A充气的机组要求计量表具备更高的压力范围，其软管具备不同的接头和压力。标准的R410A接头为 1/2 英寸-20 UNF (5/16英寸SAE)。红色和蓝色[威科]充气线配备有 1/2 英寸-20 UNF接头，在机组部分装有核心降压器，复式接头部分装有 1/4 英寸SAE。黄色充气线有 1/4 英寸SAE接头，两头均装有核心压缩器，充气线施加压力为60巴/870平方英寸磅。

计量表的低压范围为-1至-36巴/-30至520平方英寸磅；高压范围为-1至54巴/-30至780平方英寸磅。

计量表

M2-255-DS-R410A
复合bourdon型计量表，1.6级，直径68毫米，接头 1/8 英寸NPT
部件号 7455896

M2-555-DS-R410A
同上，为压力表
部件号 7456001



PM2-200-DS-R410A

PM2-200-DS-R410A
Compound bellow gauge class 1.0, Ø 76 mm, connection 1/8" NPT
Part No 9884097

PM2-300-DS-R410A
As above, but pressure gauge
Part No 9884098

PM2-200-DS-R410A
复合波纹管式计量表，1.0级，直径76毫米，接头 1/8 英寸NPT
部件号 9884097

PM2-300-DS-R410A
同上，为压力表
部件号 9884098



R3-220-DS-R410A

R3-220-DS-R410A
Compound bellow gauge class 1.0, oil-filled, Aluminium housing, Ø 60 mm,
Part No 4457049

R3-320-DS-R410A
As above, but pressure gauge
Part No 4457057

R3-220-DS-R410A
复合波纹管式计量表，1.0级，注油，铝制外壳，直径60毫米
部件号 4457049

R3-320-DS-R410A
同上，为压力表
部件号 4457057

CHF

45.00

45.00

106.00

106.00

177.00

177.00

Manifolds R410A



BM2-3-DS-R410A

BM2-3-DS-R410A

Two-way manifold with Bourdon type gauges, hook, 3 charging lines connection 1/2" -20UNF (blue, red) and 1/4" SAE (yellow), length 36 inches (90 cm), in a sturdy plastic case

Part No 9884707

M2-3-DS-R410A

Two-way manifold with standard bellow type gauges class 1, hook, 3 charging lines connection 1/2" -20UNF (blue, red) and 1/4" SAE (yellow), length 36 inches (90 cm), in a sturdy plastic case

Part No 9884093

M2-3-DELUXE-DS-R410A

Two-way manifold with oilfilled bellow type gauges class 1, hook, 3 charging lines connection 1/2" -20UNF (blue, red) and 1/4" SAE (yellow), length 36 inches (90 cm), in a sturdy plastic case

Part No 9884239

M4-3-DS-R410A

Four-way manifold with standard bellow type gauges class 1, hook, 3 charging lines connection 1/2" -20UNF (blue, red) and 1/4" SAE (yellow), length 36 inches (90 cm), in a sturdy plastic case

Part No 9884092

M4-3-DELUXE-DS-R410A

Four-way manifold with oilfilled bellow type gauges class 1, hook, 3 charging lines connection 1/2" -20UNF (blue, red) and 1/4" SAE (yellow), length 36 inches (90 cm), in a sturdy plastic case

Part No 9884234



M4-3-DELUXE-DS-R410A

Manifolds R22, R407C, R410A

BM2-3-DS-CLIM

Two-way manifold with Bourdon type gauges, hook, 3 charging lines 1/4" SAE blue, red and yellow, length 36 inches (90 cm), as well as two charging lines (blue and red) length 36 inches (90 cm) with 1/2" -20UNF connection on one end, packed in a sturdy plastic case

Part No 4663506

BM2-6-DS-CLIM

Two-way manifold with Bourdon type gauges, hook, 3 charging lines 1/4" SAE blue, red and yellow, length 36 inches (90 cm), as well as two charging lines (blue and red) length 36 inches (90 cm) with 1/2" -20UNF connection on one end, packed in a card board box

Part No 4663298

BM2-8-DS-CLIM

Two-way manifold with Bourdon type gauges, hook, without accessories, packed in a card board box.

Part No 4664015



BM2-8-DS-CLIM

复式接头R410A

BM2-3-DS-R410A

用于Bourdon型计量表的双向复式接头，包括吊钩、三条编号充气线接头、1/2英寸-20UNF（蓝色、红色）及1/4英寸SAE（黄色），长度36英寸（90厘米），包装于坚固的塑料箱中。

部件号 9884707

M2-3-DS-R410A

用于标准波纹管式型计量表的双向复式接头，1级，包括吊钩、三条编号充气线接头1/2英寸-20 UNF（蓝色、红色）及1/4英寸SAE（黄色）。长度36英寸（90厘米），包装于坚固的塑料箱中。

部件号 9884093

M2-3-DELUXE-DS-R410A

用于注油波纹管式型计量表的双向复式接头，1级，包括吊钩、三条编号充气线接头1/2英寸-20 UNF（蓝色、红色）及1/4英寸SAE（黄色）。长度36英寸（90厘米），包装于坚固的塑料箱中。

部件号 9884239

M4-3-DS-R410A

用于标准波纹管式型计量表的四向复式接头，1级，包括吊钩、三条编号充气线接头1/2英寸-20 UNF（蓝色、红色）及1/4英寸SAE（黄色）。长度36英寸（90厘米），包装于坚固的塑箱中。

部件号 9884092

M4-3-DELUXE-DS-R410A

用于注油波纹管式型计量表的四向复式接头，1级，包括吊钩、三条编号充气线接头1/2英寸-20 UNF（蓝色、红色）及1/4英寸SAE（黄色）。长度36英寸（90厘米），包装于坚固的塑箱中。

部件号 9884234

复式接头 R22, R407C, R410A

BM2-3-DS-CLIM

双向复式接头配有布顿式仪表，挂钩，三条充气管，接头1/4英寸SAE，配有蓝色、红色、黄色，长度36英寸（90厘米），以及另外两条（蓝、红）的充气管，长36英寸（90厘米）1/2英寸-20 UNF接头，包装于坚固塑料箱中。

部件号 4663506

BM2-6-DS-CLIM

基本上与 BM2-3-DS-CLIM 无异，放于纸盒内

部件号 4663298

BM2-8-DS-CLIM

双向复式接头，配有布顿式仪表，挂钩，但是没有其他配件在盒子里。

部件号 4664015

CHF

275.00

407.00

549.00

509.00

603.00

316.00

267.00

188.00

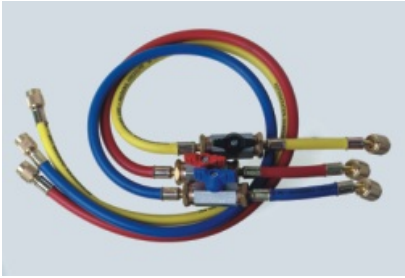

CCL-36-1/2"-20 UNF-1/4" SAE

Charging lines for R410A

The red and blue REFCO charging lines are equipped with a connection 1/2"-20 UNF. On the manifold side they have 1/4" SAE connection. The yellow charging lines have 1/4" SAE connection with core depressor on both sides. The working pressure of the charging lines is 60 bar / 870 psi.

R410A 充气线

红色和蓝色[威科]充气线配备有1/2英寸-20UNF接头。复式接头部份装有1/4英寸SAE。黄色充气线有1/4英寸SAE接头，两头均装有核心压缩机。充气线施加压力为60巴/870（平方英寸磅）。

CHF

Set of 3 pieces

每套三条

Designation 名称	Length	长度	Part No 部件号
CCL-36-1/2" -20 UNF	36 inches/英寸	90 cm/厘米	9884094
CCL-60-1/2" -20 UNF	60 inches/英寸	150 cm/厘米	9884095

70.00
92.50

Hoses with CX-valves

配CX阀软管

Set of 3 pieces

每套三条

Designation 名称	Length	长度	Part No 部件号
CCL-36-CX-1/2" -20 UNF	36 inches/英寸	90 cm/厘米	9884096

187.00

Single Charging Lines

单条充气线

Designation 名称	Length	长度	Part No 部件号	
			B	R
CL-36-1/2" -20 UNF	36 inches/英寸	90 cm/厘米	9884076	9884077
CL-60-1/2" -20 UNF	60 inches/英寸	150 cm/厘米	9884621	9884622

25.40
33.50

QC-S410A

QC-S410A

Adapter with core depressor,
1/4" SAE x 1/2" -20 UNF
Part No 9884931

QC-S410A

与核心降压器的接合器，
1/4" SAE x 1/2 英寸-20 UNF
部件号 9884931

27.60

Manifolds

复式接头



APEX-8

APEX-8
Manifold with bourdon type gauges, hook, without accessories, packed in a cardboard box

APEX-8-DS-R12	Part No 4666360
APEX-8-DS-R134a	4667277

APEX-8
复式接头及bourdon式仪表，挂钩，无附件，包装于纸箱中

	部件号	
APEX-8-DS-R12	4666360	108.00
APEX-8-DS-R134a	4667277	108.00

CHF



APEX-6

APEX-6
Manifold with Bourdon type gauges, hook, 3 charging lines 1/4" SAE blue, red and yellow, length 36 inches (90 cm), packed in a cardboard box

	Part No
APEX-6-DS-R12	4667286
APEX-6-DS-R134a	4667294

APEX-6
复式接头及布顿式仪表，挂钩，三条编号充气线接头1/4英寸SAE，蓝色、红色及黄色，长度36英寸（90厘米），包装于纸箱中。

	部件号	
APEX-6-DS-R12	4667286	158.00
APEX-6-DS-R134a	4667294	158.00

158.00
158.00

APEX-3
with bourdon type gauges, hook, 3 charging lines 1/4" SAE blue, red, and yellow, length 36 inches (90 cm), in a sturdy plastic case

	Part No
APEX-3-DS-R12	4667553
APEX-3-DS-R134a	4667561

APEX-3
配有布顿式仪表，挂钩，三条编号充气线接头1/4英寸SAE，蓝色、红色及黄色，长度36英寸（90厘米），包装于坚固的塑料箱中。

	部件号	
APEX-3-DS-R12	4667553	191.00
APEX-3-DS-R134a	4667561	191.00

191.00
191.00

Two-way standard manifold with sight glass

High quality aluminium body with sight glass

标准双向复式接头配有透视玻璃

高质量铝制本体配有透视玻璃



BM2-8-DS

BM2-8

Bourdon type gauges, hook, without accessories, packed in cardboard box

BM2-8

布顿式计量表，挂钩，无附件，包装于纸箱中。

	Part No
BM2-8-DS-R12-N	9883507
BM2-8-M-R134a	9883715
BM2-8-DS-R134a	9883336
BM2-8-DS-R470C	4503503
BM2-8-M-R22-R134a	9884895
BM2-8-DS-R22	9884896

	部件号	152.00
BM2-8-DS-R12-N	9883507	152.00
BM2-8-M-R134a	9883715	152.00
BM2-8-DS-R134a	9883336	152.00
BM2-8-DS-R470C	4503503	152.00
BM2-8-M-R22-R134a	9884895	152.00
BM2-8-DS-R22	9884896	152.00

BM2-6

with bourdon type gauges, hook, 3 charging lines 1/4" SAE blue, red, and yellow, length 36 inches (90 cm), packed in a cardboard box

BM2-6

配有布顿式仪表，挂钩，三条编号充气线接头1/4英寸SAE，蓝色、红色及黄色，长度36英寸（90厘米），包装于纸箱中。

	Part No
BM2-6-DS-R12-N	9883535
BM2-6-M-R134a	9883413
BM2-6-DS-R134a	9882142
BM2-6-DS-R407C	4503520
BM2-6-M-R22-R134a	9884897
BM2-6-DS-R22	9884898

	部件号	198.00
BM2-6-DS-R12-N	9883535	198.00
BM2-6-M-R134a	9883413	198.00
BM2-6-DS-R134a	9882142	198.00
BM2-6-DS-R407C	4503520	198.00
BM2-6-M-R22-R134a	9884897	198.00
BM2-6-DS-R22	9884898	198.00

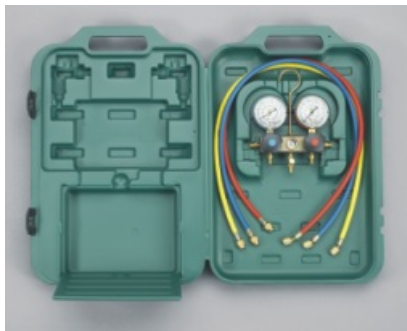

BM2-3-DS

BM2-3

with bourdon type gauges, hook, 3 charging lines 1/4" SAE blue, red, and yellow, length 36 inches (90 cm), in a sturdy plastic case

BM2-3

配有布顿式仪表，挂钩，三条编号充气线接头1/4英寸SAE，蓝色、红色及黄色，长度36英寸（90厘米），包装于坚固的塑料箱中。

	Part No
BM2-3-DS-R12-N	9882138
BM2-3-M-R134a	9883767
BM2-3-DS-R134a	9882140
BM2-3-DS-R407C	4503546
BM2-3-M-R22	9884899
BM2-3-DS-R22	9884900

	部件号	237.00
BM2-3-DS-R12-N	9882138	237.00
BM2-3-M-R134a	9883767	237.00
BM2-3-DS-R134a	9882140	237.00
BM2-3-DS-R407C	4503546	237.00
BM2-3-M-R22	9884899	237.00
BM2-3-DS-R22	9884900	237.00

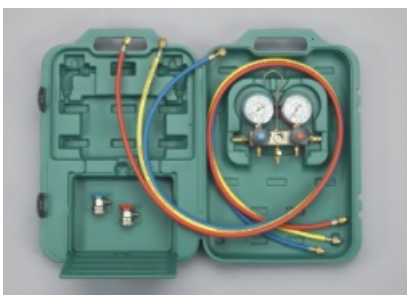

BM2-3-Auto-Set

BM2-3-Auto-Set

consisting of:
 1 pc BM2-8-R134a
 1 pc CL-72-B
 1 pc CL-72-R
 1 pc CL-72-Y
 1 pc CX-Auto-B-1/4" SAE
 1 pc CX-Auto-R-1/4" SAE
 1 pc M4-6-15

manifold
 blue charging line
 red charging line
 yellow charging line
 low pressure valve blue
 high pressure valve red
 plastic case

BM2-3-Auto-Set

包括：
 1件 BM2-8-R-134a
 1件 CL-72-B
 1件 CL-72-R
 1件 CL-72-Y
 1件 CX-Auto-B-1/4" SAE
 1件 CX-Auto-R-1/4" SAE
 1件 M4-6-15

复式接头
 蓝色充气线
 红色充气线
 黄色充气线
 低压阀
 高压阀
 塑料箱

	Part No
BM2-3-Auto-Set-DS	9883395

	部件号	406.00
BM2-3-Auto-Set-DS	9883395	406.00

Two-way manifolds

双向复式接头



M2-6-DS

Two-way manifold with bellow type gauge

This series of manifolds is equipped with sight glass and bellow type gauges class 1. The oilfilled gauges are made of anodized aluminium, standard bellow type gauges are made of plastic.

M2-8
with standard bellow type gauges, hook, without accessories, packed in a cardboard box

	Part No
M2-8-DS-R12	9882555
M2-8-M-R134a	9883649
M2-8-DS-R134a	9883768
M2-8-M-R22	9884998
M2-8-DS-R22	9884391

M2-6
with standard bellow type gauges, hook, 3 charging lines 1/4" SAE blue, red and yellow, length 36 inches (90 cm), packed in a cardboard box

	Part No
M2-6-DS-R12	9883769
M2-6-M-R134a	9883770
M2-6-DS-R134a	9883771
M2-6-M-R22	9884999
M2-6-DS-R22	9884390
M2-6-M-R407C	9884245

M2-3
with standard bellow type gauges, hook, 3 charging lines 1/4" SAE blue, red and yellow, length 36 inches (90 cm), in a sturdy plastic case

	Part No
M2-3-M-R12	9885035
M2-3-DS-R12	9882564
M2-3-M-R134a	9883550
M2-3-DS-R134a	9883354
M2-3-M-R22	4493754
M2-3-DS-R22	9884355
M2-3-M-R407C	9883986

M2-3-DELUXE
with oilfilled bellow type gauges, hook, 3 charging lines 1/4" SAE blue, red and yellow, length 36 inches (90 cm), in a sturdy plastic case

	Part No
M2-3-DELUXE-M-R12	9885034
M2-3-DELUXE-DS-R12	9882552
M2-3-DELUXE-M-R134a	9883511
M2-3-DELUXE-DS-R134a	9883722
M2-3-DELUXE-M-R22	9884977
M2-3-DELUXE-DS-R22	9884392
M2-3-DELUXE-M-R407C	9883368



M2-3-DELUXE

双向复式接头配有波纹管式计量表

本系列复式接头配备透视玻璃和波纹管式1级计量表。注油计量表为经阳极化处理的铝制品，标准波纹管式计量表为塑料制品。

M2-8
配有标准波纹管式计量表，挂钩，无附件，包装于纸箱中。

	部件号	CHF
M2-8-DS-R12	9882555	250.00
M2-8-M-R134a	9883649	250.00
M2-8-DS-R134a	9883768	250.00
M2-8-M-R22	9884998	250.00
M2-8-DS-R22	9884391	250.00

M2-6
配有布顿式仪表，挂钩，三条编号充气线接头1/4英寸SAE，蓝色、红色及黄色，长度36英寸（90厘米），包装于纸箱中。

	部件号	CHF
M2-6-DS-R12	9883769	298.00
M2-6-M-R134a	9883770	298.00
M2-6-DS-R134a	9883771	298.00
M2-6-M-R22	9884999	298.00
M2-6-DS-R22	9884390	298.00
M2-6-M-R407C	9884245	298.00

M2-3
配有标准波纹管式仪表，挂钩，三条编号充气线接头1/4英寸SAE，蓝色、红色及黄色，长度36英寸（90厘米），包装于坚固的塑料箱中。

	部件号	CHF
M2-3-M-R12	9885035	332.00
M2-3-DS-R12	9882564	332.00
M2-3-M-R134a	9883550	332.00
M2-3-DS-R134a	9883354	332.00
M2-3-M-R22	4493754	332.00
M2-3-DS-R22	9884355	332.00
M2-3-M-R407C	9883986	332.00

M2-3-DELUXE
配有注油波纹管式仪表，挂钩，三条编号充气线接头1/4英寸SAE，蓝色、红色及黄色，长度36英寸（90厘米），包装于坚固的塑料箱中。

	部件号	CHF
M2-3-DELUXE-M-R12	9885034	463.00
M2-3-DELUXE-DS-R12	9882552	463.00
M2-3-DELUXE-M-R134a	9883511	463.00
M2-3-DELUXE-DS-R134a	9883722	463.00
M2-3-DELUXE-M-R22	9884977	463.00
M2-3-DELUXE-DS-R22	9884392	463.00
M2-3-DELUXE-M-R407C	9883368	463.00

Two-way manifolds
双向复式接头

JUMBO-STAR
JUMBO-STAR

Two way manifolds
compact brass body
with sight glass

With large 3/8" bores and
3/8" connections

JUMBO-STAR-2-6

With bourdon type gauges, hook,
3 charging lines 3/8" SAE blue, red and
yellow, length 36 inches (90 cm),
packed in a cardboard box.

JUMBO-STAR-2-6-DS-R12-N	4493851
JUMBO-STAR-2-6-DS-R134a	4493860
JUMBO-STAR-2-6-M-R134a	4493878

JUMBO-STAR

双向复式接头
高密度铜件
配备透视镜

大号3/8英寸内径及3/8英寸接头

JUMBO-STAR-2-6

配备布顿型计量表，挂钩、三条充气线
3/8英寸SAE蓝色、红色和黄色，长度
36英寸（90厘米），包装于纸板箱中。

	Part No	部件号	
JUMBO-STAR-2-6-DS-R12-N	4493851	4493851	289.00
JUMBO-STAR-2-6-DS-R134a	4493860	4493860	289.00
JUMBO-STAR-2-6-M-R134a	4493878	4493878	289.00

CHF
Two-way manifold SUPER-LUXE

The master piece in design and
technology:

- body made of high quality eloxed
aluminium
- bellow type gauges class 1.0

MK-2-3 SUPER LUXE

with oil filled bellow type gauges, hook,
3 charging lines 1/4" SAE, blue, red and
yellow, length 60 inches (150 cm), in a
sturdy plastic case

MK-2-3-DS-R12	9883536
MK-2-3-M-R134a	9885045
MK-2-3-DS-R134a	9882592
MK-2-3-M-R407C	9882589

双向复式接头SUPER-LUXE

杰出的设计和技术:

- 高质量铝制品
- 波纹管式计量表1.0级

MK-2-3 SUPER LUXE

配有注油波纹管式仪表，挂钩，三条编号充
气线接头1/4英寸SAE，蓝色、红色及黄色，
长度60英寸（150厘米），包装于坚固的塑
料箱中。

	Part No	部件号	
MK-2-3-DS-R12	9883536	9883536	485.00
MK-2-3-M-R134a	9885045	9885045	485.00
MK-2-3-DS-R134a	9882592	9882592	485.00
MK-2-3-M-R407C	9882589	9882589	485.00

MK-S-3-SUPER LUXE

Four-way manifolds

四向复式接头



BM4-8-DS

Four-way manifold with Bourdon type gauges and sight glass

BM4-8

with bourdon type gauges, hook, without accessories, packed in a cardboard box

	Part No
BM4-8-DS-R12-N	9883798
BM4-8-M-R134a	9883799
BM4-8-DS-R134a	9883800
BM4-8-DS-R407C	4503598
BM4-8-M-R22-R134a	9884911
BM4-8-DS-R22	9884912

四向复式接头，布顿式计量表及透视玻璃。

BM4-8

四向复式接头及布顿式计量表，挂钩，无附件，包装于纸箱中。

	部件号	CHF
BM4-8-DS-R12-N	9883798	268.00
BM4-8-M-R134a	9883799	268.00
BM4-8-DS-R134a	9883800	268.00
BM4-8-DS-R407C	4503598	268.00
BM4-8-M-R22-R134a	9884911	268.00
BM4-8-DS-R22	9884912	268.00



BM4-6-DS

BM4-6

with bourdon type gauges, hook, 3 charging lines 1/4" SAE, blue, red and yellow, length 36 inches (90 cm), packed in a cardboard box

	Part No
BM4-6-DS-R12-N	9883802
BM4-6-M-R134a	9883803
BM4-6-DS-R134a	9883804
BM4-6-DS-R407C	4503422
BM4-6-M-R22-R134a	9884913
BM4-6-DS-R22	9884914

BM4-6

配有布顿式仪表，挂钩，三条编号充气线接头1/4英寸SAE，蓝色、红色及黄色，长度36英寸（90厘米），包装于纸箱中。

	部件号	CHF
BM4-6-DS-R12-N	9883802	314.00
BM4-6-M-R134a	9883803	314.00
BM4-6-DS-R134a	9883804	314.00
BM4-6-DS-R407C	4503422	314.00
BM4-6-M-R22-R134a	9884913	314.00
BM4-6-DS-R22	9884914	314.00

BM4-3

with bourdon type gauges, hook, 3 charging lines 1/4" SAE blue, red and yellow, length 36 inches (90 cm), in a sturdy plastic case

	Part No
BM4-3-DS-R12-N	9883806
BM4-3-M-R134a	9883807
BM4-3-DS-R134a	9883808
BM4-3-DS-R407C	4503414
BM4-3-M-R22-R134a	9884915
BM4-3-DS-R22	9884916

BM4-3

配有布顿式仪表，挂钩，三条编号充气线接头1/4英寸SAE，蓝色、红色及黄色，长度36英寸（90厘米），包装于坚固的塑料箱中。

	部件号	CHF
BM4-3-DS-R12-N	9883806	351.00
BM4-3-M-R134a	9883807	351.00
BM4-3-DS-R134a	9883808	351.00
BM4-3-DS-R407C	4503414	351.00
BM4-3-M-R22-R134a	9884915	351.00
BM4-3-DS-R22	9884916	351.00



M2-6-09

Spare parts for 1- and 2-way manifolds

M2-6-09-B
knob blue
Part No 4490950

M2-6-09-R
knob red
Part No 4490968



M2-7-SET

M2-7-SET-B
handwheel blue
Part No 4677834

M2-7-SET-R
handwheel red
Part No 4677826



M4-6-09

Spare parts for 2-, 3- and 4-way manifolds

M4-6-09-B
knob blue
Part No 4490976

M4-6-09-R
knob red
Part No 4490992

M4-6-09-N
knob black
Part No 4490984

M4-6-09-Y
knob yellow
Part No 4491000

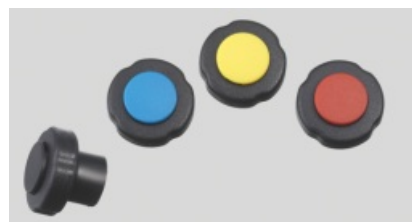

M4-7-SET

M4-7-SET-B
knob blue
Part No 4677850

M4-7-SET-R
knob red
Part No 4677842

M4-7-SET-N
knob black
Part No 4677868

M4-7-SET-N
knob black
Part No 4677876

单向和双向复式接头备件

M2-6-09-B
蓝色旋钮
部件号 4490950

M2-6-09-R
红色旋钮
部件号 4490968

M2-7-SET-B
红色旋钮
部件号 4677834

M2-7-SET-R
红色旋钮
部件号 4677826

双向、三向和四向复式接头

M4-6-09-B
蓝色旋钮
部件号 4490976

M4-6-09-R
红色旋钮
部件号 4490992

M4-6-09-N
黑色旋钮
部件号 4490984

M4-6-09-Y
黄色旋钮
部件号 4491000

M4-7-SET-B
蓝色旋钮
部件号 4677850

M4-7-SET-R
红色旋钮
部件号 4677842

M4-7-SET-N
黑色旋钮
部件号 4677868

M4-7-SET-N
黑色旋钮
部件号 4677876

CHF

8.40

8.40

8.30

8.30

4.25

4.25

4.25

4.25

6.80

6.80

6.80

6.80

Spare parts for manifolds

复式接头备件



M2-10-95

Spare parts for all manifolds

所有复式接头备件

CHF

M2-10-95/10
complete valve set
Part No 9884818

M2-10-95/10
全套阀门组
部件号 9884818

122.00



M4-6-04

M4-6-04/10
piston including gaskets
Part No 9884161

M4-6-04/10
活塞及垫圈
部件号 9884161

53.50



M4-6-11

M4-6-11
Assembly of sight glass, gaskets and threaded
brass ring
Part No 4491018

M4-6-11
包括适视玻璃，胶圈及螺丝铜环
部件号 4491018

17.10



M4-6-11-T

M4-6-11-T
key for manifold
sight glass
Part No 4493169

M4-6-11-T
复式接头销匙
透视镜
部件号 4493169

35.00



M4-6-14

M4-6-14
plastic case
with rubber foam inset
Part No 4678431

M4-6-14
塑料箱
内有橡皮泡沫
部件号 4678431

50.50



M4-6-15

M4-6-15
plastic case to fit the various
2-way and 4-way REFCO manifolds
Part No 4666106

M4-6-15
多用途胶盒，
可用于双向及四通表组
部件号 4666106

53.00

**REFCO-Hoses 1/4" SAE**

REFCO-hoses are supplied with teflon gaskets.

The lifetime of teflon-gasket compared to ordinary rubber is at least 10 times longer.

The barb of the hose, as well as the teflon-gasket have been equipped with a new invented quick-snapper system to prevent falling out of the hose.

High Quality lines suitable for all Refrigerants, working pressure 60 bar/ 870 psi, set of 3 lines 1 unit each blue, red and yellow

REFCO-软管 1/4 英寸SAE

[威科]软管与特氟隆垫圈一同提供。与普通橡胶相比特氟隆垫圈的使用寿命至少长10倍以上。软管的倒钩和特氟隆垫圈装置有新发明的快速嵌入器系统可防止掉出软管。

高质量线，适用于所有制冷剂，工作压力为60巴/870每平方英寸，每套3条，蓝色、红色和黄色。

Set of 3 pieces

每套三条

Designation 名称	Length 长度	长度	Part No 部件号
CCL-36	36 inches/英寸	90cm/厘米	9881278
CCL-48	48 inches/英寸	120cm/厘米	9881277
CCL-60	60 inches/英寸	150cm/厘米	9881276
CCL-72	72 inches/英寸	180cm/厘米	9881275

CHF

58.00
70.50
81.50
94.00



CCL-36

Single Charging Lines 单条充气线

Designation 名称	Length 长度	长度	Part No 部件号			
			B	R	Y	
CL-6	6 inches/英寸	15cm/厘米	9881256	9881265	9881274	15.40
CL-12	12 inches/英寸	30cm/厘米	9881255	9881264	9881273	16.60
CL-24	24 inches/英寸	60cm/厘米	9881254	9881263	9881272	18.00
CL-36	36 inches/英寸	90cm/厘米	9881253	9881262	9881271	19.40
CL-48	48 inches/英寸	120cm/厘米	9881252	9881261	9881270	23.20
CL-60	60 inches/英寸	150cm/厘米	9881251	9881260	9881269	27.10
CL-72	72 inches/英寸	180cm/厘米	9881250	9881259	9881268	31.50
CL-120	120 inches/英寸	300cm/厘米	9881249	9881258	9881267	47.50
CL-144	144 inches/英寸	365cm/厘米	9881247	9881257	9881266	55.50

4

15.40
16.60
18.00
19.40
23.20
27.10
31.50
47.50
55.50



HCL6-36

Heavy-Duty-Lines 3/8" SAE**高强度线3/8英寸SAE**

Large Diameter Heavy Duty Lines

大直径高强度线

Recommended as permanent part for all refrigerants.

建议作为所有制冷剂的永久性部件

Hose 3/8", connection with O-Ring

软管3/8英寸，以O形环连接

Designation 名称	Length 长度	长度	Part No 部件号			
			B	R	Y	
HCL6-36	36 inches/英寸	90 cm/厘米	9881310	9881320	9881315	38.00
HCL6-48	48 inches/英寸	120 cm/厘米	9881309	9881319	9881314	42.00
HCL6-60	60 inches/英寸	150 cm/厘米	9881308	9881318	9881313	46.00
HCL6-72	72 inches/英寸	180 cm/厘米	9881307	9881317	9881312	49.50
HCL6-144	144 inches/英寸	365 cm/厘米	9881306	9881316	9881311	73.00

When ordering specify colour requested:
B=Blue, R=Red, Y=Yellow

订货时请说明所需颜色:
B为蓝色, R为红色, Y为黄色

Spare Parts for Charging Lines

充气线备件



P-510

P-510/10
O-Ring Gasket for 3/8" SAE charging lines
Part No 9880870



A-40513

A-40513/10
Depressor for 3/8" heavy duty lines
Part No 9884813

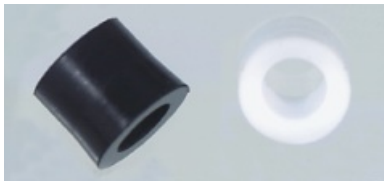

P-509

P-509-T

P-509/100
as above, 100 pieces
Part No 9883980

P-509-T/10
Teflon gasket, 10 pieces white,
for all REFCO charging hoses
Part No 9880871

P-509-T/100
as above, 100 pieces
Part No 9883979



P-513

P-513/10
Depressor for Schrader-valves,
10 pieces
Part No 9880869

P-513/100
as above, 100 pieces
Part No 9883961

Spare Parts, Connections

备件, 接头



CPV-250-E-1/4" SAE



CPV-250-S-1/4" SAE

CPV-250-E-1/4" SAE
Elbow connector for magic line with built-in
valve
Part No 9881226

CPV-250-S-1/4" SAE
Straight connector for magic line with
built-in valve
Part No 9881225



CL-ECD-1/4" SAE



CL-SC-1/4" SAE

CL-SC-1/4" SAE
Straight connector for normal 1/4" SAE
charging line consists of nut, barb and gasket
Part No 9881224

CL-ECD-1/4" SAE
Elbow connector for normal 1/4" SAE
charging line consists of nut, barb,
depressor and gasket
Part No 9881223

V-35010/5
Straight Coupler
Part No 9884825

V-35012/5
Elbow Coupler
Part No 9884826

V-35410/5
Straight Coupler for R410A
Part No 4666336

V-35412/5
Elbow Coupler for R410A
Part No 4666344



V-35012

V-35010

P-510/10
O-型环垫圈用于3/8英寸SAE充气线
部件号 9880870

A-40513/10
压缩器用于3/8英寸强度线
部件号 9884813

P-509/100
同上, 100枚
部件号 9883980

P-509-T/10
特氟隆垫圈, 白色, 10枚,
用于1/4英寸SAE软管
部件号 9880871

P-509-T/100
同上, 100枚
部件号 9883979

P-513/10
施瑞德阀压缩器,
10枚
部件号 9880869

P-513/100
同上, 100枚
部件号 9883961

CPV-250-E-1/4" SAE
魔术线弯接头及内置阀门
部件号 9881226

CPV-250-S-1/4" SAE
魔术线直接头及内阀门
部件号 9881225

CL-SC-1/4" SAE
用于普通1/4英寸SAE充气
线的直接头, 包括螺母、倒钩及垫圈
部件号 9881224

CL-ECD-1/4" SAE
用于普通1/4英寸SAE充气
线的弯接头, 包括螺母、
倒钩、缓冲器及垫圈
部件号 9881223

V-35010/5
直耦合器
部件号 9884825

V-35012/5
弯耦合器
部件号 9884826

V-35410/5
直形接头用于R410A
部件号 4666336

V-35412/5
角形接头用于R410A
部件号 4666344

CHF
14.50

31.50

6.10

53.00

11.00

103.00

14.50

122.00

26.90

26.50

5.60

6.20

237.00

264.00

298.00

335.00



CA-2-R

CA-2-B
Valve without accessories, blue,
I.D. 1/8" both sides
Part No 4492804

CA-2-R
Valve without accessories, red,
I.D. 1/8" both sides
Part No 4492791

CA-2-Y
Valve without accessories, yellow
I.D. 1/8" both sides
Part No 4492812

CA-2-B
无附件阀，蓝色
两端内径均为1/8英寸
部件号 **4492804**

CA-2-R
无附件阀，红色
两端内径均为1/8英寸
部件号 **4492791**

CA-2-Y
无附件阀，黄色
两端内径均为1/8英寸
部件号 **4492812**

CA-1/4" SAE-B
Valve in connection with charging hoses,
O.D. 1/4" SAE, I.D. 1/4" SAE with loose nut
and core depressor, blue
Part No 4493525

CA-1/4" SAE-R
Valve in connection with charging hoses,
O.D. 1/4" SAE, I.D. 1/4" SAE with loose nut
and core depressor, red
Part No 4493533

CA-1/4" SAE-Y
Valve in connection with charging hoses,
O.D. 1/4" SAE, I.D. 1/4" SAE with loose nut
and core depressor, yellow
Part No 4493738

CA-1/4" SAE-B
与充气软管连接的阀，外径为1/4英寸
SAE，内径为1/4英寸SAE，配备可松
动螺母和核心压器，蓝色
部件号 **4493525**

CA-1/4" SAE-R
与充气软管连接的阀，外径为1/4英寸
SAE，内径为1/4英寸SAE，配备可松
动螺母和核心压器，红色
部件号 **4493533**

CA-1/4" SAE-Y
与充气软管连接的阀，外径为1/4英寸
SAE，内径为1/4英寸SAE，配备可松
动螺母和核心压器，黄色
部件号 **4493738**



CA-1/4" SAE-Y

Charging hoses with small ball valve

配有小球阀的充气软管

Set of 3 pieces

每套三条



CA-CCL-36

Designation 名称	Length 长度	长度	Part No 部件号
CA-CCL-36	36 inches/英寸	90cm/厘米	4493614
CA-CCL-60	60 inches/英寸	150cm/厘米	4493622
CA-CCL-72	72 inches/英寸	180cm/厘米	4493631

CHF

15.80

15.80

15.80

24.00

24.00

24.00

Single Line Charging

单条充气线

Designation 名称	Length 长度	长度	Part No 部件号		
			B	R	Y
CA-CL-36	36 inches/英寸	90cm/厘米	4492910	4492928	4492936
CA-CL-60	60 inches/英寸	150cm/厘米	4492944	4492952	4492961
CA-CL-72	72 inches/英寸	180cm/厘米	4492979	4492987	4492995

103.00

123.00

136.00

35.00

42.00

45.00



威科制造商
REFCO Manufacturing Ltd.
Industriestrasse 11
CH-6285 Hitzkirch (Switzerland)

Phone
Fax
info@refco.ch

+41 41 919 72 82
+41 41 919 72 83
www.refco.ch



UV Leak Detectors
Electronic Leak Detectors
Propane Leak Detectors
Leak Search Sprays

紫外线泄漏探测器
电子泄漏探测器
丙烷泄漏探测器
泄漏搜寻喷射器

威科制造商
REFCO Manufacturing Ltd.
Industriestrasse 11
CH-6285 Hitzkirch (Switzerland)

Phone
Fax
info@refco.ch

+41 41 91972 82
+41 41 91972 83
www.refco.ch

Electronic Leak Detectors for all Halogenated Refrigerants

电子泄漏探测器 适用于所有卤化制冷剂



STARTEK



STARTEK



STARTEK



STARTEK-CASE

StarTek

- extremely compact design concept similar to a cell phone
- ergonometical design focused on performance and simplicity of operation
- Microprocessor controlled unit and state of the art microelectronics
- Detects all halogenated refrigerants
- Certified to SAE J1627 standard
- Simple one-button operation
- Two sensitivity levels using a doubleclick computer mouse action
- One touch reset-mode
- High performance true mechanical Pump to provide positive airflow through the sensing tip
- Leak indication using both variable frequency audible and visual alarm
- Automatic shut-off after extended period of non-use to preserve battery life
- Battery life indicator
- Prevents incorrect readings by providing visual and audible warning followed by an automating shut-off when battery reaches a critical level
- State of the art sensor technology for higher reliability and longer life time
- Includes a practical belt clip holster that also protects the unit in your tool box
- Specially designed 12"(30 cm) flexible probe for easy reach
- Additional replacement sensor included inside the battery compartment
- In a sturdy plastic case

Technical Data

Dimensions:	150 x 34 x 55 mm
Weight:	190g
Batteries:	2 x AA batteries
Battery lifetime:	40 hours
Sensitivity:	less than 3g/year (0,1oz/year)
Sensor lifetime:	approx.30 hours
Operating temperature:	0-50°C
Warm-up time:	less than 2 seconds
Response time:	instantaneous
Reset time:	instantaneous
Probe Length:	30cm

Part No 4507569

ES-02

Replacement sensor (Pack of 2)
Part No 4507577

STARTEK-CASE

Carrying case for STARTEK
Part No 4664333

StarTek

- 产品采用蜂巢结构式设计
- 精确度比一般泄漏探测仪准确度极高
- 寻找泄漏目标焦点最接近
- 能用全部冷煤，包括所有环保冷煤等
- 产品标准SAEJ1627 认可
- 按钮开关操作简单
- 按钮式重组键
- 高效能而准确的机械式抽气能提供正确气流至感应器尖端
- 不但能提供渐变式而可听见的频率而且还有视觉上的信号
- 若在长时间不用状态下系统会自动关闭以保护电池寿命
- 电池寿命指示器
- 当电池不够能源时会发出警报讯号几声响，
- 为避免错误数据读出系统会自动关机
- 此人工感应器技术是属于高度可靠性及延长寿命形式
- 内含一个实用皮夹子套来保护工具箱内的检漏仪
- 特别设计12英寸(30公分)探测器能容易
- 地伸展到所需范围
- 附加感应器探测头在电池分隔栏内

技术数据

体积:	150 x 34 x 55mm
重量:	190克
电池:	2 x AA电池
电池使用:	40小时
精准度:	3克/每年 (0.1安士/每年)
感应器:	能用30小时
温度:	0-50度(摄氏)
标准时间:	最小测2次
反应时间:	实时
重复时间:	实时
准确度:	30厘米

部件号 4507569

ES-02

反备感应头(2个包装)
部件号 4507577

STARTEK-CASE

专用于电子泄漏探测仪
部件号 4664333

CHF

618.00

121.00

29.00

Electronic Leak Detectors for all Halogenated Refrigerants

电子泄漏探测器 适用于所有卤化制冷剂



STARTEK-C



STARTEK-C

STARTEK-C

The new combustible Gas Leak Detector in the new successful design is the most technologically advanced of its kind.

The STARTEK-C's low power requirements, small size and high sensitivity combine to create a tool which is easy to handle and ultra effective at locating even the most difficult-to-find leaks.

The STARTEK-C's long life sensor will detect concentrations of combustible gases as low as 5 ppm. It is sensitive to all combustible gases. The STARTEK-C also features a low sensitivity mode, enabling quick and easy location of large combustible gas leaks.

Supplied in a sturdy plastic case.

Technical Data:

Dimensions: 150 x 34 x 55 mm
 Weight: 190 g
 Batteries: 2 x AA batteries
 Battery lifetime: 11 hours
 Sensitivity: less than 50 ppm
 (Propane, Isobutan, Methane)
 Sensor lifetime: less than 1 year normal use
 Operating temperature: 0-50 °C
 Warm-up time: 45 seconds
 (conditioned sensor)
 Calibration: automatic
 Response time: 5 seconds
 Reset time: 5 seconds or more
 depending on gas concentration
 Probe length: 30cm

Part No 4660664

STARTEK-C-CASE

Carrying case for STARTEK-C

Part No 4665593

ES-C

Replacement sensor

Part No 4660672

STARTEK-C

最新敏感型气体检漏仪，低电量要求，轻巧，高敏感度结合工具，易于操作更能有效地感应洩漏来源，此型备有长寿命感应头集中感应可燃气体低至5ppm，内置高效能而准确机械式抽气泵，能提供正确气流至感觉器末端。此检漏仪，可检漏所有可燃气体，能够容易快速地寻找洩漏位置。

新款型号包装在坚固塑料箱内。

技术数据:

体积: 150 x 34 x 55毫米
 重量: 190克
 电池: 2 x AA电池
 电池使用: 11小时
 精确度: 少于50ppm
 (最佳电池)
 感应器: 正常使用下少于1年
 温度: 0-50度 (摄氏)
 准备时间: 45秒
 校对模式: 自动
 反应时间: 5秒
 重设时间: 5秒或以上, 取决于气体集中情况
 探索器度: 30厘米

部件号 4660664

STARTEK-C-CASE

便携式塑料箱

部件号 4665593

ES-C

探索头

部件号 4660672

CHF

656.00

29.00

133.00

Ultra Violet Leak Detector

紫外线泄漏探测器



UV-12-KIT

The uncompromised way of leak detection with the compact and powerful UV-12 ultraviolet inspection lamp. The UV-12 can either be connected directly on a vehicle battery or being powered by the optional go anywhere battery pack. This makes the UV-12 the universal UV detector in the automotive field as well as for all other refrigeration and air con applications.

UV-12 enables to find leaks where electronic leak detectors could be compromised, like extremely small leaks, intermittent leaks, multiple leaks. Even leaks where all the gas has already escaped can still be found as the UV-12 will still show the fluorescent trace.

One shot of fluorescent applied into a system with the practical injector gun is sufficient for 1.5 kg of refrigerant and up to 300 grams of compressor oil.

使用密集强力UV-12紫外线探照灯进行无懈可击的泄漏探测。UV-12既可以直接连接于车辆电池，亦可由任何随意携带的电池盒供电。这使得UV-12在汽车领域和一切其他冷冻和空调电器的应用中成为普及的UV探测器。

UV-12可发现电子探测器所无能为力的泄漏，如特小的泄漏，间断性泄漏和多发性泄漏等。甚至是气体已泄漏殆尽的泄漏仍可测出，因为UV-12仍可显示荧光痕迹。

用注射枪对系统进行一次荧光注射便足够用于1.5公斤制次冷剂和300克压缩机油。



UVA-10

UV-12-KIT

Kit complete in sturdy plastic case
Content:
UV-Inspection lamp 12 volt/100W
Crocodile clip adapter for battery connection
Glo-Gun injector system
Glo-Gun refill cartridge
Safety spectacles
Hose assembly with automotive coupling
Hose assembly with 1/4" SAE connection
Part No 9884406

UV-12-KIT

全套工具包装于坚固的塑料箱内，内有：
UV-探照灯12伏特/100瓦
供电使用的鳄鱼夹调节器
Glo-Gun注射系统
Glo-Gun再次充装盒
安全眼镜
带有自动耦合的软管
带有 1/4 英寸SAE接头的软管

部件号 9884406

CHF



UV-100-02

UV-GLO-LEAK-C

Glo-Leak refill cartridge, content 48 ml
Part No 9884405

UV-GLO-LEAK-C

Glo-Leak 再次充装盒，容量48 毫升
部件号 9884405



UV-12-GLO-LEAK-250 UV-GLO-LEAK-C

UV-GLO-LEAK-250

Fluorescent liquid, content 250 ml
Part No 9884515

UV-GLO-LEAK-250

荧光液，容量250 毫升
部件号 9884515

UV-AKKU

Battery pack 12 volt including charger 220 V
Part No 9884514

UV-AKKU

12 伏特电池盒，包括220 伏特充电器
部件号 9884514

UV-DYE-CLEAN

Dye Cleaner 500 ml
Part No 9884932

UV-DYE-CLEAN

染料清洁剂500 毫升
部件号 9884932



UVA-13

UVA-13

The new portable UV-inspection lamp (12 V / 55 W) with its own internal rechargeable battery. Lamp includes mains charger as well as connection plug for in-car charging.
Part No 4503651

UVA-13

新的可携带UV-探测灯（12V/55W），内置充电式电池，探测灯泡包括主充电器

部件号 4503651

909.00

81.50

196.00

420.00

25.00

485.00

Propane Leak Detector
丙烷泄漏探测器

16840



16847

16840

Halide leak detector locates non-combustible refrigerant gas leaks (R12, R22, R502) quickly and accurately. Leaks cause visible change of colour and intensity of flame housed in burner. Portable, lightweight, complete with solid brass leak detector assembly, search hose and fuel cylinder which lasts up to 15 hours.

Part No 9881459

16840-01

Halide leak detector without tank, including hose

Part No 9881458

16840-12

Orifice for 16840

Part No 9882121

16847

Propane one-way cartridge

Part No 9881693

16848

Reactor plate

Part No 9881691



16848

Leak Search-Spray
10620

Leak shooter search-spray contents 375 g

A real hit for any service man to shoot for leaks on pressurised tubes i.e. systems. Easy application; just spray strongly any pressurised lines with Leaky-Shooter. Bubbles will occur immediately on leaky systems.

No danger!

Part No 9881420



10620

10621

Yellow-search leak detection oil sticks to surface and secures leak finding for extremely small leakages by producing bubbles. Size 8 fl. oz (237 ml)

Part No 9881419



10621

10622

The trace-finder can be added to all refrigerants and refrigeration systems. Trace will make the refrigerant intense red and therefore leaks become immediately visible. The application does not affect the system in any way. Size 4 fl. oz (118 ml) 1/8 oz needed per/lb

Part No 9881453



10622

16840

卤化物泄漏探测器可快速准确地测定非可燃性制冷剂的气体泄漏 (R12, R22和R502)。泄漏可造成燃烧器内肉眼可见的颜色变化和火焰强度变化。

轻便、可携带并配有坚固的铜制泄漏探测器装配零件、探寻软管和可持续15小时的燃油罐。

部件号 9881459

16840-01

无罐卤化物泄漏探测器, 包括软管

部件号 9881458

16840-12

16840通气口

部件号 9882121

16847

丙烷单向气筒

部件号 9881693

16848

反应器底盘

部件号 9881691

丙烷泄漏探测器
10620

检漏引射器
容量375克

检漏引射器是维修人员用来检验耐压管或系统中是否有泄漏。使用很方便, 只需用引射器将液体射向耐压系统, 有泄漏的位置立即会出现泡沫。

无危险

部件号 9881420

10621

黄色检漏油贴, 将油涂于表面。如有细微泄漏即会产生泡沫。
容量237毫升

部件号 9881419

10622

检漏试剂, 将检漏试剂加入制冷系统。试剂将制冷呈红色, 且一泄漏会立即被发现。试剂对制冷系统的运行无任何影响。

容量118毫升

每磅需要1/8盎司

部件号 9881453

CHF

133.00

110.00

5.20

22.40

11.00

16.80

16.40

22.30



威科制造商
REFCO Manufacturing Ltd.
Industriestrasse 11
CH-6285 Hitzkirch (Switzerland)

Phone
Fax
info@refco.ch

+41 41 919 72 82
+41 41 919 72 83
www.refco.ch



Thermometers
Control Instruments
Thermostats, Timers

温度计
控制仪器
恒温计时器

威科制造商
REFCO Manufacturing Ltd.
Industriestrasse 11
CH-6285 Hitzkirch (Switzerland)

Phone
Fax
info@refco.ch

+41 41 91972 82
+41 41 91972 83
www.refco.ch

Thermometers with capillary tube
毛细管温度计

F-87-R-60

Universal design which can be mounted from the back or from the front. Elegant plastic construction at very competitive price.

Available in three different diameters: 60, 80 or 100 mm.

普及型设计，可由背面或正面安装。典雅的塑料结构，价格廉宜。

三种不同直径可供选购：
60，80及100毫米。

Thermometer with mounting flange
Range: -40 up to +40°C

温度计及安装法兰：
范围：-40至+40摄氏度

Designation 名称	Length of capillary tube 毛细管长度	Ø 直径	Part No 部件号	
F-87-R-60-1.5	1.5 M/米	60 mm/毫米	9881046	45.00
F-87-R-60-3.0	3.0 M/米	60 mm/毫米	9881045	56.00
F-87-R-80-1.5	1.5 M/米	80 mm/毫米	9881044	48.00
F-87-R-80-3.0	3.0 M/米	80 mm/毫米	9881043	58.50
F-87-R-100-1.5	1.5 M/米	100 mm/毫米	9881042	53.00
F-87-R-100-3.0	3.0 M/米	100 mm/毫米	9881041	63.00
F-87-R-100-4.5	4.5 M/米	100 mm/毫米	9881040	73.50
F-87-R-100-7.5	7.5 M/米	100 mm/毫米	9881039	96.00

Range: -50 up to +50°C

范围：-50至+50摄氏度

Designation 名称	Length of capillary tube 毛细管长度	Ø 直径	Part No 部件号	
F-87-R-100-3.0/50	3.0M/米	100mm/毫米	4492715	68.50

CPF-83
CPF-83

Thermometer Ø 52 mm to be built-in metal sheet housing (cabinets); inside diameter for mounting Ø 51 mm. Length of capillary tube: 1.5 meter. Range: -40 up to +40°C.

Part No 9881035

CPF-83

直径52毫米温度计，内置于金属片外壳中，安装内直径51毫米。

毛细管长度：1.5米。

范围：-40至+40摄氏度

部件号 9881035

CHF
45.00
56.00
48.00
58.50
53.00
63.00
73.50
96.00
68.50
25.90



ROF-88-TS

Thermometer with probe and LED display. For easy reading.

For panel mounting and fixing with elastic clips.

Technical Data:

Temperature range: -50°C up to +99°C
Voltage: 12 Volt
Probe: PTC D6
Built-in dimension: 57.5 x 24.5 mm
Depth: 52 mm
Front flange: 62 x 29 mm

装有探针和LED显示的温度计。便于读取。

用于控制安装以及用弹性夹固定。

技术数据:

温度范围: -50至+99摄氏度
伏特: 12伏
探针: PTC D6
内置直径: 57.5 x 24.5毫米
深度: 52毫米
正面法兰: 62 x 29毫米

ROF-88-TS

Thermometer with thermostat, probe and transformer.

Part No 9881009

ROF-88-TS

温度计及恒温器、探测器和变压器

部件号 **9881009**

CHF

147.00



15165

15165

Rectangular distance-thermometer to be built into cabinets with capillary tube and sensing lead.

Measures on distance gases, liquids, etc. with short reaction time.

Technical Data:

Temperature range: -40°C up to +40°C
Scale dimension: 15 x 30 mm
Built-in dimension: 26 x 58 mm
Length of capillary tube: 1.5 m
Adjustable.

Part No 9881038

15165

长方形远距离温度计，可安装于箱柜内，配备毛细管和感应头。

测量远距离气体、液体等，反应迅速。

技术数据:

温度范围: -40至+40摄氏度
表盘直径: 15 x 30毫米
安装尺寸: 26 x 58毫米
毛细管长度: 1.5米
可调节

部件号 **9881038**

36.00



15166

15166

Digital distance thermometer, rectangular

Technical Data:

Temperature range: -50°C up to +69°C
Built-in dimension: 26 x 45 mm
Length of capillary tube: 3.0m

Part No 9884934

15166

数字型温度计，长方形

技术数据:

温度范围: -5至+69摄氏度
安装尺寸: 26 x 45毫米
毛细管长度: 3.0米

部件号 **9884934**

41.50

Thermometer**15519/10**

Thermometer with hook made from extruded plastic
Scale: -40/+40°C, Ø65 mm

Part No 4503643

温度计**15519/10**

温度计配备挂钩，挤压塑料制造
温度计表盘: -40/+40摄氏度，直径65毫米

部件号 **4503643**

64.50



15519



15140

15140

Digital Stick-Thermometer
Range: -50 up to +150°C

Stick sensor made from stainless steel with protection tube and clips; battery operated

Part No 9881048

15140

数字棒式温度计

温度范围: -50至+150摄氏度
棒式感应器以不锈钢制造，配备护管和夹；电池操作

部件号 **9881048**

55.00

Digital Pocket Thermometer

数字型袋装温度计



DT-150

DT-150
 Range: -40°C to 150°C
 -40°F to 300°F
 Resolution: 0.1°C or $^{\circ}\text{F}$
 Accuracy: $\pm 2^{\circ}\text{F}$ or $\pm 1^{\circ}\text{C}$
 The thermometer is equipped with F/C switch, data hold, protective cover and pocket clip.
Part No 9884365

DT-150
 温度范围: -40 摄氏度至 $+150$ 摄氏度
 -40 华氏度至 $+300$ 华氏度
 分辨能力: 0.1 摄氏度或华氏度
 精确度: ± 2 华氏度或 ± 1 摄氏度
 温度计配备华氏/摄氏转换器、数据留存、保护套及口袋夹

部件号 **9884365**

CHF

54.00

Infrared Thermometer

红色线温度计探测器



LP-79

LP-79
 The LP-79 is a hand-held battery-operated thermometer which measure the temperature by using infrared technology. This technology enables temperature reading from a distance, without having to be in direct physical contact with the surface to be measured. This makes temperature reading very efficient and accurate. The LP-79 is also equipped with a laser pointer to show the measuring target with a red point.
 Temperature Range: -55°C to $+125^{\circ}\text{C}$
 $(-67^{\circ}\text{F}$ to $+260^{\circ}\text{F})$
 Operating Temperature: $+10^{\circ}\text{C}$ to $+52^{\circ}\text{C}$
 $(+50^{\circ}\text{F}$ to $+125^{\circ}\text{F})$
 Resolution: $\pm 2\%$ of reading or 2°C
 (3°F) plus on digit, whichever is greater
 Accuracy:
 Target Size/Field of View: 10:1 with a 2,5cm (1") minimum target

LP-79
 此产品是手提轻巧式, 电池操作红外线使用快速无接触红外线感应器无须直接接触物体表面, 温度探测仪可以从一段距离中量度温度此技术方便, 有效率, 省时及准确配备雷射红色显示点, 能清晰显示目标位置

温度范围: -55 至 $+125$ 摄氏度
 $(-67$ 至 $+260$ 华氏度)
 操作温度: $+10$ 至 $+52$ 摄氏度
 $(+50$ 至 $+125$ 华氏度)
 分辨能力: 1摄氏度或华氏度
 精确度: $\pm 2\%$ 读数
 2摄氏度或3华氏度
 目标大小: 10:1
 视野比率: 相当于2.5厘米/
 1英寸最小目标

部件号 **4505922**

部件号 **4505922**

493.00

Digital thermometer

数字式温度计



HALT-08

HALT-08
 Small and handy multi-test-instrument for humidity, air-speed, light intensity and temperature. A probe for temperature measuring is included.
 Measuring ranges
 Humidity: 10 to 95%
 Air-speed: 0.4 to 30.0 m/s
 (km/h, MPH, knots, ft/min)
 Light intensity: 0 to 20000 LUX
 Temperature: -40°C to $+250^{\circ}\text{C}$ /
 -40°F to $+482^{\circ}\text{F}$
 Battery: 9 Volt
Part No 4661368

HALT-08
 细小及便利的微型测试器主要用于湿度, 风速, 光的明亮和温度。
 量度范围:
 湿度: 10 至 95%
 风速: 0.4 至 30.0米/秒
 光亮度: 0 至 20000 LUX
 温度: -40 摄氏度至 $+250$ 摄氏度
 -40 华氏度至 $+482$ 华氏度
 电池: 9伏
部件号 4661368

577.00



THB-85

THB-85
 Digital thermo-hygrometer for precise measuring of temperature and humidity. With data-hold and min./ max.-mode.
 Measuring range:
 Temperature -40°C to $+85^{\circ}\text{C}$ /
 -40°F to $+185^{\circ}\text{F}$
 Humidity 0 to 100%
 Accuracy:
 Temperature $\pm 0.3^{\circ}\text{C}$ $\pm 0.5^{\circ}\text{F}$
 Humidity $\pm 2\%$
 Reaction time: 10 seconds
 Batteries: 9 Volt / lifetime approx. 160 hours.
Part No 4661376

THB-85
 数字式的温度-湿度计, 准确地量度温度及湿度, 设有数据停留及最低/最高按钮。
 量度范围:
 温度: -40 摄氏度至 $+85$ 摄氏度
 -40 华氏度至 $+185$ 华氏度
 湿度: 0 至 100%
 准确度:
 温度: ± 0.3 摄氏度, ± 0.5 华氏度
 湿度: $\pm 2\%$
 反应时: 10秒
 电池: 9伏/大概维持160小时

部件号 **4661376**

部件号 **4661376**

457.00

Thermostat
恒温器

SP-ST

Thermostat for refrigeration adjustable in the range of -35 up to $+35^{\circ}\text{C}$

SP-ST
15 A 250 V \pm 10 A
Part No 9881005

用于冷冻器的恒温器温度可在 -35 至 $+35$ 摄氏度的范围内调整。

SP-ST
15安250伏 \pm 10安
部件号 9881005

CHF
42.00

TSC-093

TSC-093
240 Vac
15A capacitive
10A inductive
Part No 9884170

TSC-093
240伏
15A容量
10A介入容量
部件号 9884170

45.00

TSC-094

TSC-094
Thermostat for room temperature control,
15A capacitive
10A inductive
Part No 9884937

TSC-094
用于室内温度控制的恒温器，
15A容量
10A介入容量
部件号 9884937

40.00

SL-128
Sound Level Meter
声音量度器

SL-128
This compact Sound Level Meter with digital display and 4 measuring ranges from 30 dB up to 130 dB. Delivered in a sturdy carrying case. The Sound Level can be balanced through two evaluation-filters (A+C). It is possible to define maximum value over a measuring period.

SL-128
复合式声音量度器，配有数字式显示屏4种量度范围由30dB至130dB，包装于坚固的胶盒里，声音水平可以平行的通过两个过滤器（A+C）。量度的这个可以明确限定最高数值，防止量度过度。

Measuring Range: from 30 up to 130 dB
Resolution: 0.1 dB
Frequency: 31.5 Hz up to 8 kHz
Evaluation Filters: Type A- according to human hearing perception
Type C- linear evaluation
Periodic Balance: fast or slow
Accuracy: \pm 1,5 dB
Part No 4661385

量度范围: 由30至130dB
准确度: 0.1dB
频率: 31.5 赫 至 8 千赫
过滤器评估: 种类A
相应人类听觉
种类C直线评估
周期对照: 快或慢
精准度: \pm 1,5dB
部件号 4661385

560.00

LA-40
Air-Meter
风速仪

LA-40
The compact Anemometer with hold-function supplied in a sturdy carrying case.
Range:
0.4-30 m/second or 1.4-108.0 km/hour
80-5910 feet/minute or 0.8-58.3 knots
Part No 4661393

LA-40
复合式测风仪设有暂停功能，包装于坚固胶盒内
范围:
0.4-30米/秒 或 1.4-108.0千米/小时
80-5910英尺/分 或0.8-58.3 knots
部件号 4661393

935.00



威科制造商
REFCO Manufacturing Ltd.
Industriestrasse 11
CH-6285 Hitzkirch (Switzerland)

Phone
Fax
info@refco.ch

+41 41 919 72 82
+41 41 919 72 83
www.refco.ch



Pinch-off-Tools
Tube Cutters
Flaring Tools
Tube Benders
Hand Tools

夹取工具
管切割器
燃烧工具
弯管器
手工工具

威科制造商
REFCO Manufacturing Ltd.
Industriestrasse 11
CH-6285 Hitzkirch (Switzerland)

Phone
Fax
info@refco.ch

+41 41 91972 82
+41 41 91972 83
www.refco.ch

Pinch-Off-Tools

夹取工具



14285

14285
Pinch-Off-Tool
in extra strong execution to pinch-off
suction tubes on all hermetic refrigeration
systems up to 3/8" diameter.
Part No 9881530

14285
夹取工具
夹取任何封闭冷冻系统内直径
达 3/8 英寸的吸管功效特强

部件号 **9881530**

CHF

79.50



14280

14280
Pinch-Off-Plier for production with double
pinch for tubes of \varnothing 3/16" up to 3/8".
Part No 9881529

14280
用于生产的具有双重夹的夹钳可夹
取直径 3/16 英寸至 3/8 英寸管
部件号 **9881529**

780.00

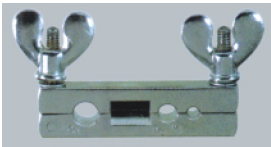

RFA-105-FF

RFA-105-FF
Pinch Off Tool for \varnothing 1/4", 3/8" and 1/2".
Part No 9881528

RFA-105-FF
用于直径 1/4 英寸, 3/8 英寸和 1/2 英寸
的夹取工具
部件号 **9881528**

29.60



14200

14200
Pinch-Off-Plier up to approx. \varnothing 8 mm
Part No 9881527

14200
约达直径8毫米的夹钳
部件号 **9881527**

48.50

Recovery-Service - Piercing Plier

恢复维修钻孔钳



14210

14210
A REFCO top product item which enables
an immediate piercing on the charging
tube at any refrigerator or freezer (Domestic).
Just pierce the tube and you are ready for
evacuating or charging the
system. After finishing the service job
use pinch-off-plier and pinch behind the
Service-Piercing Plier and braze the
tube.

14210
供[威科]顶级生产项目使用, 可
立即钻透任何冰箱或冷库(家用)
的充气管。仅需钻穿管便可进行
系统排气或充气。在完成维修后
使用夹钳在维修钻孔钳背后夹取
然后焊接。

Recovery Service Piercing Plier made
from high quality chrom vanadium
steel with changeable piercing needle
and access fitting.

恢复维修钻孔钳由高质量铬钒钢制
造, 配备可更换钻针和附加配件。

Part No 9881526

部件号 **9881526**

117.00

14210-01/10
Spare Needle \varnothing 6 mm
Part No 4665550

14210-01/10
备用针头 直径6毫米
部件号 **4665550**

76.00

Pinch-Off-Tools

夹取工具



14215

14215
Capillary tube cutter a unique tool to cut all
sizes of any capillary tubes without
swadging the tube.
Part No 9881087

14215
毛细管切割器, 独一无二的切割工具,
可在不摇晃的情况下切割所有尺寸的
毛细管。
部件号 **9881087**

40.50

Tube Cutters
管切割器

14300

14300
Mini-tube cutter 1/8" to 5/8" O.D. with rollers for easy cutting.
Part No 9881634

14300
1/8 英寸至 5/8 英寸外径微型管切割器，配备便于切割的滚轴
部件号 **9881634**

CHF
20.70

14310

14310
Big mini-tube cutter with rollers for easy cutting \varnothing 1/8" to 7/8".
Part No 9881633

14310
直径 1/8 英寸至 7/8 英寸大号微型管切割器，配备便于切割的滚轴
部件号 **9881633**

23.20

14301
Cutting wheel for 14300 and 14310.
Part No 9881628

14301
供14300和14310使用的切割轮
部件号 **9881628**

10.40

RFA-174-F

RFA-174-F
Big-Mini-Cutter
range: \varnothing 3/8" - 1 1/8"
Part No 9881632

RFA-174-F
大号-微型-管
范围：直径 3/8 至 1 1/8 英寸
部件号 **9881632**

37.50

RFA-206-FB
Tube Cutter range: \varnothing 3/8" - 2 3/8"
Part No 9881631

RFA-206-FB
管切割器范围：直径 3/8 至 2 3/8 英寸
部件号 **9881631**

176.00

RFA-274-FC

RFA-274-FC
Tube Cutter \varnothing 1/8" - 1 1/8"
including spare cutting wheel.
Part No 9881630

RFA-274-FC
管切割器直径 1/8 至 1 1/8 英寸
包括备用切割轮
部件号 **9881630**

43.00

RFA-312-FB

RFA-312-FB
Heavy-Duty Cutter \varnothing 1/4" - 1 5/8"
including spare cutting wheel.
Part No 9881629

RFA-312-FB
强力切割器直径 1/4 至 1 5/8 英寸
包括备用切割轮
部件号 **9881629**

52.00

RFA-001
Cutting Wheel from finest HSS high quality steel, hardened for RFA-174-F, RFA-206-FB, RFA-274-FC, RFA-312-FB
Part No 9881624

RFA-001
切割轮由最佳HSS高质钢制造，强化可用于RFA-174-F, RFA-206-FB, RFA-274-FC, RFA-312-FB
部件号 **9881624**

12.60

14338

14338
REFCO-roller is an ideal tool for tubing construction. Handy for making braze- or sweat-type connections. Roller is used in place of cutting wheel.
Part No 9881622

14338
[威科]滚轴是管道建设的理想工具。便于铜焊或熔化式连接。滚轴可代替切割轮使用。

 部件号 **9881622**
58.50

Flaring Tool

开张工具



RF-888-Z

Eccentric Flaring Tool

RF-888-Z

45° Eccentric Flaring Tool in inch sizes.
Made of forged high quality steel for tubes with an outside diameter of: \varnothing 3/16", 1/4", 5/16", 3/8", 1/2", 5/8", 3/4".
The unit is supplied in a sturdy plastic case.
Part No 4506171

RF-888-M

45° Eccentric Flaring tool in metrics sizes.
Made of forged high quality steel for tubes with an outside diameter of: \varnothing 6, 8, 10, 12, 14, 16, 19mm.
The unit is supplied in sturdy plastic case.
Part No 4506180

扩喇叭口（偏心旋转式）工具

RF-888-Z

45度偏心旋转式扩喇叭口英制尺寸用最坚实钢材制造，适用3/16, 1/4, 5/16, 3/8, 1/2, 5/8, 3/4英寸
套装塑料盒设计
部件号 **4506171**

RF-888-M

45度偏心旋转式扩喇叭口英制尺寸坚实钢材制造，适用较坚实喉管外径 6, 8, 10, 12, 14, 16, 19mm
套装塑料盒设计
部件号 **4506180**

CHF

276.00

276.00



525-F

525-F

«Grabber» flaring tool 45° applicable for all tubes in metric and inch sizes from 5 to 16 mm respectively 3/16" to 5/8" O.D.
Part No 9881571

525-F

“Grabbe” 开张工具45度可供任何公制或英寸尺寸的管使用，分别为5至16毫米和 3/16 至 5/8 英寸外径
部件号 **9881571**

126.00



RF-899-Z

RF-899-Z

Ratchet Type Flaring Tool in inch sizes for easy operation if space is tight. Made of forged high quality steel for tubes with outside diameter of: 3/16", 1/4", 5/16", 3/8", 1/2", 5/8", 3/4".
The unit is supplied in a sturdy plastic case.
Part No 4666068

RF-899-Z

棘轮轮形扩喇叭口英制尺寸，容易使用在一些较狭窄的地方用最坚硬材料，适用较坚实喉管3/16, 1/4, 5/16, 3/8, 1/2, 5/8, 3/4, 套装塑胶盒设计
部件号 **4666068**

307.00



TELL -7

TELL -7

Cross-bow-type Tube Bender Set for the following outside diameter: 1/4", 5/16", 3/8", 1/2", 5/8", 3/4", 7/8"
Supplied in a sturdy plastic case.
Part No 4666076

TELL -7

横弓式弯管器可适用于以下外径
外径
1/4, 5/16, 3/8, 1/2, 5/8, 3/4, 7/8英寸
套装塑胶盒设计
部件号 **4666076**

292.00



RF-175-FS

RF-175-FS

45° Flaring and Swaging Tool in inch sizes. Made of forged high quality steel for tubes with an outside diameter of: Ø 1/8", 3/16", 1/4", 5/16", 3/8", 7/16", 1/2", 5/8", 3/4". The unit is supplied in a sturdy plastic case.

Part No 4506198

RF-175-FS

45度式扩喇叭口及扩管器工具用于高质量金属钢锻制造适用于外径喉管: 1/8, 3/16, 1/4, 5/16, 3/8, 7/16, 1/2, 5/8, 3/4英寸 套装塑料盒设计

部件号 4506198

CHF

148.00

Flaring - Swaging Tubing Tools metric and inch

骤燃和型锻工具(公制与英寸)



RF-275-FS/RF-275-FSM

RF-275-FS

45° Flaring and Swaging Tool in inch-sizes. Made of forged high quality steel for tubes with an outside-diameter of: 3/16", 1/4", 5/16", 3/8", 7/16", 1/2", 5/8", 3/4"

These diameters can be flared as well as swaged. The unit is supplied in a special sturdy plastic case.

Part No 9881575

RF-275-FS

公制尺寸的45度骤燃和型锻工具。

高质量锻钢制造，用于外部直径为 3/16", 1/4", 5/16", 3/8", 7/16", 1/2", 5/8", 3/4" 英寸的圆管

以上这些尺寸均可进行骤燃和型锻。供货以坚固的塑料箱包装

部件号 9881575

208.00

RF-275-FSM

45° Flaring and Swaging Tool in metric-sizes. Made of forged high quality steel for tubes with an outside-diameter of: 6 - 8 - 10 - 12 - 15 - 16 mm

These diameters can be flared as well as swaged. The unit is supplied in a special sturdy plastic case.

Part No 9881574

RF-275-FSM

公制尺寸的45度骤燃和型锻工具。

高质量锻钢制造，用于外部直径为 6-8-10-12-15-16毫米的圆管

以上这些尺寸均可进行骤燃和型锻。供货以坚固的塑料箱包装

部件号 9881574

208.00



RF-500-FB/RF-500-FBM

RF-500-FB

45° Flaring Tool in inch-sizes. Made of forged high quality steel for tubes with an outside-diameter of: 3/16", 1/4", 5/16", 3/8", 1/2", 5/8", 3/4"

The unit is supplied in a sturdy plastic case.

Part No 9881577

RF-500-FB

所有公制尺寸的45度开张和型锻工具。高质量锻钢制造，用于外部直径为 3/16, 1/4, 5/16, 3/8, 1/2, 5/8, 3/4 英寸的圆管

供货以坚固的塑料箱包装

部件号 9881577

156.00

RF-500-FBM

45° Flaring Tool in metric-sizes. Made of forged high quality steel for tubes with an outside-diameter of: 6 - 8 - 10 - 12 - 15 - 16 mm

The unit is supplied in a sturdy plastic case.

Part No 9881576

RF-500-FBM

所有公制尺寸的45度开张和型锻工具。高质量锻钢制造，用于外部直径为 6-8-10-12-15-16 毫米的圆管

供货以坚固的塑料箱包装

部件号 9881576

156.00

Tube Bending Springs

弯管弹簧

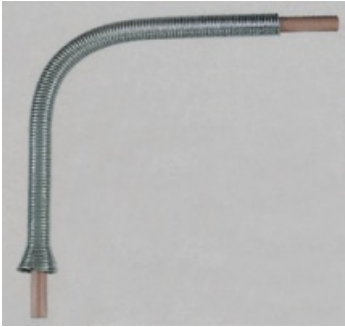

BS-6

Designation 名称	O.D. tube 管外径 inch/英寸	tube-Ø mm/毫米	Part No 部件号	CHF
BS-4	1/4"	6	9881648	6.60
BS-5	5/16"	8	9881642	7.20
BS-6	3/8"	10	9881641	8.00
BS-7	7/16"		9881640	8.20
BS-8	1/2"	12	9881639	9.10
BS-10	5/8"	16	9881638	10.60
BS-12	3/4"		9881637	11.30

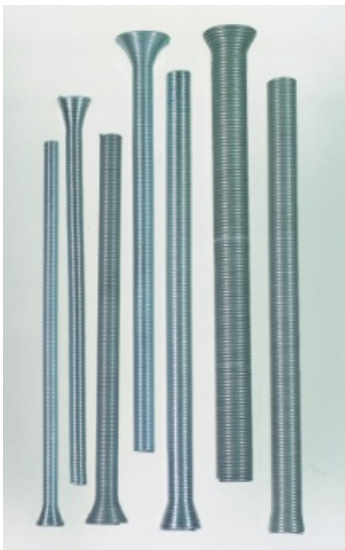

BS-77

BS-77
Set of all 7 sizes packed in plastic bag
Part No 9881635

BS-77
7种尺寸套件塑料袋包装
部件号 9881635

57.50

BS-77M
Set of metric sizes (BS-4, BS-5, BS-6, BS-8, BS-10) packed in plastic bag
Part No 9881636

BS-77M
公制尺寸套件(BS-4, BS-5, BS-6, BS-8, BS-10)塑料袋包装
部件号 9881636

38.50

BS-44
Set of 4 sizes (BS-4, BS-6, BS-8, BS-10) packed in plastic bag
Part No 9884890

BS-44
4种尺寸套件(BS-4, BS-6, BS-8, BS-10), 塑料袋包装
部件号 9884890

32.50

Tube Benders

弯管器



RFA-364-FH-04

Designation 名称	Ø 直径	Part No 部件号	CHF
RFA-364-FH-04	1/4"	9881670	87.50
RFA-364-FH-05	5/16"	9881669	89.00
RFA-364-FH-06	3/8"	9881668	118.00
RFA-364-FH-08	1/2"	9881667	146.00
RFA-364-FH-10	5/8"	9881666	210.00
RFA-364-FH-12	3/4"	9881665	257.00



RFA-368-FH

RFA-368-FH
Triple Header Tube Bender
Bends all tubes with an O.D tubing diameter of 1/4", 5/16" and 3/8" to 90° bend
Part No 9881657

RFA-368-FH
手动式弯管器
用于管外径1/4", 5/16及3/8英寸能弯90度
部件号 9881657

80.50

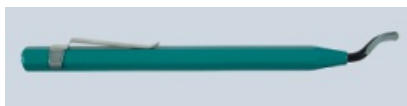
Tubing Tools
管工具

RFA-209-STYLO

RFA-209-STYLO
Handy deburrer. Blade can be swivelled.
Part No 9883750

RFA-209-STYLO
便利打磨器 (deburrer)。刃头可转动。
部件号 **9883750**

CHF
26.40

Expander Tool
扩展器工具

14297/14298

14297 Expander-tool-set
complete with expander-plier and 7 heads in practically and handy steel box to cover all inch size tubes of 3/8", 1/2", 5/8", 3/4", 7/8", 1", 1 1/8" diameter.
Part No 9881688

14297扩展器-工具-组成套
包括扩展器夹和7个夹头，包装于适用方便的工具盒中。可供所有3/8", 1/2", 5/8", 3/4", 7/8", 1", 1 1/8"英寸等直径的管使用。

部件号 **9881688**

1008.00

14298 Expander-tool-set
complete with expander-plier and 7 heads in practically and handy steel box to cover all metric tubes of 10, 12, 15, 16, 18, 22, 28 mm diameter.
Part No 9881687

14298扩展器-工具-组成套
包括扩展器夹和7个夹头，包装于适用方便的工具盒中。可供所有公制尺寸10, 12, 15, 16, 18, 22, 28毫米等直径的圆管使用。

部件号 **9881687**

1008.00

Designation 名称	Ø 直径	Part No 部件号	
14297-01	3/8"	9881686	205.00
14297-02	1/2"	9881685	205.00
14297-03	5/8"	9881684	205.00
14297-04	3/4"	9881683	205.00
14297-05	7/8"	9881682	205.00
14297-06	1"	9881681	205.00
14297-07	1 1/8"	9881680	273.00
14297-08	1 3/8"	4496362	273.00
14297-09	1 5/8"	4496371	273.00
14298-01	10 mm	9881679	205.00
14298-02	12 mm	9881678	205.00
14298-03	15 mm	9881677	205.00
14298-04	16 mm	9881676	205.00
14298-05	18 mm	9881675	205.00
14298-06	22 mm	9881674	205.00
14298-07	28 mm	9881673	273.00
14298-08	25 mm	9882286	273.00
14298-09	42 mm	4503210	273.00

14297-01
Torque wrenches
链型扳手

TW-8

TW-8
The complete Torque wrenches kit in a handy case. Torque: 10-75 Nm
Size of wrenches: 17, 19, 22, 24, 26, 27, 29 mm
Part No 4666034

TW-8
完整的转力矩扳手工具存放於便利盒内
扭矩: 10-75 Nm
扳手尺寸: 17, 19, 22, 24, 26, 27, 29毫米

部件号 **4666034**

175.00

BR-4IN1

BR-4IN1
This brush cleans 1/2" or 3/4" tubes on the inside as well as on the outside without changing the tool. Release fast and easy copper parts from dirt and residues like fat and corrosion.
Part No 4677621

BR-4IN1
本型号的刷子可以在不用借助任何其他工具的情况下清洁1/2"和3/4"管子的内壁和外壁，并可以快速将污垢以及机油和锈渍与金属脱离。

部件号 **4677621**

13.80

Hand Tools

手提工具



R6950

R6950
Ratchet wrench
Part No 9881547

R6950
棘轮扳手
部件号 9881547

CHF
125.00



RMK

RMK
Refrigeration socket set
Complete set as per picture, 20 pieces,
metric sizes
Part No 4678792

RMK
冷冻机承窝(插座)套
全套如图, 供20件, 公制尺寸
部件号 4678792

349.00

R6725ZK
同上, 但以英寸为尺寸
部件号 9881532

349.00



RFA-127-C

RFA-127-C
Ratchet wrench
Square: 1/4" x 3/8" and
3/16" x 5/16"
Part No 9881466

RFA-127-C
棘轮扳手
平方: 1/4 x 3/8 英寸, 及
3/16 x 5/16 英寸
部件号 9881466

24.30



RFA-127-OFFSET

RFA-127-OFFSET
Ratchet Wrench offset
Square: 1/4" x 3/8" and
3/16" x 5/16"
Part No 4506201

RFA-127-OFFSET
特别角度双向操作专用扳手
尺码: 1/4 x 3/8 英寸, 及
3/16 x 5/16 英寸
部件号 4506201

27.00

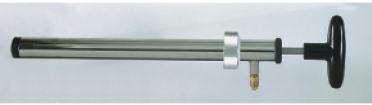

21702

Charge Oil Pumps

21702
The REFCO charge-oil pump eliminates the danger of drawing air and moisture into a refrigeration system when charging a compressor with oil. It charges without pumping the compressor down thus reducing charging time by over 70%. It pumps one quart in 20 full strokes of the piston.
Part No 9881559

充气油泵

21702
REFCO充气泵消除了在进行压缩机充油时将空气和湿气吸入冷冻系统的危险。在充油时不需抽取压缩机, 这样便将充油时间减少了70%。充油一夸特只需将此活塞抽压20次。

部件号 9881559

244.00



21751

21751
Change-oil pump
Part No 9881557

21751
换油泵
部件号 9881557

219.00

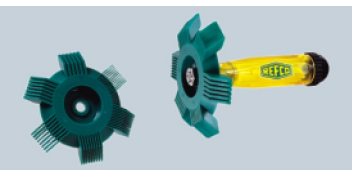

14142

Fin Comb

14142
Fin comb to fit all sizes, with additional replace spare comb, in plastic bag.
Part No 9881562

翅梳

14142
适用于各种尺寸的翅梳, 附可更换的备用梳, 塑料袋包装。
部件号 9881562

53.00



14225

Mirror

14225
Circular Pocket Mirror, telescopic \varnothing 1 1/2",
L = 185-500 mm
Part No 9881560

镜子

14225
环状口袋镜, 伸缩直径1 1/2 英寸,
长度=185-500毫米
部件号 9881560

25.80

Solenoid Valve Operating Magnet



SVOM-18

SVOM-18
The ideal addition to the professional service engineer's toolkit.
- the quickest and easiest way to operate solenoid valves manually
- converts electrically operated solenoid valves in hand operated valves in seconds
- Proven design which fits most of solenoid valves
Part No 4660507

电磁阀磁性控制器

SVOM-18

此产品专为维修工程师而设的维修工具, 最快捷及方便手动操作电磁阀, 能于几秒时间内手动改变控制电磁阀电流。此设计已证实适合大部分电磁阀。

部件号 4660507

67.50



13250

13250

The portable gas-oxygen kit gives you the possibility to obtain a constant immediate regulation of the flame and the temperature. The customer-owned oxygen cylinder (EU-standard) can be exchanged by your dealer for a refilled bottle. Only pay the filling. You also have the possibility of filling small oxygen cylinder from a large standard cylinder by using the oxygen charging adapter f/f (13251).

The one-way gas cartridge can be bought from REFCO or at your local gas supplier. Hold a number of gas cartridges in stock.

The soldering kit consists of:

- Rack
- Oxygen cylinder 2.5 l (content 500 l oxygen)
- Pressure regulator for oxygen
- Pressure regulator for gas with nonreturn valve
- Hose set 2 m with flash-back arrester
- Burner handle
- Burner nozzle size 1
- Safety goggles
- Lighter

Dimensions: 46 x 28 x 15 cm

Weight: 7.8 kg

Flame temperature: 2830 °C

Part No 9881719

13847

One-way gas cartridge (600 ml) for soldering unit 13250

Part No 4661287



13847

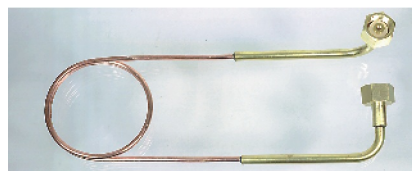

13251

13251-f/f

Oxygen charging adapter f/f

Part No 9882024

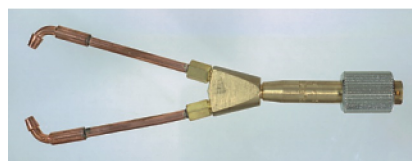

13252

13252

Two-way burner

Part No 9881716



13253

13253

One-way burner for gas-oxygen

Size 1 (Standard) Part No 9883818
Size 3 Part No 9881715



13254

13254

Handle complete without burner for gas-oxygen

Part No 9881714

13250

便携式氧气工具，立即提供火力和温度的稳定性。氧气樽是可以再充气的，客户只需交充气费用。也可以使用充气转换器（13251）由大的氧气樽转到细的氧气樽。一次性的气樽也可以向瑞士威科或你的本地供应商购买。

烧焊工具包括：

- 架
- 2.5公升氧气樽（内有500公升氧气）
- 氧气专用的压力调节器
- 压力调节器防止气体倒流
- 2米长的喉有防止回流工能
- 燃烧柄
- 1分烧焊咀
- 安全眼镜
- 点火器

尺寸：46 x 28 x 15 厘米

重量：7.8公斤

火力：2830度

部件号 9881719

13847

单次性气樽（600毫升）

部件号 4661287

13251-f/f

充氧调节器f/f

部件号 9882024

13252

双向燃烧器

部件号 9881716

13253

单向氧气燃烧器

1号（标准）
3号

部件号

9883818

9881715

CHF

1307.00

22.90

181.00

237.00

98.50

98.50

142.00

Propane Torch

丙烷气炬烧



16847



16867

16847
Propane one-way cartridge
Part No 9881693

16867
MAPP gas cylinder
Part No 4661261

16847
丙烷气罐
部件号 **9881693**

16867
丙烷气罐
部件号 **4661261**



16866

16866
Heavy duty spark igniting head propane torch, pressure regulated for consistent operation.
Part No 4661415

16866
重型的丙烷气炬火，压力已经调节以适应持续性操作。
部件号 **4661415**

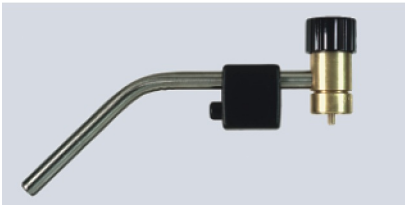

16856

16856
Spark igniting swivel head torch for propane and MAPP gas cylinder, pressure regulated for consistent operation. Burn tube rotates 360 degrees.
Part No 9884868

16856
丙烷气及混合气炬火，星点火旋转头，压力已经调节以适应持续性操作，燃烧管可作360度旋转。

部件号 **9884868**



16859

16859
Swirl flame brazing torch, to be used with propane and MAPP gas cylinder, pressure regulated
Part No 9884869

16859
盘绕火焰-焊气炬，用于丙烷和混合气上，压力已经调节。

部件号 **9884869**

CHF
22.40

36.00

219.00

165.00

134.00



Auto Valves
Tools and Accessories
Universal Relay

自动阀
工具与附件
普及型继电器

威科制造商
REFCO Manufacturing Ltd.
Industriestrasse 11
CH-6285 Hitzkirch (Switzerland)

Phone
Fax
info@refco.ch

+41 41 919 72 82
+41 41 919 72 83
www.refco.ch

Ball Service Valve

球形维修阀

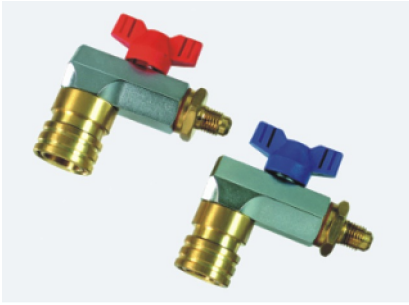

CX-AUTO-1/4 SAE

Trouble free service work when using this new service valve for A/C systems charged with R134a.

REFCO offers all common threads on these Auto-Service-Valves.

CX-AUTO-B-1/4" SAE
Auto-valve 1/4" SAE connection, blue
Part No 9881193

CX-AUTO-R-1/4" SAE
Idem, red.
Part No 9881191

CX-AUTO-B-3/8" SAE
Auto-valve 3/8" SAE connection, blue
Part No 9881190

CX-AUTO-R-3/8" SAE
Idem, red.
Part No 9881189

CX-AUTO-B-M 14x1.5 mm
Auto-valve female
M14 x 1.5 mm, blue
Part No 9881188

CX-AUTO-R-M 14x1.5 mm
Idem, red.
Part No 9881187

V-R-B-001/10
HNBR O-Ring suitable for low side valve,
blue and RC01-B.
Part No 9884847

V-R-R-002/10
HNBR O-Ring suitable for high side
valve, red and RC01-R.
Part No 9884848

Automotiv Ball Service Valve



RC01-B



RC01-R

RC01-B
Compact field service coupling for
R134a. Provides a safe and reliable
evacuating and charging.
Connection 1/4" SAE, 6 balls,
chrome plated, blue.
Part No 9884949

RC01-R
Idem, red.
Part No 9884948

RC02-B
Idem, blue, connection
M14 x 1,5
Part No 4494599

RC02-R
Idem, red.
Part No 4494602



RC02-B

使用本新型维修阀进行以充气的A/C系统清除障碍的维修工作。

REFCO提供所有这些自动维修阀的普通螺纹阀。

CX-AUTO-B-1/4 英寸SAE
自动阀1/4 英寸SAE连接, 蓝色
部件号 9881193

CX-AUTO-R-1/4 英寸SAE
同上, 红色
部件号 9881191

CX-AUTO-B-3/8 英寸SAE
自动阀3/8 英寸SAE连接, 蓝色
部件号 9881190

CX-AUTO-R-3/8 英寸SAE
同上, 红色
部件号 9881189

CX-AUTO-B-M 14x1.5毫米
自动阴(内) 阀
M 14x1.5毫米, 蓝色
部件号 9881188

CX-AUTO-R-M 14x1.5毫米
同上, 红色
部件号 9881187

V-R-B-001/10
HNBR O-形环, 适用于低边阀
蓝色
部件号 9884847

V-R-R-002/10
HNBR O-形环, 适用于高边阀
红色
部件号 9884848

Automotiv 维修球阀

RC01-B
密集型场地维修耦合器, 用于
R134a。提供安全可靠的排气
和充气。
连接为1/4英寸SAE, 6枚球, 镀铬,
蓝色。
部件号 9884949

RC01-R
同上, 红色。
部件号 9884948

RC02-B
维修球阀压低冲注接头/连开关阀
(蓝色)
部件号 4494599

RC02-R
高压冲注接头/连开关阀(红色)
部件号 4494602

CHF

80.50

80.50

80.50

80.50

80.50

80.50

36.00

42.00

103.00

103.00

103.00

103.00

Accessories
附件

13400
13400

This Acid-Test-Kit includes 5 bottles to make 5 checkups of refrigerant-oil to find out if acid or o.k.

Put 12 drops of oil into one bottle; color of the liquid will change to
 - yellow = Acid, Oil not o.k.
 - green = still o.k.
 - blue = very good Oil o.k.

Can be used for mineral and synthetic oils.

Part No 9881446

13400

此种酸检验包共含5瓶，可进行5次制冷剂油剂检验，以确认酸是否正常。

将12滴油注入其中1瓶，液体的颜色将改变：
 -黄色 = 酸不好
 -绿色 = 还可以
 -蓝色 = 良好，油正常

适用于矿物和合成油

部件号 **9881446**

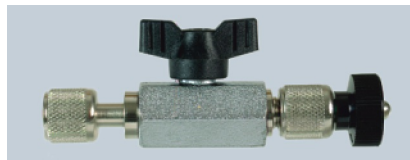
CHF
53.00
Access Valve-Tools for 1/4" SAE

32520
32520

Valve core replacing tool
Part No 9880893

32520

阀心更换工具
 部件号 **9880893**

118.00
32520-555

Gasket O-ring set complete
Part No 9880892

32520-555

成套垫圈O形环组
 部件号 **9880892**

16.40

A-31999-R
A-31999-R/10

Valve core red with Teflon and Neopren gasket for HCFC (R12, R22, R502) for all temperatures and for HCF = R134a up to 120° celsius. Bag containing 10 pcs.

Part No 9883488

A-31999-R/10

红色阀心，聚四氟乙烯和氯丁二烯橡胶垫圈用于各种温度下的HCFC (R12,R22,R502)，以及HCF=R134a 达120摄氏度。袋装10枚。

部件号 **9883488**

13.80
A-31999-R/100

Valve core red, 100 pcs.
Part No 9883854

A-31999-R/100

红色阀心，100枚
 部件号 **9883854**

122.00

A-32000
A-32000

Valve core tool screwdriver contains 6 extra cores and one extra core remover and tap.
Part No 9880890

A-32000

阀心工具螺丝刀，包括6个附加阀心和1个附加阀心移换器及塞子。
 部件号 **9880890**

29.60
A-32000-01/10

Core remover
Part No 9884849

A-32000-01/10

阀心移换器
 部件号 **9884849**

39.00

A-32000-01

A-32000-02
A-32000-02/10

Thread cutter
Part No 9884850

A-32000-02/10

螺纹切割器
 部件号 **9884850**

39.00
Universal Relay

ICG-220
Features

- Easy to install... Can be mounted on the fence of the compressor with quick "snap-on-bracket"... or installed in any convenient location by using screws through the mounting holes.
- Can be used with or without a start capacitor.

普及型继电器
功能

- 安装便利...可使用快速“嵌入式托架”安装于压缩机的栏板上...或使用螺丝刀通过安装孔安装于任何方便之处。

- 使用或不使用启动电容器均可

ICG-220

Universal relay can be used on all hermetic compressors of any brand for capacities of 1/12 to 1/2 H.P. Saves money on your stocks as all other relays are eliminated. 220 V - 50 cycles.

Part No 9881406

ICG-220

普及型继电器，适用于任何品牌能量从1/12至1/2马力的各类密封式压缩机。这是节省库存费用的选择，因无其他继电器可替代。220伏-50周

部件号 **9881406**

17.80
SPP-220

Universal power relay used on all window airconditioning units from 1/12 to 10 H.P. capacity. Voltage: 110-240 V

Part No 9881402

SPP-220

普及型电力继电器，适用于能量从1/12至10马力的各类窗式空调机组。这是节省库存费用的选择，因无其他继电器可替代。110-240伏

部件号 **9881402**

35.00

SPP-220



威科制造商
REFCO Manufacturing Ltd.
Industriestrasse 11
CH-6285 Hitzkirch (Switzerland)

Phone
Fax
info@refco.ch

+41 41 919 72 82
+41 41 919 72 83
www.refco.ch



Capillary Tubes
Access Valves

毛细管
插入阀

威科制造商
REFCO Manufacturing Ltd.
Industriestrasse 11
CH-6285 Hitzkirch (Switzerland)

Phone
Fax
info@refco.ch

+41 41 91972 82
+41 41 91972 83
www.refco.ch

Copper Capillary Tubing

铜毛细管



TC-26

Pure soft copper tube in coils of about 100 feet (30 m). Sealed and dehydrated small diameter plug-drawn copper capillary tubing, available in 100 foot exact length coils.

纯软铜管线圈，约100英尺（30米）长。密封脱水小直径插头铜毛细管，可提供整100英尺长度的线圈。

Specifications

规格

Designation 名称	Ø inch/英寸		Ø mm/毫米		Length per coil 每圈长度		Part No 部件号	
	inside	outside	内径	外径	feet /英尺	Meter/米		
TC-26	0.026	0.075	0.7	1.9	100	30	9881106	66.50
TC-31	0.031	0.078	0.8	2.0	100	30	9881105	72.00
TC-36	0.036	0.083	0.9	2.1	100	30	9881104	79.00
TC-42	0.042	0.089	1.0	2.2	100	30	9881103	84.50
TC-44	0.044	0.090	1.1	2.3	100	30	9881102	87.50
TC-49	0.049	0.097	1.25	2.45	100	30	9881101	96.00
TC-50	0.050	0.098	1.3	2.5	100	30	9881100	103.00
TC-55	0.055	0.102	1.4	2.6	100	30	9881099	109.00
TC-59	0.059	0.106	1.5	2.7	100	30	9881098	116.00
TC-64	0.064	0.110	1.6	2.8	100	30	9881097	120.00
TC-70	0.070	0.118	1.8	3.0	100	30	9881096	127.00
TC-75	0.075	0.122	3.1	3.1	100	30	9881095	135.00
TC-80	0.080	0.125	3.2	3.2	100	30	9881094	139.00
TC-90	0.090	0.138	3.5	3.5	100	30	9881093	145.00

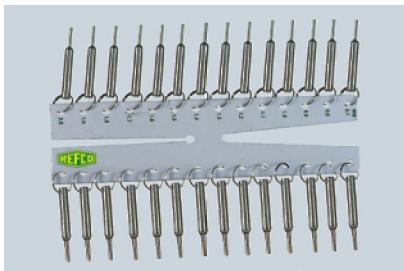

10971

Capillary Tube Gauge

毛细管计量仪

10971

Cap Gauge Tool to measure all capillary tubes in millimeter (mm) as well as inch sizes.
Part No 9881088

10971

帽形计量工具，以毫米或英寸测量所有毛细管
部件号 9881088

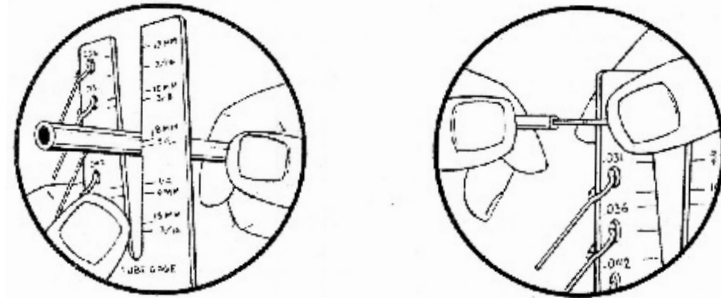

CHF

66.50

72.00

79.00

84.50

87.50

96.00

103.00

109.00

116.00

120.00

127.00

135.00

139.00

145.00

108.00



TCK-1000V

With O-ring-gasket Silver Brazing

O形环垫圈银铜焊

Capillary tube with Schrader-valve opener

配备施瑞德 (Schrader) 阀开启器的毛细管

All REFCO-capillary-tubes are equipped with O-rings. A twisting of the capillary tube during the connection is excluded.

所有REFCO毛细管都配备O形环。在连接过程中不会造成管的扭曲，从而在更换系统中任何控制器或在连接压力开关、计量仪、压力水控制器时避免了制冷剂的流失

To prevent loss of refrigerant when changing any controls and to connect pressure-switches, gauges, pressurized water controls etc. on your systems.

Diameter inside 1.5 mm
Diameter outside 3.0 mm

内径 1.5 毫米
外径 3.0 毫米

Capillary tube with 2 nuts 1/4" SAE with or without access Schrader-valve opener

配备2个 1/4英寸SAE的螺母 配备或不配备施瑞德阀开启器



Designation 名称	Length 长度	Connection 连接	Depressor 压器	Part No 部件号	
TCK-500-V	500mm	1/4" SAE=7/16" UNF	Yes/有	9881117	11.50
TCK-1000-V	1000mm	1/4" SAE=7/16" UN	Yes/有	9881116	12.90
TCK-1500-V	1500mm	1/4" SAE=7/16" UNF	Yes/有	9881115	14.50
TCK-2000-V	2000mm	1/4" SAE=7/16" UNF	Yes/有	9881114	17.10
TCK-3000-V	3000mm	1/4" SAE=7/16" UNF	Yes/有	9881113	19.80
TCK-500-V	500mm	1/4" SAE=7/16" UNF	No/无	9881112	11.30
TCK-1000-V	1000mm	1/4" SAE=7/16" UN	No/无	9881111	12.40
TCK-1500-V	1500mm	1/4" SAE=7/16" UNF	No/无	9881110	14.20
TCK-2000-V	2000mm	1/4" SAE=7/16" UNF	No/无	9881109	16.90
TCK-3000-V	3000mm	1/4" SAE=7/16" UNF	No/无	9881108	19.00

Accessories

附件

TCK-005/10

TCK-005/10

adapter for brazing with O-ring loose
Part No 9881107

用于O形环松脱铜焊的调节器
部件号 9881107

22.00

TCK-005-V/10

TCK-005-V/10

as above, with depressor
Part No 9884745

同上, 配阀
部件号 9884745

35.00

Polyamid capillary tube

聚酰胺毛细管

P-2001

P-2001

Polyamid capillary confectioning set Capillary connection lines can be made easy and directly when servicing a refrigeration unit.
Temperature range -40 - +80°C
Working pressure 30 bar

聚酰胺毛细管调制套组的毛细连接螺纹可在对冷冻系统进行维修时直接便利地制作。
温度范围-40至+80摄氏度。
工作压力30巴

Set consisting of:

成套包括:

1 pc sturdy plastic case with special insert
100 pcs nuts NS4-4 1/4" SAE
100 pcs nipples M6 with O-ring
100 pcs tightening nuts M6
50 metres polyamid capillary hose
Part No 9883690

1枚 坚固塑料箱特制内部设置
100枚 NS4-4 1/4英寸SAE螺母
100枚 M6螺纹接套及O-形环
100枚 M6上紧螺母
50米 聚酰胺毛细软管
部件号 9883690

641.00

Spares:

备件:

P-2001-NS4-4-1/4/100

P-2001-NS4-4-1/4/100

100 pcs nuts NS4-4-1/4" SAE
Part No 9883686

100 枚NS4-4-1/4英寸SAE螺母
部件号 9883686

163.00

P-2001-110/100

P-2001-110/100

100 pcs nipples M6 with O-ring
Part No 9883687

100 M6螺纹接套及O-形环
部件号 9883687

285.00

P-2001-120/100

P-2001-120/100

100 pcs tightening nuts M6
Part No 9883688

100 M6上紧螺母
部件号 9883688

134.00

P-2001-504

P-2001-504

50 m polyamid capillary hose
Part No 9883689

50米聚酰胺毛细软管
部件号 9883689

123.00

Polyamid capillary connection line with 2 nuts 1/4" SAE without valve

聚酰胺毛细管连接螺纹及2个 1/4英寸SAE无阀螺母

Designation 名称	Length 长度	Part No 部件号	
TCP-500	500	9883691	11.00
TCP-1000	1000	9883692	12.20
TCP-1500	1500	9883693	13.80

名称	长度	部件号	
TCP-500	500	9883691	11.00
TCP-1000	1000	9883692	12.20
TCP-1500	1500	9883693	13.80



P-2001

Schrader-Valves 1/4" SAE



A-31999-R

A-31999-R/10

Valve Core red with Teflon and Neopren gasket for HCFC (R12, R22, R502) for all temperatures and for HFC = R134a up to 120° Celsius.

Part No 9883488

A-31999-R/100

Valve Core red, 100 pcs

Part No 9883854

Schrader-阀 1/4英寸 SAE

A-31999-R/10

红色阀心及聚四氟乙烯和氯丁二烯橡胶垫圈用于各种温度下的HCFC (R12, R22, R502), 以及HCF=R134a达120摄氏度。

部件号 9883488

A-31999-R/100

红色阀心, 100枚

部件号 9883854

CHF

13.80

122.00



A-31999-G

A-31999-G/10

Valve Core green suitable only for HFC = R134a refrigerant gas with green Teflon and flat HNBR gasket; suitable for all applications in connection with R134a systems for temperatures up to 120°C.

Part No 9880864

A-31999-G/100

Valve Core green, 100 pcs.

Part No 9883873

A-31999-G/10

仅适用HFC=R134a制冷气体的绿色阀心, 带绿色聚四氟乙烯扁平HNBR橡胶垫圈; 适用于所有连接于R134a的系统温度达120摄氏度的电器。

部件号 9880864

A-31999-G/100

绿色阀心, 100枚

部件号 9883873

16.80

150.00

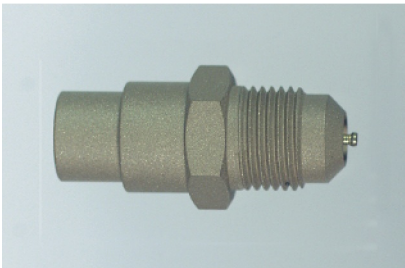

A-40720

Access Valves 3/8" SAE "King-Size"

The new designed and created 3/8" SAE access fitting series grants interventions on commercial refrigeration units much more easy by saving substantial time, since the opening of the valves are much wider. Necessary tools from REFCO with all 3/8" SAE connections as well as depressors on HCL6 charging lines 3/8" SAE are available now.

A-40720/5

access fitting complete with valvecore and quick seal cap for tubes inside 3/8"; outside Ø 5/8" and 3/4".

Part No 9884814

插入阀

3/8英寸SAE "特大号"

全新的设计和创造, 3/8英寸SAE插入阀零配件系列更容易插入商业型冷冻单位, 由于阀门的开口更宽大, 可节省相当可观的时间。目前可提供所有3/8英寸SAE连接和HCL6充气线3/8英寸SAE压器的威科必须工具。

A-40720/5

全套插入阀零配件包括内径3/8英寸、外径5/8和3/4英寸管的阀心和快速封帽。

部件号 9884814

71.50

“Super-Tap” Piercing Valve for Domestic Appliance



LT-4G

Suitable to be fitted permanently on to sealed units.

This type of piercing valve is absolutely tight and very easy to install.

Benefits:

- Body manufactured from forged brass
- Valve spindle made from quality steel, hardened
- O-ring sealed
- Easy to install with allen-key 3 mm
- Valve spindle to be operated with same allen-key 3 mm
- Built-in valve spindle avoids a too deep piercing into the tube or a too big opening of the valve
- Connection 1/4" SAE, therefore fits all brands of charging lines
- No additional adapter or tool required

超级攻螺丝钻阀 供家用电器用

适合于永久性安装于密封的机组上

这种类型的钻阀绝对紧固并便于安装.

优点:

- 阀体以锻铜制造
- 阀轴由高质钢制造, 已强化
- O-形环封闭
- 具有3毫米allen套栓, 便于安装
- 阀轴使用同样3毫米allen套栓 (Allen key) 操作
- 内置阀轴避免过深钻孔进入管内, 或在阀上开口过大连接为1/4英寸SAE
- 因而符合所有型号的充气线
- 不需要额外的调节器或工具

CHF



LT-4G

LT-3G/10
Valve for 5 mm = 3/16" tube
Part No 9883993

LT-4G /10
Valve for 6 mm = 1/4" tube
Part No 9883994

LT-5G/10
Valve for 8 mm = 5/16" tube
Part No 9883995

LT-6G/10
Valve for 10 mm = 3/8" tube
Part No 9883996

Packing:
10 pieces in one carton including one allen-key 3 mm.

LT-01/10
Gasket only
Part No 9884871

LT-3G/10
用于5毫米=3/16英寸管的阀
部件号 **9883993**

LT-4G /10
用于6毫米=1/4英寸管的阀
部件号 **9883994**

LT-5G/10
用于8毫米=5/16英寸管的阀
部件号 **9883995**

LT-6G/10
用于10毫米=3/8英寸管的阀
部件号 **9883996**

包装:
10枚装箱, 包括1枚3毫米allen套栓

LT-01/10
垫圈
部件号 **9884871**

150.00

150.00

150.00

153.00

9.70



威科制造商
REFCO Manufacturing Ltd.
Industriestrasse 11
CH-6285 Hitzkirch (Switzerland)

Phone
Fax
info@refco.ch

+41 41 919 72 82
+41 41 919 72 83
www.refco.ch

Pressure
Conversion table for pressure units used in the field of refrigeration

压力
供冷冻领域使用的压力单位转换表

from/到	to/从	bar/巴	mbar/毫巴	Pa/帕斯卡	kPa/公斤帕斯卡	psi/(平方英寸/磅)
1 bar/1巴		1	1000	100 000	100	14,5
1 mbar/1毫巴		0,001	1	100	0,1	0,0145
1 Pa/1帕斯卡		0,00001	0,01	1	0,001	0,000145
1 kPa/1公斤帕斯卡		0,01	10	1000	1	0,145
1 psi/1(平方英寸/磅)		0,069	69	6900	6,9	1
1 Torr/1毛		0,00133	1,3	133,3	0,1333	0,0193

Further relations
1 Torr = 1 mmHg
1 Torr = 1000 Micron
1 Micron = 0,00133 mbar

互换关系:
1 毛 = 1 毫米水银
1 毛 = 1000 毫米
1 微米 = 0,00133 毫巴

Common Threads

Flaring connections

Copper connection to fit 90°Flair copper tube and nut SAE (UNF) is the thread corresponding to the international standard for refrigeration according to DIN8904 and ASA B 1.1.

普通螺纹

开张接口

适合90度焊铜接头管和螺母SAE (UNF) 的螺纹与国际冷冻系统标准相符 (根据DIN8904和ASAB 1.1.)。

Thread 螺纹 UNF	US Specification 美国规格 SAE	o.d. (max. size) 外径 (最大尺寸) mm/毫米	core dia. (min. size) 心直径 (最小尺寸) mm/毫米	pitch number per inch 螺距数 (每英寸)	pitch 螺距 毫米 mm/毫米
7/16英寸 - 20 UNF	1/4英寸 SAE	11,079	9,738	20	1,270
1/2英寸 - 20 UNF	5/16英寸 SAE	12,667	11,328	20	1,270
5/8英寸 - 18 UNF	3/8英寸 SAE	15,839	14,348	18	1,411
3/4英寸 - 16 UNF	1/2英寸 SAE	19,012	17,330	16	1,588
7/8英寸 - 14 UNF	-	22,184	20,262	14	1,814
7/8英寸 - 14 UNF	5/8英寸 SAE	22,184	20,262	14	1,814
1英寸 - 14 UNF	3/4英寸 SAE	25,357	23,437	14	1,814
1 1/16英寸 - 14 UNF	-	26,947	25,024	14	1,814
1 1/8英寸 - 12 UNF	-	28,529	26,284	12	2,117
1 1/4英寸 - 12 UNF	7/8英寸 SAE	31,704	29,459	12	2,117
1 3/8英寸 - 12 UNF	-	34,877	32,634	12	2,117
1 1/2英寸 - 12 UNF	1英寸 SAE	38,052	35,809	12	2,117

Temperature conversion table

温度转换表

°C in °F = °C x 1,8 + 32 = °F
°F in °C = (°F - 32):1,8 = °C

°C in °F = °C 乘 1,8 加 32 等于 °F
°F in °C = (°F 减 32):1,8 等于 °C

°C/摄氏度	°F/华氏度
100	212
95	203
90	194
85	185
80	176
75	167
70	158
65	149
60	140
55	131
50	122
45	113
40	104
35	95
30	86
25	77
20	68
15	59
10	50
4	39
0	32
-10	14
-20	-4
-30	-22
-40	-40
-50	-58
-60	-76
-273	-460

°C/摄氏度	°F/华氏度
212	100
200	93
190	88
180	82
170	77
160	71
150	66
140	60
130	54
120	49
110	43
100	38
90	32
80	27
70	21
60	16
50	10
40	4
30	0
20	-7
10	-12
0	-12
-10	-23
-20	-29
-30	-34
-40	-40
-50	-46
-60	-51
-112	-80
-460	-273

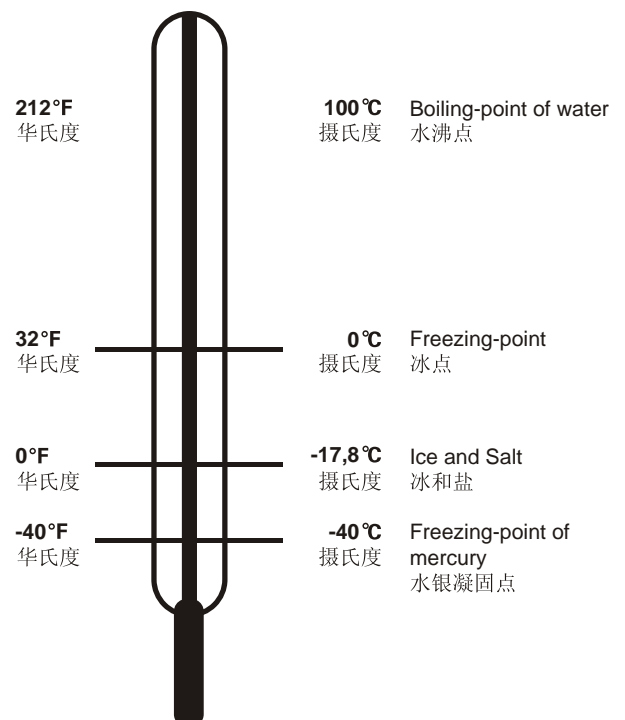

www.refco.ch





Manfred P. Ulrich
CEO

Refrigeration Service Products and Components

The Swiss enterprise REFCO was founded in 1972 and has successfully developed from a small company to a world wide renown supplier of Refrigeration Service Products and Components. Right from the beginning our aim has been to manufacture products of the highest quality and this is still in force today. A key event in our progress has been to absorb our customers' specific requirements and, with our technology, provide a product range unequalled for durability and reliability.

制冷服务产品和组件

REFCO 是一家成立于 1972 年的瑞士公司，并从一家小企业成功发展成为全球知名的制冷服务产品和组件的供应商。生产高品质的产品是我们至始至终一贯的目标。吸取客户的特殊需求，结合我们的技术，生产出持久耐用和安全领域里独一无二的产品是我们发展中的重中之重。





Swiss-Quality



郑重声明

[威科] 公司在此声明目前在市场上已出现 [威科] 的仿冒品。我们郑重提醒您注意，仿冒产品将不符合 [威科] 产品的质量标准。如果此类仿冒产品发生故障甚至破裂，[威科] 公司将拒绝承担任何责任。

请您与供应商再次确认您获得的是 [威科] 原厂生产的产品

Notice to users of REFCO equipment

Unfortunately we had to state an increasing number of copies of REFCO products in the market. We would like to point out to you that these copies do not meet the high quality standard of REFCO products. You therefore take a high risk of injury in case of malfunction or even burst of these copy-products and REFCO refuses any responsibility.

Please ensure with your supplier that you get only original REFCO products.

以上是由 SQS 瑞士质量及管理系统协会和 IQ Net 国际证书网络所颁发的证书，特此证实 [威科] 制造商所具备的管理系统已达到国际质量管理和质量保证标准 (ISO 9001) 以及国际环境管理质量标准 (ISO14001)。