

专注工业设备



设计 • 制造 • 进出口

工业设备

非标机电设备生产

设备包括：非标生产设备、木材加工设备、包装机械、医疗机械、半导体生产检测设备、进口设备的国产化、专用机电产品、工装夹具、设备测绘。

自动化生产线设计包括：机器人自动焊接、搬运、火焰切割、汽车玻璃涂胶、冲压搬运等、物料输送、自动点胶、自动喷漆、总装生产线等。

公司生产各种电动滑台、关节型工业机器人、机械式离合器，直线模组、直线导轨、滚珠丝杠、直线轴承、丝杠紧固件、单轴机器人等产品，应用于航空、汽车、冶金、矿山、电力、石化、煤炭、机械、交通、环保等行业。

业务范围

1. 工业自动化生产线 & 物流系统开发
2. 工业非标自动化设备 & 自动化机械产品开发
3. 工业净化设备
4. 测试测量类设备开发
5. 设备测绘 & CAD绘图
6. 进口设备国产化
7. 机械传动零部件销售
8. 设备改造
9. 工厂周转设备与工作台

厦门纬轩机电设备有限公司是一家集自动化机械产品开发、非标机械设计、机械传动零部件销售、机械零部件加工等业务为一体的高科技公司。

厦门纬轩机电设备有限公司向广大用户提供非标机械设备及生产线的研发制造，承接机器人焊接、搬运、火焰切割、汽车玻璃涂胶、喷涂、冲压搬运等生产线项目，可提供设计、生产、安装、调试等服务，可以选用KUKA、莫托曼、ABB等机器人。

进出口

进口工业贸易

专注全球知名品牌工业控制系统（DCS PLC），仪器仪表、传感器、编码器、高低压电气（断路器，接触器、开关等），无损检测仪（硬度、粗糙度、导电率、探伤仪等）、食品安全检测仪、环境检测仪、工业设备、机器人、气动液压自动化，CNC伺服控制等工业自动化装备与检测仪器进口贸易服务。

合作方式

提供品牌+型号+数量+目标价格→与供应商谈判→提供最佳价格与货期→确定合同→交货→完结

出口工业贸易

专注于非洲国家工业生产所需要的工业设备，机电设备，仪器仪表，高低压电气，金属材料，机器人，工装设备的供货贸易服务。

合作方式

提供品牌+型号+数量+目标价格→与供应商谈判→提供最佳价格与货期→确定合同→交货→完结

工业自动化生产线



工业非标自动化设备

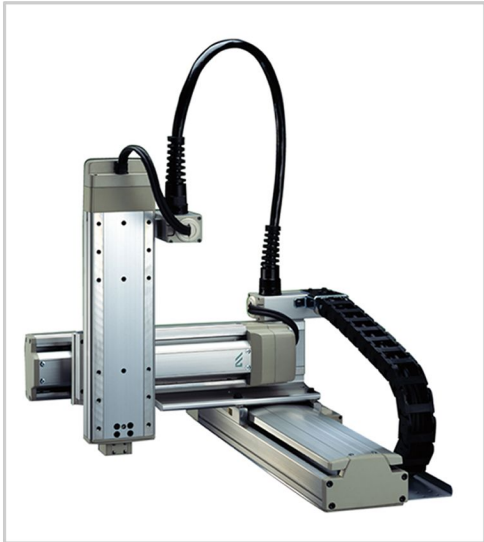
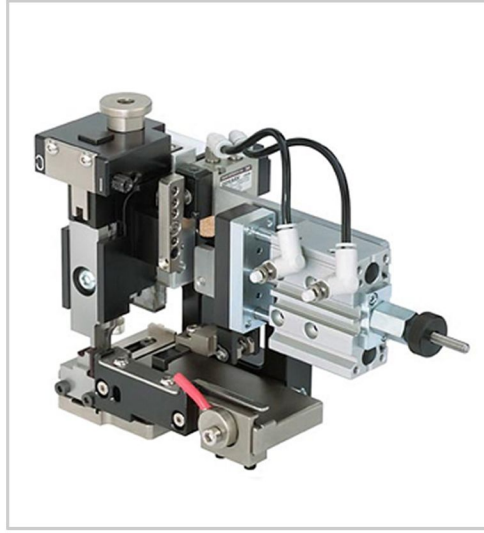

工业净化设备



其他工业设备



高低压电气



进口全球知名品牌的断路器、接触器、电容器、互感器、变压器等电气元件。

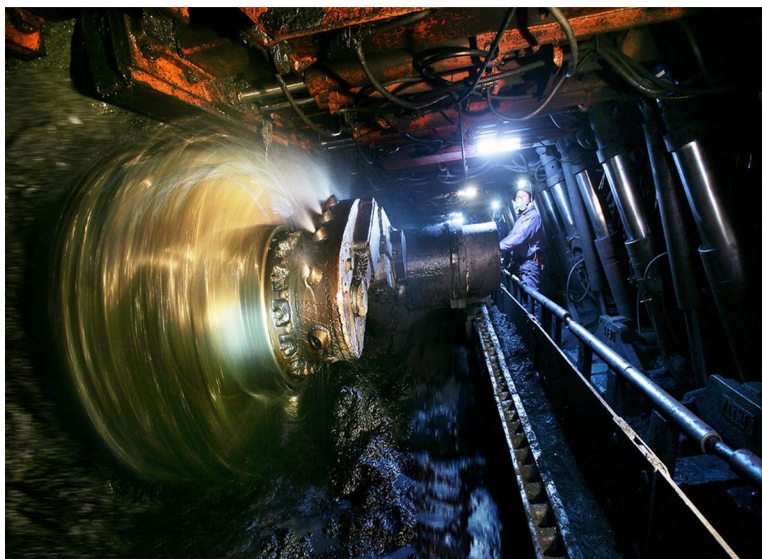

工业机器人



专业进口机器人销售与技术服务。

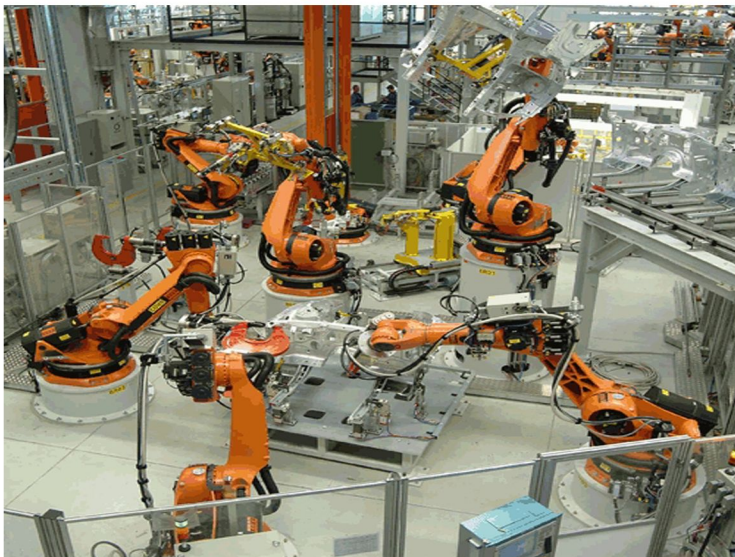

DCS PLC CNC



专注进口集散控制系统DCS、PLC、数控CNC系统集成备件贸易服务。



NDT无损检测仪



专注于进口无损检测仪器设备贸易服务。

OLYMPUS

DeFelsko

FLUKE

FOERSTER

FISHER



elcometer
inspection equipment

Krautkramer

proceq

PROTEC



COMETGROUP
Technology with Passion

TAYLOR HOBSON



ue
SYSTEMS INC

TRANSCAT



自动化

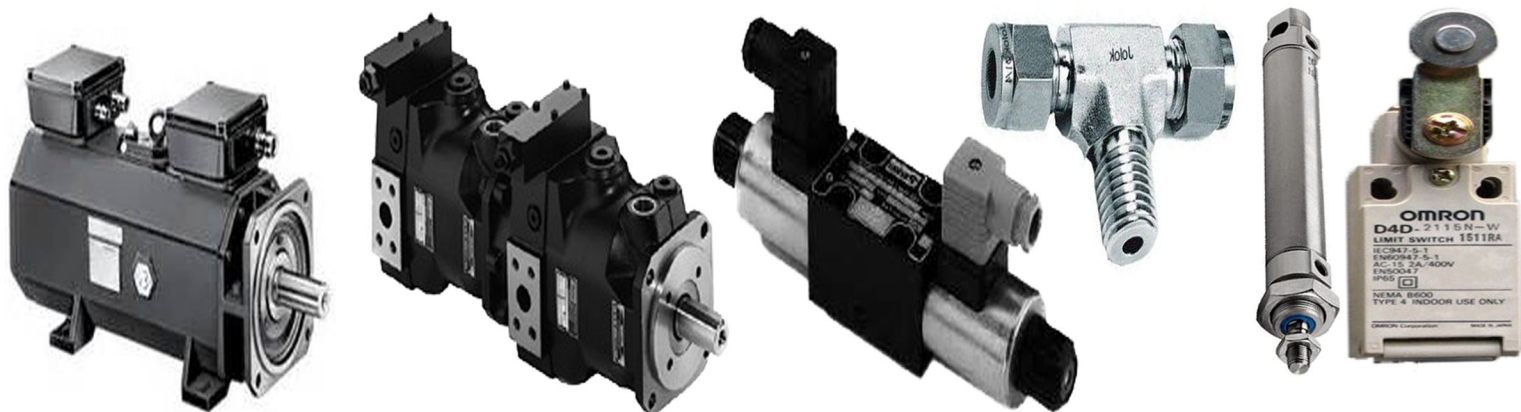

专注于进口电机、泵、阀、气缸、接头、行程开关等品牌备件贸易服务。

ASCO

COOPER

MOOG

Rexroth

Parker

VICKERS

SMC

BOSCH

**CONTINENTAL
HYDRAULICS**

Honeywell

GRUNDFOS

WILO

FORT VALE

KSB

pilz

Danfoss

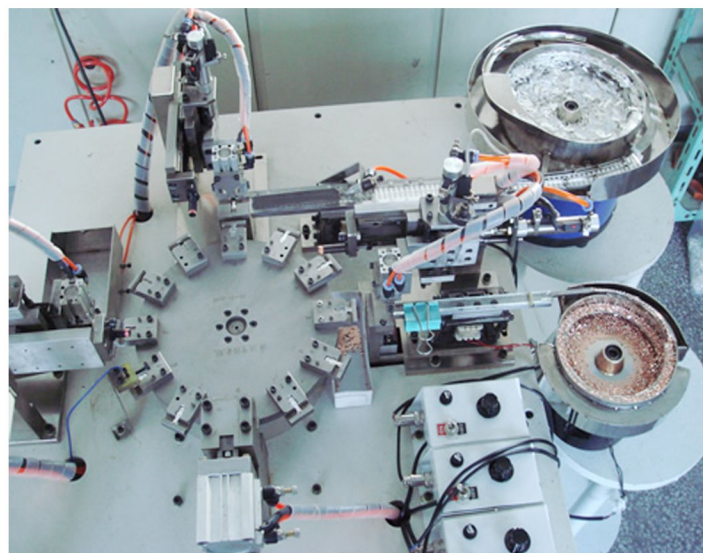

传感器、光电开关、编码器



进口传感器、光电开关、编码器等品牌备件贸易服务。



进口设备、量具

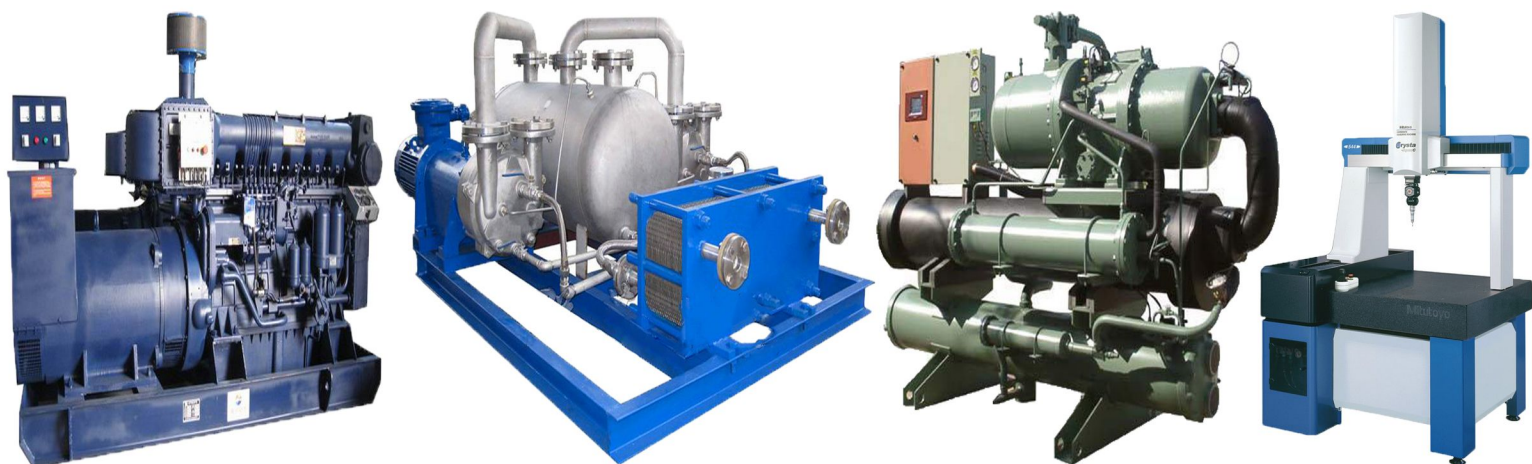

全球知名品牌工业设备、全球知名品牌量具。

SIEMENS

Schneider
ELECTRIC

TURCK

Mitutoyo

ABB

OMRON

EMERSON

Rexroth

EATON

GRUNDFOS



FANUC

cabur



**LENORD
+BAUER**

**MAGNETI
MARELLI**

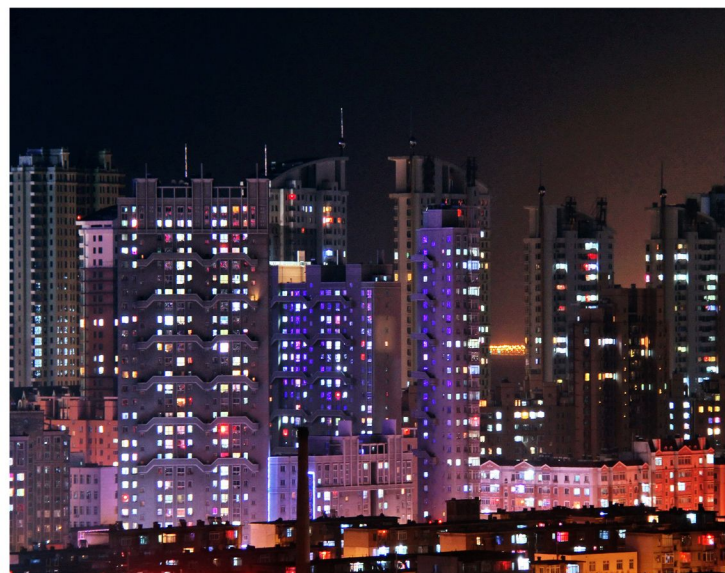

全球采购



AMERICA



美洲专职采购：午炎昌

我负责美洲地区产品询价格与采购，毕业于仪器与自控专业。只要您告诉我要采购的东西，不管有多大的困难，我一定全力以赴，找到满足你需要的产品。



EUROPE



欧洲专职采购：李昱丽

我负责德国，意大利，瑞士等地区产品询价格与采购，请您把你的采购需求告诉我，不论在欧洲的那个地区，我都会亲自到厂家去谈判，以达到您要求的产品与价格。

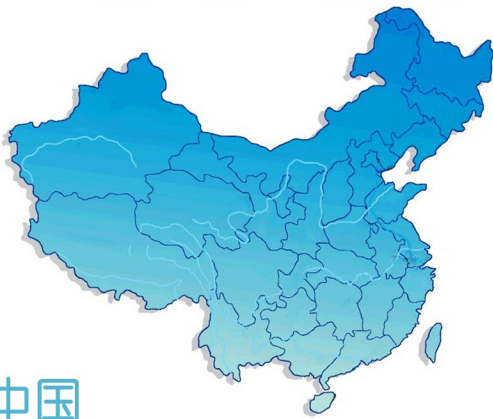

中国



中国采购总负责：欧阳朝日

我负责中国客户进口的采购跟踪与到货核对，不管仪器还是工控设备，备件，我都会一一与国外采购专员沟通与核实。以确保任何一个订单的准确性。



한국



韩国专职采购：刘亚俊

我负责韩国地区产品进出口的询价与采购，专注于韩国产品贸易服务。“诚信”是我的第一准则，我一定给予您最优质的服务，只有你想不到的，没有我找不到的。



专注工业设备 • 设计 • 制造 • 进出口