

N-Channel 60-V (D-S) MOSFET

Key Features:

- Low $r_{DS(on)}$ trench technology
- Low thermal impedance
- Fast switching speed

Typical Applications:

- White LED boost converters
- Automotive Systems
- Industrial DC/DC Conversion Circuits

PRODUCT SUMMARY		
V_{DS} (V)	$r_{DS(on)}$ (m Ω)	I_D (A)
60	13 @ $V_{GS} = 10V$	51
	18 @ $V_{GS} = 4.5V$	44



RoHS
COMPLIANT
HALOGEN
FREE

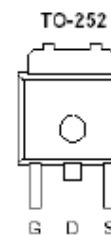
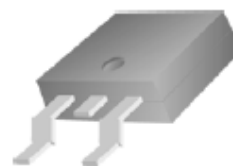

Top View

ABSOLUTE MAXIMUM RATINGS ($T_A = 25^\circ\text{C}$ UNLESS OTHERWISE NOTED)

Parameter	Symbol	Limit	Units
Drain-Source Voltage	V_{DS}	60	V
Gate-Source Voltage	V_{GS}	± 20	
Continuous Drain Current ^a	I_D	51	A
Pulsed Drain Current ^b			
Continuous Source Current (Diode Conduction) ^a	I_S	51	A
Power Dissipation ^a	P_D	50	W
Operating Junction and Storage Temperature Range			

THERMAL RESISTANCE RATINGS

Parameter	Symbol	Maximum	Units
Maximum Junction-to-Ambient ^a	$R_{\theta JA}$	40	$^\circ\text{C}/\text{W}$
Maximum Junction-to-Case	$R_{\theta JC}$	3	

Notes

- Surface Mounted on 1" x 1" FR4 Board.
- Pulse width limited by maximum junction temperature

Electrical Characteristics

Parameter	Symbol	Test Conditions	Min	Typ	Max	Unit
Static						
Gate-Source Threshold Voltage	$V_{GS(th)}$	$V_{DS} = V_{GS}, I_D = 250 \mu A$	1			V
Gate-Body Leakage	I_{GSS}	$V_{DS} = 0 V, V_{GS} = \pm 20 V$			± 100	nA
Zero Gate Voltage Drain Current	I_{DSS}	$V_{DS} = 48 V, V_{GS} = 0 V$			1	uA
		$V_{DS} = 48 V, V_{GS} = 0 V, T_J = 55^\circ C$			25	
On-State Drain Current ^a	$I_{D(on)}$	$V_{DS} = 5 V, V_{GS} = 10 V$	35			A
Drain-Source On-Resistance ^a	$r_{DS(on)}$	$V_{GS} = 10 V, I_D = 20 A$			13	m Ω
		$V_{GS} = 4.5 V, I_D = 16 A$			18	
Forward Transconductance ^a	g_{fs}	$V_{DS} = 15 V, I_D = 20 A$		24		S
Diode Forward Voltage ^a	V_{SD}	$I_S = 25.5 A, V_{GS} = 0 V$		0.9		V
Dynamic^b						
Total Gate Charge	Q_g	$V_{DS} = 30 V, V_{GS} = 4.5 V,$ $I_D = 20 A$		20		nC
Gate-Source Charge	Q_{gs}			5.9		
Gate-Drain Charge	Q_{gd}			11		
Turn-On Delay Time	$t_{d(on)}$	$V_{DS} = 30 V, R_L = 1.5 \Omega,$ $I_D = 20 A,$ $V_{GEN} = 10 V, R_{GEN} = 6 \Omega$		10		ns
Rise Time	t_r			11		
Turn-Off Delay Time	$t_{d(off)}$			61		
Fall Time	t_f			19		
Input Capacitance	C_{iss}	$V_{DS} = 15 V, V_{GS} = 0 V, f = 1 MHz$		2022		pF
Output Capacitance	C_{oss}			101		
Reverse Transfer Capacitance	C_{rss}			158		

Notes

- Pulse test: PW \leq 300us duty cycle \leq 2%.
- Guaranteed by design, not subject to production testing.

Analog Power (APL) reserves the right to make changes without further notice to any products herein. APL makes no warranty, representation or guarantee regarding the suitability of its products for any particular purpose, nor does APL assume any liability arising out of the application or use of any product or circuit, and specifically disclaims any and all liability, including without limitation special, consequential or incidental damages. "Typical" parameters which may be provided in APL data sheets and/or specifications can and do vary in different applications and actual performance may vary over time. All operating parameters, including "Typicals" must be validated for each customer application by customer's technical experts. APL does not convey any license under its patent rights nor the rights of others. APL products are not designed, intended, or authorized for use as components in systems intended for surgical implant into the body, or other applications intended to support or sustain life, or for any other application in which the failure of the APL product could create a situation where personal injury or death may occur. Should Buyer purchase or use APL products for any such unintended or unauthorized application, Buyer shall indemnify and hold APL and its officers, employees, subsidiaries, affiliates, and distributors harmless against all claims, costs, damages, and expenses, and reasonable attorney fees arising out of, directly or indirectly, any claim of personal injury or death associated with such unintended or unauthorized use, even if such claim alleges that APL was negligent regarding the design or manufacture of the part. APL is an Equal Opportunity/Affirmative Action Employer.

Typical Electrical Characteristics

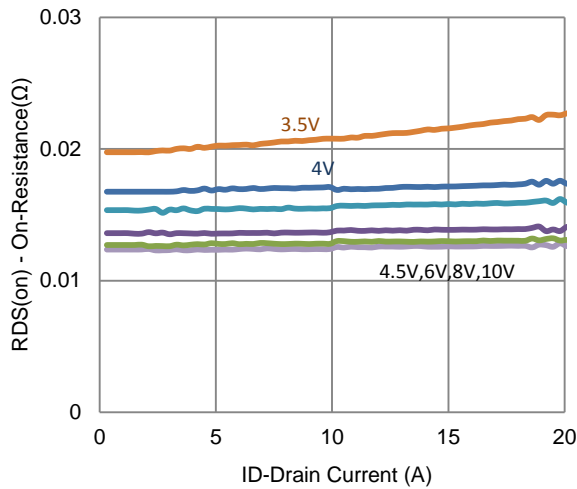

1. On-Resistance vs. Drain Current

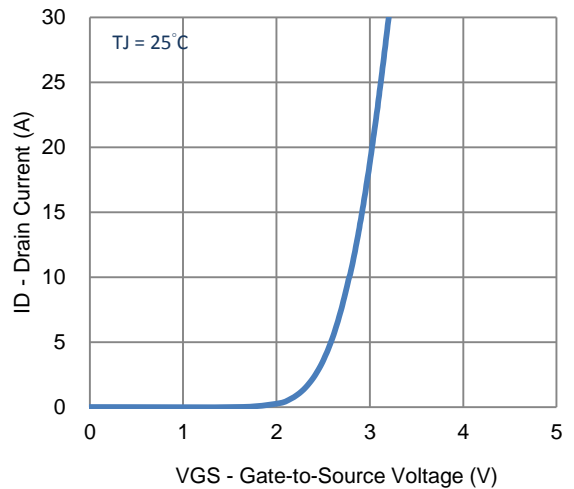

2. Transfer Characteristics

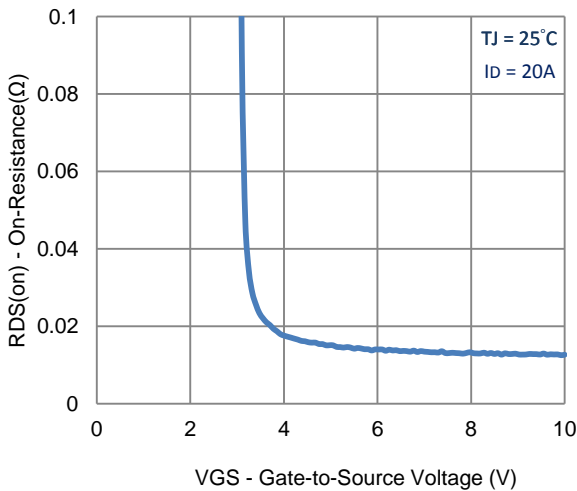

3. On-Resistance vs. Gate-to-Source Voltage

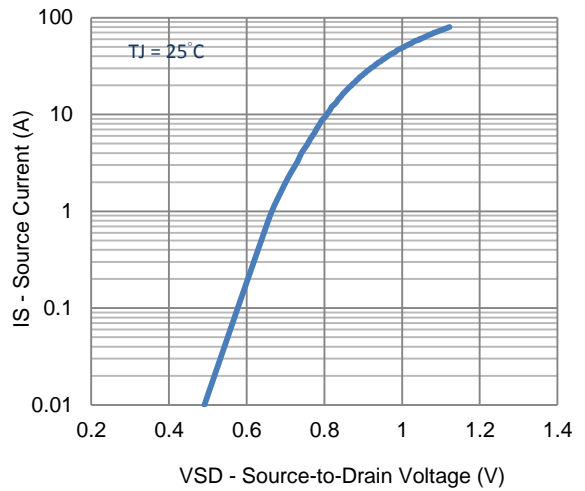

4. Drain-to-Source Forward Voltage

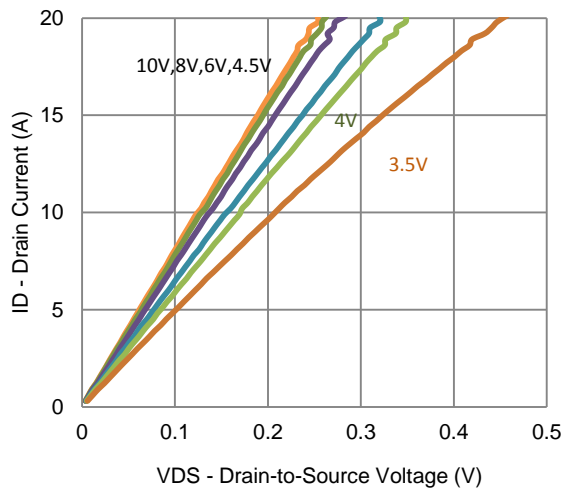

5. Output Characteristics

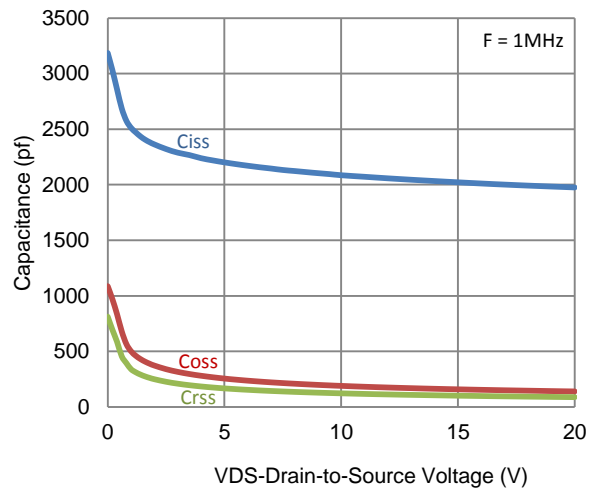

6. Capacitance

Typical Electrical Characteristics

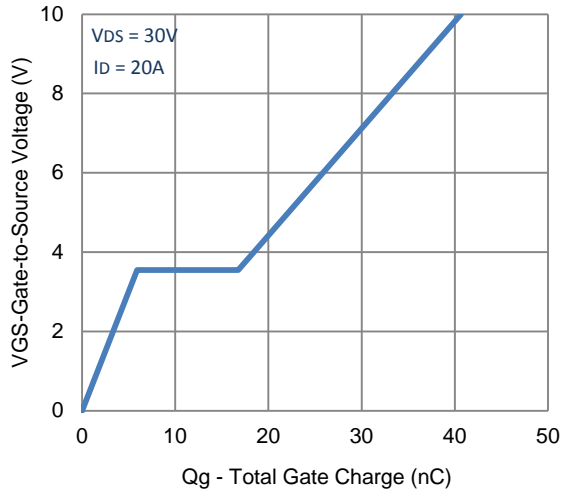

7. Gate Charge

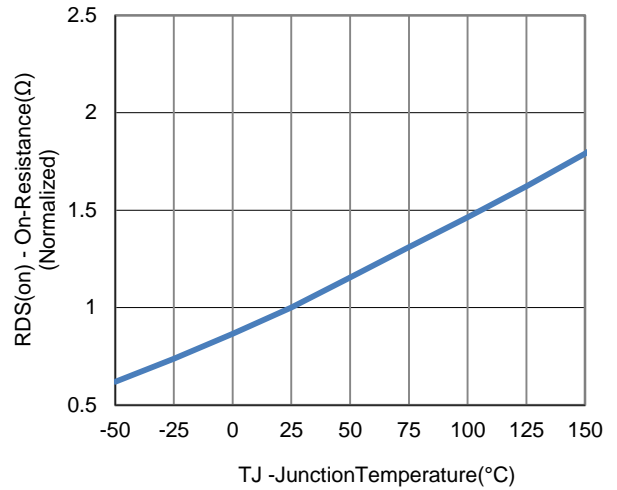

8. Normalized On-Resistance Vs Junction Temperature

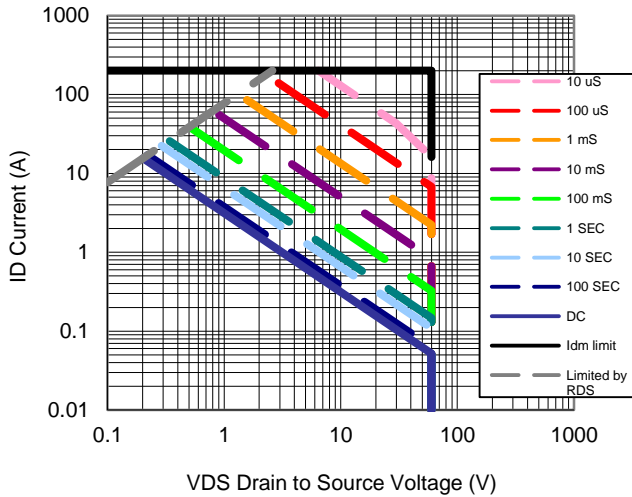

9. Safe Operating Area

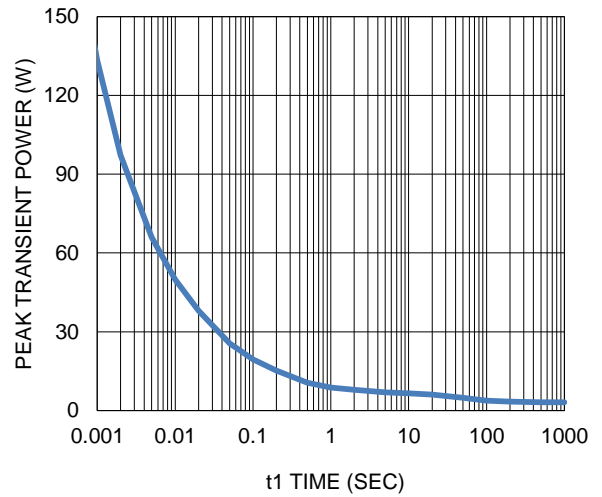

10. Single Pulse Maximum Power Dissipation

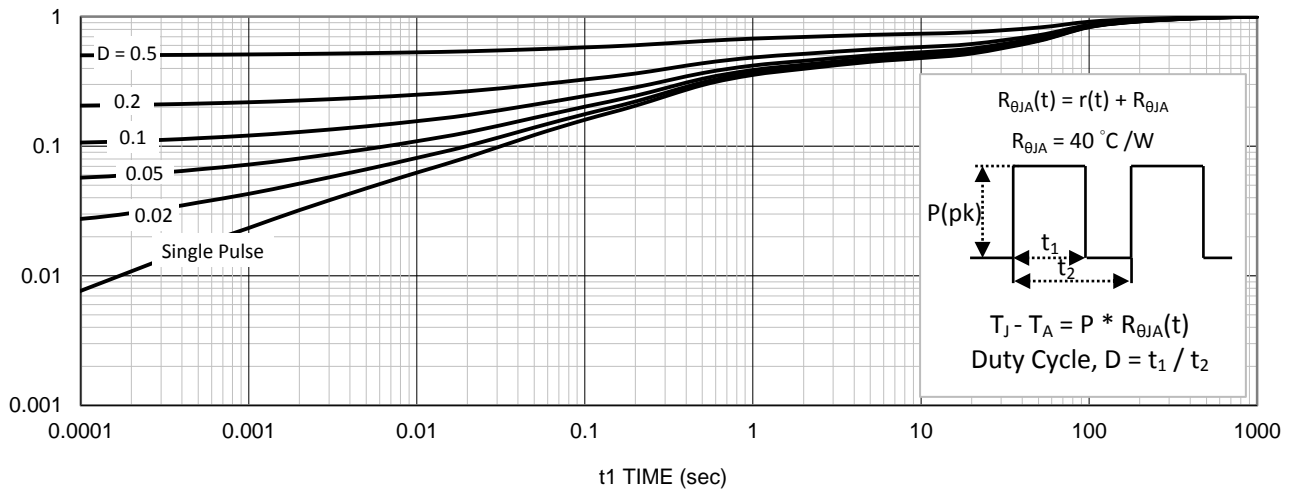

11. Normalized Thermal Transient Junction to Ambient

Package Information

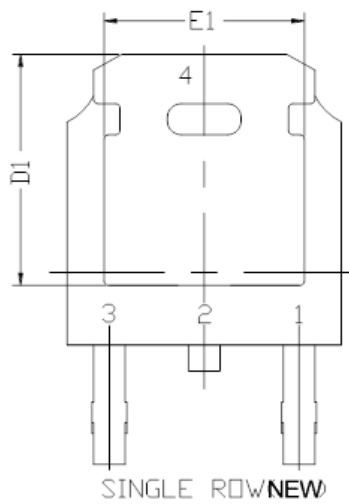
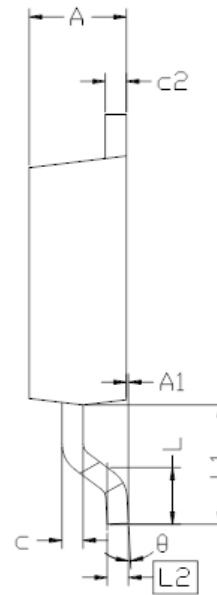
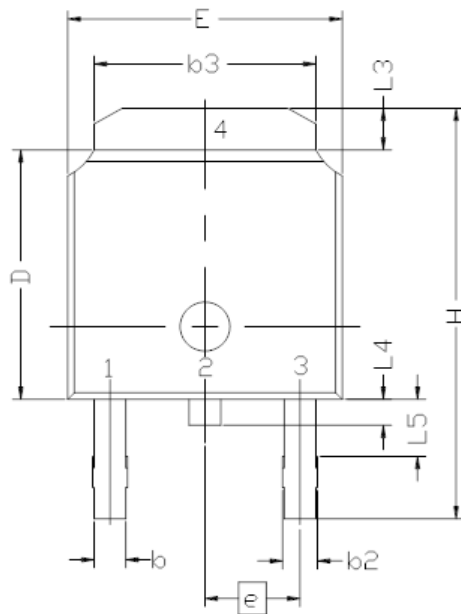

SYMBOL	DIMENSIONAL REQMTS		
	MIN	NOM	MAX
E	6.40	6.60	6.731
L	1.40	1.52	1.77
L1	2.743 REF		
L2	0.508 BSC		
L3	0.89	--	1.27
L4	0.64	--	1.01
L5	--	--	--
D	6.00	6.10	6.223
H	9.40	10.00	10.40
b	0.64	0.76	0.88
b2	0.77	0.84	1.14
b3	5.21	5.34	5.46
e	2.286 BSC		
A	2.20	2.30	2.38
A1	0	--	0.127
c	0.45	0.50	0.60
c2	0.45	0.50	0.58
D1	5.30	--	--
E1	4.40	--	--
θ	0°	--	10°

Note:

1. All Dimension Are In mm.
2. Package Body Sizes Exclude Mold Flash, Protrusion Or Gate Burrs. Mold Flash, Protrusion Or Gate Burrs Shall Not Exceed 0.10 mm Per Side.
3. Package Body Sizes Determined At The Outermost Extremes Of The Plastic Body Exclusive Of Mold Flash, Gate Burrs And Interlead Flash, But Including Any Mismatch Between The Top And Bottom Of The Plastic Body.