

H002 AKH-0.66 II 型电流互感器规格书 V1.0

1. 产品特点

产品翻盖式设计，外形美观，接线方便。翻盖材料选用透明聚碳酸酯，能清楚看到二次引线接线情况。卧式方孔型，可穿越 1~6 根汇流排，亦可穿越多根电缆，一般与电气测量仪表配套使用。

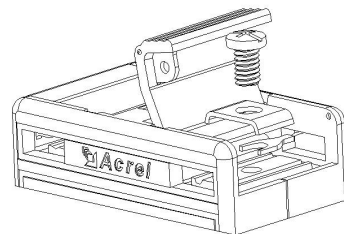

2. 型号说明

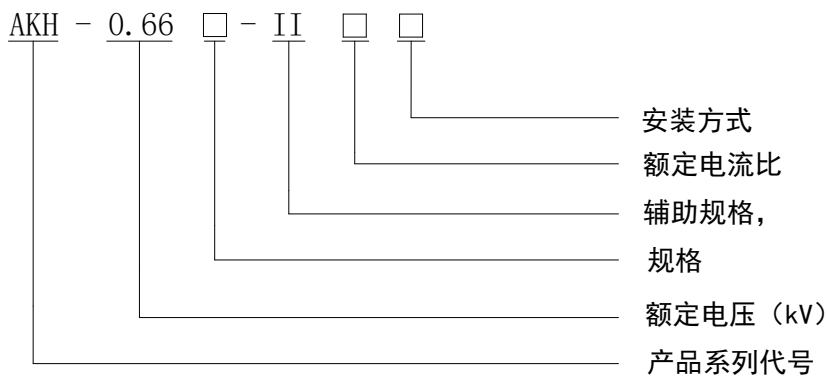

3. 规格尺寸 (单位: mm, 公差: $\pm 1\text{mm}$)

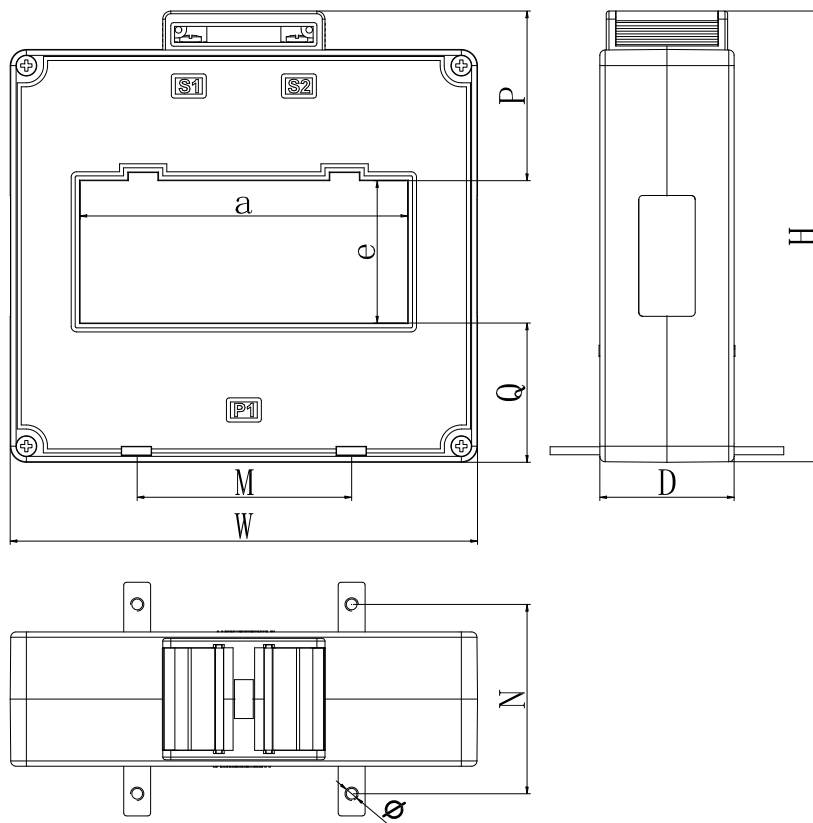

江苏安科瑞电器制造有限公司

电话: 0510-86179960

地址: 江苏省江阴市南闸东盟工业园宏图路 31 号

传 真: 0510-86179835

E-mail: acrelct@email.acrel.cn

规格型式	外形尺寸			穿孔尺寸		安装尺寸					公差
	W	H	D	a	e	M	N	P	Q	Φ	
3011	62	98	45	32	32	28	57.5	36.5	29.5	5	±1
4011	79	103	45	43	31.5	48	57.5	43	28.5	5	
5011	87	113	45	52	32	30	57.5	45	36	5	
6011	102	125	45	61	33	42	57.5	50.5	41.5	5	
60×5011	102	142	45	62	51.5	42	57.5	51.5	39	5	
8011	117	119	45	82	32	60	57.5	48	39	5	
80×5011	120	141	45	82	52	60	57.5	49.5	39.5	5	
10011	145	125	45	103	35	80	57.5	49.5	40.5	5	
100×5011	145	155	50	103	55	80	70.5	57.5	42.5	5	±2
100×8011	152	190	55	104	85	80	70.5	59.5	45.5	5	
120×5011	174	168	50	122	53	80	70.5	63	52	5	
120×8011	160	193	60	122	72	54	70.5	68	53	5	
130×5011	176	160	50	135	55	85	70.5	59.5	45.5	5	
150×5011	210	176	55	155	55	103	70.5	70.5	50.5	5	
180×5011	240	181	60	185	55	40/40/40	83	70.5	55.5	5	
200×5011	247	172	55	205	60	102	83	63	49	5	
220×5011	280	190	60	225	55	65/55/65	83	73.5	61.5	5	
260×5011	320.5	191	60	264.5	54.5	65/55/65	83	75.5	61	5	
170×10011	227	230	60	172	105	103	83	70	55	5	
260×10011	308	226	63	265	103	181	83	69	54	5	

4. 规格参数



规格	额定电流比(A)	准确级及相应额定负荷(VA/Ω)			穿心匝数(匝)	母排规格(mm)/根数	安装方式
		0.2	0.5	1			
3011	100/5(1)			1.5	1	30x10/1-2	A, C
	150/5(1)			1.5	1		
	200/5(1)		2.5		1		
	250/5(1)		3.75		1		
	300-450/5(1)		5		1		

江苏安科瑞电器制造有限公司

电话: 0510-86179960

地址: 江苏省江阴市南闸东盟工业园宏图路 31 号

传 真: 0510-86179835

E-mail: acrelct@email.acrel.cn



	500/5 (1)		10		1		
	600/5		10		1		
40II	100/5 (1)			1.5	1	40×10/ 1-2	A, C
	150/5 (1)			2.5	1		
	200/5 (1)		2.5		1		
	250/5 (1)		3.75		1		
	300-450/5 (1)		5		1		
	500-800/5 (1)		10		1		
	1000/5 (1)	10			1		
50II	150			2.5	1	50×10/ 1-2	A, C
	200-250/5 (1)		2.5		1		
	300-450/5 (1)		5		1		
	500-800/5 (1)		10		1		
	1000-1250/5 (1)	10			1		
	1500/5 (1)	20			1		
60II	200-250/5 (1)		2.5		1	60×10/ 1-2	C
	300-450/5 (1)		5		1		
	500-800/5 (1)		10		1		
	1000-1250/5 (1)	10			1		
	1500-2000/5 (1)	20			1		
	2500/5 (1)	30			1		
60×50II	200-250/5 (1)		2.5		1	60×10/ 1-3	D
	300-450/5 (1)		5		1		
	500-800/5 (1)		10		1		
	1000-1250/5 (1)	10			1		
	1500-2000/5 (1)	20			1		
	2500/5 (1)	30			1		
80II	200-250/5 (1)		2.5		1	80×10/ 1-2	D
	300-450/5 (1)		5		1		
	500-800/5 (1)		10		1		
	1000-1250/5 (1)	10			1		
	1500-2000/5 (1)	20			1		
	2500-3000/5 (1)	30			1		
80×50II	200-250/5 (1)		2.5		1	80×10/ 1-3	D
	300-450/5 (1)		5		1		
	500-800/5 (1)		10		1		
	1000-1250/5 (1)	10			1		
	1500-2000/5 (1)	20			1		
	2500-3000/5 (1)	30			1		
100II	300-450/5 (1)		5		1	100×10/ 1-2	D
	500-800/5 (1)		10		1		
	1000-1250/5 (1)	10			1		
	1500-2000/5 (1)	20			1		





江苏安科瑞电器制造有限公司

电话: 0510-86179960

地址: 江苏省江阴市南闸东盟工业园宏图路 31 号

传 真: 0510-86179835

E-mail: acrelct@email.acrel.cn

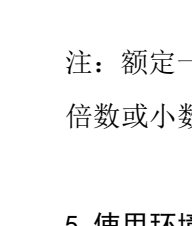
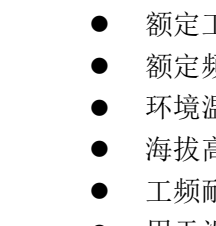
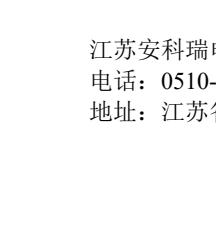
	2500-4000/5 (1)	30			1		
	100×50 II	300-450/5 (1)		5		1	100×10/ 1-3
		500-800/5 (1)		10		1	
		1000-1250/5 (1)	10			1	
		1500-2000/5 (1)	20			1	
		2500-4000/5 (1)	30			1	
	100×80 II	600-800/5 (1)		10		1	100×10/ 1-4
		1000-1250/5 (1)	10			1	
		1500-2000/5 (1)	20			1	
		2500-4000/5 (1)	30			1	
	120×50 II	500-800/5 (1)		10		1	120×10/ 1-3
		1000-1250/5 (1)	10			1	
		1500-2000/5 (1)	20			1	
		2500-5000/5 (1)	30			1	
	130×50 II	600-800/5 (1)		10		1	125×10/1-3 130×10/1-3 60×10/2-6
		1000-1250/5 (1)	10			1	
		1500-2000/5 (1)	20			1	
		2500-5000/5 (1)	30			1	
	120×80 II 150×50 II	1000-1250/5 (1)	10			1	120×10/ 1-4
		1500-2000/5 (1)	20			1	
		2500-5000/5 (1)	30			1	
	170×100 II	1500-2000/5 (1)	15			1	170×10/1-3 100×10/3-6
		2500-5000/5 (1)	30			1	
	180×50 II	1200-2000/5 (1)	10			1	180×10/1-3
		2500-5000/5 (1)	30			1	
	200×50 II 220×50 II 260×50 II	1500-2000/5 (1)	20			1	200×10/1-3 100×10/4-6
		2500-5000/5 (1)	30			1	
		1200-1500/5 (1)	10			1	
260×100 II		1500-2000/5(1)	20			1	250×10/2-5 125× 10/4-10
		2500-6300/5(1)	30			1	

D

注：额定一次电流的标准值为：10A、12.5A、15A、20A、25A、30A、40A、50A、60A、75A 以及它们十进位倍数或小数，有下标线的是优先值。

5. 使用环境

- 额定工作电压 AC0.66kV（等效 AC0.69kV，GB156-2017）
- 额定频率 50-60Hz
- 环境温度-30℃~70℃
- 海拔高度≤3000m
- 工频耐压 3000V/1min 50Hz
- 用于没有雨雪直接侵袭，无严重污染及剧烈震动的场所

江苏安科瑞电器制造有限公司

电话：0510-86179960

地址：江苏省江阴市南闸东盟工业园宏图路 31 号

传 真：0510-86179835

E-mail: acrelct@email.acrel.cn

6. 安装示意图

A 型安装:

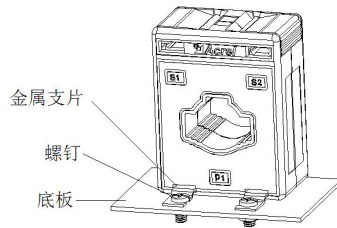

A. 直片固定

C 型安装:

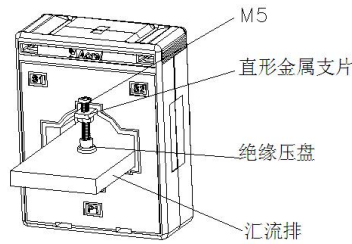

C. 单片压盘固定

D 型安装:

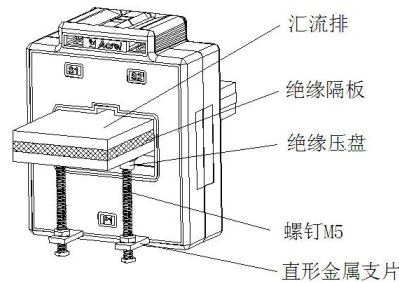
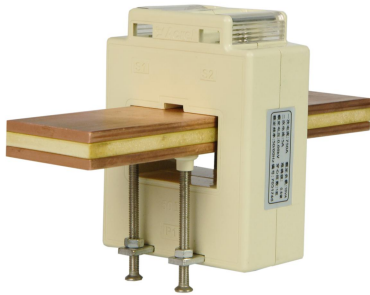

D. 双片压盘固定

7. 成品检验项目

序号	名称	测试条件	标准测试仪器	产品检定周期	产品检定依据
1	外观、端子标志	温度 20-25℃ 湿度 50-65%	HLS-50G2 标准电流互感器、 HES-1 数字式互感器校验仪 FY47 电流互感器负载箱 FY49 电流互感器负载箱、 LK2673 耐压测试仪 ZC25-4 绝缘电阻摇表、 HKY-9908 电流互感器开路测试仪	2 年	GB 20840.2-2014 《电流互感器》 JJG313-2010 检定规程
2	工频耐压				
3	绝缘电阻				
4	误差试验				
5	开路试验				

注：电流互感器使用时，二次不得开路，二次出线 S2 需接地！

江苏安科瑞电器制造有限公司

电话：0510-86179960

地址：江苏省江阴市南闸东盟工业园宏图路 31 号

传 真：0510-86179835

E-mail: acrelct@email.acrel.cn