

# C15M

## Single Loop Controller

### User's Manual

### "Installation"

Thank you for purchasing the C15M.  
Before operating this product described in this User's Manual, please take note of the following points regarding safety. Be sure to keep this manual nearby for handy reference.

Please read the "Terms and Conditions" from the following URL before ordering or use:  
<http://www.azbil.com/products/bi/order.html>

#### NOTICE

Be sure that the user receives this manual before the product is used.

Copying or duplicating this user's manual in part or in whole is forbidden. The information and specifications in this manual are subject to change without notice.

Considerable effort has been made to ensure that this manual is free from inaccuracies and omissions. If you should find an error or omission, please contact Azbil Corporation.

In no event is Azbil Corporation liable to anyone for any indirect, special or consequential damages as a result of using this product.

© 2006-2015 Azbil Corporation All Rights Reserved.

This manual explains handling precautions, mounting, wiring procedures, PV range types, parameter list and main specifications only.

#### Unpacking

Check the following items when removing the C15MT from its package:





Name	Part No.	Qty	Remarks
Mounting Bracket	81409651-001	1	
Gasket	81409657-001	1	
User's Manual	CP-UM-5410EC	1	This Manual

#### SAFETY PRECAUTIONS











 **WARNING** Warnings are indicated when mishandling this product might result in death or serious injury to the user.

 **CAUTION** Cautions are indicated when mishandling this product might result in minor injury to the user, or only physical damage to this product.

#### WARNING

-  Note that incorrect wiring of the C15M can damage the C15M and lead to other hazards. Check that the C15M has been correctly wired before turning the power ON.
-  Before wiring, or removing/mounting the C15M, be sure to turn the power OFF. Failure to do so might cause electric shock.
-  Do not touch electrically charged parts such as the power terminals. Doing so might cause electric shock.
-  Do not disassemble the C15M. Doing so might cause electric shock or faulty operation.

#### CAUTION

-  Use the C15M within the operating ranges recommended in the specifications (temperature, humidity, voltage, vibration, shock, mounting direction, atmosphere, etc.). Failure to do so might cause fire or faulty operation.
-  Do not block ventilation holes. Doing so might cause fire or faulty operation.
-  Wire the C15M properly according to predetermined standards. Also wire the C15M using specified power leads according to recognized installation methods. Failure to do so might cause electric shock, fire or faulty operation.
-  Do not allow lead clippings, chips or water to enter the controller case. Doing so might cause fire or faulty operation.
-  Firmly tighten the terminal screws at the torque listed in the specifications. Insufficient tightening of terminal screws might cause electric shock or fire.
-  Do not use unused terminals on the C15M as relay terminals. Doing so might cause electric shock, fire or faulty operation.
-  We recommend attaching the terminal cover (sold separately) after wiring the C15M. Failure to do so might cause electric shock, fire or faulty operation.
-  Use the relays within the recommended service life. Continuous use might cause fire or faulty operation.
-  If there is a risk of a power surge caused by lightning, use a surge absorber (surge protector) to prevent fire or device failure.
-  Do not operate the keys with a propelling pencil or sharp-tipped object. Doing so might cause faulty operation.

#### Mounting

##### ■ Location

Install the controller in the following locations:

- Common mode voltages for I/O excluding the power supply and relay contact output: The voltage to ground is 30Vr.m.s max., 42.4V peak max., and 60Vdc max.
- Not high or low temperature / humidity.
- Free from silicone gas and other corrosive gases such as sulfide gas.
- Less dust or soot.
- Appropriately processed locations to prevent direct sunlight, wind or rain.
- Less mechanical vibration and shock.
- Not close to the high voltage line, welding machine or electrical noise generating source.
- The minimum 15 meters away from the high voltage ignition device for a boiler.
- Less effect by the magnetic.
- No flammable liquid or gas.
- Indoors.

##### ■ Mounting Procedure

- The mounting must be horizontal within 10 degrees tilted in back side lowering or within 10 degrees tilted in back side rising.
- In the case of panel mount type (C15MT), the mounting panel should be used with a thickness of less than 9 mm of firm board.

## External Dimensions

### C15MT (Panel Mount Type)

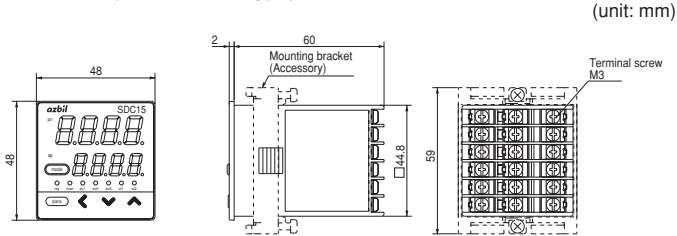

### Handling Precautions

- To fasten this controller onto the panel, tighten a mounting bracket screws, and turn one more half turn when there is no play between the bracket and panel. Excessively tightening the screws may deform the controller case.

### Panel Cutout Dimensions

#### Stand-alone mounting

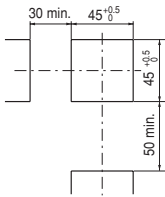

#### Gang-mounting

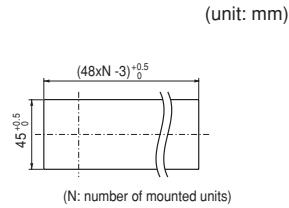

### Handling Precautions

- When three or more units are gang-mounted horizontally, the maximum allowable ambient temperature is 40°C.
- If dustproof or waterproof protection is required, mount the device using the stand-alone mounting method. If gang-mounted, dustproof and waterproof protection may not be maintained.
- Provide a space of at least 50mm or more above and below the controller.

## Wiring

Be sure to provide a switch within operator reach for shutting OFF the main power supply to the controller in the main supply wiring. Also, in case of AC power supply models, the main supply wiring also requires a time-lagged type (T) fuse (rated current: 0.2A, rated voltage: 250 V). (IEC127)

The following table shows the meaning of the symbols in the terminal wiring label on the controller side:

Symbols	Meaning
~	AC power supply
⚠	Caution, fear of electric shock
⚠	Caution

### Handling Precautions

- Before wiring the C15M, verify the controller's model No. and terminal Nos. written on the label on the side of the body. Inspect all wiring once wiring work for the C15M has been completed.
- Provide a distance of at least 50cm between I/O lead wires or communications lead wires and power lead wires of 100V min. Also, do not pass these lead wires through the same piping or wiring duct.
- Be careful not to allow any crimp terminal lugs to touch adjacent terminals.
- To connect 2 (max.) crimp terminals to the same terminal screw, bend the crimp terminals beforehand.
- Connect wires to terminals 1 - 6 and 13 - 18 from the left (when viewing the terminal block).
- Use crimp terminals compatible with M3 terminal screws, as shown in the diagram.  
A: 5.8mm max. B: 5.5 to 7.6mm
- When the power to this controller is turned off, the current input circuit is cut off. If you connect two or more current-input type controllers in series, change the current input to voltage input by connecting a resistor (No. 81401325, sold separately).
- Prepare a heater current conductor to send a heater current through the current transformer. Do not use a heater current that exceeds the specified permissible current as this may damage the controller.

- The controller requires about 6 seconds to start up once the power is turned ON. The controller can be used once it has started up. However, it is recommended to allow a warm-up time of at least 30 minutes to attain the specified accuracy.
- The current transformer input cannot be used for phase control.
- There is no isolation provided between control output 1 and control output 2. Install an isolator as required.
- Do not connect a terminating resistor to either end of the RS-485 communications line. Doing so may interfere with communication.
- Make sure that devices and equipment connected to this device have reinforced insulation suitable for the maximum operating voltage of this device's power supply and input/output ports.

### Connection of C15MT

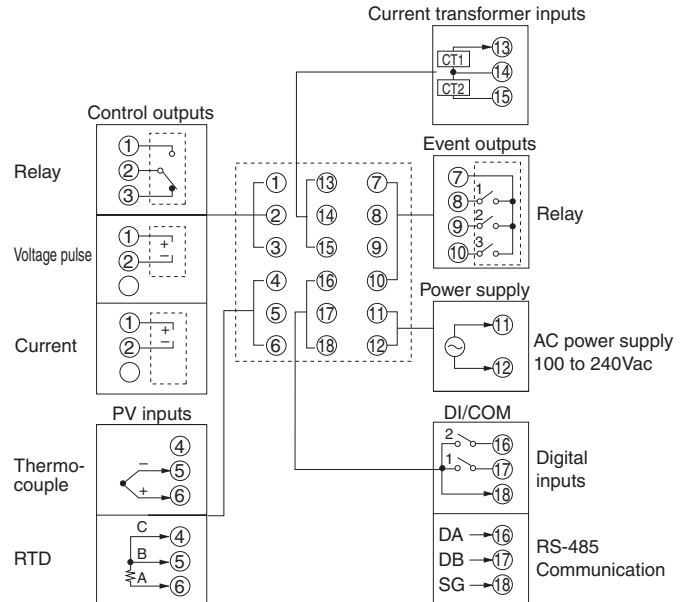

### I/O isolation

Items surrounded by solid lines are insulated from other signals.

Availability of input or output is based on a model number.

Power supply	Internal Circuit	Control output 1
PV input		Control output 2
Current Transformer input 1		Event output 1
Current Transformer input 2		Event output 2
Loader communication		Event output 3
Digital input 1		
Digital input 2		
RS-485 Communication		

## Part names and functions

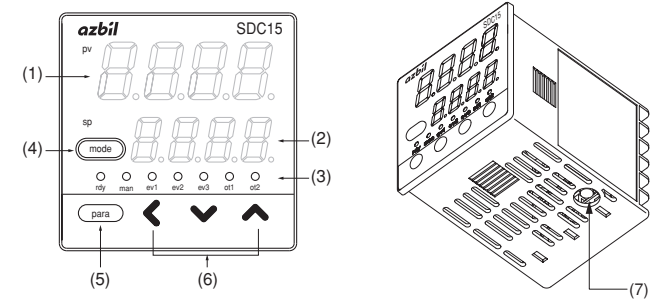

- (1) Upper display: Displays PV values (current temperature, etc.) or setup items.
- (2) Lower display: Displays SP values (set temperature, etc.) and other values of setup items.
- (3) Mode indicator rdy: Lights when READY (control stop)  
 man: Lights when MANUAL (manual mode)  
 ev1 to ev3: Lights when event relays are ON.  
 ot1 to ot2: Lights when the control output is ON.
- (4) Mode key: The operation which was set beforehand can be done by pressing the key for 1s or more.
- (5) Para key: Switches the display.
- (6) <, v, ^ keys: Used for incrementing numeric values and performing arithmetic shift operations.
- (7) Loader connector: Connects to a personal computer with the special cable provided in the smart loader package.

## Key Operation and Setting

The following shows the flow of the key operation. Various displays and settings can be called up to the console:

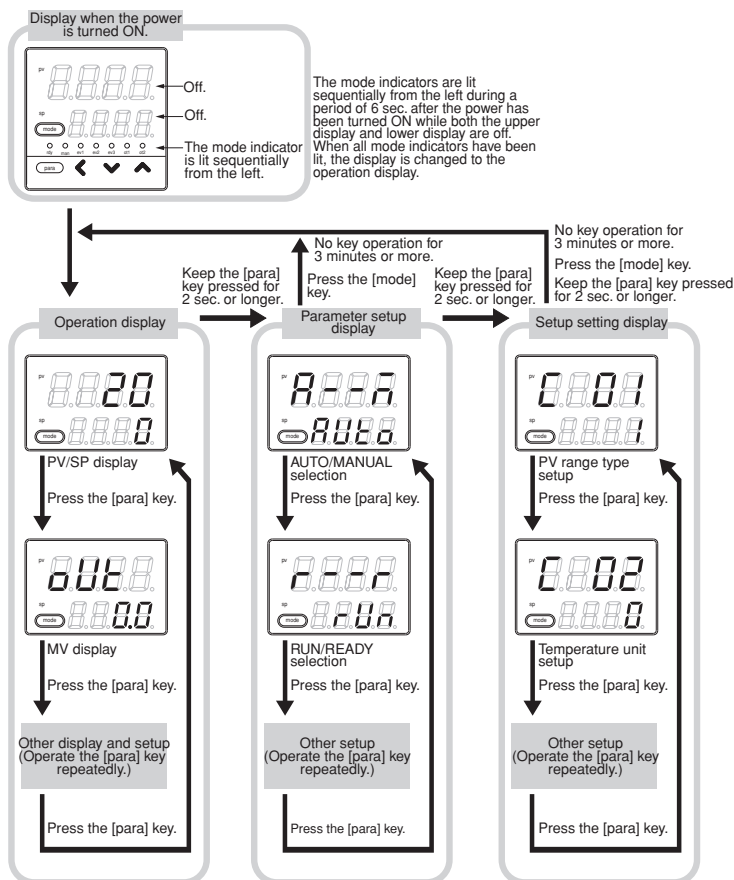

The display and setup status shown above are examples for explanation. Therefore, some displays or settings are not shown actually according to the model and/or setup contents.

### ● PV Input range setup

In the setup setting display mode [C01], press the [<] • [v] • [^] key to set the lower display to select a desired PV range type.

>> When no keys are pressed for 2 sec. or longer, the flashing of the numeric value is stopped to set the currently displayed value.

### ● SP setup

While the PV/SP is displayed in the operation display mode, press the [<] • [v] • [^] key to change the SP in the lower display.

>> When no keys are pressed for 2 sec. or longer, the flashing of the numeric value is stopped to set the currently displayed value.

SP can be set in the parameter setting display mode.

## PV range table

C01 No.	Sensor type	Range[°C]	Range[°F]	C01 No.	Sensor type	Range[°C]	Range[°F]
1	K	-200 to +1200	-300 to +2200	41	Pt100	-200 to +500	-300 to +900
2	K	0 to 1200	0 to 2200	42	JPt100	-200 to +500	-300 to +900
3	K	0.0 to 800.0	0 to 1500	43	Pt100	-200 to +200	-300 to +400
4	K	0.0 to 600.0	0 to 1100	44	JPt100	-200 to +200	-300 to +400
5	K	0.0 to 400.0	0 to 700	45	Pt100	-100 to +300	-150 to +500
6	K	-200.0 to +400.0	-300 to +700	46	JPt100	-100 to +300	-150 to +500
9	J	0.0 to 800.0	0 to 1500	51	Pt100	-50.0 to +200.0	-50 to +400
10	J	0.0 to 600.0	0 to 1100	52	JPt100	-50.0 to +200.0	-50 to +400
11	J	-200.0 to +400.0	-300 to +700	53	Pt100	-50.0 to +100.0	-50 to +200
13	E	0.0 to 600.0	0 to 1100	54	JPt100	-50.0 to +100.0	-50 to +200
14	T	-200.0 to +400.0	-300 to +700	63	Pt100	0 to 200.0	0 to 400
15	R	0 to 1600	0 to 3000	64	JPt100	0 to 200.0	0 to 400
16	S	0 to 1600	0 to 3000	67	Pt100	0 to 500	0 to 900
17	B	0 to 1800	0 to 3300	68	JPt100	0 to 500	0 to 900
18	N	0 to 1300	0 to 2300				
19	PLII	0 to 1300	0 to 2300				
20	WRRe5-26	0 to 1400	0 to 2400				
21	WRRe5-26	0 to 2300	0 to 4200				
24	DIN U	-200.0 to +400.0	-300 to +700				
25	DIN L	-100.0 to +800.0	-150 to +1500				

C01 No.	Input type	Range
84	0 to 1V	The scaling and decimal point position can be changed variably in a range of -1999 to +9999
86	1 to 5V	
87	0 to 5V	
88	0 to 10V	
89	0 to 20mA	
90	4 to 20mA	

### ! Handling Precautions

- The accuracy of the B thermocouple is  $\pm 5\%$ FS for a range of 260°C or less, and  $\pm 1\%$ FS for 260 to 800°C.
- The accuracy of the PLII thermocouple(C01 No.19) in the range of 0 to 32°F does not meet the indication accuracy specified in the Specifications.
- For ranges with a decimal point, tenths are displayed on the line underneath point.
- Make sure to set the correct number in setup display C01, according to the type and range of the sensor used. If the setting is wrong, problems such as large temperature errors in the output may occur.

## Alarm code table

Alarm code	Error	Cause	Countermeasure
AL01	PV input error (over range)	Sensor line break, incorrect wiring, incorrect range code setting	Checking wiring or reset range code.
AL02	PV input error (under range)	Sensor line break, incorrect wiring, incorrect range code setting	Checking wiring.
AL03	CJ failure	Terminal temperature compensation unit failure (thermocouple)	Checking the allowable ambient temperature.
	PV input error	Sensor line break, incorrect wiring (RTD)	Checking wiring.
AL11	CT input failure (over-range) (CT input 1 or 2, or both)	A current exceeding the upper limit of the display range was measured. The number of CT turns or the number of CT power wire loops is incorrectly set, or wiring is incorrect.	<ul style="list-style-type: none"> <li>Use a CT with the correct number of turns for the display range.</li> <li>Reset the number of CT turns.</li> <li>Reset the number of CT power wire loops.</li> <li>Check the wiring.</li> </ul>
AL70	A/D conversion error	Defective A/D converter	Replace unit.
AL95	Parameter error	<ul style="list-style-type: none"> <li>Power turned OFF during fixing of data</li> <li>Data corrupted due to noise, etc.</li> </ul>	Reset data or replace unit.
AL96	Adjustment data error	<ul style="list-style-type: none"> <li>Power turned OFF during fixing of data</li> <li>Data corrupted due to noise, etc.</li> </ul>	
AL97	Parameter error (RAM area)	Data corrupted due to noise, etc.	
AL98	Adjustment data error (RAM area)	Data corrupted due to noise, etc.	
AL99	ROM error	Data corrupted due to noise, etc.	Replace unit.

## Maintenance

- Cleaning:** When wiping out the C15M, use the soft and dried cloth.
- Parts replacement:** Do not replace the parts.
- Fuse replacement:** When replacing the fuse for the power supply wires, make sure that the replacement fuse complies with all applicable safety standards.  
Standard IEC127, Cutoff Speed Delayed operation type (T),  
Rated Voltage 250V, Rated Current 0.2A

## Model selection table

Basic model No.	Mounting	Control output	PV input	Power supply	Optional functions	Additional processing	Specifications		
C15M	T						Panel mount type		
							Control output 1	Control output 2	
							Relay output (NO)	Relay output (NC)	
							Voltage pulse output (for SSR drive)	None	
							C0	Current output	None
							T	Thermocouple input (K, J, E, T, R, S, B, N, PLII, WR5-26, DINU, DINL)	
							R	RTD input (Pt100/JPt 100)	
							L	DC voltage /DC current input (0 to 1Vdc, 1 to 5Vdc, 0 to 5Vdc, 0 to 10Vdc, 0 to 20mAdc, 4 to 20mAdc)	
							A	AC Model (100 to 240Vac)	
							01	Event relay output: 3 points	
							02	Event relay output: 3 points Current transformer input: 2 points Digital input: 2 points	
							03	Event relay output: 3 points Current transformer input: 2 points RS-485 communication	
							00	Chinese (Simplified)	
							01	Chinese (Traditional)	

## Specifications

- PV input**
  - Thermocouple: K,J,E,T,R,S,B,N (JIS C1602-1995)  
PL II (Engelhard Industries Data (ITS90))  
WR5-26 (ASTM E988-96(Reapproved 2002))  
DIN U,DIN L (DIN 43710-1985)
  - Resistance temperature detector (RTD): Pt100 (JIS C1604-1997)  
JPt100 (JIS C1604-1989)
  - DC voltage: 0 to 1V, 1 to 5V, 0 to 5V, 0 to 10V
  - DC current: 0 to 20mA, 4 to 20mA
  - Sampling cycle: 500ms
  - Accuracy:  $\pm 0.5\%FS \pm 1$  digit,  
 $\pm 1\%FS \pm 1$  digit for a negative area of the thermocouple (at ambient temperature  $23 \pm 3^\circ C$ )
  - Allowable input:
    - 0.5 V to +12 V (thermocouple, RTD, DC, voltage)
    - 30 mA max or 4 V max (DC current)
    - More than the allowable input voltage or current may damage this device.
- Digital input**
  - Input type: Dry contact or open collector
  - Allowable ON contact resistance: Max.250 $\Omega$
  - Allowable OFF contact resistance: Min.100k $\Omega$
  - Allowable ON voltage: Max.1.0V
  - Terminal current (ON): Approx.7.5mA in case of short circuit  
Approx.5.0mA in case of contact resistance 250 $\Omega$
  - Minimum hold time: 1s or more
- Current transformer input**
  - Number of input points: 2 points
  - Input object: Current transformer with 100 to 4,000 turns (availability is by 100-turn units)  
Optional unit Model No.: QN206A (800 turns, hole diameter: 5.8 mm)  
Optional unit Model No.: QN212A (800 turns, hole diameter: 12mm)
  - Current measurement lower limit: 0.4Aac (800 turns, 1 time)  
Formula; Number of turns  $\div$  (2000 x number of power wire loops)
  - Current measurement upper limit: 50.0Aac (800 turns, 1 time)  
Formula; Number of turns  $\div$  (16 x number of power wire loops)
  - Allowable measured current: 70.0Aac (800 turns, 1 time)  
Formula; Number of turns  $\div$  (16 x number of power wire loops) x 1.4
  - Display range lower limit: 0.0Aac

- Display range upper limit: 70.0Aac (800 turns, 1 time)  
Formula; Number of turns  $\div$  (16 x number of power wire loops) x 1.4
- Display accuracy:  $\pm 5\%FS$
- Display resolution: 0.1Aac

- Control output**
  - Relay output
    - Contact rating: NO side 250Vac/30Vdc, 3A (resistive load)  
NC side 250Vac/30Vdc, 1A (resistive load)  
NO side Min. 50,000 operations  
NC side Min. 100,000 operations
    - Life:
      - Min. switching specifications: 5V, 100mA
      - Min. ON time / OFF time: 250ms
  - Voltage pulse output (for SSR drive)
    - Open circuit voltage: 19Vdc $\pm 15\%$
    - Internal resistance: 82 $\Omega \pm 0.5\%$
    - Allowable current: Max. 24mAdc (a higher current might cause output circuit failure)
    - Min. OFF time / ON time: 1ms (Time proportional cycle time < 10s)  
250ms (Time proportional cycle time  $\geq 10s$ )
- Current output**
  - Output type: 0 to 20mAdc or 4 to 20mAdc current output
  - Allowable load resistance: Max.600 $\Omega$
  - Output accuracy:  $\pm 0.5\%FS$  (at ambient temperature  $23 \pm 3^\circ C$ )  
 $\pm 1\%FS$  at 0 to 1mA
- Event relay outputs (ev1 to 3)**
  - Contact rating: 250Vac/30Vdc 2A (resistive load)
  - Life: Min. 100,000 operations
  - Min. switching specification: 5V, 10mA (Reference value)
- RS-485 communication**
  - Transmission line: 3-wire system
  - Transmission speed: 4800, 9600, 19200, 38400bps
  - Communication protocol: CPL and MODBUS conforming
  - Terminating resistor: Do not connect a terminating resistor.
- Environmental condition**
  - Operating conditions
    - Ambient temperature: 0 to 50 $^\circ C$  (Gang-mounting: 0 to 40 $^\circ C$ )
    - Ambient humidity: 10 to 90%RH (Without condensation)
    - Power supply voltage: AC Model  
85 to 264Vac, 50/60Hz $\pm 2Hz$   
(Rated power voltage 100 to 240Vac 50/60Hz)
- Transport conditions**
  - Ambient temperature: -20 to +70 $^\circ C$
  - Ambient humidity: 10 to 95%RH (Without condensation)

- Other specifications**
  - Degrees of protection: Case front side IP66 /NEMA 4 equivalent (Only for stand-alone mounting on a panel when an attached gasket is used.)
  - Power consumption: AC Model  
Max. 12VA (100Vac:8VA, 264Vac:12VA)  
(6VA for 100Vac and 9VA for 264Vac to our company SDC10 equivalent function)
  - Non-detected power failure time: Max. 20ms (AC model)
  - Altitude: Max. 2000m
  - Mass: Approx.150g (with mounting bracket) at panel mount type
  - Terminal screw tightening torque: 0.4 to 0.6N·m
  - Applicable standards: EN61010-1,  
EN61326-1 (For use in industrial locations)  
During EMC testing, the reading or output may fluctuate by  $\pm 10\%$  FS.
  - Over-voltage category: Category II (IEC60364-4-443, IEC60664-1)
  - Allowable pollution degree: Pollution degree 2
  - Recommended cables: For thermocouples:  
Connect thermocouple wires to the terminals directly. When a thermocouple is connected to terminal block, or wiring distance is long, connect the wire via a shielded compensating lead wire.  
For input/output other than thermocouples:  
Use a JCS 4364 instrument cable or equivalent. If electromagnetic induction noise is comparatively low, a shielded multiconductor microphone cord (MVVS) may be used.

## Accessories and optional parts

Name	Model No.
Mounting bracket (for C15MT)	81409651-001 (Accessory)
Gasket (for C15MT)	81409657-001 (Accessory)
Current transformer	QN206A (5.8mm hole dia.)
	QN212A (12mm hole dia.)
Hard cover	81446442-001
Soft cover	81446443-001
Terminal cover	81446898-001

# C15M List of Parameters

User level details 0: Display in basic / standard / high function,  
1: Display in standard / high function,  
2: Display in high function.  
Initial value may vary depending on model No.

## [List of Operation Displays]

### ■ Operation Displays

Display	Item	Contents	Initial value	User level
Upper display: PV Lower display: SP	SP (Target value)	SP low limit (C07) to SP high limit (C08)	0	0
Upper display: LSP Lower display: LSP	LSP No. (1st digit: Value at the right end digit)	1 to LSP system group (C30 Max. 4)	1	0
Upper display: MV	MV (Manipulated Variable)	-10.0 to +110.0% Setting is disabled in AUTO mode. (Numeric value does not flash.) Setting is enabled in MANUAL mode. (Numeric value flashes.)	-	0
Upper display: HEAT	Heat MV (Manipulated Variable)	Setting is disabled -10.0 to +110.0%	-	0
Upper display: COOL	Cool MV (Manipulated Variable)	Setting is disabled. Except for 0: During execution of AT (Value is decreased.) 0: Completion of AT	-	0
Upper display: PV Example: AT progress display (1st digit = Numeric value at right end digit)	AT progress display (1st digit = Numeric value at right end digit)	Setting is disabled.	-	0
Upper display: CT1	CT (Current transformer) current value 1	Setting is disabled.	-	0
Upper display: CT2	CT (Current transformer) current value 2	Setting is disabled.	-	0
Upper display: E1	Internal event 1 main setting	Setting range is different depending on the internal event operation type. -1999 to +9999U: Except below. 0 to 9999U: When the setting value is an absolute value. -199.9 to +999.9%: For MV.	0	0
Upper display: E1.5b	Internal event 1 sub-setting	Setting is disabled.	0	0
Upper display: E1...	Timer remaining time 1	Setting is disabled. Upper display: The distinction by ON delay or OFF delay is displayed at the side location of [1.]. Lower display: Displayed by the unit (either one of 0.1s, s, or min) based on the internal event 1 delay time unit (E1, the 3rd digit of C3).	-	0
Upper display: E2	Internal event 2 main setting	Setting range is different depending on the internal event operation type. -1999 to +9999U: Except below. 0 to 9999U: When the setting value is an absolute value. -199.9 to +999.9%: For MV.	0	0
Upper display: E2.5b	Internal event 2 sub-setting	Setting is disabled.	0	0
Upper display: E2...	Timer remaining time 2	Setting is disabled. Upper display: The distinction by ON delay or OFF delay is displayed at the side location of [2.]. Lower display: Displayed by the unit (either one of 0.1s, s, or min) based on the internal event 2 delay time unit (E2, the 3rd digit of C3).	-	0
Upper display: E3	Internal event 3 main setting	Setting range is different depending on the internal event operation type. -1999 to +9999U: Except below. 0 to 9999U: When the setting value is an absolute value. -199.9 to +999.9%: For MV.	0	0
Upper display: E3.5b	Internal event 3 sub-setting	Setting is disabled.	0	0
Upper display: E3...	Timer remaining time 3	Setting is disabled. Upper display: The distinction by ON delay or OFF delay is displayed at the side location of [3.]. Lower display: Displayed by the unit (either one of 0.1s, s, or min) based on the internal event 3 delay time unit (E3, the 3rd digit of C3).	-	0

### ■ PID bank

#### Bank selection: P12

Display	Item	Contents	Initial value	User level
P-1	Proportional band	0.1 to 999.9%	5.0	0
I-1	Integration time	0 to 9999s (0: No integral control action)	120	0
D-1	Derivative time	0 to 9999s (0: No derivative control action)	30	0
RE-1	Manual reset	-10.0 to +110.0%	50.0	0
OL-1	MV low limit	-10.0 to +110.0%	0.0	1
OH-1	MV high limit	-10.0 to +110.0%	100.0	1
P-1C	Cool-side proportional band	0.1 to 999.9%	5.0	0
I-1C	Cool-side integration time	0 to 9999s (0: No integral control action)	120	0
D-1C	Cool-side derivative time	0 to 9999s (0: No derivative control action)	30	0
OL-1C	Cool-side MV low limit	-10.0 to +110.0%	0.0	1
OH-1C	Cool-side MV high limit	-10.0 to +110.0%	100.0	1

### ■ Parameter bank

#### Bank selection: PRRR

Display	Item	Contents	Initial value	User level
CR-1	Control method	0: ON/OFF control 1: PID fixed 2: ST (Self turning)	0 or 1	0
HE, OL	MV low limit at AT	-10.0 to +110.0%	0.0	0
HE, OH	MV high limit at AT	-10.0 to +110.0%	100.0	0
DIFF	ON/OFF control differential	0 to 9999U	5	0
OFFS	ON/OFF control operating point differential	-1999 to +9999U	0	2
FL	PV filter	0.0 to 120.0s	0.0	0
RR	PV ratio	0.001 to 9.999	1.000	1
BI	PV bias	-1999 to +9999U	0	0
CPU	Time proportional cycle unit 1	0: 1s unit 1: 0.5s fixed (Cycle time is disabled.) 2: 0.2s fixed (Cycle time is disabled.) 3: 0.1s fixed (Cycle time is disabled.)	0	2
CP1	Time proportional cycle 1	5 to 120s (The output includes the relay output.) 1 to 120s (The output does not include the relay output.)	10 or 2	0
CPU2	Time proportional cycle unit 2	0: 1s unit 1: 0.5s fixed (Cycle time is disabled.) 2: 0.2s fixed (Cycle time is disabled.) 3: 0.1s fixed (Cycle time is disabled.)	0	2
CP2	Time proportional cycle 2	5 to 120s (The output includes the relay output.) 1 to 120s (The output does not include the relay output.)	10 or 2	0
EP, EP	Time proportional operation type	0: Controllability aiming type 1: Actuator life aiming type (Only one ON/OFF operation within time proportional cycle time)	0 or 1	2
SPU	SP ramp-up	0.0 to 999.9U (0.0: No ramp)	0.0	2
SPD	SP ramp-down	0.0 to 999.9U (0.0: No ramp)	0.0	2

### ■ Extension tuning bank

#### Bank selection: E1

Display	Item	Contents	Initial value	User level
RE, EY	AT type	0: Normal (Standard control characteristics) 1: Immediate response (Control characteristics immediately responding to the external disturbance.) 2: Stable (Control characteristics with less up/down function of PV)	1	0
UF, SD	Just-FITTER setting band	0.00 to 10.00	0.30	2
SP, LS	SP lag constant	0.0 to 999.9	0.0	2
RE-P	Proportional band tuning factor at AT	0.00 to 99.99	1.00	2
RE-I	Integration time tuning factor at AT	0.00 to 99.99	1.00	2
RE-D	Derivative time tuning factor at AT	0.00 to 99.99	1.00	2
RE, R	Control algorithm	0: PID (conventional PID) 1: Ra-PID (high performance type)	0	1
UF, OS	Just-FITTER overshoot suppression factor	0 to 100	0	1
SE, SH	ST step execution resolution width	0.00 to 99.99 %	10.00	2
SE, SB	ST step settling bound	0.00 to 10.00 %	0.50	2
SE, HB	ST hunting settling bound	0.00 to 10.00 %	1.00	2
SE, UD	ST step ramp change	0: ST is executed when the PV ramp up or down. 1: ST is executed only when the PV ramp up.	0	1

## [List of Parameter Setting Displays]

### ■ Mode bank

#### Bank selection: RRR

Display	Item	Contents	Initial value	User level
RR-R	AUTO/MANUAL mode selection	RR0: AUTO mode RR1: MANUAL mode	AUTO	0
RR-R	RUN/READY mode selection	RR2: RUN mode RR3: READY mode	RUN	0
RE	AT Stop/Start selection	RE OF: AT Stop RE ON: AT Start	AT Stop	0
DO, LE	Release all DO latches	LE ON: Latch continue LE OF: Latch release	Latch continue	0
LE, DI	Communication DI 1	DI OF: OFF DI ON: ON	OFF	0

### ■ SP bank

#### Bank selection: SP

Display	Item	Contents	Initial value	User level
SP-1 to SP-4	SP of LSP1 group to LSP4 group	SP low limit (C07) to SP high limit (C08)	0	0

### ■ Event bank

#### Bank selection: E1

Display	Item	Contents	Initial value	User level
E1 to E5	Internal event 1 to 5, main setting	-1999 to +9999 The decimal point position varies by meeting the internal event operation type.	0	0
E1.5b to E5.5b	Internal event 1 to 5, sub-setting	0 to 9999 for some operation type.	0	0
E1.HY to E5.HY	Internal event 1 to 5, hysteresis	0 to 9999 The decimal point position varies by meeting the internal event operation type.	5	0
E1.ON to E5.ON	Internal event 1 to 5, ON delay	0.0 to 999.9 (For the delay time unit 0.1s)	0	2
E1.OF to E5.OF	Internal event 1 to 5, OFF delay	0 to 9999 (Except for the delay time unit 0.1s)	0	2

■ Setup bank  
Bank selection: *SLUP*

Display	Item	Contents	Initial value	User level
└ 01	PV input range type	Thermocouple (T): 1 to 6, 9 to 11, 13 to 21, 24, 25	1	0
		RTD (R): 41 to 46, 51 to 54, 63, 64, 67, 68	41	
		DC current/voltage (L): 84, 86 to 90	88	
└ 02	Temperature unit	0: Centigrade (°C) 1: Fahrenheit (°F)	0	0
└ 03	Cold junction compensation (T/C)	0: Cold junction compensation is performed. (Internal) 1: Cold junction compensation is not performed. (External)	0	2
└ 04	Decimal point position	0: No decimal point 1: One digit below decimal point 2: Two digits below decimal point 3: Three digits below decimal point (Select '0' or '1' for the RTD range with decimal point)	0	0
└ 05	PV range low limit	When the PV input range type is thermocouple (T) or RTD (R), the setting is disabled although range low limit is displayed.	-	0
		-1999 to +9999U when the PV input range type is DC voltage/current (L).	0	
└ 06	PV range high	When the PV input range type is thermocouple (T) or RTD (R), the setting is disabled although range high limit is displayed.	-	0
		-1999 to +9999U when the PV input range type is DC voltage/current (L).	1000	
└ 07	SP low limit	PV input range low limit to PV input range high limit	0	1
└ 08	SP high limit		1000	1
└ 09	Squarer root extraction dropout	0.0 to 100.0% (0.0: No square root extraction)	0.0	2
└ 14	Control action (direct/reverse)	0: Heat control (reverse action) 1: Cool control (direct action)	0	0
└ 15	Selection of MV at PV alarm occurrence	0: Control operation is continued. 1: MV at PV alarm occurrence is outputted.	0	2
└ 16	MV at PV alarm occurrence	-10.0 to +110.0%	0.0	2
└ 17	MV at READY (at heat-side for heat/cool control)	-10.0 to +110.0%	0.0	1
└ 18	MV at READY (at cool-side)	-10.0 to +110.0%	0.0	1
└ 19	Operation at MANUAL change	0: Bump-less 1: Preset	0	1
└ 20	Preset MANUAL value	-10.0 to +110.0% (Used even at MANUAL mode when power is ON.)	0.0 or 50.0	1
└ 21	PID operation initialization function selection	0: Automatic 1: Not initialized 2: Initialized (when SP value different from current value is inputted.)	0	2
└ 22	PID operation initial MV	-10.0 to +110.0%	0.0 or 50.0	2
└ 26	Heat/cool control	0: Disabled. 1: Enabled.	0	0
└ 27	Heat/cool selection	0: Normal 1: Energy saving	0	1
└ 28	Dead zone	-100.0 to +100.0%	0.0	0
└ 29	Heat/cool control selection point	-10.0 to +110.0%	50.0	2
└ 30	LSP setting system	1 to 4	1	0
└ 32	SP ramp unit	0: 0.1U/s 1: 0.1U/min 2: 0.1U/h	1	2
└ 36	CT1 operation type	0: Heater burnout detection 1: Current value measurement	0	0
└ 37	CT1 output	0: Control output 1	0	0
		1: Control output 2		
		2: Event output 1		
		3: Event output 2		
└ 38	CT1 measurement wait time	30 to 300ms	30	0
└ 39	CT2 operation type	Same as CT1.	0	0
└ 40	CT2 output		0	0
└ 41	CT2 measurement wait time		30	0
└ 42	Control output 1 range	1: 4 to 2mA 2: 0 to 20mA	1	0
└ 43	Control output 1 type	0: MV	0	0
		1: Heat MV		
		2: Cool MV		
		3: PV		
		4: PV before ratio bias filter		
		5: SP		
		6: Deviation (PV-SP)		
		7: CT1 current value		
		8: CT2 current value		
		9: Invalid		
		10: SP+MV		
11: PV+MV				
└ 44	Control output 1 scaling low limit	-1999 to +9999 (The decimal point position and unit may vary depending on the control output 1 type.)	0.0	0
└ 45	Control output 1 scaling high limit		100.0	0
└ 46	Control output 1 MV scaling	0 to 9999 The decimal point position and unit are same as for PV.	200	0
└ 47	Control output 2 range	Same as control output 1.	1	0
└ 48	Control output 2 type		3	0
└ 49	Control output 2 scaling low limit	-1999 to +9999 (The decimal point position and unit may vary depending on the control output 2 type.)	0	0
└ 50	Control output 2 scaling high limit		1000	0
└ 51	Control output 2 MV scaling	0 to 9999 The decimal point position and unit are same as for PV.	200	0

Display	Item	Contents	Initial value	User level
└ 64	CPL/MODBUS	0: CPL 1: MODBUS ASCII format 2: MODBUS RTU format	0	0
└ 65	Station address	0 to 127 Communication is disabled when "0" is set.	0	0
└ 66	Transmission speed	0: 4800bps 1: 9600bps 2: 19200bps 3: 38400bps	2	0
└ 67	Data format (data length)	0: 7bits 1: 8bits	1	0
└ 68	Data format (parity)	0: Even parity 1: Odd parity 2: No parity	0	0
└ 69	Data format (stop bits)	0: 1bit 1: 2bits	0	0
└ 70	Communication minimum response time	1 to 250ms	3	2
└ 71	Key operation mode/type	0: Standard type 1: Special type	0	2
└ 72	MODE key function	0: Invalid	1	0
		1: AUTO/MANUAL selection		
		2: RUN/READY selection		
		3: AT Stop/Start		
		4: LSP group selection		
		5: Release of all DO latches		
		6: Invalid		
		7: Communication D11 selection		
8: Invalid				
└ 73	MODE display setup	Whether the mode bank setup display is enabled or disabled is determined by the sum of the following weighting: Bit 0: AUTO/MANUAL display 0: Disabled, +1: Enabled Bit 1: RUN/READY display 0: Disabled, +2: Enabled Bit 3: AT stop/start display 0: Disabled, +8: Enabled Bit 4: DO latch release 0: Disabled, +16: Enabled Bit 5: Communication D11 ON/OFF display 0: Disabled, +32: Enabled Other invalid setup: 0, +4, +64, +128	255	1
└ 74	PV/SP value display setup	Whether the basic display is enabled or disabled is determined by the sum of the following weighting: Bit 0: PV display 0: Disabled, +1: Enabled Bit 1: SP display 0: Disabled, +2: Enabled Bit 2: LSP group No. display 0: Disabled, +4: Enabled Other invalid setup: 0, +8	15	1
└ 75	MV display setup	Whether the basic display is enabled or disabled is determined by the sum of the following weighting: Bit 0: MV display 0: Disabled, +1: Enabled Bit 1: Heat MV/cool MV display 0: Disabled, +2: Enabled Bit 3: AT progress display 0: Disabled, +8: Enabled Other invalid setup: 0, +4	15	1
└ 76	Event setting value display setup	0: In the operation display mode, the internal event setting value is not displayed.	0	1
		1: In the operation display mode, the internal event 1 setting value is displayed.		
		2: In the operation display mode, the internal event 1 to 2 setting value is displayed.		
└ 77	Event remaining time display setup	0: In the operation display mode, the ON/OFF delay remaining time of the internal event is not displayed.	0	1
		1: In the operation display mode, the ON/OFF delay remaining time of the internal event 1 is displayed.		
		2: In the operation display mode, the ON/OFF delay remaining time of the internal event 1 to 2 is displayed.		
└ 78	CT input current value display setup	0: In the operation display mode, the CT current value is not displayed.	0	1
		1: In the operation display mode, the CT1 current value is displayed.		
└ 79	User level	0: Basic configuration	0	0
		1: Standard configuration		
└ 80	LED monitor	0: Disabled	0	2
		1: Flashing at RS-485 communication signal transmission		
		2: Flashing at RS-485 communication signal receiving		
		3: OR (logical sum) of all DI status		
└ 90	Number of CT1 turns	0: 800 turns 1 to 40: CT turns divided by 100.	8	2
└ 91	Number of CT1 power wire loops	0: 1 time 1 to 6: Number of times	1	2
└ 92	Number of CT2 turns	0: 800 turns 1 to 40: CT turns divided by 100.	8	2
└ 93	Number of CT2 power wire loops	0: 1 time 1 to 6: Number of times	1	2

(continued on back page)

■ Event assignment bank

Bank selection: EUCF

Display	Item	Contents	Initial value	User level
E4.C1 to E5.C1	Operation type of internal event 1 to 5 configuration 1	0: No event 1: PV high limit 2: PV low limit 3: PV high/low limit 4: Deviation high limit 5: Deviation low limit 6: Deviation high/low limit 7: Deviation high limit (Final SP reference) 8: Deviation low limit (Final SP reference) 9: Deviation high/low limit (Final SP reference) 10: SP high limit 11: SP low limit 12: SP high/low limit 13: MV high limit 14: MV low limit 15: MV high/low limit 16: CT1 heater burnout/over-current 17: CT1 heater short-circuit 18: CT2 heater burnout/over-current 19: CT2 heater short-circuit 20: Loop diagnosis 1 21: Loop diagnosis 2 22: Loop diagnosis 3 23: Alarm (status) 24: READY (status) 25: MANUAL (status) 26: Invalid 27: During AT execution (status) 28: During SP ramp (status) 29: Control direct action (status) 30: ST execution (status) 31: Invalid 32: Timer (status)	0	0
E4.C2 to E5.C2	Internal event 1 to 5 Configuration 2 1st digit: Direct/Reverse 2nd digit: Stand-by 3rd digit: EVENT state at READY 4th digit: Undefined	Digits are called as 1st digit, 2nd digit, 3rd digit and 4th digit from the right end digit. 0: Direct 1: Reverse 0: None 1: Standby 2: Standby + Standby at SP change 0: Continue 1: Forced OFF 0	0000 0 0 0 0	0
E4.C3 to E5.C3	Internal event 1 to 5 Configuration 3 1st digit: Alarm OR 2nd digit: Special OFF 3rd digit: Delay time unit 4th digit: Undefined	Digits are called as 1st digit, 2nd digit, 3rd digit and 4th digit from the right end digit. 0: No event 1: Alarm direct + OR operation 2: Alarm direct + AND operation 3: Alarm reverse + OR operation 4: Alarm reverse + AND operation 0: As normal execution 1: Event OFF at the event setting value (main)=0 0: 0.1s 1: 1s 2: 1min 0	0000 0 0 0 0	2

■ DI assignment bank

Bank selection: d

Display	Item	Contents	Initial value	User level
d1.1 to d1.3	Internal contact 1 to 3 Operation type	0: No function 1: LSP group selection (0/+1) 2: LSP group selection (0/+2) 3: LSP group selection (0/+4) 4: Invalid 5: Invalid 6: Invalid 7: RUN/READY selection 8: AUTO/MANUAL selection 9: Invalid 10: AT Stop/Start 11: ST Disabled/Enabled 12: Control action direct/reverse selection (As per setting/opposite operation of setting) 13: SP ramp Enabled/Disabled 14: PV hold (No-hold/Hold) 15: PV maximum value hold (No-hold/Hold) 16: PV minimum value hold (No-hold/Hold) 17: Timer Stop/Start 18: Release of all DO latches (Continue/Release) 19: Invalid 20: Invalid	0	0
d1.2 to d1.2	Internal contact 1 to 3 Input bit operation	0: Disabled. (Input of default) 1: Function 1 ((A and B) or (C and D)) 2: Function 2 ((A or B) and (C or D)) 3: Function 3 (A or B or C or D) 4: Function 4 (A and B and C and D)	0	2

Display	Item	Contents	Initial value	User level
d1.3 to d1.3	Internal contact 1 to 3 Input assignment A	0: Normally open (OFF, 0) 1: Normally close (ON, 1) 2: D1 3: D2 4 to 9: Undefined 10: Internal event 1 11: Internal event 2	2 to 4	2
d1.4 to d1.4	Internal contact 1 to 3 Input assignment B	12: Internal event 3 13: Internal event 4 14: Internal event 5 15 to 17: Undefined 18: Communication D11 19: Communication D12 20: Communication D13	0	2
d1.5 to d1.5	Internal contact 1 to 3 Input assignment C	21: Communication D14 22: MANUAL mode 23: READY mode 24: Undefined 25: During AT execution 26: During SP ramp 27: Undefined	0	2
d1.6 to d1.6	Internal contact 1 to 3 Input assignment D	28: Alarm is enabled. 29: PV alarm is enabled. 30: Undefined 31: Mode key function selection status 32: Event output 1 status 33: Control output 1 status	0	2
d1.7 to d1.7	Internal contact 1 to 3 Polarity A to D	Digits are called as 1st digit, 2nd digit, 3rd digit and 4th digit from the right end digit. 0: Direct 1: Reverse	0000	2
d1.8 to d1.8	Internal contact 1 to 3 Polarity A	0: Direct 1: Reverse	0	2
d1.9 to d1.9	Internal contact 1 to 3 Polarity B	0: Direct 1: Reverse	0	2
d1.10 to d1.10	Internal contact 1 to 3 Polarity C	0: Direct 1: Reverse	0	2
d1.11 to d1.11	Internal contact 1 to 3 Polarity D	0: Direct 1: Reverse	0	2

■ DO assignment bank

Bank selection: do

Display	Item	Contents	Initial value	User level
do1.1 to do1.1	Control output 1 to 2, event output 1 to 3 operation type	0: Input of default 1: MV1 (ON/OFF control output, time proportional output, heat-side proportional output of heat/cool control) 2: MV2 (cool-side proportional output of heat/cool control) 3: Function 1 ((A and B) or (C and D)) 4: Function 2 ((A or B) and (C or D)) 5: Function 3 (A or B or C or D) 6: Function 4 (A and B and C and D)	0	2
do1.2 to do1.2	Control output 1 to 2, event output 1 to 3 output assignment A	0: Normally open (OFF, 0) 1: Normally close (ON, 1) 2: Internal event 1 3: Internal event 2 4: Internal event 3 5: Internal event 4 6: Internal event 5 7 to 13: Undefined 14: MV1	14 to 15 or 2 to 4	2
do1.3 to do1.3	Control output 1 to 2, event output 1 to 3 output assignment B	15: MV2 16 to 17: Undefined 18: D11 19: D12 20 to 25: Undefined 26: Internal contact 1 27: Internal contact 2 28: Internal contact 3 29 to 33: Undefined	0	2
do1.4 to do1.4	Control output 1 to 2, event output 1 to 3 output assignment C	34: Communication D11 35: Communication D12 36: Communication D13 37: Communication D14 38: MANUAL mode 39: READY mode 40: Invalid 41: During AT execution 42: During SP ramp	0	2
do1.5 to do1.5	Control output 1 to 2, event output 1 to 3 output assignment D	43: Undefined 44: Alarm is enabled. 45: PV alarm is enabled. 46: Undefined 47: mode key function selection status 48: Event output 1 status 49: Control output 1 status	0	2

Display	Item	Contents	Initial value	User level
oE 1.6 to oE2.6 Ev 1.6 to Ev3.6	Control output 1 to 2, event output 1 to 2 Polarity A to D	Digits are called as 1st digit, 2nd digit, 3rd digit and 4th digit from the right end digit. 0: Direct 1: Reverse	0000 0 0 0 0	2
oE 1.7 to oE2.7 Ev 1.7 to Ev3.7	Control output 1 to 2, event output 1 to 3 Polarity	0: Direct 1: Reverse	0	2
oE 1.8 to oE2.8 Ev 1.8 to Ev3.8	Control output 1 to 2, event output 1 to 3 Latch	0: Disabled 1: Enabled (Latch at ON) 2: Enabled (Latch at OFF, except at the time of initialization after power ON)	0	2

## ■ User function bank

Bank selection: **UF**

Display	Item	Contents	Initial value	User level
UF-1	User function definition 1	This is the display in upper display. The setup exception is as follows: - - - - : Yet to be registered.	- - - -	1
UF-2	User function definition 2	P - - - : Proportional band of the PID group in use I - - - : Integration time of the PID group in use d - - - : Derivative time of the PID group in use rE - - : Manual reset of the PID group in use	- - - -	1
UF-3	User function definition 3	oL - - : MV low limit of the PID group in use oH - - : MV high limit of the PID group in use	- - - -	1
UF-4	User function definition 4	P - _L : Cool-side proportional band of the PID group in use	- - - -	1
UF-5	User function definition 5	I - _L : Cool-side integration time of the PID group in use	- - - -	1
UF-6	User function definition 6	d - _L : Cool-side derivative time of the PID group in use	- - - -	1
UF-7	User function definition 7	oL _L : Cool-side MV low limit of the PID group in use	- - - -	1
UF-8	User function definition 8	oH _L : Cool-side of MV high limit of the PID group in use	- - - -	1

## ■ Lock bank

Bank selection: **LoL**

Display	Item	Contents	Initial value	User level
LoL	Key lock	0: All settings are enabled. 1: Mode, event, operation display, SP, UF, lock, manual MV, and mode key can be set. 2: Operation display, SP, UF, lock, manual MV, and mode key can be set. 3: UF, lock, manual MV, and mode key can be set.	0	0
L. LoL	Communication lock	0: RS-485 communication read/write is enabled. 1: RS-485 communication read/write is disabled.	0	2
L. LoL	Loader lock	0: Loader communication read/write is enabled. 1: Loader communication read/write is disabled.	0	2
PR55	Password display	0 to 15 5: Password 1A to 2B display	0	0
PS 1R	Password 1A	0000 to FFFF (hexadecimal value)	0000	0
PS 2R	Password 2A	0000 to FFFF (hexadecimal value)	0000	0
PS 1b	Password 1B	0000 to FFFF (hexadecimal value)	0000	0
PS 2b	Password 2B	0000 to FFFF (hexadecimal value)	0000	0

## ■ Instrument information bank

Bank selection: **Id**

Display	Item	Contents	Initial value	User level
Id01	ROM ID	0: fixed	-	2
Id02	ROM version 1	XX.XX (2 digits after decimal point)	-	2
Id03	ROM version 2	XX.XX (2 digits after decimal point)	-	2
Id04	SLP support Information		-	2
Id05	EST support version		-	2
Id06	Manufacturing date code (year)	Year - 2000 Ex.: "3" means the year 2003.	-	2
Id07	Manufacturing date code (month, day)	Month + Day = 100 Ex.: "12.01" means the 1st day of December	-	2
Id08	Serial No.		-	2

CP-UM-5410EC-1

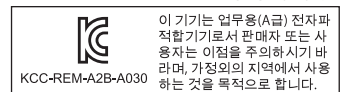

**azbil**

Specifications are subject to change without notice. (09)

Azbil Corporation  
Advanced Automation Company

1-12-2 Kawana, Fujisawa  
Kanagawa 251-8522 Japan

URL: <http://www.azbil.com>

1st edition: Mar. 2006  
13th edition: Mar. 2015 (F)



# 数字显示调节器 C15M 使用说明书 设置篇

感谢您购买阿自倍尔株式会社产品。

为了正确、安全的使用本产品，请务必阅读本使用说明书，在阅读、理解本书的基础上进行使用。

在订购及使用产品之际，请务必登入以下网站，浏览“产品订购注意事项”。

<http://www.azbil.com/cn/products/order.html>

中英文版的内容如有差异，以英文版为准。

## 要求

请确保把本使用说明书送到本产品使用者手中。

禁止擅自复印和转载全部或部分本使用说明书的内容。

今后内容变更时恕不事先通知。

本使用说明书的内容经过仔细审查校对，万一有错误和遗漏，请向本公司提出。

对客户应用结果，本公司有不能承担责任的场合，敬请谅解。

©2006-2015 Azbil Corporation All Rights Reserved.

本书对使用上的注意事项和安装、接线、PV量程种类、参数一览、主要规格等进行说明。

## 请确认

您购买的C15MT含有以下物品

安装件	81409651-001	1 个
密封垫	81409657-001	1 个
使用说明书(本书)	CP-UM-5410EC	1 本

## 安全注意事项



### 警告

错误使用时，可能会造成使用者死亡或负重伤的危险状态。



### 注意

错误使用时，可能会发生使用者负轻伤或造成物品损坏的危险状态。

## 警告



本机的接线错误会造成故障或产生危险灾害。  
本机在通电前，请务必确认接线是否正确。



本机的接线或安装、拆卸时，请务必在切断电源的情况下进行。



请勿触摸电源端子等受电体。  
否则可能会触电。



请勿分解本机。  
否则可能会触电及产生故障。

## 注意



请在规格规定的使用条件(温度、湿度、电压、振动、冲击、安装方向、环境等)范围内使用本机。  
否则可能会引起火灾、产生故障。



请勿遮盖本机的通风口。  
否则可能会引起火灾或产生故障。



请按照规定的基准、指定的电源及施工方法进行正确配线。  
否则可能会引起火灾、触电、故障。



避免线头、切削粉、水等进入本机内部。  
否则可能发生火灾、故障。



请按照端子螺丝规格中记载的扭矩切实拧紧螺丝。  
如果紧固不充分，可能会触电、引起火灾。



请勿把本机未使用端子作为中继端子使用。  
否则可能会触电、发生火灾、产生故障。



本机接线后建议盖上端子盖。  
否则可能会触电。(本机的端子盖是另售品)



请按规格中记载的寿命范围内使用本机的继电器。  
过度使用后可能引起火灾、产生故障。



有雷浪涌的场合，请使用本公司生产的浪涌吸收器。  
否则可能会引起火灾、产生故障。



请勿用头部尖锐的物品(铅笔尖或针等)操作键。  
否则会产生故障。

## 设置

### ■ 安装场所

请把本机设置在如下场所。

- 除供电电源及继电器接点输出外，输入输出模块的共模电压：对大地间的电压为30Vr.m.s以下，峰值42.4以下，DC60V以下。
- 无高温、低温、高湿度、低湿度的场所。
- 无硫化气等腐蚀性气体及硅气体的场所。
- 粉尘、油烟较少的场所。
- 无直射阳光及风雨不能直接接触的场所。
- 机械振动、冲击少的场所。
- 远离高压线、焊接机附近及电气干扰发生源附近的场所。
- 远离如锅炉等有高压点火装置 15m 以上的场所。
- 受电磁干扰少的场所
- 无可燃性液体或蒸汽的场所
- 室内

### ■ 安装方法

- 安装角度从水平位置向后仰10度以内、向前倾10度以内。
- 仪表盘安装型(C15MT)的场合，请使用板厚在9mm以下的钢板。

### ■ 外型尺寸

#### ● C15MT(盘安装型)

(单位: mm)

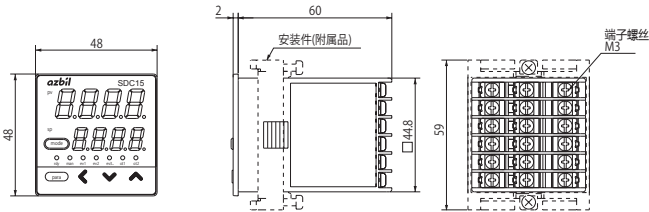

#### ! 使用上的注意事项

- 拧紧附属的安装件螺丝，直到安装件不再活动后再拧1圈螺丝，固定在仪表盘上。
- 请勿将螺丝拧得过紧，否则会使机箱变形。

#### ● 盘开孔图

单台安装

密集安装

(单位: mm)

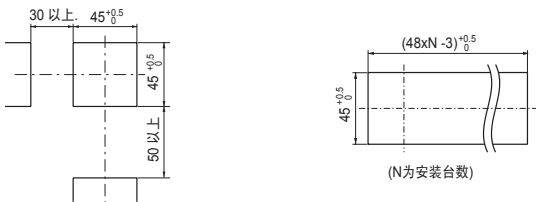

#### ! 使用上的注意事项

- 3台以上横向密集安装的场合，环境温度不要超过40°C。
- 需要防水、防尘的场合，请单台安装。已经密集安装的场合，不能保证防水、防尘性能。
- 上下方向保持50mm以上的间隔。

## 接线

进行仪表电源配线时，请将本产品的主电源切断开关设置在操作员手能触及的范围内。

另外，进行AC电源型的仪表电源配线时，请配上滞后型(T)额定电流0.2A、额定电压250V的保险丝。(IEC127)

仪表侧面的端子配列标号的含义如下表所示。

记号	内容
~	交流
⚠	注意、触电的危险
⚠	注意

#### ! 使用上的注意事项

- 请在确认贴在本机侧面的仪表型号与端子编号后进行接线。接线完毕后，请务必确认接线无误。
- 输入输出信号线远离动力线或电源线50cm以上，而且不能在同一配线管或线槽内。
- 请注意压接端子等不能与相邻的端子接触。
- 1个端子螺丝连接多个压接端子的场合，请事先把压接端子弯曲处理并连接不超过2个压接端子。
- 1~6, 13~18号端子的配线请从端子台侧看的左方向进行配线。
- 端子连接时请使用适合M3螺丝的下述尺寸的端子。

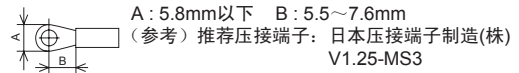

- 仪表电源为OFF时，电流输入回路被断开。当计装设计需数台仪表的电流输入串联时，请配上另售的电阻(81401325)，取其电压作为电压量程使用。
- 请把流过加热电流的导线贯通在电流互感器中。同时，请勿在超过规格中规定的容许电流的情况下使用。否则会损坏本机。
- 本机在电源投入后进入稳定状态前，最长6s内不动作。其后进入运行状态，但为了保证规定的精度，请预热30分钟以上。
- 电流互感器输入不能用于位相控制。
- 控制输出1与控制输出2之间未隔离。请根据需要进行隔离。
- RS-485的通信路的两端上请勿连接终端电阻。否则不能通讯。
- 与本机连接的机器或装置，需采取与本机的电源、输入输出部的最高使用电压适合的强化绝缘措施后，才能使用。

#### ● C15MT的接线

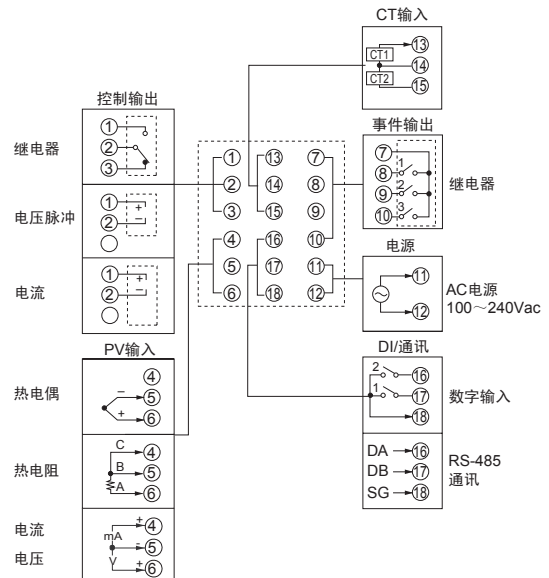

#### ● 输入输出间隔离

实线围住部分与其它信号隔离。  
有无输入输出根据型号决定。

电源	内部回路	控制输出1
PV输入		控制输出2
CT输入1	事件输出1(注) 事件输出2(注) 事件输出3	
CT输入2		
编程器通讯		
数字输入1		
数字输入2		
RS-485通讯		

## 各部件的名称和功能

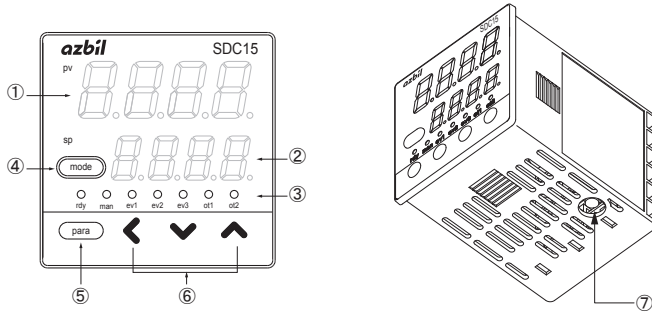

- ① 第1显示器: 显示PV值(现在的温度等)或设定项目。
- ② 第2显示器: 显示SP值(设定温度值等)或各设定项目的设定值。
- ③ 模式显示灯 rdy: READY模式(控制停止)时灯亮  
man: MANUAL模式(手动)时灯亮  
ev1~ev3: 事件继电器输出ON时灯亮  
ot1~ot2: 控制输出为ON时灯亮
- ④ [mode]键: 连续按键1s以上时可进行预先设定的操作。出厂时设定为RUN/READY切换。
- ⑤ [para]键: 显示切换。
- ⑥ <、V、^键: 数值增减、位变更时使用。
- ⑦ 编程器插口: 使用智能编程器软件包同包装的专用电缆与计算机连接。

## 键操作和设定

下图表示键操作的流程。各种显示或设定可以从面板上调出。

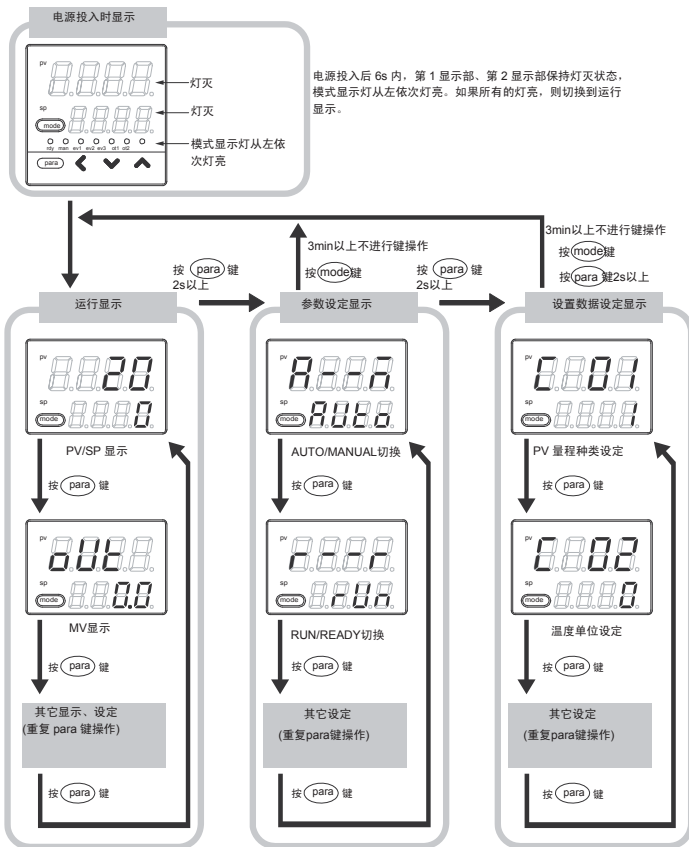

此图中描写的显示或设定状态是说明用的例子。实际中根据型号或设定内容，显示或设定可能不显示。

### ● PV输入量程的设定

设定显示「C01」下按[<]、[V]、[^]键，在第2显示部上设定希望的PV量程种类。  
不需按键，只要经过2s以上时，闪烁将停止，PV量程种类的设定完成。

### ● SP的设定

运行显示的PV/SP显示中按[<]、[V]、[^]键，变更第2显示部的SP。  
不需按键，只要经过2s以上时，数值闪烁将停止，确定设定值。  
SP在参数设定显示下也可以设定。

## PV量程表

C01编号	传感器类型	量程	C01 编号	传感器类型	量程
1	K	-200~+1200°C	41	Pt100	-200~+500°C
2	K	0~1200°C	42	JPt100	-200~+500°C
3	K	0.0~800.0°C	43	Pt100	-200~+200°C
4	K	0.0~600.0°C	44	JPt100	-200~+200°C
5	K	0.0~400.0°C	45	Pt100	-100~+300°C
6	K	-200.0~+400.0°C	46	JPt100	-100~+300°C
9	J	0.0~800.0°C	51	Pt100	-50.0~+200.0°C
10	J	0.0~600.0°C	52	JPt100	-50.0~+200.0°C
11	J	-200.0~+400.0°C	53	Pt100	-50.0~+100.0°C
13	E	0.0~600.0°C	54	JPt100	-50.0~+100.0°C
14	T	-200.0~+400.0°C	63	Pt100	0.0~200.0°C
15	R	0~1600°C	64	JPt100	0.0~200.0°C
16	S	0~1600°C	67	Pt100	0~500°C
17	B	0~1800°C	68	JPt100	0~500°C
18	N	0~1300°C			
19	PL II	0~1300°C	C01编号	输入类型	量程
20	WRe5-26	0~1400°C	84	0~1V	-1999~+9999的 量程范围，小数点位置 可变
21	WRe5-26	0~2300°C	86	1~5V	
24	DIN U	-200.0~+400.0°C	87	0~5V	
25	DIN L	-100.0~+800.0°C	88	0~10V	
			89	0~20mA	
			90	4~20mA	

### ! 使用上的注意事项

- B型热电偶的精度为260°C以下±5%FS、260~800°C±1%FS。
- 在0~32°F的工程量范围内，PL II热电偶(C01 No.19)的指示精度不能满足本规格书的规定。
- 带小数点显示的量程，显示小数点以下1位。
- 根据使用传感器的类型与量程，设定设置数据C01的编号。请用设置数据C01设定正确的传感器的类型及量程的编号，否则会引起大的温度误差而导致异常输出。

## 报警代码一览表

报警代码	异常名称	原因	处理
RL01	PV输入异常(超量程)	传感器断线、误配线 PV量程种类误设定	确认配线 再次设定PV量程种类
RL02	PV输入异常(欠量程)	传感器断线、误配线 PV量程种类误设定	
RL03	CJ异常	端子温度补偿部故障(热电偶)	确认环境温度
	PV输入异常	传感器断线、误配线(热电阻)	确认配线
RL11	CT输入异常(超量程)	超过显示范围上限的电流测量、CT匝数误设定、CT电力线贯通次数的误设定 误配线	使用匝数与显示范围符合的CT、匝数的再设定、CT电力线贯通次数的再设定、配线的确认
RL10	A/D转换异常	A/D转换部故障	更换本体
RL95	参数异常	数据确定中断电 因干扰等数据被破坏	• 再次投入电源 • 再次设定数据
RL96	调整数据异常	数据确定中断电 因干扰等数据被破坏	(AL95/97为设定数据，AL96/98为调整数据) • 更换本体
RL97	参数异常(RAM区域)	因干扰等数据被破坏	
RL98	调整数据异常(RAM区域)	因干扰等数据被破坏	
RL99	ROM异常	ROM(内存)故障	• 再次投入电源 • 更换本体

## 维护

清扫 : 清除仪表污物时, 请使用柔软的干布擦拭。

部件更换 : 请勿更换部件。

保险丝更换 : 在更换AC电源型的电源保险丝时, 务必使用指定规格的产品。  
规格IEC127、切断速度 滞后型(T)、 额定电压250V、 额定电流0.2A。

## 型号构成表

基本型号	安装	控制输出	PV输入	电源	选项	语言	规格
C15M	T						盘安装型
							控制输出1(ot1) 控制输出2(ot2)
		R0					继电器输出(NO) 继电器输出(NC)
		V0					电压脉冲输出 (SSR驱动用) 无
		C0					电流输出 无
			T				热电偶输入 (K, J, E, T, R, S, B, N, PLII, WRe5-26, DINU, DINL)
			R				热电阻输入 (Pt100/JPt 100)
			L				直流电压 / 电流输入 (0~1Vdc, 1~5Vdc, 0~5Vdc, 0~10Vdc, 0~20mAdc, 4~20mAdc)
			A				AC电源 (100 ~ 240Vac)
						01	事件输出3点
						02	事件继电器输出3点 电流互感器输入2点 数字输入2点
						03	事件继电器输出3点 电流互感器输入2点 RS-485通讯
				00	中文 (简体字)		
				01	中文 (繁体字)		

## 规格

### ● PV输入

热电偶 : K, J, E, T, R, S, B, N(JIS C 1602-1995) PL II(Engelhard Industries资料(ITS90)) WRe5-26(ASTM E988-96(Reapproved 2002)) DIN U, DIN L(DIN 43710-1985)

热电阻 : Pt100(JIS C 1604-1997) JPt100(JIS C 1604-1989)

直流电压 : 0~1V, 1~5V, 0~5V, 0~10V

直流电流 : 0~20mA, 4~20mA

采样周期 : 500ms

显示精度 : ±0.5%FS±1digit  
热电偶的负区域是±1%FS±1digit (环境温度23±3°C)

容许输入 : -0.5V~+12V (热电偶、热电阻、直流电压) 30mA以下或4V以下 (直流电流)  
如果输入容许输入值以上的电压或电流, 有可能损坏仪表

### ● 数字输入

输入形式 : 无电压接点或开路集电极

容许ON接点电阻 : 250Ω以下

容许OFF接点电阻 : 100kΩ以上

容许ON残留电压 : 1.0V以下

ON时端子电流 : 约7.5mA (短路时) 约5.0mA (接点电阻250Ω时)

最小保持时间 : 1s以上

### ● 电流互感器输入

点数 : 2点

输入对象 : 电流互感器卷数100~4000匝(按100匝单位对应)  
另售品型号: QN206A(800匝、孔径5.8mm)  
另售品型号: QN212A(800匝、孔径12mm)

测量电流下限 : 0.4Aac(800匝, 在电力线贯穿次数为1时)  
计算式: 匝数 ÷ (2000 × 电力线贯穿次数)

测量电流上限 : 50.0Aac(800匝、在电力线贯穿次数为1时)  
计算式: 匝数 ÷ (16 × 电力线贯穿次数)

容许测量电流 : 70.0Aac以下(800匝、在电力线贯穿次数为1时)  
计算式: 匝数 ÷ (16 × 电力线贯穿次数) × 1.4

显示范围下限 : 0.0Aac

显示范围上限 : 70.0Aac(800匝、在电力线贯穿次数为1时)  
计算式: 匝数 ÷ (16 × 电力线贯穿次数) × 1.4

显示精度 : ±5%FS

显示分辨率 : 0.1Aac

### ● 控制输出

继电器输出  
接点额定值 : 控制输出 NO侧250Vac/30Vdc、3A(电阻负荷)  
控制输出 NC侧250Vac/30Vdc、1A(电阻负荷)

寿命 : NO侧5万次以上、NC侧 10万次以上

最小开闭规格 : 5V、100mA

最小开时间/闭时间 : 250ms

电压脉冲输出 (SSR驱动用)  
开路时电压 : 19Vdc±15%

内部电阻 : 82Ω±0.5%

容许电流 : 24mAdc 以下(输出超过该值时, 有可能损坏输出回路。)

最小OFF时间/ON时间 : 时间比例周期小于10s时 1ms  
时间比例周期大于10s时 250ms

### ● 电流输出

输出形式 : 0~20mAdc或4~20mA电流输出

容许负载电阻 : 600Ω 以下

输出精度 : ±0.5%FS (环境温度23±3°C时)  
但0~1mA时为±1%FS

### ● 事件继电器输出 (ev1~3)

接点额定值 : 250Vac /30Vdc 2A (电阻负载)

寿命 : 10万次 以上

最小开闭规格 : 5V、10mA(参考值)

### ● RS-485通讯

传送路 : 3线式

传送速度 : 4800、9600、19200、38400bps

通讯协议 : 基于CPL、MODBUS标准

终端电阻 : 禁止连接

### ● 环境条件

动作条件 : 0~50°C (密集安装の場合为0~40°C)

环境温度 : 10~90%RH (无结露)

环境湿度 : 10~90%RH (无结露)

电源电压 : AC电源型85~264Vac、50/60Hz±2Hz (额定值: 100~240Vac 50/60Hz)

### ● 运输条件

环境温度 : -20~+70°C

环境湿度 : 10~95%RH (无结露)

### ● 其他规格

保护等级 : 机器面板IP66/NEMA 4基准 (使用付属的垫片时, 仅限于盘单个安装)

消耗功率 : AC电源型 : 12VA 以下(100Vac时8VA、264Vac时12VA) (与本公司SDC10相当功能の場合, 100Vac时6VA、264Vac时9VA)

断电停歇时间 : AC电源型 20ms以下

高度 : 2000m 以下

质量 : 盘安装型 约150g (含专用安装件)

端子螺丝拧紧扭矩 : 0.4~0.6N·m

适合规格 : EN61010-1、EN61326-1(For use in industrial locations) 在EMC试验中, 有产生相当于±10%FS的指示值或输出值变动的情况。

过电压类别 : Category II (IEC60364-4-443、IEC60664-1)

容许污染度 : Pollution degree2

使用电缆 : 热电偶输入

请直接把热电偶引线连接到端子上。  
配线距离长的場合或热电偶是端子连接の場合, 请用补偿导线延长后与端子连接。  
其它的输入输出  
请使用与JCS-4364弱电仪表用电缆相当的产品。电磁干扰比较小的場合, 可使用带屏蔽的多芯微音器电缆(MVVS)。

## 附属品·选项部件一览表

名称	型号
安装件 (C15MT用)	81409651-001 (附属品)
密封垫 (C15MT用)	81409657-001 (附属品)
电流互感器	QN206A (孔径5.8mm) QN212A (孔径12mm)
硬盖	81446442-001
软盖	81446443-001
端子盖	81446898-001

# C15M参数一览表

## [运行显示一览表]

### ■ 运行显示

显示	项目	内容	初始值	显示级别
第1显示: PV 第2显示: SP	SP(目标值)	SP下限(C07)~ SP上限(C08)	0	0
LSP1 第2显示: LSP	LSP组编号 (第1位=最右位的数值)	1~LSP使用组数(C30、最大4)	1	0
MV	MV(操作量)	-10.0~+110.0% AUTO模式下设定不可 (无数值闪烁) MANUAL模式下设定可能 (数值闪烁)	-	0
HEAT	加热MV(操作量)	设定不可	-	0
COOL	冷却MV(操作量)	-10.0~+110.0%	-	0
第1显示: PV AT(显示例)	AT进程 (第1位=最右位的数值)	设定不可 1~: AT启动中(值减小)	-	0
CT1	CT(电流互感器)输入1 电流值	设定不可	-	0
CT2	CT(电流互感器)输入2 电流值	设定不可	-	0
E1	内部事件1主设定	根据内部事件动作种类, 可设定的范围不同	0	0
E1.5b	内部事件1副设定	-1999~+9999U: 下述以外的场合 0~9999U: 设定值是绝对值的场合 -199.9~+999.9%: MV的场合	0	0
t1	定时器剩余时间1	设定不可 第1显示: 「t1」的旁边显示ON延迟、 OFF延迟的区别 第2显示: 内部事件1延迟时间 按照单位(E1.C3的第3位)的单位 (0.1s、s、min中的一个)显示	-	0
E2	内部事件2主设定	根据内部事件动作种类, 可设定的范围不同	0	0
E2.5b	内部事件2副设定	-1999~+9999U: 下述以外的场合 0~9999U: 设定值是绝对值的场合 -199.9~+999.9%: MV的场合	0	0
t2	定时器剩余时间2	设定不可 第1显示: 「t2」的旁边显示ON延迟、 OFF延迟的区别 第2显示: 内部事件2延迟时间 按照单位(E2.C3的第3位)的单位 (0.1s、s、min中的一个)显示	-	0
E3	内部事件3主设定	根据内部事件动作种类, 可设定的范围不同	0	0
E3.5b	内部事件3副设定	-1999~+9999U: 下述以外的场合 0~9999U: 设定值是绝对值的场合 -199.9~+999.9%: MV的场合	0	0
t3	定时器剩余时间3	设定不可 第1显示: 「t3」的旁边显示ON延迟、 OFF延迟的区别 第2显示: 内部事件3延迟时间 按照单位(E3.C3的第3位)的单位 (0.1s、s、min中的一个)显示	-	0

## [参数设定显示一览表]

### ■ 模式库

库选择: *mode*

显示	项目	内容	初始值	显示级别
R--n	AUTO/MANUAL模式 切换	AUTO: AUTO(自动)模式 n-an: MANUAL(手动)模式	AUTO	0
r--r	RUN/READY模式切换	RUN: RUN模式 RDY: READY模式	RUN	0
At	AT停止/启动切换	At.oF: AT停止 At.oN: AT启动	AT停止	0
do.Lt	全DO锁定解除	Lt.oN: 锁定继续 Lt.oF: 锁定解除	锁定继续	0
C.dH	通讯DI1	dl.oF: OFF dl.oN: ON	OFF	0

### ■ SP库

库选择: *SP*

显示	项目	内容	初始值	显示级别
SP-1 ~ SP-4	LSP1~4组的SP	SP下限(C07) ~ SP上限(C08)	0	0

### ■ 事件库

库选择: *EU*

显示	项目	内容	初始值	显示级别
E1 ~ E5	内部事件1~5主设定	-1999~+9999	0	0
E1.5b ~ E5.5b	内部事件1~5副设定	小数点位置根据内部事件动作种类变化 一部分的动作种类为0~9999	0	0
E1.H ~ E5.H	内部事件1~5回差	0~9999 小数点位置根据内部事件动作种类变化	5	0
E1.oN ~ E5.oN	内部事件1~5 ON延迟	0.0~999.9 (延迟时间单位0.1s的场合)	0	2
E1.oF ~ E5.oF	内部事件1~5 OFF延迟	0~9999 (延迟时间单位0.1s以外的场合)	0	2

显示级别的含义 0: 简单、标准、多功能显示,

1: 标准、多功能显示

2: 多功能显示

初始值有根据型号变化的情况。

### ■ PID库

库选择: *Pid*

显示	项目	内容	初始值	显示级别
P-i	比例带	0.1~999.9%	5.0	0
I-i	积分时间	0~9999s (0时无积分动作)	120	0
D-i	微分时间	0~9999s (0时无微分动作)	30	0
rE-i	手动复位	-10.0~+110.0%	50.0	0
oL-i	操作量下限	-10.0~+110.0%	0.0	1
oH-i	操作量上限	-10.0~+110.0%	100.0	1
P-iC	冷却侧比例带	0.1~999.9%	5.0	0
I-iC	冷却侧积分时间	0~9999s (0时无积分动作)	120	0
D-iC	冷却侧微分时间	0~9999s (0时无微分动作)	30	0
oL.iC	冷却侧操作量下限	-10.0~+110.0%	0.0	1
oH.iC	冷却侧操作量上限	-10.0~+110.0%	100.0	1

### ■ 参数库

库选择: *PARA*

显示	项目	内容	初始值	显示级别
Ctrl	控制方式	0: ON/OFF控制 1: PID固定 2: ST(自适应)	0、 或1	0
At.oL	AT时操作量下限	-10.0~+110.0%	0.0	0
At.oH	AT时操作量上限	-10.0~+110.0%	100.0	0
dIFF	ON/OFF控制差动	0~9999U	5	0
oFF5	ON/OFF控制动作点偏移量	-1999~+9999U	0	2
FL	PV滤波	0.0~120.0s	0.0	0
rR	PV比率	0.001~9.999	1.000	1
bI	PV偏置	-1999~+9999U	0	0
CVU	时间比例单位1	0: 1s单位 1: 0.5s固定(周期设定不可) 2: 0.2s固定(周期设定不可) 3: 0.1s固定(周期设定不可)	0	2
CV	时间比例周期1	5~120s (输出中包含继电器输出的场合) 1~120s (输出中不包含继电器输出的场合)	10、 或2	0
CVU2	时间比例单位2	0: 1s单位 1: 0.5s固定(周期设定不可) 2: 0.2s固定(周期设定不可) 3: 0.1s固定(周期设定不可)	0	2
CV2	时间比例周期2	5~120s (输出中包含继电器输出的场合) 1~120s (输出中不包含继电器输出的场合)	10、 或2	0
tP.tY	时间比例动作种类	0: 控制性重视型 1: 操作端寿命重视型(时间比例周期内仅1回ON/OFF动作)	0、 或1	2
SPU	SP斜坡上升斜率	0.0~999.9U (0.0U时无斜率)	0.0	2
SPD	SP斜坡下降斜率		0.0	2

### ■ 扩展调整库

库选择: *ET*

显示	项目	内容	初始值	显示级别
At.tY	AT种类	0: 通常(标准的控制特性) 1: 立即响应(对于干扰迅速反应的控制特性) 2: 稳定(PV上下波动少的控制特性)	1	0
JF.bd	JF整定幅	0.00~10.00	0.30	2
SP.LG	SP抑制时常数	0.0~999.9	0.0	2
At-P	AT时比例带调整系数	0.00~99.99	1.00	2
At-I	AT时积分时间调整系数	0.00~99.99	1.00	2
At-D	AT时微分时间调整系数	0.00~99.99	1.00	2
Ctrl.R	控制运算	0: PID(传统型PID) 1: Ra-PID(高性能型PID)	0	1
JF.oV	JF超调抑制系数	0~100	0	1
St.SR	ST阶跃执行判定幅	0.00~99.99	10.00	2
St.Sb	ST阶跃整定幅	0.00~10.00	0.50	2
St.Hb	ST振荡整定幅	0.00~10.00	1.00	2
St.Ld	ST阶跃升降切换	0: PV上升/下降时均执行ST 1: 仅PV上升时执行ST	0	1

■设置库

库选择: *SLUP*

显示	项目	内容	初始值	显示级别
C01	PV量程种类	热电偶(T)的场合: 1~6、9~11、13~21、24、25	1	0
		热电阻(R)的场合: 41~46、51~54、63、64、67、68	41	
		直流电压/直流电流(L)的场合: 84、86~90	88	
C02	温度单位	0: 摄氏(°C) 1: 华氏(°F)	0	0
C03	冷端补偿	0: 进行冷端补偿(内部) 1: 不进行冷端补偿(外部)	0	2
C04	小数点位置	0: 无小数点 1: 小数点以下1位 2: 小数点以下2位 3: 小数点以下3位 (热电阻带小数点量程的场合0~1)	0	0
C05	PV量程下限	PV输入型号为热电偶(T)、热电阻(R)的场合, 显示量程的下限, 但设定不可	-	0
		PV输入型号为直流电压/直流电流(L)的场合, -1999~+9999U	0	
C06	PV量程上限	PV输入型号为热电偶(T)、热电阻(R)的场合, 显示量程的上限, 但设定不可	-	0
		PV输入型号为直流电压/直流电流(L)的场合, -1999~+9999U	1000	
C07	SP限幅下限	PV量程下限~PV量程上限	-	1
C08	SP限幅上限		-	1
C09	开方运算小数舍去	0.0~100.0% (0.0时无开方运算)	0.0	2
C14	控制动作(正逆)	0: 加热控制(逆动作) 1: 冷却控制(正动作)	0	0
C15	PV异常时操作量选择	0: 继续控制运算 1: PV异常时输出操作量	0	2
C16	PV异常时操作量	-10.0~+110.0%	0.0	2
C17	READY时操作量(加热冷却控制的场合为加热侧)	-10.0~+110.0%	0.0	1
C18	READY时操作量(冷却侧)	-10.0~+110.0%	0.0	1
C19	MANUAL变更时动作	0: 无扰 1: 预置	0	1
C20	预置MANUAL值	-10.0~+110.0% (电源ON时、处于MANUAL模式时也使用)	0.0或50.0	1
C21	PID运算初始化功能选择	0: 自动 1: 不初始化 2: 初始化 (输入和现在值不同的SP值时)	0	2
C22	PID运算初始操作量	-10.0~+110.0%	0.0或50.0	2
C26	加热冷却控制选择	0: 不使用 1: 使用	0	0
C27	加热冷却切换	0: 通常 1: 节能	0	1
C28	加热冷却控制不感带	-100.0~+100.0%	0.0	0
C29	加热冷却控制切换点	-10.0~+110.0%	50.0	2
C30	LSP使用组数	1~4	1	0
C32	SP斜坡单位	0: 0.1U/s 1: 0.1U/min 2: 0.1U/h	1	2
C36	CT1动作	0: 加热器断线检测 1: 电流值测定	0	0
C37	CT1监视输出	0: 控制输出1 1: 控制输出2 2: 事件输出1 3: 事件输出2 4: 事件输出3	0	0
C38	CT1测定等待时间	30~300ms	30	0
C39	CT2动作	和CT1相同	0	0
C40	CT2监视输出		0	0
C41	CT2测定等待时间		30	0
C42	控制输出1量程	1: 4~20mA 2: 0~20mA	1	0
C43	控制输出1种类	0: MV 1: 加热MV(加热冷却控制用) 2: 冷却MV(加热冷却控制用) 3: PV 4: 比率、偏差、滤波前PV 5: SP 6: 偏差(PV-SP) 7: CT1电流值 8: CT2电流值 9: MFB(C15M时无效) 10: SP+MV 11: PV+MV	0	0
C44	控制输出1量程下限	-1999~+9999(小数点位置根据控制输出1的种类变化)	0.0	0
C45	控制输出1量程上限		100.0	0
C46	控制输出1 MV量程幅	0~9999 小数点位置及单位与PV相同	200	0
C47	控制输出2量程	与控制输出1相同	13	0
C48	控制输出2量程种类			0
C49	控制输出2量程下限	-1999~+9999(小数点位置根据控制输出2的种类变化)	0	0
C50	控制输出2量程上限		1000	00
C51	控制输出2 MV量程幅	0~9999 小数点位置及单位与PV相同	200	0

显示	项目	内容	初始值	显示级别
C64	通讯种类	0: CPL 1: MODBUSASCII形式 2: MODBUSRTU形式	0	0
C65	机器地址	0~127 (0时不通讯)	0	0
C66	传送速度	0: 4800bps 1: 9600bps 2: 19200bps 3: 38400bps	2	0
C67	数据形式(数据长)	0: 7位 1: 8位	1	0
C68	数据形式(校验)	0: 偶数校验 1: 奇数校验 2: 无校验	0	0
C69	数据形式(停止位)	0: 1位 1: 2位	0	0
C70	通讯最小应答时间	1~250ms	3	2
C71	键操作种类	0: 标准型 1: 特殊型	0	2
C72	Mode键功能	0: 无效 1: AUTO/MANUAL切换 2: RUN/READY切换 3: AT停止/启动 4: LSP组切换 5: 全DO锁定解除 6: 无效 7: 通讯DI1切换 8: 无效	1	0
C73	模式显示设定	模式组的设定显示有无, 由下列的加权的和决定 位0: AUTO/MANUAL显示 无: 0、有: +1 位1: RUN/READY显示 无: 0、有: +2 位3: AT停止/启动显示 无: 0、有: +8 位4: DO锁定解除显示 无: 0、有: +16 位5: 通讯DI1 ON/OFF显示 无: 0、有: +32 其他无效的设定0、+4、+64、+128	255	1
C74	PV/SP值显示设定	基本显示的显示有无, 由下列的加权的和决定 位0: PV显示 无: 0、有: +1 位1: SP显示 无: 0、有: +2 位2: LSP组编号显示 无: 0、有: +4 其他无效的设定0、+8	15	1
C75	操作量显示设定	基本显示的显示有无, 由下列的加权的和决定 位0: MV显示 无: 0、有: +1 位1: 加热 MV/冷却MV显示 无: 0、有: +2 位3: AT进程显示 无: 0、有: +8 其他无效的设定0、+4	15	1
C76	事件设定值显示设定	0: 运行显示时不显示内部事件设定值 1: 运行显示时显示内部事件1设定值 2: 运行显示时显示内部事件1~2设定值 3: 运行显示时显示内部事件1~3设定值	0	1
C77	事件剩余时间显示设定	0: 运行显示时不显示内部事件的ON/OFF延迟剩余时间 1: 运行显示时显示内部事件1的ON/OFF延迟剩余时间 2: 运行显示时显示内部事件1~2的ON/OFF延迟剩余时间 3: 运行显示时显示内部事件1~3	0	1
C78	CT输入电流值显示设定	0: 运行显示时不显示CT的电流值 1: 运行显示时显示CT1电流值 2: 运行显示时显示CT1~2电流值	0	1
C79	显示级别	0: 简单设定 1: 标准设定 2: 多功能设定	0	0
C80	LED监视	0: 不使用 1: RS-485通讯发送时闪烁 2: RS-485通讯接收时闪烁 3: 全DI状态的OR(逻辑和) 4: READY时闪烁	0	2
C90	CT1匝数	0: 800匝 1~40: CT的匝数除以100后的值	8	2
C91	CT1电力线贯通回数	0: 1回 1~6: 回数	1	2
C92	CT2匝数	0: 800匝 1~40: CT的匝数除以100后的值	8	2
C93	CT2电力线贯通回数	0: 1回 1~6: 回数	1	2

(下页续)

■事件组态库

库选择：EUCF

显示	项目	内容	初始值	显示级别
E4.C1 ~ E5.C1	内部事件1~5 组态1 动作种类	0: 无事件 1: PV上限 2: PV下限 3: PV上下限 4: 偏差上限 5: 偏差下限 6: 偏差上下限 7: 偏差上限 (最终SP基准) 8: 偏差下限 (最终SP基准) 9: 偏差上下限 (最终SP基准) 10: SP上限 11: SP下限 12: SP上下限 13: MV上限 14: MV下限 15: MV上下限 16: CT1加热器断线 / 过电流 17: CT1加热器短路 18: CT2加热器断线 / 过电流 19: CT2加热器短路 20: 回路诊断1 21: 回路诊断2 22: 回路诊断3 23: 报警 (状态) 24: READY (状态) 25: MANUAL (状态) 26: 无效 27: AT启动中 (状态) 28: SP斜坡中 (状态) 29: 控制正动作 (状态) 30: ST启动中 (状态) 31: 无效 32: 定时器 (状态) 33: MFB(马达反馈)值上下限(本机无效)	0	0
E4.C2 ~ E5.C2	内部事件1~5 组态2 第1位: 正逆 第2位: 待机 第3位: READY时动作 第4位: 未定义	从右侧开始1、2、3、4位 0: 正 1: 逆 0: 无 1: 待机 2: 待机+SP变更时待机 0: 继续 1: 强制OFF 0	0000 0 0 0 0	0
E4.C3 ~ E5.C3	内部事件1~5 组态3 第1位: 报警OR 第2位: 特殊OFF 第3位: 延时间单位 第4位: 未定义	从右侧开始1、2、3、4位 0: 无 1: 报警正+OR动作 2: 报警正+AND动作 3: 报警逆+OR动作 4: 报警逆+AND动作 0: 通常 1: 事件设定值 (主)=0的场合、事件OFF 0: 0.1s 1: 1s 2: 1min 0	0000 0 0 0 0	2

■DI分配库

库选择：di

显示	项目	内容	初始值	显示级别
d4.1 ~ d13.1	内部接点1~3 动作种类	0: 无功能 1: LSP组选择 (0/+1) 2: LSP组选择 (0/+2) 3: LSP组选择 (0/+4) 4: 无效 5: 无效 6: 无效 7: RUN/READY切换 8: AUTO/MANUAL切换 9: 无效 10: AT停止/启动 11: ST禁止/启动 12: 控制动作正逆切换(与设定一致/与设定相反) 13: SP斜坡许可/禁止 14: PV值保持(不保持/保持) 15: PV最大值保持(不保持/保持) 16: PV最小值保持(不保持/保持) 17: 定时器停止/启动 18: 全DO锁定解除(继续/解除) 19: 无效 20: 无效	0	0
d4.2 ~ d13.2	内部接点1~3 输入位运算	0: 不使用(默认输入) 1: 运算1(A and B) or (C and D) 2: 运算2(A or B) and (C or D) 3: 运算3(A or B or C or D) 4: 运算4(A and B and C and D)	0	2

显示	项目	内容	初始值	显示级别
d4.3 ~ d13.3	内部接点1~3 输入分配A	0: 常开 (OFF、0) 1: 常闭 (ON、1)	2~4	2
d4.4 ~ d13.4	内部接点1~3 输入分配B	2: DI1 3: DI2	0	2
d4.5 ~ d13.5	内部接点1~3 输入分配C	4~9: 未定义 10: 内部事件1 11: 内部事件2	0	2
d4.6 ~ d13.6	内部接点1~3 输入分配D	12: 内部事件3 13: 内部事件4 14: 内部事件5 15~17: 未定义 18: 通讯DI1 19: 通讯DI2 20: 通讯DI3 21: 通讯DI4 22: MANUAL模式 23: READY模式 24: 未定义 25: AT启动中 26: SP斜坡中 27: 未定义 28: 有报警 29: 有PV报警 30: 未定义 31: mode键按键状态 32: 事件输出1端子状态 33: 控制输出1端子状态	0	2
d4.7 ~ d13.7	内部接点1~3 反转A~D 第1位: 反转A (输入分配A反转) 第2位: 反转B (输入分配B反转) 第3位: 反转C (输入分配C反转) 第4位: 反转D (输入分配D反转)	从右侧开始1、2、3、4位 0: 不反转 1: 反转	0000 0 0 0 0	2
d4.8 ~ d13.8	内部接点1~3 反转	0: 不反转 1: 反转	0	2
d4.9 ~ d13.9	内部接点1~3 内部事件 编号指定	0: 所有的内部事件 1~5: 内部事件编号	0	2

■DO分配库

库选择：do

显示	项目	内容	初始值	显示级别
o4.1 ~ o4.2 E4.1 ~ E4.3	控制输出1~2、 事件输出1~3 动作种类	0: 默认输出 1: MV1(ON/OFF控制输出、时间比例输出、加热冷却控制的加热侧时间比例输出) 2: MV2(加热冷却控制的冷却侧时间比例输出) 3: 运算1 ((A and B) or (C and D)) 4: 运算2 ((A or B) and (C or D)) 5: 运算3 (A or B or C or D) 6: 运算3 (A and B and C and D)	0	2
o4.2 ~ o4.2 E4.2 ~ E4.3	控制输出1~2、 事件输出1~3 输出分配A	0: 常开 (OFF、0) 1: 常闭 (ON、1) 2: 内部事件1 3: 内部事件2 4: 内部事件3 5: 内部事件4 6: 内部事件5 7~13: 未定义	14~15 或 2~4	2
o4.3 ~ o4.3 E4.3 ~ E4.3	控制输出1~2、 事件输出1~3 输出分配B	14: MV1 15: MV2 16~17: 未定义 18: DI1 19: DI2	0	2
o4.4 ~ o4.4 E4.4 ~ E4.4	控制输出1~2、 事件输出1~3 输出分配C	20~25: 未定义 26: 内部接点1 27: 内部接点2 28: 内部接点3 29~33: 未定义 34: 通讯DI1 35: 通讯DI2 36: 通讯DI3 37: 通讯DI4 38: MANUAL模式 39: READY模式 40: 未定义 41: AT启动中 42: SP斜坡中 43: 未定义 44: 有报警 45: 有PV报警 46: 未定义 47: mode键按键状态 48: 事件输出1端子状态 49: 控制输出1端子状态	0	2

显示	项目	内容	初始值	显示级别
oEt1.6 ~ oEt2.6 Eo1.6 ~ Eo3.6	控制输出1~2、事件输出1~3 反转A~D	从右侧开始1、2、3、4位	0000	2
	第1位: 反转A	0: 不反转	0	
	第2位: 反转B	1: 反转	0	
	第3位: 反转C		0	
	第4位: 反转D		0	
oEt1.7 ~ oEt2.7 Eo1.7 ~ Eo3.7	控制输出1~2、事件输出1~3 反转	0: 不反转 1: 反转	0	2
oEt1.8 ~ oEt2.8 Eo1.8 ~ Eo3.8	控制输出1~2、事件输出1~3 锁定	0: 无 1: 有(ON时锁定) 2: 有(OFF时锁定、电源投入初始化时除外)	0	2

### ■ 用户功能库

库选择: **UF**

显示	项目	内容	初始值	显示级别
UF-1	用户功能定义1	各设定的第1显示部的显示, 设定例外的内容如下	----	1
UF-2	用户功能定义2	----	----	1
UF-3	用户功能定义3	p-- : 使用中PID组的比例带	----	1
UF-4	用户功能定义4	i-- : 使用中PID组的积分时间	----	1
UF-5	用户功能定义5	d-- : 使用中PID组的微分时间	----	1
UF-6	用户功能定义6	rE-- : 使用中PID组的手动复位	----	1
UF-7	用户功能定义7	oL-- : 使用中PID组的操作量下限	----	1
UF-8	用户功能定义8	oH-- : 使用中PID组的操作量上限	----	1
		p--c : 使用中PID组的冷却侧比例带	----	1
		i--c : 使用中PID组的冷却侧积分时间		
		d--c : 使用中PID组的冷却侧微分时间		
		oL--c : 使用中PID组的冷却侧操作量下限		
		oH--c : 使用中PID组的冷却侧操作量上限		

### ■ 锁定库

库选择: **LoC**

显示	项目	内容	初始值	显示级别
LoC	键锁定	0 : 所有设定可能 1 : 模式、事件、运行显示、SP、UF、锁定、手动MV、mode键的设定可能 2 : 运行显示、SP、UF、锁定、手动MV、mode键的设定可能 3 : UF、锁定、手动MV、mode键的设定可能	0	0
CLoC	通讯锁定	0: RS-485通讯read/write可能 1: RS-485通讯read/write不可	0	2
LLoC	设定器锁定	0: 设定器通讯read/write可能 1: 设定器通讯read/write不可	0	2
PR55	口令显示	0~15 5: 口令1A~2B显示	0	0
PS1R	口令1A	0000~FFFF (16进制数)	0000	0
PS2R	口令2A	0000~FFFF (16进制数)	0000	0
PS1b	口令1B	0000~FFFF (16进制数)	0000	0
PS2b	口令2B	0000~FFFF (16进制数)	0000	0

### ■ 仪表信息库

库选择: **Id**

显示	项目	内容	初始值	显示级别
Id01	ROMID	0固定	—	2
Id02	ROM版本1	XX.XX (小数点以下2位)	—	2
Id03	ROM版本2	XX.XX (小数点以下2位)	—	2
Id04	SLP对应版本		—	2
Id05	EST对应版本		—	2
Id06	日期代码 年	公历-2000 例: 2003年为「3」	—	2
Id07	日期代码 月日	月+(日÷100) 例: 12月1日为「12.01」	—	2
Id08	制造编号		—	2



基于SJ/T11364-2006「电子信息产品污染控制标识要求」的表示样式

此标志表示电子信息产品的环保使用期限, 适用于在中国销售的产品, 其依据是2006年2月28日公布的“电子信息产品污染控制管理办法”与SJ/T11364-2006“电子信息产品污染控制标识要求”。只要遵守此产品相关的安全及使用注意事项, 在从生产日期开始的标识年限内, 便不会因产品中的有害物质发生泄漏或突然异变而对环境、人体或财产造成重大影响。正当使用产品后实施废弃处理时, 请遵从电子信息产品的相关回收再利用法律法规。

有毒有害物质含有表示

零部件名称	有毒有害物质或元素					
	铅 (Pb)	汞 (Hg)	镉 (Cd)	六价铬 (Cr <sup>6+</sup> )	多溴联苯 (PBB)	多溴二苯醚 (PBDE)
电路板组件*1	×	○	○	○	○	○

○: 表示该部件的所有均质材料中, 该有害物质含量均低于SJ/T11363-2006标准所规定的限量要求。  
×: 表示至少在该部件的一种以上的均质材料中, 该有害物质含量超过SJ/T11363-2006标准所规定的限量要求。  
\*1: 电路板组件包括印刷电路板及其构成的零部件, 如电阻、电容、集成电路、连接器等。  
注意: 没有记载于零部件名称的部件的均质材料中, 该有害物质含量均低于SJ/T11363-2006标准所规定的限量要求。

**azbil**

阿自倍尔株式会社  
Advanced Automation Company

本资料所记内容如有变更恕不另行通知